

# INDICE

<b>KIT REPARACION TRANSMISION .....</b>	<b>2</b>
rodamientos para fuelle transmisión .....	26
relación de aplicaciones .....	27
<b>KIT REPARACION CREMALLERA .....</b>	<b>36</b>
relación de aplicaciones .....	47
<b>VARIOS</b>	
abrazaderas para fuelles .....	51
abrazaderas sin fin tipo Norma .....	52
tubo flexible de cartón-aluminio .....	53
tubo de gasolina - servo - agua etc. ....	54
mangueras y codos .....	56
racores y conectores de empalme .....	57
tapones de bloque .....	60
tapones cárter de aceite .....	61
arandelas .....	62
perfiles de carrocería y tuercas de rueda .....	63
poleas de cigueñal .....	64
poleas de alternador y distribución .....	74
botellas de expansión .....	76
tapones de radiador, botella y llenado de aceite ..	81
bioletas cambio PSA .....	84
silentblocs .....	85
piezas varias - tapones de goma .....	87
bioletas de suspensión .....	88
bridas de agua y tapas de termostato .....	92
bujes de rueda .....	97
abrazaderas tubo de escape .....	102
juntas cónicas tubo de escape .....	103
kits montaje colector escape PSA .....	104
latiguillos de freno .....	105
<b>ALFAROMEIO .....</b>	<b>121</b>
<b>AUDI .....</b>	<b>123</b>
<b>BMW .....</b>	<b>149</b>
<b>CITROËN .....</b>	<b>155</b>
<b>FIAT .....</b>	<b>284</b>
<b>FORD .....</b>	<b>328</b>
<b>HYUNDAI/LADA .....</b>	<b>399</b>
<b>LANCIA .....</b>	<b>400</b>
<b>LANDROVER .....</b>	<b>402</b>
<b>MERCEDES BENZ .....</b>	<b>403</b>
<b>MINI (I) .....</b>	<b>422</b>
<b>NISSAN .....</b>	<b>423</b>
<b>OPEL .....</b>	<b>440</b>
<b>PEUGEOT .....</b>	<b>509</b>
<b>RENAULT .....</b>	<b>637</b>
<b>ROVER .....</b>	<b>804</b>
<b>SEAT .....</b>	<b>805</b>
<b>SKODA .....</b>	<b>898</b>
<b>TOYOTA .....</b>	<b>917</b>
<b>VOLKSWAGEN .....</b>	<b>918</b>
<b>RELACION DE REFERENCIAS .....</b>	<b>1029</b>

## KIT REPARACION TRANSMISION

### FUELLES L/RUEDA ESPECIALES PARA MONTAR CON CONO:

Para sustituir el fuelle lado rueda en las transmisiones de Citroën, Renault y Peugeot de trípode (sin homocinética) en las que se debe abrir la transmisión por el lado cambio para montar el fuelle lado rueda, o bien,

Para aquellos casos en que resulte más cómodo aplicar el cono para montar el fuelle que desmontar la junta homocinética (tuercas agarrotadas, clips o seguros que deben reemplazarse, etc.)

Estos fuelles se pueden montar utilizando los conos adecuados y presentan la ventaja frente al "UNIVERSAL" (ver pág. 43) de que su encaje es perfecto ya que son idénticos al original (gargantas, altura, forma, etc.) pero fabricados en neopreno especial de elasticidad 800% que permite su montaje con cono y hace innecesario desmontar la transmisión o la junta homocinética para sustituir el fuelle lado rueda

En estos casos, es indispensable el uso del cono apropiado para cada uno de ellos.

### REFERENCIAS DISPONIBLES DE KITS ESPECIALES PARA MONTAR CON CONO:

(consultar las aplicaciones exactas de cada referencia en los apartados correspondientes a cada marca)

1221-E	Renault 4 - 5 - 6 y 7	CONO DE Ø 78 mm (ref. MC-011)
1273-E	Renault 12 - 14 - 18 - Super5 - Express Citroën Visa - C/15 - LNA Peugeot 205 - 309	CONO DE Ø 88 mm (ref. MC-010)
1274-E	Renault 9 - 18 - Super5 - Express - 21 - 25 Talbot 150 - Solara - Horizon - 1200	CONO DE Ø 88 mm (ref. MC-010)
1557-E	Renault Super5 - Express - 21	CONO DE Ø 88 mm (ref. MC-010)
1696-E	Renault Super5 - Express - Clio - 19	CONO DE Ø 88 mm (ref. MC-010)
1629-E	Renault Trafic - Máster	CONO DE Ø 102 mm (ref. MC-013)
1733-E	Renault Trafic - Máster	CONO DE Ø 102 mm (ref. MC-013)
1488-E	Citroën VISA - C/15	CONO DE Ø 78 mm (ref. MC-011)
1761-E	Citroën C/15	CONO DE Ø 88 mm (ref. MC-010)
1532-E	Citroën AX Peugeot 106	CONO DE Ø 78 mm (ref. MC-011)
1708-E	Citroën ZX - XM - Xantia Peugeot 306 - 309 - 405 - 605	CONO DE Ø 88 mm (ref. MC-010)
1710-E	Peugeot 205 - 309 - 306 Citroën C/15 - ZX	CONO DE Ø 88 mm (ref. MC-010)
1340-E	Citroën BX	CONO DE Ø 88 mm (ref. MC-010)
1493-E	Citroën BX - C/15 - ZX Peugeot 405	CONO DE Ø 88 mm (ref. MC-010)
1342-E	Ford Fiesta 1.3 - Escort 1.6-1.8 Rover 216 - Montego	CONO DE Ø 88 mm (ref. MC-010)
1623-E	Ford Fiesta 1.1	CONO DE Ø 78 mm (ref. MC-011)
1343-E	Opel Corsa Renault Espace - 18 GTX	CONO DE Ø 88 mm (ref. MC-010)
1770-E	Opel Astra	CONO DE Ø 88 mm (ref. MC-010)



## KIT REPARACION TRANSMISION

1359-E	Volkswagen Golf - Polo Opel Kadett 1.6	CONO DE Ø 88 mm (ref. MC-010)
1483-E	furgonetas Mercedes Benz	CONO DE Ø 102 mm (ref. MC-013)
1514-E	Seat Ibiza - Málaga Fiat UNO	CONO DE Ø 78 mm (ref. MC-011)
1575-E	Volkswagen Golf - Ibiza '93 Opel Kadett Renault 21 TXE-D	CONO DE Ø 88 mm (ref. MC-010)
1689-E	Volkswagen Polo	CONO DE Ø 88 mm (ref. MC-010)
1642-E	Audi 80 Volkswagen Passat	CONO DE Ø 88 mm (ref. MC-010)

**IMPORTANTE:** Existen conos en el mercado de diámetro superior al que indicamos para cada aplicación. No podemos garantizar el montaje de estos fuelles si no se usan los conos del diámetro indicado para cada referencia ya que la boca pequeña del fuelle no conseguiría elasticidad suficiente para superar el diámetro del cono.

En tiempo frío es conveniente calentar previamente el fuelle con aire o agua caliente ya que ello mejora la elasticidad y facilita el montaje.

### CONOS APROPIADOS PARA EL MONTAJE DE FUELLES:

#### 011

cono PEQUEÑO para montaje de fuelles, diámetro interior 80 mm (diámetro exterior 84 mm)

#### 010

cono MEDIANO para montaje de fuelles, diámetro interior 90 mm (diámetro exterior 94 mm)

#### 013

cono GRANDE para montaje de fuelles, diámetro interior 102 mm (especial furgonetas, diámetro exterior 106 mm)



### COMPOSICION DE LOS KITS DE FUELLE TRANSMISION:

**GUARDAPOLVO**

**BOLSA DE GRASA 90 ml al BISULFURO DE MOLIBDENO**

**ABRAZADERAS DE ACERO INOXIDABLE DE LONGITUD VARIABLE**  
(una abrazadera corta y una larga cubren toda la gama)



## KIT REPARACION TRANSMISION

### ALFA ROMEO - BMW

### (CITROËN: ver PEUGEOT)



**1359**  
l/rueda  
ALFA 33 1.3 hasta '90

Ø 21-76 mm. Perfil interior liso  
r.o. 0060748291



**1115**  
l/rueda  
ALFA 145-146 1.6-1.8-2.0  
ALFA 147 1.6-2.0  
ALFA 156 todos salvo 2.5JTD y V6

Ø bocas 28-87 mm  
r.o.



**1618**  
l/rueda  
ALFA 33 1.3 desde '90

Ø bocas 21-75 mm  
r.o.



**1996**  
l/rueda  
ALFA 145 - ALFA 146  
todos mods. salvo 2.0

Ø bocas 24-79 mm. Perfil interior liso  
r.o. 60808619



**1575**  
l/rueda  
ALFA 164 2.0  
ALFA 155 salvo 2.5TD

Ø bocas 22-82 mm. Perfil interior liso  
r.o. 16500170470106



**1614**  
l/rueda  
ALFA 164 2.5 - 3.0 V6 - 2.5 TD

Ø bocas 25-86 mm. Perfil interior liso  
r.o. 60510352



**1217**  
l/rueda  
ALFA 145 2.0 - 146 2.0  
ALFA 147 JTD  
ALFA 155 2.5TD

Ø bocas 25-94 mm. Perfil interior liso  
r.o. 60556609



**1611**  
l/cambio  
ALFA 145-146 1.6-1.8-2.0  
ALFA 147 2.0-1.9JTD  
ALFA 155 todos salvo 2.5TD  
ALFA 156 todos salvo 2.4JTD  
Ø bocas 25-62 mm  
r.o. 4315444



**1510**  
l/cambio  
ALFA 164 2.5 - 3.0 V6 - 2.5 TD  
ALFA 75 - 90 (palier trasero)  
ALFA 33

Ø bocas 24-58 mm. Perfil interior liso  
r.o. 60556609



**2308**  
l/cambio  
ALFA 164 2.0

Ø bocas 22-107 mm  
r.o. 16400170470102



**583**  
l/cambio  
ALFA 145 - 146 1.4-1.6  
ALFA 147 1.6  
sin rodamiento

Ø boca 81 mm  
r.o.



**1120**  
l/cambio  
ALFA 145-146 1.4-1.6  
ALFA 147 1.6  
completo con rodamiento Ø 24,5 mm

r.o. 7625541



**1150**  
l/rueda y cambio **BMW** series 3 y 5  
(transmisión trasera)

Ø bocas 30-44 mm  
r.o. 33211229590



**1510**  
l/rueda y cambio **BMW** series 3 y 5  
(transmisión trasera)

Ø bocas 24-58 mm  
r.o. 33211208443

# KIT REPARACION TRANSMISION

## FIAT-LANCIA



**1514-E** (elástico-cono)  
l/rueda

UNO todos salvo i.e. -FIORINO  
REGATA hasta 10/'87  
DELTA-PRISMA  
Ø bocas 21-72 mm. Perfil interior una  
garganta, r.o. 5987092



**1514**  
l/rueda

UNO todos salvo i.e. -FIORINO  
REGATA 1.7 dhasta 10/'87  
DELTA-PRISMA  
Ø bocas 21-72 mm. Perfil interior una  
garganta, r.o. 5987092



**1577**  
l/rueda  
UNO Turbo i.e. hasta '88  
TIPO/TEMPRA 1.7D  
DELTA/PRISMA D-TD

Ø bocas 25-74 mm. Perfil interior liso  
r.o. 7578083



**1578**  
l/rueda  
REGATA 70-85 y 1.7D desde '88  
Y-10  
CINQUECENTO-900  
SEICENTO  
Ø bocas 21-76 mm. Perfil interior liso  
r.o. 7642776



**1613**  
l/rueda  
CROMA hasta '87

Ø bocas 24-85 mm. Perfil interior liso  
r.o. 82403486



**1614**  
l/rueda  
CROMA desde '87  
TIPO TD con ABS  
DEDRA-THEMA 1.8 y TD  
PUNTO-II 1.8-1.9JTD  
Ø bocas 25-86 mm.  
r.o. 82443750



**1618**  
l/rueda  
TIPO/TEMPRA 1.4-1.6-1.9DIESEL  
DEDRA-THEMA 1.6  
DEDRA 2.0  
PUNTO-II 1.2-1.9D  
Ø bocas 21-75 mm  
r.o. 7635255



**1619**  
l/rueda  
TIPO/TEMPRA 1.9 TD sin ABS  
  
Ø bocas 24-70 mm  
r.o. 82443745



**1996**  
l/rueda  
PUNTO (salvo GT/TD desde '96)  
BRAVO/A todos salvo 2.0  
ULYSSE-SCUDO 1.6-1.8  
MULTIPLA 1.6-DOBLO 1.2-1.9D  
Ø bocas 24-79 mm  
r.o. 7761570



**1217**  
l/rueda  
ULYSSE-SCUDO 1.9TurboD  
  
Ø bocas 26-94 mm  
r.o.



**1520**  
l/rueda  
ULYSSE-SCUDO 1.6-1.8  
  
Ø bocas 27-90 mm  
r.o.



**1222**  
l/rueda  
ULYSSE-SCUDO 1.9Diesel  
  
Ø bocas 38-83 mm  
r.o.

















**1499**  
l/rueda  
SCUDO 2.0JTD (HDi)  
  
Ø bocas 29-97 mm  
r.o.



**1115**  
l/rueda  
BRAVO 2.0  
MAREA 1.8-2.0-1.9TD  
MULTIPLA 1.9JTD  
PUNTO GT-TD desde '96  
  
Ø bocas 28-87 mm  
r.o.

## KIT REPARACION TRANSMISION

### FIAT-LANCIA

 <p><b>1579</b> 1/rueda DUCATO hasta '94</p> <p>Ø bocas 23-94 mm r.o.</p>	 <p><b>1225</b> 1/rueda DUCATO 1.000-1.400Kg desde '94</p> <p>Ø bocas 23-94 mm r.o. 9564478680</p>
 <p><b>2307</b> 1/rueda DUCATO 1.800Kg desde '94 a '97</p> <p>Ø bocas 33-112 mm r.o. 9564478780</p>	 <p><b>1391</b> 1/rueda DUCATO 1.800Kg desde '97</p> <p>Ø bocas 33-110 mm r.o.</p>
 <p><b>1432</b> 1/rueda DOBLO 1.9JTD</p> <p>Ø bocas 24-82 mm r.o.</p>	 <p><b>1568</b> 1/cambio transm. izquierda de 11/'84 a 2/'86 UNO-REGATA salvo i.e. y 100 S DELTA - PRISMA salvo i.e. y TD</p> <p>Ø retén 23 mm, boca 70 mm r.o. 92601255</p>
 <p><b>1622</b> transm. izquierda de 2/'86 a 10/'87 UNO-REGATA (salvo i.e. y 100 S) DELTA-PRISMA (salvo i.e. y TD) FIORINO</p> <p>Ø retén de 23 mm, boca 81 mm r.o. 92601366</p>	 <p><b>1611</b> 1/cambio UNO Turbo i.e. - REGATA 100 S DELTA TurboDiesel, i.e. y HF DEDRA 1.8 - 2.0 y TurboDiesel BRAVO/A-MAREA-PUNTO TD PUNTO-II 1.8-1.9JTD Ø bocas 25-62 mm r.o. 4315444</p>
 <p><b>1583</b> 1/cambio tr. izquierda desde 10/'87 UNO-REGATA (salvo i.e. y 100S) TIPO-TEMPRA-BRAVO/ADch+Izq DELTA - PRISMA (salvo i.e. y TD) DEDRA 1.6- Y10 con rodamiento de Ø 23.0 mm r.o. 7625541</p>	 <p><b>0583</b> 1/cambio tr. izquierda desde 10/'87 UNO-REGATA (salvo i.e. y 100S) TIPO-TEMPRA-BRAVO/ADch+Izq DELTA - PRISMA (salvo i.e. y TD) DEDRA 1.6- Y10 sin rodamiento r.o.</p>
 <p><b>1599</b> 1/cambio tr. derecha desde 10/'87 UNO-REGATA (salvo i.e. y 100 S) FIAT CINQUECENTO 900cc DELTA - PRISMA (salvo i.e. y TD) DEDRA 1.6- Y10 con rodamiento de Ø 23.0 mm r.o. 7921245</p>	 <p><b>0349</b> 1/cambio tr. derecha desde 10/'87 UNO-REGATA (salvo i.e. y 100 S) FIAT CINQUECENTO 900cc DELTA - PRISMA (salvo i.e. y TD) DEDRA 1.6- Y10 sin rodamiento r.o.</p>
 <p><b>1120</b> 1/cambio BRAVO-BRAVA 1.4-1.6 desde '96 MAREA 1.6 - MULTIPLA 1.6 PUNTO- TD desde '96 PUNTO-II 1.9D-1.2 PALIO 1.2-DOBLO 1.2-1.9D con rodamiento de Ø 24.5 mm r.o.</p>	 <p><b>1079</b> 1/cambio PUNTO-I 55-60-90-75-85-90-D PUNTO-II 1.2-1.9D MULTIPLA 1.9JTD</p> <p>Ø bocas 21-66 mm r.o.</p>



## KIT REPARACION TRANSMISION

### FIAT-LANCIA



**1362**  
l/cambio  
SCUDO 1.6-1.8-2.0  
DUCATO 1.000-1.400 Kg desde '94

Ø bocas 22-77 mm  
r.o.



**1213**  
l/cambio  
SCUDO 1.9D-TD-2.0HDi

Ø bocas 34-76 mm  
r.o.



**1580**  
l/cambio  
DUCATO hasta '94

Ø bocas 23-96 mm  
r.o.



**1407**  
l/cambio  
DUCATO 1.800 Kg desde '94

Ø bocas 33-88 mm  
r.o.



**1148**  
l/cambio  
DOBLO 1.9JTD

Ø bocas 22-69 mm (trilobulado)  
r.o.

## KIT REPARACION TRANSMISION

### FORD (lado rueda)

 <p><b>1623-E</b> (elástico-cono) <b>1623</b> (normal) 1/rueda FIESTA 950 - 1100 ESCORT 1100</p> <p>Ø bocas 20-68 mm r.o. 6028724</p>	 <p><b>1342-E</b> (elástico-cono) <b>1342</b> (normal) 1/rueda FIESTA 1.3-1.4-1.6-1.6D-1.8D-1.25 ESCORT-ORION 1.3-1.4-1.6-1.6D-1.8 ESCORT 1.8D - 1.8 EFI (salvo 16v) FIESTA '96 1.25-1.4-1.8D Ø bocas 20-78 mm. Una garganta r.o. 6043191</p>
 <p><b>2451</b> 1/rueda ESCORT 1.8 motor ZETEC-16v ESCORT 1.8 Diesel y TurboD d/ '91 ESCORT 2.0 OHC y RS Turbo</p> <p>Ø bocas 25-90 mm. Una garganta r.o. 6676136</p>	 <p><b>1624</b> 1/rueda y cambio SIERRA-SCORPIO (transm. trasera)</p> <p>Ø bocas 22-49 mm. Una garganta r.o. 6127557</p>
 <p><b>1993</b> 1/rueda MONDEO (homocinética de Ø 80 mm)</p> <p>fabricado en neopreno Ø bocas 22-78 mm. Perfil interior liso r.o. 6757617</p>	 <p><b>1994</b> 1/rueda MONDEO (homocinética de Ø 87 mm)</p> <p>fabricado en neopreno Ø bocas 22-84 mm. Perfil liso r.o. 6757618</p>
 <p><b>1184</b> 1/rueda MAVERICK</p> <p>Ø bocas 23-95 mm r.o.</p>	 <p><b>1284</b> 1/rueda PROBE</p> <p>Ø bocas 23-90 mm r.o. 3395850</p>
 <p><b>1075</b> 1/rueda FIESTA '96 1.3BL</p> <p>Ø bocas 24-58 mm r.o.</p>	 <p><b>1298</b> 1/rueda FOCUS</p> <p>Ø bocas 31-76 mm r.o.</p>
 <p><b>1373</b> 1/rueda KA</p> <p>Ø bocas 24-73 mm r.o.</p>	 <p><b>1225</b> 1/rueda GALAXY</p> <p>Ø bocas 29-98 mm r.o.</p>

## KIT REPARACION TRANSMISION

### FORD (lado cambio)

 <p><b>1341</b> l/cambio FIESTA 950-1100-1.6D-1.8D hasta '92 ESCORT 1.1-1.6D-1.8D hasta '92 ORION 1.6 D-1.8D hasta '92</p> <p>Ø bocas 20-68 mm. Una garganta r.o. 6028751</p>	 <p><b>1342</b> l/cambio FIESTA 1.3-1.4-1.6-XR2 hasta '95 ESCORT 1.3-1.4-1.6-XR3-1.8-2.0-RS ORION todos hasta '92</p> <p>Ø bocas 20-78 mm. Una garganta r.o. 6043191</p>
 <p><b>1186</b> l/cambio FIESTA todos (gasolina) desde '96 hasta '97</p> <p>Ø bocas 23-95 mm r.o. 1016772</p>	 <p><b>1227</b> l/cambio ESCORT Diesel y TurboD desde '92 COURIER 1.8 Diesel TRANSIT '00-</p> <p>Ø bocas 24-78 mm (trípode) r.o. 6676140</p>
 <p><b>1079</b> l/cambio KA FIESTA '96 desde '97</p> <p>Ø bocas 21-66 mm r.o.</p>	 <p><b>1049</b> l/cambio FOCUS-CONNECT</p> <p>Ø bocas 29-62 mm r.o.</p>
 <p><b>1142</b> l/cambio FIESTA '02- FUSION</p> <p>Ø bocas 19-60 mm r.o. 4705777</p>	 <p><b>1145</b> l/cambio FIESTA '02- FUSION</p> <p>Ø bocas 21-60 mm r.o.</p>
 <p><b>1069</b> l/cambio GALAXY</p> <p>Ø bocas 24-57 mm r.o.</p>	 <p><b>1053</b> l/cambio CONNECT</p> <p>Ø bocas 21-70 mm r.o. 4371803</p>

## KIT REPARACION TRANSMISION

### HONDA - HYUNDAI - ISUZU - JEEP - LADA - MAZDA

 <p><b>2373</b> 1/rueda HONDA CIVIC-CONCERTO</p> <p>Ø bocas 23-83 mm. Liso r.o. 44333-SR3-013</p>	 <p><b>1284</b> 1/rueda HONDA ACCORD</p> <p>Ø bocas 23-90 mm. Liso r.o. 44333-SM4-003</p>
 <p><b>1216</b> 1/rueda HYUNDAI PONY - COUPE - EXCEL LANTRA - ACCENT</p> <p>Ø bocas 23-80 mm. Liso r.o. F00122400</p>	 <p><b>1959</b> 1/rueda HYUNDAI PONY - COUPE - EXCEL LANTRA - ACCENT</p> <p>Ø bocas 21-73 mm. Liso r.o. F00122530</p>
 <p><b>1198</b> 1/rueda ISUZU TROOPER</p> <p>Ø bocas 25-85 mm r.o. 894313080</p>	 <p><b>2374</b> 1/rueda JEEP GRAND CHEROKEE</p> <p>Ø bocas 23-82 mm r.o. 4796233</p>
 <p><b>1852</b> 1/rueda LADA NIVA</p> <p>Ø bocas 18-81 mm. Liso r.o. 2121-2215030</p>	 <p><b>1359</b> 1/rueda y cambio LADA SAMARA</p> <p>Ø bocas 20-76 mm. Liso r.o. 2108-2215030/2108-2215068</p>
 <p><b>1613</b> 1/cambio LADA NIVA</p> <p>Ø bocas 24-85 mm. Liso r.o. 2121-2215031</p>	 <p><b>1964</b> 1/rueda MAZDA 323 1.6</p> <p>Ø bocas 24-82 mm. Una garganta r.o. G01222540A</p>
 <p><b>1493</b> 1/rueda MAZDA 323 1.8</p> <p>Ø bocas 20-80 mm. Liso r.o. F01522530A</p>	



## KIT REPARACION TRANSMISION

### MERCEDES BENZ



**1783**  
l/rueda y cambio, transmisión trasera  
MERCEDES BENZ (turismos)

Ø bocas 22-65 mm. Liso  
r.o. 1243500117



**1066**  
l/rueda y cambio, transmisión trasera  
MERCEDES BENZ (turismos)

Ø bocas 22-57 mm. Liso  
r.o.



**1483-E (elástico-cono)**  
**1483 (normal)**  
l/rueda  
furgoneta MB

Ø bocas 24-90 mm. Doble garganta  
r.o. 631330185



**1482**  
l/cambio  
furgoneta MB

Ø bocas 27-83  
r.o. 631330085



**1187**  
l/rueda  
MERCEDES VITO-SPRINTER  
(en neopreno)

Ø bocas 24-92 mm. Una garganta  
r.o.



**1750**  
l/rueda  
MERCEDES VITO-SPRINTER  
(en termoplástico)

Ø bocas 29-100 mm. Liso  
r.o.



**1794**  
l/cambio  
MERCEDES VITO-SPRINTER

Ø bocas 23-70 mm. Liso  
r.o.



**1134**  
l/rueda  
MERCEDES CLASE A

Ø bocas 32-76 mm  
r.o. 168 360 00 68



**1149**  
l/rueda y cambio  
MERCEDES CLASE C

Ø bocas 28-57 mm  
r.o. 201 350 08 37

## KIT REPARACION TRANSMISION

### MITSUBISHI-NISSAN

 <p><b>1961</b> 1/rueda MITSUBISHI MONTERO - PAJERO</p> <p>Ø bocas 24-86 mm. Liso r.o. 44333-SR3-013</p>	
 <p><b>2378</b> 1/rueda NISSAN MICRA 1.0</p> <p>Ø bocas 19-67 mm. Liso r.o. 39241-01M00/39241-01M25</p>	 <p><b>1181</b> 1/rueda NISSAN MICRA 1.3 NISSAN PRIMERA 1.6 NISSAN ALMERA 1.4</p> <p>Ø bocas 21-77 mm. Liso r.o. 39241-4F425</p>
 <p><b>1818</b> 1/rueda NISSAN PRIMERA 2.0 NISSAN ALMERA 1.6 y DIESEL</p> <p>Ø bocas 22-88 mm r.o. 39241-71J25</p>	 <p><b>1960</b> 1/rueda NISSAN SUNNY</p> <p>Ø bocas 25-85 mm. Liso r.o. 39241-17R85</p>
 <p><b>1342-E (elástico-cono)</b> <b>1342 (normal)</b> 1/rueda NISSAN BLUEBIRD</p> <p>Ø bocas 20-78 mm r.o. 39241-16E25</p>	 <p><b>1184</b> 1/rueda NISSAN TERRANO-2</p> <p>Ø bocas 23-95 mm. Liso r.o. 39241-10E25</p>







## KIT REPARACION TRANSMISION

### OPEL (lado rueda)

 <p><b>1343-E</b> (elástico-cono) <b>1343</b> (normal) l/rueda CORSA-A (1983-1993)</p> <p>Ø bocas 22-77 mm. Una garganta r.o. 374094</p>	 <p><b>1359-E</b> (elástico-cono) <b>1359</b> (normal) l/rueda KADETT 1.3 KADETT 1.6 (motor SV) ASCONA 1.6</p> <p>Ø bocas 20-76 mm. Liso r.o. 374019</p>
 <p><b>1989</b> l/rueda CORSA-B (1993-2000) ASTRA-G 1.4-1.6 / ZAFIRA 1.4-1.6 VECTRA-B 1.6</p> <p>Ø bocas 22-82 mm r.o. 374102</p>	 <p><b>1575-E</b> (elástico-cono) <b>1575</b> (normal) l/rueda KADETT 1.6 - 1.6 D - 1.7 D - 1.8 y 2.0 (salvo 1.6 motor SV) ASCONA Diesel - 1.8 y 2.0 CALIBRA - VECTRA-A</p> <p>Ø bocas 22-82 mm r.o. 374050</p>
 <p><b>1770-E</b> (elástico-cono) <b>1770</b> (normal) l/rueda ASTRA-F 1.4 KADETT 1.4</p> <p>Ø bocas 20-76 mm. Liso r.o. 374190</p>	 <p><b>1112</b> l/rueda ASTRA-G 1.2 CORSA-C gasolina</p> <p>Ø bocas 22-82 mm r.o.</p>
 <p><b>1175</b> l/rueda VECTRA-B 1.8-2.0-1.7TD-2.0TD ASTRA-G 1.8-2.0-1.7TD-2.0TD ZAFIRA 1.8-2.0-1.7TD-2.0TD</p> <p>Ø bocas 26-90 mm. Doble garganta r.o. 374040</p>	 <p><b>1198</b> l/rueda FRONTERA MONTERREY</p> <p>Ø bocas 25-85 mm. Liso r.o. 301401</p>
 <p><b>1921</b> l/rueda CORSA-C Diesel</p> <p>Ø bocas 26-77 mm. Liso r.o.</p>	















## KIT REPARACION TRANSMISION

### OPEL (lado cambio)

 <p><b>1344</b> l/cambio CORSA-A (salvo 1.6GSi) CORSA-B CORSA-C gasolina</p> <p>Ø bocas 22-77 mm r.o. 374101</p>	 <p><b>1490</b> l/cambio CORSA-A 1.6 GSi KADETT 1.3 y 1.6 motor SV ASTRA F 1.7D ASTRA-G 1.2-1.4-1.6-1.7DTL VECTRA-B 1.6 Ø bocas 20-54 mm. Liso r.o. 374018</p>
 <p><b>1730</b> l/cambio KADETT 1.6(motor SH)-1.7D-1.8-2.0 VECTRA-A - CALIBRA ASCONA ASTRA F 1.4-1.6.1.8-2.0</p> <p>Ø bocas 20-76 mm. Liso r.o.</p>	 <p><b>1114</b> l/cambio VECTRA-B 1.8-2.0-1.7TD-2.0TD ASTRA-G 1.8-2.0-2.0DTL ZAFIRA 1.8-2.0-2.0DTL</p> <p>Ø bocas 25-65 mm. Liso r.o.</p>
 <p><b>1147</b> l/cambio (trilobulado) CORSA-C gasolina</p> <p>Ø bocas 22-66 mm r.o. 1603004-1603230</p>	 <p><b>1148</b> l/cambio (trilobulado) CORSA-C 1.7Diesel</p> <p>Ø bocas 22-69 mm. r.o. 1603260</p>

## KIT REPARACION TRANSMISION

### PEUGEOT - CITROËN (lado rueda)

	<p><b>1273-E</b> (elástico-cono) <b>1273</b> (normal) l/rueda 205 - 309 todos hasta 12/'86 C15 gasolina desde '89 VISA</p> <p>Ø bocas 19-78 mm. Doble garganta r.o. 3293.41 - 3293.74</p>		<p><b>1710-E</b> (elástico-cono) <b>1710</b> (normal) l/rueda 205 - 309 todos desde 12/'86 (salvo GTI, TurboDiesel y 205 Aut.) 106 1.4 SXI, AX-GTi, ZX 1.4 C15 D desde PR4928 ('93) hasta '95 Ø bocas 19-81 mm. Una garganta r.o. 3293.77</p>
	<p><b>1493-E</b> (elástico-cono) <b>1493</b> (normal) l/rueda 205 Autom.-405 salvo TD hasta '93 C15 D hasta '93 ZX 1.6-1.9 hasta '93 XANTIA 1.6-1.8 hasta '97 Ø bocas 20-80 mm. Perfil interior liso r.o. 3293.83</p>		<p><b>1708-E</b> (elástico-cono) <b>1708</b> (normal) l/rueda BX 1.9i-TD 205-309 GTI y TurboD, XM-605 2.0 405 SRI - M116 y TurboD hasta '92 ZX 1.6(ABS)-1.8-2.0-TurboD y 16v hasta '95. XANTIA D-TD hasta '97 Ø bocas 19-86 mm. Perfil interior liso r.o. 3293.80 - 3293.91</p>
	<p><b>1532-E</b> <b>1532</b> (normal) l/rueda 106 todos salvo 1.4 SXI AX salvo GTi</p> <p>Ø bocas 19-69 mm. Una garganta r.o. 3293.81</p>		<p><b>2305</b> l/rueda 306 1.4-1.6 / 605 - XM 2.0 ZX 1.6/1.8 y 1.9D desde '95 405 desde '93 XANTIA (izqda.) 1.6-1.8-D-TD d/'97 Ø bocas 25-90 mm. En neopreno r.o. 3293.96</p>
	<p><b>1432</b> l/rueda BERLINGO-PARTNER 1.1-1.4 con ABS hasta '98 306 1.4 con ABS hasta '98</p> <p>Ø bocas 24-82 mm. r.o. 3293.14</p>		<p><b>1218</b> l/rueda SAXO 1.1 transm. derecha 106 1.1 desde '96 transm. derecha (rueda de 3 agujeros)</p> <p>Ø bocas 19-69 mm. r.o. 3293.11</p>
	<p><b>1521</b> l/rueda C15 desde '95 - 205 desde '95 AX desde '94 - 106 1.4 desde '95 BERLINGO-PARTNER 1.1-1.4 sin ABS hasta '98 / 106-1.4-1.6 desde '93 SAXO 1.6 - XSARA 1.4-1.6 hasta '99 306 1.4 (sin ABS)-1.6 Ø bocas 22-82 mm.</p>		<p><b>1460</b> l/rueda XANTIA 2.0-2.0HDi-2.1TD tr. dcha. XSARA 1.9D desde '99 406 2.1TD-2.0HDi 407 2.0HDi-2.2HDi</p> <p>Ø bocas 39-98 mm.</p>
	<p><b>1427</b> l/rueda BERLINGO-PARTNER 1.1-1.4 d/'98 XSARA 1.4-1.6 desde '99 206 1.1-1.4-1.6 306 1.4-1.6 desde '98</p> <p>Ø bocas 34-76 mm. r.o.</p>		<p><b>1433</b> l/rueda SAXO 1.1-1.4-1.5D tr. izquierda 106 1.1-1.4-1.5D desde '96 tr. izqda.</p> <p>Ø bocas 23-75 mm. r.o.</p>
	<p><b>1434</b> l/rueda SAXO 1.4-1.5D transm. derecha 106 1.4-1.5D desde '96 tr. derecha</p> <p>Ø bocas 29-75 mm. r.o.</p>		<p><b>1225</b> l/rueda BOXER-JUMPER 1.000-1.400 Kg XANTIA 2.0-2.0HDi-2.1TD tr. izqda.</p> <p>Ø bocas 29-98 mm r.o. 3293.98</p>



## KIT REPARACION TRANSMISION

### PEUGEOT - CITROËN (lado rueda)

 <p><b>1391</b> 1/rueda BOXER-JUMPER 1.800 Kg desde '96</p> <p>Ø bocas 33-110 mm. r.o.</p>	 <p><b>1520</b> 1/rueda JUMPY-EVASION-EXPERT-806 1.6-1.8 (cambio BE3)</p> <p>Ø bocas 27-90 mm. r.o.</p>
 <p><b>1499</b> 1/rueda JUMPY-EVASION-EXPERT-806 2.0HDi</p> <p>Ø bocas 28-98 mm. r.o.</p>	 <p><b>1217</b> 1/rueda JUMPY-EVASION-EXPERT-806 1.9 TurboD (salvo HDi)</p> <p>Ø bocas 26-94 mm. r.o. 3293.00</p>
 <p><b>1222</b> 1/rueda BERLINGO-PARTNER 1.8-1.9D-HDi JUMPY-EVASION-EXPERT-806 1.9D XANTIA (dcha.) 1.6-1.8-D-TD d/'97 XSARA 1.8-2.0-1.9D/TD-2.0HDi PICASSO 1.4-1.6 - 206 1.9D-HDi-2.0 306 1.8-2.0-1.9D-TD-HDi Ø bocas 38-83 mm.</p>	 <p><b>1943</b> 1/rueda XM TurboD 605 TurboD</p> <p>Ø bocas 26-97 mm. r.o.</p>
 <p><b>1579</b> 1/rueda J5 - C25</p> <p>Ø bocas 23-94 mm r.o. 3293.42</p>	 <p><b>2307</b> 1/rueda BOXER-JUMPER 1.800 Kg hasta '96</p> <p>Ø bocas 33-112 mm r.o. 3293.88</p>
 <p><b>1996</b> 1/rueda JUMPY-EVASION-EXPERT-806 1.6-1.8 (cambio BE3)</p> <p>Ø bocas 24-79 mm r.o. 3293.01</p>	 <p><b>1363</b> 1/rueda GS-GSA 2CV -DYANE - MEHARI (con transmisión de bolas)</p> <p>Ø bocas 20-75 mm. Liso r.o. 95532941</p>
 <p><b>1569</b> 1/rueda 2CV -DYANE - MEHARI (con transmisión de cruceta)</p> <p>r.o. AM-373 99</p>	 <p><b>1570</b> intermedio 2CV -DYANE - MEHARI (con transmisión de cruceta)</p> <p>Ø bocas 20-37 mm r.o. AM-372 88A</p>
 <p><b>1488-E (elástico-cono)</b> 1/rueda VISA 652-1360 cc C15 gasolina hasta '89 (motor plano)</p> <p>Ø bocas 19-73 mm. Liso r.o. 95532950</p>	 <p><b>1761-E (elástico-cono)</b> 1/rueda C15 gasolina desde '89</p> <p>Ø bocas 19-78 mm. <b>Una garganta</b> r.o. 9403293778</p>

## KIT REPARACION TRANSMISION

### PEUGEOT - CITROËN (lado rueda y cambio)

	<p><b>1340E</b> l/rueda BX (salvo 1.9i y TD)</p> <p>r.o.</p>		<p><b>1109</b> l/rueda 206 1.1-1.4i-1.4HDi desde 1/03- C2-C3 1.1-1.4-1.6/16v-1.4HDi</p> <p>Ø31-74 mm r.o. 3293.35</p>
	<p><b>1113</b> l/rueda 206 1.6HDi-1.6/16v-2.0/16v d/2/01- Xsara-307 2.0HDi desde 2/01- C4-C5 407 1.2-2.0-1.6HDi</p> <p>Ø34-85 mm r.o. 3293.31</p>		
	<p><b>1571</b> l/cambio 2CV - DYANE - MEHARI (con transmisión de cruceta)</p> <p>r.o AZ 373 88A</p>		<p><b>1556</b> l/cambio BX-14 C15 gasolina hasta '89 (motor plano) VISA 1118-1124-1219-1360cc</p> <p>cárter de Ø 70 mm, largo 78 mm r.o. 95565567</p>
	<p><b>1533</b> l/cambio 205 desde '89 / C15 motor TU 106-AX 1.1-1.4-1.6 y D C15 Diesel desde '93 / ZX 1.4 BERLINGO-PARTNER 1.1-1.4h/'98 SAXO 1.4-1.5D - XSARA 1.4-1.6h/'98 cárter de Ø 70 mm, largo 87 mm r.o. 3287.69</p>		<p><b>1606</b> l/cambio 106 - 1.0 y 1.1 AX 1.0 SAXO 1.0-1.1</p> <p>cárter de Ø 63 mm, largo 85 mm r.o. 3287.75</p>
	<p><b>1362</b> l/cambio 205 hasta '86 - 309 GTi-TurboD 405 SRi-MI16-TurboD hasta '93 C15 D hasta '93 ZX 1.6-1.9-2.0-1.9D-1.9TD hasta '93 JUMPY-EXPERT salvo 1.9D JUMPER-BOXER 1.000-1.400 Kg Ø bocas 22-77 mm. r.o. 3293.59</p>		<p><b>1626</b> l/cambio 205-309 desde '86 hasta '89 405 GL-GR hasta '93 C15 D desde '89 a '93</p> <p>Ø bocas 20-69 mm r.o.</p>
	<p><b>1839</b> l/cambio 405 desde '93 - 605 / XM 2.0 XANTIA(izqd) 1.6-1.8-1.9D/TDh/'97 605 / XM 2.0 - Diesel y V6 ZX 1.6-1.8-1.9D-TD desde '93 a '95 C15 desde '95 Ø bocas 22-65 mm r.o. 3287.76 - 3287.79</p>		<p><b>1213</b> 206 1.9D-HDi-2.0/307 1.6-2.0-HDi 306/406 1.8-2.0-Diesel-TurboD y 16v JUMPY-EXPERT-806-EVASION 1.9D XANTIA(dcha) 1.6-1.8-1.9D/TD d/'97 ZX 1.6-1.8-1.9D-TD desde '95 XSARA 1.8-2.0-1.9D/TD-407 1.8-2.0 Ø bocas 34-76 mm r.o. 3287.81</p>
	<p><b>1580</b> l/cambio J5 - C25</p> <p>Ø bocas 23-96 mm r.o. 3287.49</p>		<p><b>1407</b> l/cambio JUMPER-BOXER 1.800 Kg</p> <p>Ø bocas 33-88 mm r.o.</p>

## KIT REPARACION TRANSMISION











### PEUGEOT - CITROËN (lado cambio)

 <p><b>1428</b> 1/cambio BERLINGO-PARTNER 1.1-1.4 d/'98 XSARA 1.4-1.6 desde '98 206 1.1-1.4-1.6 306 1.4-1.6 desde '98 307 1.4 gasolina Ø bocas 28-62 mm r.o.</p>	 <p><b>1537</b> 1/cambio SAXO 1.6 106 1.6 desde '96  <b>con rodamiento Ø 25,80 mm</b> r.o. 3287.89</p>
 <p><b>1741</b> 1/cambio XANTIA(izqd) 2.0-2.1TD-HDi  Ø bocas 23-96 mm r.o.</p>	 <p><b>1467</b> 1/cambio XANTIA(dcha) 2.0-2.1TD-HDi 406 2.1TD - 2.0HDi  Ø bocas 33-88 mm r.o.</p>
 <p><b>1110</b> 1/cambio XANTIA 2.0-2.0HDi-2.1TD XSARA 1.9D desde '99 406 2.1TD-2.0HDi SAXO 1.6 - XSARA 1.4-1.6 hasta '99 307-407 2.0/2.2HDi/16v Ø bocas 39-76 mm. r.o. 3287.A4-3287.96</p>	 <p><b>1122</b> 1/cambio C5  Ø bocas 38-70 mm r.o. 3287.91</p>
 <p><b>1142</b> 1/cambio C2-C3  Ø bocas 19-60 mm r.o. 3287.94</p>	















## KIT REPARACION TRANSMISION

### RENAULT

	<p><b>1221-E</b> (elástico-como) <b>1221</b> (normal) l/rueda R 4 - R 5 - R 6 - R 7</p> <p>Ø bocas de 16-69 mm. Doble garganta r.o. 7701013273</p>		<p><b>1273-E</b> (elástico-como) <b>1273</b> (normal) l/rueda R 12 - R 14 - R 18 Diesel (Ø 26 mm) EXPRESS Diesel - SUPER 5 Diesel</p> <p>Ø bocas 20-78 mm. Doble garganta r.o. 7701200694</p>
	<p><b>1274-E</b> (elástico-como) <b>1274</b> (normal) l/rueda R 9/11 Diesel (Ø 35 mm) - R 18 SUPER 5 y EXPRESS gasolina (transm. izquierda) salvo Turbo y 1.1 R 21 GTS (tr. izquierda)-R-25 TS-GTS Ø bocas 28-78 mm. Doble garganta r.o. 7701348568</p>		<p><b>1557-E</b> (elástico-como) l/rueda SUPER 5 gasolina (tr. derecha) EXPRESS gasolina (transm. derecha) R-9/11 TXE (transm. derecha) R-21 GTS (transm. derecha) Ø bocas 28-78 mm. Doble garganta r.o. 7700348568</p>
	<p><b>1343</b> l/rueda R 18 GTX desde '84 SPACE modelo '84</p> <p>Ø bocas 22-78 mm. Una garganta r.o. 7701202652</p>		<p><b>1628</b> l/rueda R 9/ 11 Diesel (palier de Ø 40 mm) R 18 Diesel (palier de Ø 40 mm)</p> <p>Ø bocas 35-78 mm. Doble garganta r.o.</p>
	<p><b>1696-E</b> (elástico-cono) l/rueda SUPER 5 1.1 EXPRESS gasolina, cambio de 4v. R 19 1.2 TL. CLIO 1.1</p> <p>Ø bocas 22-78 mm. Doble garganta r.o. 7701464551</p>		<p><b>1575-E</b> (elástico-como) <b>1575</b> (normal) l/rueda R-21 TXE y Diesel con transmisión Ayra o GKN</p> <p>Ø bocas 22-81 mm. Liso r.o. 7701464775</p>
	<p><b>1732-E</b> (elástico-como) <b>1732</b> (normal) l/rueda R 21 TXE y Diesel con trans. Löbro CLIO 1.7/1.8</p> <p>Ø bocas 22-81 mm. Una garganta r.o. 7701033432 - 7701035088</p>		<p><b>1693</b> l/rueda R 25 TX - GTX - Diesel y TurboD</p> <p>Ø bocas 22-85 mm. Una garganta r.o. 7701202743</p>
	<p><b>1431</b> l/rueda CLIO 1.2/1.4 (homocinética Ø 70 mm)</p> <p>Ø bocas 33-70 mm r.o. 7701466120</p>		<p><b>1517</b> l/rueda R 19 1.4-1.7-1.8-16v R 19 Diesel, transmisión izquierda EXPRESS desde '92, R 21 TXE d/'92 LAGUNA-SPACE desde '92</p> <p>Ø bocas 27-85 mm. r.o. 7701035380</p>
	<p><b>1555</b> l/rueda R 19 Diesel transmisión derecha R 21 GTS (desde '92) - CLIO Diesel MEGANE 1.4-1.6 y Diesel</p> <p>Ø bocas 33-82 mm r.o. 7701466122</p>		<p><b>1432</b> l/rueda R 21 TXE y Diesel desde '92 CLIO 1.2-1.4, homocinética de Ø 82 MEGANE 2.0-TWINGO-MEGANE II SAFRANE KANGOO con palier de Ø 31 mm Ø bocas 24-82 mm r.o. 7701034800 - 7701467125</p>

# KIT REPARACION TRANSMISION

## RENAULT

 <p><b>1520</b> l/rueda R 25 TurboDX - TX - GTX desde '90 TRAFIC - MASTER desde '92 ESPACE-II/III/IV MÉGANE 16v</p> <p>Ø bocas 27-90 mm r.o. 7701035317</p>	 <p><b>1607</b> l/rueda CLIO-II 1.2 y 1.9 (palier de Ø 38 mm) KANGOO con palier de Ø 38 mm</p> <p>Ø bocas 38-78 mm r.o.</p>
 <p><b>1733-E (elástico-cono)</b> <b>1733 (normal)</b> l/rueda TRAFIC-MASTER (trípode Ø 98 mm)</p> <p>Ø bocas 22-92 mm. Doble garganta r.o. 7701013275</p>	 <p><b>1629-E (elástico-cono)</b> l/rueda TRAFIC-MASTER (homocinética de Ø 102 mm)</p> <p>Ø bocas 22-96 mm. Liso r.o. 7701201810</p>
 <p><b>1051</b> l/rueda MEGANE-I2.0 (homocinética Ø 78 mm)</p> <p>Ø bocas 28-78 mm r.o. 7701469414</p>	
 <p><b>1272</b> l/cambio R 4 - R 5 - R 6 - R 6 - R 7</p> <p>Ø bocas 19-69 mm r.o. 7701013803</p>	 <p><b>339</b> l/cambio <b>transmisión izquierda</b> R 9/11-SUPER 5-EXPRESS-CLIO-19 R 21/25 GTS-TWINGO-MEGANE</p> <p>sin rodamiento r.o.</p>
 <p><b>1537</b> l/cambio <b>transm. izquierda</b> R 9/11-SUPER 5-EXPRESS-CLIO-19 R 21/25 GTS-TWINGO-MEGANE</p> <p>con rodamiento Ø 25,80 mm r.o. 7701462100</p>	 <p><b>1763</b> l/cambio <b>transm. izquierda</b> SUPER 5 - EXPRESS CLIO - R 19</p> <p>con rodamiento Ø 23,80 mm r.o. 7701464129</p>
 <p><b>1562</b> l/cambio <b>transm. izquierda</b> SUPER 5 - EXPRESS Diesel</p> <p>con rodamiento Ø 22,80 mm r.o. 7701463955</p>	 <p><b>2304</b> l/cambio <b>transm. izquierda</b> LAGUNA - SAFRANE MEGANE 16v</p> <p>Ø 114 mm con rodamiento Ø 28,00 mm r.o. 7701468573</p>
 <p><b>1367</b> l/cambio <b>transm. derecha</b> R 9/11 (gasolina y Diesel) - R 21 GTS SUPER 5 y EXPRESS (gasolina)</p> <p>Ø bocas 28-69 mm r.o. 7701462101</p>	 <p><b>1626</b> l/cambio <b>transm. derecha</b> SUPER 5 Diesel - EXPRESS Diesel R 19 - CLIO - TWINGO R-18 Diesel (palier de Ø 26 mm) MÉGANE todos mods. Ø bocas 20-69 mm r.o. 7701450617</p>

# KIT REPARACION TRANSMISION

## RENAULT



**1523**  
l/cambio  
R 21 TXE-D - R25 TXE-D  
R 18 GTX desde '84  
TRAFIC-MASTER-SAFRANE  
SPACE

Ø bocas 24-73 mm  
r.o. 7701465021



**1559**  
l/cambio **transm. derecha**  
CLIO-II 1.2  
KANGOO 1.2  
MEGANE-SCENIC desde '98  
TWINGO

Ø bocas 23-65 mm  
r.o.



**1135**  
l/cambio **transm. derecha**

TRAFIC-II  
LAGUNA-II  
MASTER '98-  
SPACE-IV  
Ø cárter 82 mm, largo 100 mm  
r.o. 7701462101



**1139**  
l/cambio **transm. derecha**

TRAFIC-II  
LAGUNA-II  
MASTER '98-SPACE-IV  
**Ø 105 mm**  
**con rodamiento Ø 28,00 mm**  
r.o. 7701450617



**1128**  
l/cambio  
TWINGO  
R 19  
CLIO-I

Ø bocas 20-80 mm  
r.o. 7701469389

















**1130**  
l/cambio  
MEGANE-II

Ø bocas 27 mm (trilobulado)  
r.o.

## KIT REPARACION TRANSMISION

### ROVER - SEAT (derivados FIAT)

 <p><b>1221</b> 1/rueda MINI - METRO</p> <p>Ø bocas 20-68 mm r.o. BAU 4445</p>	 <p><b>1342</b> 1/rueda ROVER216 AUSTIN MAESTRO MONTEGO 1.3 - 1.6 y 2.0</p> <p>Ø bocas 20-78 mm r.o. BAU 4441</p>
 <p><b>1633</b> 1/rueda ROVER213</p> <p>Ø bocas 23-73 mm</p>	 <p><b>1216</b> 1/rueda ROVER216-218-220</p> <p>Ø bocas 23-80 mm r.o.</p>
 <p><b>1626</b> 1/cambio ROVER216 AUSTIN MAESTRO 2.0 MONTEGO 2.0</p> <p>Ø bocas 20-69 mm r.o. BAU 4995</p>	
 <p><b>1170</b> 1/rueda 127 - PANDA - RITMO RONDA - FURA - TRANS</p> <p>Ø bocas 21-71 mm r.o. HB 14153700</p>	 <p><b>1514-E (elástico-cono)</b> <b>1514 (normal)</b> 1/rueda IBIZA hasta '93 MALAGA - MARBELLA</p> <p>Ø bocas 21-71 mm r.o. SE-127141537A</p>
 <p><b>1577</b> 1/rueda TERRA 1.3 Diesel TERRA 1.4 Diesel RONDA 1.6 CRONO</p> <p>Ø bocas 25-74 mm r.o.</p>	 <p><b>176</b> 1/cambio 127 - PANDA - TRANS RITMO</p> <p>retén de Ø 25 mm r.o. HB-141531</p>
 <p><b>313</b> 1/cambio FURA - RONDA (salvo Crono)</p> <p>retén de Ø 25 mm r.o. HH141531</p>	 <p><b>1636 con rodamiento Ø 25,8 mm</b> <b>349 sin rodamiento</b> 1/cambio IBIZA-MALAGA hasta '93 MARBELLA TERRA gasolina</p> <p>r.o.</p>
 <p><b>1632</b> 1/cambio TERRA Diesel</p> <p>Ø bocas 25-74 mm r.o. 171407282B</p> 	 <p><b>1054 con rodamiento Ø 25,8 mm</b> 1/cambio MARBELLA</p> <p>r.o.</p>

## KIT REPARACION TRANSMISION

### SUZUKI-TOYOTA



**1854**  
1/rueda  
SUZUKI VITARA

Ø bocas 21-69 mm. Altura 95 mm  
r.o. 44118-82012



**1959**  
1/rueda  
SUZUKI SWIFT

Ø bocas 21-73 mm. Altura 86 mm  
r.o. 44118-64B10-44118-64B20



**1052**  
1/rueda  
TOYOTA CARINAE

Ø bocas 22-77 mm  
r.o. 04438-10022



**2373**  
1/rueda  
TOYOTA CARINAE

Ø bocas 23-83 mm  
r.o. 04438-10022













## KIT REPARACION TRANSMISION

### SEAT (derivados VW) - SKODA - VOLKSWAGEN - AUDI

 <p><b>1359-E</b> (elástico-cono) <b>1359</b> (normal) l/rueda GOLF-1/POLO '84 a '95 PASSAT IBIZA 1.0-1.3-1.4-1.6-D hasta '94 TOLEDO 1.6-1.9D hasta '94</p> <p>Ø bocas <b>21-78 mm</b> r.o. 191498203C</p>	 <p><b>1575-E</b> (elástico-cono) <b>1575</b> (normal) l/rueda GOLF-2 1.6 y D IBIZA 1.8-2.0 hasta '94 TOLEDO 1.8-2.0-TD hasta '94</p> <p>Ø bocas 22-82 mm r.o. 191498203</p>
 <p><b>1689-E</b> (elástico-cono) <b>1689</b> (normal) l/rueda <b>transm. derecha</b> POLO '84 a '95</p> <p>Ø bocas <b>18-78 mm</b> r.o. 871498203A</p>	 <p><b>1642-E</b> (elástico-cono) <b>1642</b> (normal) l/rueda AUDI 80 1.8-2.0-Diesel AUDI 90 2.0-Diesel y TurboD VW PASSAT '88 a '96</p> <p>Ø bocas 22-84 mm r.o. 357498203A</p>
 <p><b>1638</b> l/rueda AUDI 100-200 hasta '94</p> <p>Ø bocas 24-92 mm r.o. 431407285C</p>	 <p><b>1187</b> l/rueda AUDI 80 2.3 AUDI 90 2.2-2.3-2.6 AUDI A4-A6 VW PASSAT '97 VW TRANSPORTER hasta '98</p> <p>Ø bocas <b>24-92 mm</b> r.o. 441407285</p>
 <p><b>1921</b> l/rueda</p> <p>AUDI A3 1.6 GOLF-3 1.4-1.6-1.9D GOLF-4 1.4-1.6(105cv)-1.9SDi SKODA OCTAVIA 1.4-1.6-1.9SDi VW CADDY / INCA 1.4-1.6-SDi VW POLO '95 salvo 1.6GTi - LUPO IBIZA 1.0-1.4-1.6-SDi desde '94 TOLEDO d/'94 hasta '99 salvo 16v TOLEDO '99/'04- 1.4-1.6-1.9SDi</p> <p>Ø bocas <b>26-77 mm</b> r.o. 1H0498203C</p>	 <p><b>1297</b> l/rueda</p> <p>AUDI A3 1.6-1.8-2.0TDi GOLF-3 1.8-2.0-TDi GOLF-4 1.6(100cv)-1.8-2.0-TDi/90-110 SKODA OCTAVIA 1.8-2.0-TDi VW CADDY / INCA TDi VW POLO '95 1.6 GTi VW PASSAT '97 IBIZA 1.8-2.0 y TDi desde '94 TOLEDO 2.0-16v TOLEDO '99 1.8-2.0-TDi (90/100-110) TOLEDO '04- 1.8-2.0-TDi (90/100-110)</p> <p>Ø bocas <b>25-86 mm</b> r.o. 1H0498203A</p>
 <p><b>1102</b> l/rueda GOLF 4 TDi de 130-150cv AUDI A3 TDi de 130cv-150cv IBIZA '99 TDi de 115-130-150cv TOLEDO '99 TDi de 115-130-150cv TOLEDO '04- TDi de 115-130-150cv</p> <p>Ø bocas 29-98 mm r.o. 1J0498203A</p>	 <p><b>1225</b> l/rueda VW SHARAN TRANSPORTER desde '98 SEAT ALHAMBRA</p> <p>Ø bocas 29-98 mm r.o.</p>
 <p><b>1732-E</b> l/rueda</p> <p>VW PASSAT '97 AUDI A4-A6</p> <p>Ø bocas 22-81 mm. Una garganta r.o.</p>	

## KIT REPARACION TRANSMISION

### SEAT (derivados VW) - SKODA - VOLKSWAGEN - AUDI

 <p><b>1632</b> l/cambio SEAT AROSA VW LUPO VW POLO '95 - CADDY hasta '94 IBIZA 1.0-1.3-1.4 hasta '94 VW GOLF 1/2/3 1.3-1.4-1.6 hasta '96 Ø bocas <b>24-89 mm</b> r.o. 171498201A</p>	 <p><b>1851</b> l/cambio <b>transm. derecha</b> VW POLO hasta '94  Ø bocas <b>18-89 mm</b> r.o.</p>
 <p><b>1455</b> l/rueda AUDI 80-90 TOLEDO 1.6-1.9D VW GOLF 2 1.6-1.8-2.0-1.6D-TD VW GOLF 3 1.4-1.6 desde '96  Ø bocas <b>24-94 mm</b> r.o. 191498201D</p>	 <p><b>1529</b> l/rueda VW PASSAT hasta '88 AUDI 90-100 hasta '91  Ø bocas <b>24-100 mm</b> r.o.</p>
 <p><b>1560</b> l/cambio <b>transm. izquierda</b> AUDI A3 1.8-2.0-1.9TDi AUDI A4-A6 SKODA OCTAVIA 1.8-2.0-1.9TDi IBIZA 1.8-2.0-TD hasta '94 TOLEDO 1.8-2.0-TD-TDi VW GOLF 2 1.8-2.0-TD VW GOLF 3 1.8-2.0-TDi VW GOLF 4 1.8-2.0-1.6(100cv)-1.9TDi VW PASSAT '88 a '96  Ø bocas <b>24-100 mm</b> r.o. 191498201B</p>	 <p><b>1637</b> l/cambio <b>transm. derecha</b> AUDI A3 1.8-2.0-1.9TDi AUDI A4-A6 SKODA OCTAVIA 1.8-2.0-1.9TDi IBIZA 1.8-2.0-TD hasta '94 TOLEDO 1.8-2.0-TD-TDi VW GOLF 2 1.8-2.0-TD VW GOLF 3 1.8-2.0-TDi VW GOLF 4 1.8-2.0-1.6(100cv)-1.9TDi VW PASSAT '88 a '96  Ø bocas <b>24-100 mm</b> r.o. 191498202A</p>
 <p><b>2308</b> l/cambio AUDI A4-A6 VW PASSAT '97 GOLF-4/5, 6 marchas TRANSPORTER T4  Ø bocas <b>22-107 mm</b> r.o. 443407283A</p>	 <p><b>1192</b> l/cambio AUDI A3 1.8-2.0-1.9TDi SKODA OCTAVIA 1.8-2.0-1.9TDi IBIZA desde '94 - INCA - CADDY TOLEDO '99 1.9TDi-1.8-2.0 VW GOLF 4 1.8-2.0-1.6(100cv)-1.9TDi  Ø bocas <b>27-100 mm</b> r.o.</p>
 <p><b>1106</b> l/cambio AUDI A3 1.6 IBIZA desde '94 TOLEDO desde '96 VW GOLF 4 1.4-1.6-1.9SDi  Ø bocas <b>27-94 mm</b> r.o.</p>	 <p><b>1061</b> l/cambio VW POLO '95  Ø bocas <b>27-89 mm</b> r.o. 6N0498201</p>
 <p><b>1069</b> l/cambio VW TRANSPORTER VW SHARAN SEAT ALHAMBRA  Ø bocas <b>24-57 mm</b> r.o.</p>	

## UNIVERSALES

### 1635

**UNIVERSAL** turismos  
para montar con cono o útil neumático

abrazaderas de ACERO INOXIDABLE  
(flexibles) tipo oreja de longitud variable  
Ø pequeña: de 21 a 45 mm  
Ø grande: de 65 a 110 mm



### 1063

**UNIVERSAL** furgonetas y 4x4  
para montar con cono o útil neumático

abrazaderas de ACERO INOXIDABLE  
(flexibles) tipo oreja de longitud variable  
Ø pequeña: de 21 a 45 mm  
Ø grande: de 65 a 110 mm



### 1285

**UNIVERSAL MICROCOCHES**  
AYXAM - LIGIER - etc.

abrazaderas de ACERO INOXIDABLE  
(flexibles) tipo oreja de longitud variable  
Ø boca pequeña: 16 mm  
Ø boca grande: 58 mm



## RODAMIENTOS PARA FUELLE TRANSMISION



**4517** Ø 23,00 mm

Alfa Romeo - Fiat - Lancia

**4516** Ø 23,80 mm

Renault

**4519** Ø 24,50 mm

Fiat

**4515** Ø 25,80 mm

PSA - Renault - Seat

**4518** Ø 28,00 mm

Renault



## KIT REPARACION TRANSMISION

### ALFA ROMEO

	RUEDA	CAMBIO
ALFA 33 1.3	1359E	1510
ALFA 33 1.5 - 1.7 y 4x4 (hasta '90)	n/d	1510
ALFA 33 1.5-1.7 (desde '90)	1618	1510
ALFA 75 (palier trasero)	1510	1510
ALFA 145-146 1.4-1.6-1.8-D hasta '97	1996	1611
ALFA 145-146 2.0 hasta '97	1217	1611
ALFA 145-146 1.4 desde '97	1996	1120 (con rodamiento Ø 24.5 mm)
ALFA 145-146 1.6-1.8-2.0 y JTD desde '97	1115	1611
ALFA 147 1.6-2.0	1115	1611
ALFA 147 1.9JTD	1217	1611
ALFA 155 TwinSpark (junta de Ø 85 mm)	1575E	1611
ALFA 155 TwinSpark (junta de Ø 80 mm)	1996	1611
ALFA 155 2.5TD	1217	n/d
ALFA 156 1.6-1.8-2.0-1.9JTD	1115	1611
ALFA 156 2.4JTD-V6	1217	1510
ALFA 164-2.0	1575E	2308
ALFA 164-2.5-3.0V6-2.5TD	1614	1510

### AUDI

80 1.8-2.0-Diesel-TurboD	1642E	1455
80 2.3	1187	1560 (Izqd.) - 1637 (Dcha.)
90 2.0-Diesel-TurboD	1642E	1455
90 2.2-2.3-2.6	1187	1560 (Izqd.) - 1637 (Dcha.)
100 - 200	1638	1560 (Izqd.) - 1637 (Dcha.)
A3 1.6	1921	1106
A3 1.8-2.0-TDi(110cv)	1297	1560 (Izqd.) - 1637 (Dcha.) / neopreno
	1297	1192 termoplástico
A3 TDi 130-150cv	1102	1560 (Izqd.) - 1637 (Dcha.) / neopreno
	1102	1192 termoplástico
A4 (piña de Ø 92 mm)	1187	2308
A4 (piña de Ø 81 mm)	1732	2308
A6 (piña de Ø 92 mm)	1187	2308
A4 (piña de Ø 81 mm)	1732	2308

### B M W

series 3 y 5 (palier trasero Ø 24 mm)	1510	1510
series 3 y 5 (palier trasero Ø 30 mm)	1150	1150

### CITROËN

2 CV - DYANE - MEHARI (transm. de cruceta)	1569	1570 - 1571
2 CV - DYANE - MEHARI (transm. de bolas)	1363	1571
AX 1.0-1.1-1.4 hasta '94	1532E	1533
AX 1.0-1.1-1.4 desde '94	1521	1533
AX 1.6 GTi hasta '90	1532E	1533
AX 1.6 GTi desde '90 hasta '94	1710E	1533
AX 1.6 GTi desde '94	1521	1533
AX 1.4 Diesel	1532E	1533
AX 1.5 Diesel	1521	1533
BERLINGO 1.1-1.4 sin ABS hasta '98	1521	1533
BERLINGO 1.1-1.4 con ABS hasta '98	1432	1533
BERLINGO 1.1-1.4 desde '98	1427	1428
BERLINGO 1.8-1.9D-TD-HDi	1222	1213
BX-14	1340E	1556
BX-16-19 hasta '87	1340E	1362
BX-16-19 desde '87 y 1.9Diesel	1493E	1362
BX-16-19 GTi y 1.9TurboD desde '90	1708E	1362
C15 gasolina hasta '89	1488E	1556
C15 gasolina desde '89 hasta '93	1761E	1533
	(una garganta)	
	(doble garganta)	
	1273E	1533
C15 gasolina desde '93 hasta '95	1710E	1533
C15 gasolina desde '95 hasta '04	1521	1533
C15 D (Diesel) hasta '89	1493E	1362
C15 D (Diesel) desde '89 hasta '93	1493E	1626
C15 D (Diesel) desde '93 hasta '95	1710E	1839

## KIT REPARACION TRANSMISION

### CITROËN

	RUEDA	CAMBIO
C15 D (Diesel) desde '95 hasta '04	1521	1839 - 1533 (según transmisión)
C15 TU + D todos tipos desde '04	1427	1428
C25 furgoneta	1579	1580
C2-C3 hasta -12/'02	1427	1428 (Dcha.) - 1142 (izqda.)
C2-C3 desde 12/'02- transm. derecha	1109	1428
C2-C3 desde 12/'02- transm. izquierda	1433	1142
C4	1113	1110
C5 1.8-2.0-2.0HDI(90cv)-2.2HDI	1113	1213
C5 2.0HDI(110cv)-2.2HDI	1460	1122
GS - GSA	1363	n/d
JUMPER 1.000-1.400 Kgs.	1225	1362
JUMPER 1.800 Kgs. hasta '96	2307	1407
JUMPER 1.800 Kgs. desde '96	1391	1407
JUMPY - EVASION 1.6-1.8 (cambio BE3)	1996	1362
JUMPY - EVASION 1.6-1.8 (cambio BE3R)	1520	1362
JUMPY - EVASION 1.9D	1222	1213
JUMPY - EVASION 1.9TurboD	1217	1362
JUMPY - EVASION 2.0HDI	1499	1362
SAXO 1.0-1.1 transm. derecha	1218	1606
SAXO 1.4-1.5D transm. derecha	1434	1533
SAXO 1.1-1.4-1.5D transm. izquierda	1433	1533
SAXO 1.6 transmisión derecha	1521	1533
SAXO 1.6 transmisión izquierda	1521	1537 (con rodamiento Ø 25.8 mm)
VISA 652 cc	1273E	1572
VISA 1118 - 1219 cc	1273E	1556
VISA 1124 - 1360 cc	1488E	1556
VISA 1580 GTI y 1.7 Diesel	1493E	1362
XANTIA 1.6-1.8 hasta '97	1493E	1839
XANTIA 1.9D-1.9TD hasta '97	1708E	1839
XANTIA 1.6-1.8-1.9D-1.9TD desde '97 transm. izquierda	2305	1839
XANTIA 1.6-1.8-1.9D-1.9TD desde '97 transm. derecha	1222	1213
XANTIA 2.0-2.0HDI-2.1TD transm. izquierda	1225	1741
XANTIA 2.0-2.0HDI-2.1TD transm. derecha	1460	1467
XM - 2.2 Diesel	1708E	1839
XM - 3.0V6-TurboD y automáticos hasta '93	1943	1362
XM - todos desde '93	2305	1839
XSARA 1.4-1.6 (salvo PICASSO) hasta '98	1521	1533
XSARA 1.4-1.6 (salvo PICASSO) desde '98	1427	1428
XSARA PICASSO 1.4-1.6	1222	1213
XSARA y PICASSO 1.8-2.0-1.9D(hasta '99)-1.9TD-2.0HDI	1222	1213
XSARA y PICASSO 1.9D desde '99 (motor DW8)	1460	1213
ZX 1.4	1710E	1533
ZX 1.6-1.9(sin ABS) y Diesel hasta '93	1493E	1362
ZX 1.6-1.8 (sin ABS) y Diesel desde '94	2305	1839
ZX 1.6(ABS)-1.8(ABS)-2.0 y Diesel hasta '93	1708E	1362
ZX 1.6-1.8-2.0-Diesel y TurboD desde '94	1222	1213

### FIAT

BRAVO-BRAVA 1.4-1.6-1.9D-1.9JTD hasta '96	1996	1583 (con rodamiento Ø 23.0 mm)
BRAVO-BRAVA 1.8 hasta '96	1996	1611
BRAVO-BRAVA 1.4-1.6 desde '96	1996	1120 (con rodamiento Ø 24.5 mm)
BRAVO-BRAVA 1.9D-1.9JTD desde '96	1996	1611
BRAVO-BRAVA 2.0	1115	1611
CINQUECENTO 900cc	1578	1583 (Izqd.) - 1599 (Dcha.)
CINQUECENTO 1100cc	1578	1079
CROMA - hasta 10/'86	1613	1611
CROMA - desde 10/'86	1614	1611
DOBLO		
DUCATO hasta '94	1579	1580
DUCATO 1.000-1.400 Kgs. desde '94	1225	1362
DUCATO 1.800 Kgs. desde '94 hasta '97	2307	1407
DUCATO 1.800 Kgs. desde '97	1391	1407
FIORINO - todos mods.	1514E	1622 (Izqd.) - 1526 (Dcha.)
MAREA 1.4	1996	1079
MAREA 1.6	1996	1120 (con rodamiento Ø 24.5 mm)
MAREA 1.8-2.0-1.9D-JTD	1115	1611
MAREA 2.4JTD	1217	1611

## KIT REPARACION TRANSMISION

### FIAT

	RUEDA	CAMBIO
MAREA 2.0	1115	1611
MULTIPLA 1.6	1996	1120 (con rodamiento Ø 24.5 mm)
MULTIPLA 1.9JTD	1115	1611
PALIO 1.2	1618	1583 (con rodamiento Ø 23.0 mm)
PALIO 1.6-1.7TD	1996	1120 (con rodamiento Ø 24.5 mm)
REGATA - 70 - 70 S - 85 y 1.7 Diesel de 11/'84 a 2/'86	1514E	1568 (Izqd.) - 1526 (Dcha.)
REGATA - 70 - 70 S - 85 y 1.7 Diesel de 2/'86 a 10/'87	1514E	1622 (Izqd.) - 1526 (Dcha.)
REGATA - 70 - 70 S - 85 y 1.7 Diesel desde 10/'87	1578	1583 (Izqd.) - 1599 (Dcha.)
REGATA - 100 - 100 S y 1.9 TurboDiesel	1581	1611
SCUDO-ULYSSE 1.6-1.8 (cambio BE3)	1996	1362
SCUDO-ULYSSE 1.6-1.8 (cambio BE3R)	1520	1362
SCUDO-ULYSSE 1.9D	1222	1213
SCUDO-ULYSSE 1.9TurboD	1217	1362
SCUDO-ULYSSE 2.0HDi	1499	1362
SEICENTO	1578	1583 (Izqd.) - 1599 (Dcha.)
TIPO - 1.4 - 1.6	1618	1583
TIPO - 1.7 Diesel	1577	1583
TIPO - 1.9 TurboDiesel sin ABS	1619	1583
TIPO - 1.9 TurboDiesel con ABS	1614	1583
TEMPRA 1370-1580	1618	1583
TEMPRA 1750	1619	1583
TEMPRA 1.7D-1.9 Diesel	1577	1583
PANDA 30-45	1514E	n/d
PANDA 750-1000	1578	1583 (Izqd.) - 1599 (Dcha.)
PUNTO-I55-60-75-85-90	1996	1079
PUNTO-I1.4GT-1.7TD hasta 5/'96	1996	1611
PUNTO-I1.4GT desde 5/'96	1115	1611
PUNTO-I1.7TD desde 5/'96	1115	1120 (con rodamiento Ø 24.5 mm)
PUNTO-II1.2	1618	1079
PUNTO-II1.9D	1618	1120 (con rodamiento Ø 24.5 mm)
PUNTO-II1.8-1.9JTD	1614	1611
UNO - todos salvo i.e. de 11/'84 a 2/'86	1514E	1568
UNO - todos salvo i.e. de 2/'86 a 10/'87	1514E	1622
UNO - todos salvo i.e. desde 10/'87	1514E	1583 (Izqd.) - 1599 (Dcha.)
UNO - Turbo i.e. hasta 11/'85	1581	1611
UNO - Turbo i.e. de 11/'85 hasta 3/'88	1577	1611
UNO - Turbo i.e. desde 3/'88	1578	1611

### FORD

CONNECT	1298	1053
ESCORT - 1.1	1623E	1341
ESCORT - 1.3-1.4-1.6-XR3-1.8 EFI (salvo 16v)	1342E	1342
ESCORT - 1.8/16v - 2.0 OHC - RS Turbo	2451	1342
ESCORT - 1.8Diesel hasta '91	1342E	1341
ESCORT - Diesel y TurboD desde '91 hasta '95	2451	1342
ESCORT - Diesel y TurboD desde '95	2451	1227
FIESTA - 950-1100	1623E	1341
FIESTA - 1300-1400-1600- XR2 hasta '95	1342E	1342
FIESTA - 1.6 y 1.8 Diesel hasta '92	1342E	1341
FIESTA - 1.8 Diesel desde '92	1342E	1227
FIESTA '96 hasta '97	1075	1186
FIESTA desde '97	1075	1079
FIESTA '02- FUSION 1.3-1.4(gasolina)-1.6	1298	1145
FIESTA '02- FUSION 1.3-1.4(gasolina)-1.6	1373	1049
FIESTA '02- FUSION 1.4 TdCi	2378	1142
FOCUS	1298	1049
GALAXY	1225	1069
KA	1373	1079
MAVERICK	1184	n/d
MONDEO (homocinética de Ø 80 mm)	1993	n/d
MONDEO (homocinética de Ø 87 mm)	1994	n/d
ORION - 1.3-1.4-1.6 gasolina hasta '91	1342E	1342
ORION - Diesel hasta '91	1342E	1341
ORION - 16v-Diesel y TurboD desde '91	2451	1227
PROBE	1284	n/d
SIERRA (palier trasero)	1624	1624
TRANSIT '00-	1520	1227

n/d = no disponible

## KIT REPARACION TRANSMISION

HONDA	RUEDA	CAMBIO
CIVIC - CONCERTO	2373	n/d
ACCORD	1284	n/d
<b>HYUNDAI</b>		
EXCEL - PONY - COUPE - LANTRA (junta de Ø 84 mm)	1216	n/d
EXCEL - PONY - COUPE - LANTRA (junta de Ø 76 mm)	1959	n/d
<b>ISUZU</b>		
TROOPER	1198	n/d
<b>JEEP</b>		
GRANDCHEROKEE	2374	n/d
<b>LADA</b>		
NIVA	1852	1613
SAMARA	1359E	1359
<b>LANCIA</b>		
DELTA - 1.3 - 1.5 hasta 2/'86	1514E	1568 (Izqd.) - 1526 (Dcha.)
DELTA - 1.3 - 1.5 de 2/'86 hasta 10/'87	1514E	1622 (Izqd.) - 1526 (Dcha.)
DELTA - 1.3 - 1.5 de 10/'87 hasta 6/'88	1514E	1583 (Izqd.) - 1599 (Dcha.)
DELTA - 1.3 - 1.5 desde 10/'87	1578	1583 (Izqd.) - 1599 (Dcha.)
DELTA - TurboDiesel hasta 11/'86	1581	1611
DELTA - TurboDiesel desde 11/'86	1577	1611
DELTA - HF i.e.	1614	1611
DELTA - 1.6 i.e.	1619	1611
KAPPA 2.0	1115	1611
KAPPA 2.4TD	1614	1069
LYBRA 1.6	1996	1120 (con rodamiento Ø 24.5 mm)
LYBRA 1.8-2.0	1115	1611
LYBRA 1.9JTD	1217	1069
LYBRA 2.4JTD	1614	n/d
PRISMA - 1.3 - 1.5 hasta 10/'87	1514	1622 (Izqd.) - 1526 (Dcha.)
PRISMA - 1.3 - 1.5 desde 10/'87	1578	1583 (Izqd.) - 1599 (Dcha.)
PRISMA - Diesel y TurboDiesel	1577	1583 (Izqd.) - 1599 (Dcha.)
DEDRA - THEMA - 1.6	1618	1583
DEDRA - THEMA - 1.8 y TurboDiesel	1619	1611
DEDRA - THEMA - 2.0	1614	1611
Y10 hasta '92	1578	1583 (Izqd.) - 1599 (Dcha.)
Y10 desde '92	1996	1079
ZETA 2.0JTD	1499	1362
<b>MAZDA</b>		
323 1.6	1964	n/d
323 1.8	1493	n/d
<b>MERCEDES BENZ</b>		
turismos: palier trasero con fuelle Ø 22-57 mm	1066	1066
turismos: palier trasero con fuelle Ø 22-65 mm	1783	1783
turismos: palier trasero con fuelle Ø 28-57 mm	1149	1149
Clase A	1134	n/d
furgonetas MB100 / MB120 / MB140	1483E	1482
VITO-SPRINTER (junta de Ø 95mm)	1187	1794
VITO-SPRINTER (junta de Ø 100mm)	1750	1794

n/d = no disponible

## KIT REPARACION TRANSMISION

MITSUBISHI	RUEDA	CAMBIO
MONTERO-PAJERO	1961	n/d
<b>NISSAN</b>		
ALMERA 1.4	1181	n/d
ALMERA 1.6 y Diesel	1818	n/d
BLUEBIRD	1342E	n/d
MICRA 1.0	2378	n/d
MICRA 1.3	1181	n/d
PRIMERA 1.6	1181	n/d
PRIMERA 2.0	1818	n/d
SUNNY 1.6-2.0	1960	n/d
TERRANO-II	1184	n/d
<b>OPEL</b>		
ASCONA 1.6 gasolina	1359E	1490
ASCONA 1.6 Diesel-1.8-2.0	1575E	1730
ASTRA-F 1.4	1770E	1490
ASTRA-F 1.6-1.8-2.0-Diesel y GSI	1575E	1730
ASTRA-G 1.2	1112	1490
ASTRA-G 1.4-1.6	1989	1490
ASTRA-G 1.8-2.0-2.0DTL	1175	1114
ASTRA-G 1.7DTL	1175	1490
CALIBRA todos modelos	1575E	1730
CORSA 1.0 - 1.2 - 1.3 - 1.4	1343E	1344
CORSA 1.6 GSI (hasta '93) y Diesel (hasta '93)	1343E	1490
CORSA B	1989	1344
CORSA C gasolina	1112	1148
CORSA C 1.7diesel	1921	1147 - 1344 (alternativamente)
FRONTERA	1198	n/d
KADETT 1.3 y 1.6 gasolina (motor SV)	1359E	1490
KADETT 1.4	1770E	1490
KADETT 1.6 gasolina (motor SH)	1575E	1730
KADETT 1.6 Diesel - 1.7 Diesel - 1.8 - 2.0 y GSI	1575E	1730
MONTERREY	1198	n/d
VECTRA-A todos modelos	1575E	1730
VECTRA-B 1.6	1989	1490
VECTRA-B 1.8-2.0-1.7DTL-2.0TD	1175	1114
ZAFIRA 1.4-1.6	1989	1490
ZAFIRA 1.7DTL	1175	1490
ZAFIRA 1.8-2.0-2.0DTL	1175	1114
<b>PEUGEOT</b>		
106 - 1.0-1.1 hasta '96	1532E	1606
106 - 1.4 (salvo SXI)-1.4 Diesel	1532E	1533
106 - 1.4 SXI hasta '96	1710E	1533
106 - 1.0-1.1 transm. derecha desde '96	1218	1606
106 - 1.4-1.5D transm. derecha desde '96	1434	1533
106 - 1.1-1.4-1.5D transm. izquierda desde '96	1433	1533
106 - 1.6 transmisión derecha desde '96	1521	1533
106 - 1.6 transmisión izquierda desde '96	1521	1537 (con rodamiento Ø 25.8 mm)
205 - todos hasta 10/'85	1273E	1362
205 - todos desde 10/'85 hasta 12/'86	1273E	1626
205 - 1.6 y Diesel desde '87 hasta '95	1710E	1626
205 - 1.3 Rallye (TU24)	1710E	1626
205 - 1.1-1.4 desde '89 hasta '95	1710E	1533
205 - 1.1-1.4 desde '95	1710E	1533
205 - Diesel desde '95	1521	1626
205 - Automatico (motor XU de 1580 cc)	1493E	1362
205 - 1.9 GTI y TurboDiesel	1708E	1362
206 - 1.1-1.4(gasolina)-1.6 hasta -12/'02	1427	1428
206 - 1.1-1.4(gasolina)-1.6 desde 12/'02-	1109	1428
206 - 1.9D-1.4HDi-2.0HDi-2.0(gasolina) hasta -2/'01	1222	1213
206 - 1.9D-1.4HDi-2.0HDi-2.0(gasolina) desde 2/'01-	1113	1213
306 - 1.4-1.6 sin ABS hasta '98	1521	1533

n/d = no disponible

## KIT REPARACION TRANSMISION

### PEUGEOT

	RUEDA	CAMBIO
306 - 1.4-1.6 con ABS hasta '98	1432	1533
306 - 1.4-1.6 sin ABS desde '98	1427	1428
306 - 1.8-2.0-1.9D-1.9TD-2.0HDi	1222	1213
307 - 1.4 gasolina	1427	1428
307 - 1.4HDi-2.0HDi(hasta 2/'01)-1.6-2.0(hasta 2/'01)	1222	1213
307 - 2.0HDi (desde 2/'01)-2.0/16vHDi-2.0 (desde 2/'01)	1113	1110
309 - 1294 - 1442 - 1592 cc y Diesel hasta 12/'86	1273E	1626
309 - 1294 - 1442 - 1592 cc y Diesel desde 12/'86	1710E	1626
309 - Automatico	1710E	1362
309 - 1.9 GTI y TurboDiesel	1708E	1362
405 - 1.6-1.9 carburador y 1.9 Diesel hasta '93	1493E	1626
405 - 1.9-2.0 inyección - Mi-16 y TurboD hasta '93	1708E	1362
405 - 1.8-2.0-1.9D-1.9TD desde '93	2305	1839
406 - 1.6-1.8-1.9D-1.9TD	1222	1213
406 - 2.0-2.1TD-2.0HDi	1460	1467
407 - 1.8-2.0-1.6HDi	1113	1213
407 - 2.0HDi - 2.2HDi	1460	1110
605 - 2.0 gasolina	1708E	1362
605 - 3.0 V6 gasolina y TurboD hasta '93	1943	1362
605 - todos desde '93	2305	1839
BOXER 1.000-1.400 Kgs.	1225	1362
BOXER 1.800 Kgs. hasta '96	2307	1407
BOXER 1.800 Kgs. desde '96	1391	1407
EXPERT-806 1.6-1.8 (cambio BE3)	1996	1362
EXPERT-806 1.6-1.8 (cambio BE3R)	1520	1362
EXPERT-806 1.9D	1222	1213
EXPERT-806 1.9TurboD	1217	1362
EXPERT-806 2.0HDi	1499	1362
J5 - furgoneta	1579	1580
PARTNER 1.1-1.4 sin ABS hasta '98	1521	1533
PARTNER 1.1-1.4 con ABS hasta '98	1432	1533
PARTNER 1.1-1.4 desde '98	1427	1428
PARTNER 1.8-1.9D-TD-HDi	1222	1213

### RENAULT

R 4 - R 5 - R 6 - R 7	1221E	1272
R 9 - R 11 gasolina salvo Turbo	1274E	1537 (Izqd.) - 1367 (Dcha.)
R 9 - R 11 Diesel (palier de Ø 35 mm)	1274E	1537 (Izqd.) - 1367 (Dcha.)
R 9 - R 11 Diesel (palier de Ø 40 mm)	1628	1537 (Izqd.) - 1367 (Dcha.)
R 12	1273E	1272
R 14	1273	1556
R 18 GTS - GTL - FUEGO	1274E	1315
R 18 Diesel (palier de Ø 40 mm)	1628	1315
R 18 Diesel (palier de Ø 26 mm)	1273E	1523
R 18 GTX desde '84	1343	1523
R 19 1.4 GTS	1696	1537 (Izqd.) - 1626 (Dcha.)
R 19 1.4 TS-GTS-TSE	1517	1537 (Izqd. Ø25.8) - 1626 (Dcha.)
R 19 1.7 GTX-TXE - 1.8 TXI - 16v.	1517	1537 (Izqd. Ø25.8) - 1626 (Dcha.)
R 19 Diesel, transmisión derecha	1555	1626
R 19 Diesel, transmisión izquierda	1517	1537 (Ø25.8) - 1763 (Ø23.8)
R 21 GTS transmisión derecha hasta '92	1557E	1367
R 21 GTS transmisión izquierda hasta '92	1274E	1537
R 21 GTS desde '92	1555	1537 (Izqd.) - 1367 (Dcha.)
R 21 TXE y Diesel con transmisión Ayra o Gkn hasta '92	1575	1523
R 21 TXE y Diesel con transmisión Löbro hasta '92 * E	1732	1523
R 21 TXE y D homocinética de Ø 85 mm desde '92	1517	1523
R 21 TXE y D homocinética de Ø 82 mm desde '92	1432	1523
R 25 - TS - GTS	1274E	1537 (Izqd.) - 1367 (Dcha.)
R 25 - TX - GTX - D hasta '90	1693	1523
R-25 - TX - GTX - D desde '90	1520	1523
CLIO-I 1.1	1696E	1537 (Izqd.) - 1626 (Dcha.)
CLIO-I 1.2/1.4 (trípode de Ø 70 mm)	1431	1537 (Izqd. Ø 25.8) - 1626 (Dcha.)
	1431	1763 (Izqd. Ø 23.8) - 1626 (Dcha.)
CLIO-I 1.2/1.4 (trípode de Ø 82 mm)	1432	1537 (Izqd. Ø 25.8) - 1626 (Dcha.)
	1432	1763 (Izqd. Ø 23.8) - 1626 (Dcha.)

n/d = no disponible



## KIT REPARACION TRANSMISION

### RENAULT

	RUEDA	CAMBIO
CLIO-I 1.7/1.8/16v.	1732E	1537 (Izqd.) - 1626 (Dcha.)
CLIO-I Diesel	1555	1537 (Izqd. Ø 25.8) - 1626 (Dcha.)
	1555	1763 (Izqd. Ø 23.8) - 1626 (Dcha.)
CLIO-II 1.2 hasta 6/'99	1432	1537 (Izqd. Ø 25.8) - 1559 (Dcha.)
CLIO-II 1.4 hasta 6/'99	1432	1537 (Izqd. Ø 25.8) - 1523 (Dcha.)
CLIO-II 1.9D-DTi hasta 6/'99	1432	1537 (Izqd. Ø 25.8) - 1533 (Dcha.)
CLIO-II 1.2-1.4-1.5DCi-1.9D-DTi desde 6/'99	1432	2304 (Izqd. Ø 28.0) - 1559 (Dcha.)
ESPACE-II	1343	1523
ESPACE-III	1517	2304 (Izqd. Ø 25.8) - 1523 (Dcha.)
ESPACE-IV	1517	2304/1139 (Izqd. Ø 28.0) - 1135 (Dcha.)
EXPRESS gasolina 5 v (transmisión derecha) hasta '92	1557E	1367
EXPRESS gasolina 5 v (transmisión izquierda) hasta '92	1274E	1537
EXPRESS gasolina, cambio de 4 velocidades, hasta '92	1696E	1763 (Izqd. Ø 23.8) - 1626 (Dcha.)
EXPRESS Diesel, hasta '92	1273E	1537 (Izqd. Ø 25.8) - 1626 (Dcha.)
	1273E	1763 (Izqd. Ø 23.8) - 1626 (Dcha.)
	1273E	1562 (Izqd. Ø 22.8) - 1626 (Dcha.)
EXPRESS todas desde modelo '92	1517	1537 (Izqd. Ø 25.8) - 1626 (Dcha.)
KANGOO 1.2 hasta 6/'99	1432	1537 (Izqd. Ø 25.8) - 1559 (Dcha.)
KANGOO 1.4 hasta 6/'99	1432	1537 (Izqd. Ø 25.8) - 1523 (Dcha.)
KANGOO 1.9D-1.9DTi hasta 6/'99	1432	1537 (Izqd. Ø 25.8) - 1533 (Dcha.)
KANGOO 1.2-1.4-1.9D-1.9DTi desde 6/'99, palier de Ø 31 mm	1432	2304 (Izqd. Ø 28.0) - 1559 (Dcha.)
KANGOO 1.2-1.4-1.9D-1.9DTi desde 6/'99, palier de Ø 38 mm	1607	2304 (Izqd. Ø 28.0) - 1559 (Dcha.)
KANGOO 1.5DCi, palier de Ø 31 mm	1432	2304 (Izqd. Ø 28.0) - 1559 (Dcha.)
KANGOO 1.5DCi, palier de Ø 38 mm	1607	2304 (Izqd. Ø 28.0) - 1559 (Dcha.)
LAGUNA, junta homocinética de Ø 85 mm	1432	2304 (Izqd.) - 1135 (Dcha.)
LAGUNA, junta homocinética de Ø 90 mm	1517	2304/1139 (Izqd. Ø 28.0) - 1135 (Dcha.)
MASTER, trípode de 98 mm, hasta '93	1733E	1523
MASTER, homocinética de 102 mm, hasta '93	1629E	1523
MASTER, desde '93	1520	1523
MASTER, desde '98 (piña de Ø 90 mm)	1520	1139/2304 (Izqd. Ø 28.0) - 1135 (Dcha.)
MASTER, desde '98 (piña de Ø 98 mm)	1225	1139/2304 (Izqd. Ø 28.0) - 1135 (Dcha.)
MÉGANE-SCENIC 1.4-1.6-1.9Diesel hasta '98	1555	1537 (Izqd.) - 1626 (Dcha.)
MÉGANE-SCENIC 1.4-1.6-1.9DTi-DCi desde '98	1555	2304 (Izqd.) - 1559 (Dcha.)
MÉGANE-SCENIC 2.0 hasta '98	1432	1537 (Izqd.) - 1626 (Dcha.)
MÉGANE-SCENIC 2.0 desde '98 (piña de Ø 82 mm)	1432	2304 (Izqd.) - 1559 (Dcha.)
MÉGANE-SCENIC 2.0 desde '98 (piña de Ø 78 mm)	1051	2304 (Izqd.) - 1559 (Dcha.)
MÉGANE-SCENIC 16v	1520	2304 (Izqd.) - 1626 (Dcha.)
MÉGANE-II	1432	1130
SAFRANE	1432	2304 (Izqd.) - 1523 (Dcha.)
SUPER 5 gasolina (transmisión derecha) salvo Turbo	1557E	1367
SUPER 5 gasolina (transmisión izquierda) salvo Turbo	1274E	1537
SUPER 5 gasolina 1.1	1696E	1537 (Izqd. Ø 25.8) - 1626 (Dcha.)
	1696E	1763 (Izqd. Ø 23.8) - 1626 (Dcha.)
	1696E	1562 (Izqd. Ø 22.8) - 1626 (Dcha.)
SUPER 5 Turbo hasta '88	n/d	1537 (Izqd. Ø 25.8) - 1523 (Dcha.)
SUPER 5 Turbo desde '88	1555	1537 (Izqd. Ø 25.8) - 1523 (Dcha.)
SUPER 5 Diesel	1273E	1537 (Izqd. Ø 25.8) - 1626 (Dcha.)
	1273E	1763 (Izqd. Ø 23.8) - 1626 (Dcha.)
	1273E	1562 (Izqd. Ø 22.8) - 1626 (Dcha.)
TRAFIC trípode de 98 mm, hasta '92	1733E	1523
TRAFIC homocinética de 102 mm, hasta '92	1629E	1523
TRAFIC desde '92	1520	1523
TRAFIC-II	1520	1139/2304 (Izqd. Ø 28.0) - 1135 (Dcha.)
	1520	2304 (Izqd. Ø 28.0) - 1135 (Dcha.)
TWINGO	1432	1537 (Izqd.) - 1559 (Dcha.)
	1432	1128

### ROVER - AUSTIN

MINIMETRO	1221E	n/d
AUSTIN MAESTRO - MONTEGO 1.3 - 1.6	1342E	1341
AUSTIN MAESTRO - MONTEGO 2.0	1342E	1626
ROVER 213	1633	n/d
ROVER 216 hasta '92	1342E	1626
ROVER desde '92 216-218-220D	1216	n/d

n/d = no disponible

## KIT REPARACION TRANSMISION

SEAT	RUEDA	CAMBIO
ALHAMBRA	1225	1069
AROSA	1921	1632
FURA	1514E	0313
IBIZA 1.2 - 1.5 - SXI y 1.7 Diesel (hasta '93)	1514E	1636 (rodamiento de 25.8 mm)
IBIZA '93-CORDOBA 1.05-1.3-1.4-1.6 hasta '94	1359E	1632
IBIZA '93-CORDOBA 1.0-1.3-1.4 desde '94	1921	1632
IBIZA '93-CORDOBA Diesel hasta '94	1359E	1455
IBIZA '93-CORDOBA 1.8-2.0-TD y 16v hasta '94	1575E	1560 (Izqd.) - 1637 (Dcha.)
IBIZA '93-CORDOBA-1.8-2.0-D-TD-TDi desde '94 (Ø 77 mm)	1921	1192 (Ø 100)-1106 (Ø 94)
IBIZA '93-CORDOBA 1.6-1.8-2.0-D-TD-TDi desde '94 (Ø 86 mm)	1297	1192 (Ø 100)-1106 (Ø 94)
IBIZA '93-CORDOBA 1.9TDi 115-130cv	1102	1106
INCA 1.4-1.6(motor AEE)	1921	1632
INCA 1.6-1.9SDi	1921	1106 (Ø 94)
INCA 1.9TDi	1297	1192 (Ø 100)
LEON 1.4-1.6(105cv)-1.9SDi	1921	1106 (Ø 94)
LEON 1.6(100-102cv)-1.8-2.0	1297	1192 (Ø 100)
LEON 1.9TDi de 90-100-110cv	1297	1560 (Izqd.) - 1637 (Dcha.)
LEON 1.9TDi de 130-150cv	1297	1192 (Ø 100)
MALAGA 1.2 - 1.5 - SXI y 1.7 Diesel	1297	1560 (Izqd.) - 1637 (Dcha.)
MARBELLA	1102	1192 (Ø 100)
PANDA	1514E	1636 (rodamiento de Ø 25.8 mm)
RITMO-RONDA 1.2 - 1.5 y Diesel	1514E	1636 (rodamiento de Ø 25.8 mm)
TERRA gasolina	1514E	1054 (rodamiento de Ø 25.8 mm)
TERRA 1.3 Diesel y 1.4 Diesel	1170	0176
TOLEDO 1.6-1.9Diesel hasta '94	1514E	0313
TOLEDO 1.8-2.0/16v-1.9TurboD hasta '94	1514E	1636 (rodamiento de Ø 25.8 mm)
TOLEDO 1.4-1.6(105cv)-1.9SDi desde '94	1577	1632
TOLEDO '98 y '04- 1.4-1.6(105cv)-1.9SDi	1359E	1455
TOLEDO '98 y '04- 1.6(100-102cv)-1.8-2.0	1575E	1560 (Izqd.) - 1637 (Dcha.)
TOLEDO '98 y '04- 1.9TDi de 90-100-110cv	1921	1106 (Ø 94)
TOLEDO '98 y '04- 1.9TDi de 130-150cv	1921	1106 (Ø 94)
TRANS (gasolina)	1297	1192 (Ø 100)
127	1297	1560 (Izqd.) - 1637 (Dcha.)
	1297	1192 (Ø 100)
	1102	1560 (Izqd.) - 1637 (Dcha.)
	1170	1192 (Ø 100)
	1170	0176
	1170	0176
<b>SKODA</b>		
FAVORIT-FELICIA	1359E	1455
OCTAVIA 1.4-1.6(105cv)-1.9SDi	1921	1106 (Ø 94)
OCTAVIA 1.6(100-102cv)-1.8-2.0	1297	1192 (Ø 100)
OCTAVIA 1.9TDi de 90-100-110cv	1297	1560 (Izqd.) - 1637 (Dcha.)
	1297	1192 (Ø 100)
	1297	1560 (Izqd.) - 1637 (Dcha.)
<b>SUZUKI</b>		
VITARA	1854	n/d
SWIFT	1959	n/d

n/d = no disponible



## KIT REPARACION TRANSMISION

### TOYOTA

	RUEDA	CAMBIO
CARINA E (piña de Ø 82 mm)	2373	n/d
CARINA E (piña de Ø 77 mm)	1052	n/d

### VOLKSWAGEN

CADDY 1.4-1.6(AEE)	1921	1632
CADDY 1.6(1F)-1.9SDi	1297	1192
CORRADO	1575E	1560 (Izqd.) - 1637 (Dcha.)
GOLF-1	1359E	1455
GOLF-2/JETTA 1.3	1359E	1632
GOLF-2/JETTA 1.6-1.6 Diesel	1359E	1455
GOLF-2/JETTA 1.8 GTI, 16v, G60 y 1.6TurboD	1575E	1560 (Izqd.) - 1637 (Dcha.)
GOLF-3/VENTO (junta de Ø 78 mm hasta '94)	1921	1560 (Izqd.) - 1637 (Dcha.)
GOLF-3/VENTO (junta de Ø 88 mm hasta '94)	1297	1560 (Izqd.) - 1637 (Dcha.)
GOLF-3/VENTO (junta de Ø 78 mm desde '94)	1921	1192
GOLF-3/VENTO (junta de Ø 88 mm desde '94)	1297	1192
GOLF-4/BORA 1.4-1.6(105cv)-1.9SDi	1921	1106 (Ø 94)
GOLF-4/BORA 1.6(100-102cv)-1.8-2.0	1297	1192 (Ø 100)
GOLF-4/BORA 1.9TDi de 90-100-110cv	1297	1560 (Izqd.) - 1637 (Dcha.)
GOLF-4/BORA 1.9TDi de 130-150cv	1102	2308 (Ø 107)
Lupo	1921	1632
PASSAT hasta '88-SANTANA 4 cilindros	1359E	1529
PASSAT hasta '88-SANTANA 5 cilindros	1575E	1529
PASSAT desde '88 hasta '96	1642E	1560 (Izqd.) - 1637 (Dcha.)
PASSAT '97 (junta de Ø 95 mm)	1187	1560 (Ø 100) / 2308 (Ø 107)
PASSAT'97 (junta de Ø 95 mm)	1297	1560 (Ø 100) / 2308 (Ø 107)
PASSAT'97 (junta de Ø 81 mm)	1732E	1560 (Ø 100) / 2308 (Ø 107)
POLO '84 1.05-1.3 motor HK	1689E	1632
POLO '84 1.3 motores MH - 2G y 1.4 Diesel (tr. derecha)	1689E	1632
POLO '84 1.3 motores MH - 2G y 1.4 Diesel (tr. izquierda)	1359E	1632
POLO '95 1.05-1.3-1.4-1.6(salvo GTi)	1921	1632
POLO '95 1.6 GTi	1297	1632
POLO '95 1.7SDi-1.9D-1.9SDi	1921	1061
SHARAN	1225	1069
TRANSPORTER hasta '98	1187	1069/2308 (Ø 107)
TRANSPORTER desde '98	1225	1069/2308 (Ø 107)

### VOLVO

850	1732E	n/d
-----	-------	-----

### UNIVERSAL (para montar con cono / útil neumático)

turismos	1635
furgonetas y 4x4	1063
microcoches (Ayxam, Ligier, etc.)	1285

## KIT REPARACION CREMALLERA







DEUNFUELLE,

Contenido de la caja:

1 fuelle  
bridas de nylon de longitud variable  
bolsa de grasa de 20 g.

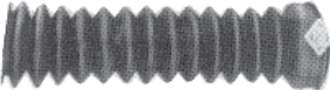

## ALFA ROMEO - AUDI

 <p><b>1773</b> asistida ALFA 33</p> <p>Ø bocas 38-52 mm r.o. 36020076</p>	 <p><b>1835</b> asistida ALFA 145-146-147-155</p> <p>Ø bocas 11-55 mm r.o.</p>
 <p><b>1530</b> asistida ALFA 156</p> <p>Ø bocas 11-42 mm r.o.</p>	
 <p><b>1573</b> AUDI 80 - 90</p> <p>Ø bocas 28-45 mm r.o. 811419831B</p>	 <p><b>1772</b> AUDI 100 - 200 AUDI A6</p> <p>Ø bocas 48-40 mm r.o. 431419831</p>
 <p><b>1300</b> izquierdo AUDI A4</p> <p>Ø bocas 18-54 mm r.o. 4D0419831B/D</p>	 <p><b>1369</b> derecho AUDI A4</p> <p>Ø bocas 18 - 60 mm r.o. 8D0419831J</p>
 <p><b>1479</b> AUDI A3</p> <p>Ø bocas 16-49 mm r.o.</p>	

## KIT REPARACION CREMALLERA





### BMW - FIAT - LANCIA

### CITROEN: ver PEUGEOT

 <p><b>1538</b> izquierdo - manual BMW serie 3</p> <p>Ø bocas 54-54 mm r.o. r.o. 32111117426</p>	 <p><b>1539</b> derecho - manual BMW serie 3</p> <p>Ø bocas 38-44 mm r.o. 32111118688</p>
 <p><b>1305</b> asistida BMW series 3 y 5</p> <p>Ø bocas 38-51 mm r.o. 32211139786-32131092876</p>	 <p><b>1196</b> FIAT DOBLO</p> <p>Ø bocas 15-55 mm r.o.</p>
 <p><b>1258</b> izquierdo FIAT UNO FIAT REGATA LANCIA Y10 LANCIA DELTA-PRISMA</p> <p>Ø bocas 10-43 mm r.o. 4371155</p>	 <p><b>1257</b> derecho FIAT UNO FIAT REGATA LANCIA Y10 LANCIA DELTA-PRISMA</p> <p>Ø bocas 10-25 mm r.o. 4371156</p>
 <p><b>1835</b> asistida FIAT BRAVO-BRAVA FIAT MAREA FIAT PUNTO FIAT TIPO FIAT MULTIPLA Ø bocas 11-55 mm r.o.</p>	 <p><b>1370</b> FIAT SCUDO-ULYSSE LANCIA ZETA</p> <p>Ø bocas 13-62 mm r.o.</p>
 <p><b>1617</b> manual FIAT TIPO</p> <p>Ø bocas 10-44 mm r.o. 7566840</p>	 <p><b>1820</b> asistida DUCATO</p> <p>Ø bocas 15-54 mm r.o. 9941077</p>
 <p><b>1621</b> manual izquierdo DUCATO</p> <p>Ø bocas 12-48 mm r.o. 9750000280</p>	 <p><b>1620</b> manual derecho DUCATO</p> <p>Ø bocas 12-38 mm r.o. 9750000380</p>
 <p><b>1758</b> izquierdo asistida FIAT CROMA LANCIA THEMA</p> <p>Ø bocas 10-48 mm r.o.</p>	 <p><b>1757</b> derecho asistida FIAT CROMA LANCIA THEMA</p> <p>Ø bocas 10-44 mm r.o.</p>







## KIT REPARACION CREMALLERA

### FORD - HONDA - HYUNDAI - LADA - NISSAN

 <p><b>1534</b> manual FIESTA '83 ESCORT '84 - ORION</p> <p>Ø bocas 11-36 mm r.o. 6127744-6935233</p>	 <p><b>1527</b> manual y asistida SIERRA SCORPIO</p> <p>Ø bocas 12-47 mm r.o. 1610365</p>
 <p><b>1197</b> asistida FIESTA '96 - COURIER KA</p> <p>Ø bocas 11-48 mm r.o. 7138854</p>	 <p><b>1351</b> FORD FOCUS</p> <p>Ø bocas 13-47 mm r.o.</p>
 <p><b>1995</b> MONDEO</p> <p>Ø bocas 17-58 mm r.o. 6722173</p>	 <p><b>1321</b> GALAXY</p> <p>Ø bocas 10-49 mm r.o. 7398680</p>
 <p><b>1141</b> FIESTA '02 - FUSION</p> <p>Ø bocas 14-55 mm r.o. 4330628</p>	 <p><b>1196</b> manual y asistida TRANSIT '85, '92 y '95</p> <p>Ø bocas 15-55 mm r.o.</p>
 <p><b>1138</b> izquierdo TRANSIT '00-</p> <p>Ø bocas 14-60 mm r.o. 4059921</p>	 <p><b>1137</b> derecho TRANSIT '00-</p> <p>Ø bocas 14-65 mm r.o. 4059922</p>
 <p><b>1346</b> asistida HONDA CIVIC-ACCORD HONDA CONCERTO r.o. 53534-SV4N01 NISSAN MICRA NISSAN BLUEBIRD r.o. 48203-Q0301 Ø bocas 9-45 mm</p>	 <p><b>1347</b> asistida HYUNDAI IPONIA HYUNDAI LANTRA HYUNDAI ACCENT HYUNDAI LANTRA</p> <p>Ø bocas 9-39 mm r.o.</p>
 <p><b>1348</b> NISSAN PRIMERA NISSAN ALMERA</p> <p>Ø bocas 12-47 mm r.o. 48203-Q9025</p>	

## KIT REPARACION CREMALLERA

### OPEL

 <p><b>1338</b> manual CORSA</p> <p>Ø bocas 13-49 mm r.o.</p>	 <p><b>1191</b> asistida CORSA B - C</p> <p>Ø bocas 12-49 mm r.o. 1609087</p>
 <p><b>1550</b> KADETT ASCONA VECTRA-A</p> <p>Ø bocas 12-49 mm r.o. 91105983</p>	 <p><b>1773</b> asistida "ZF" KADETT-ASCONA VECTRA-A ASTRA-F</p> <p>Ø bocas 38-52 mm r.o.</p>
 <p><b>1822</b> asistida "SAGINAW" ASTRA-F KADETT VECTRA-A</p> <p>Ø bocas 58-53 mm r.o.</p>	 <p><b>1107</b> asistida ASTRA-G ZAFIRA</p> <p>Ø bocas 13-53 mm r.o.</p>
 <p><b>1108</b> asistida "ZF" o "SAGINAW" VECTRA-B</p> <p>Ø bocas 14-48 mm r.o.</p>	







## KIT REPARACION CREMALLERA

### PEUGEOT - CITROËN

 <p><b>1307</b> manual, derecho e izquierdo asistida, derecho CITROENBX</p> <p>Ø bocas 11-46 mm r.o. 95496072</p>	 <p><b>1308</b> asistida izquierdo CITROEN BX</p> <p>Ø bocas 40-50 mm r.o. 95604346</p>
 <p><b>1268</b> manual, derecho e izquierdo asistida izquierdo CITROEN VISA-C15-ZX 205-306-309-405-505 BERLINGO-PARTNER asistida XSARA asistida Ø bocas 11-41 mm r.o. 4066.15-4066.43</p>	 <p><b>1536</b> asistida derecho CITROENC15-ZX 205-309-505 BERLINGO-PARTNER XSARA 406 "asistida no variable" Ø bocas 39-39 mm r.o. 4066.22</p>
 <p><b>1845</b> asistida derecho 306-405 XANTIA 406 "asistida variable"</p> <p>Ø bocas 45-45 mm r.o. 4066.28-4066.52</p>	 <p><b>1609</b> manual y asistida CITROEN AX PEUGEOT 106 hasta '98 SAXO hasta '98</p> <p>Ø bocas 40-22 mm r.o.</p>
 <p><b>1064</b> CITROEN SAXO desde '98 PEUGEOT 106 desde '98</p> <p>Ø bocas 40-22 mm r.o.</p>	 <p><b>1310</b> manual derecho e izquierdo asistida izquierdo XANTIA hasta '97</p> <p>Ø bocas 11-44 mm r.o. 4066.29</p>
 <p><b>1479</b> manual PEUGEOT 206</p> <p>Ø bocas 16-49 mm r.o.</p>	 <p><b>1480</b> asistida PEUGEOT 206 PEUGEOT 307 CITROENC4</p> <p>Ø bocas 17-60 mm r.o.</p>
 <p><b>1740</b> manual izquierdo BERLINGO PARTNER XSARA PICASSO PEUGEOT 306 desde '97</p> <p>Ø bocas 11-42 mm r.o.</p>	 <p><b>1648</b> manual derecho BERLINGO PARTNER PEUGEOT 306 desde '97</p> <p>Ø bocas 11-42 mm r.o.</p>
 <p><b>1515</b> asistida izquierdo XANTIA desde '97 PEUGEOT 406 "asist. variable"</p> <p>Ø bocas 16-43 mm r.o.</p>	 <p><b>1470</b> asistida izquierdo PEUGEOT 406 "asistida no variable"</p> <p>Ø bocas 21-58 mm r.o.</p>



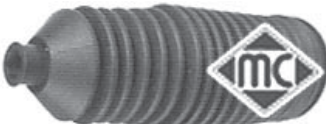





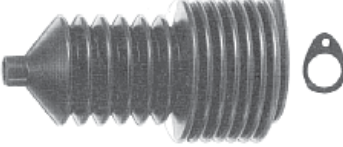

## KIT REPARACION CREMALLERA

### PEUGEOT-CITROËN

 <p><b>1621</b> manual izquierdo PEUGEOTJ5 CITROENC25</p> <p>Ø bocas 12-48 mm r.o.</p>	 <p><b>1620</b> manual derecho PEUGEOTJ5 CITROENC25</p> <p>Ø bocas 12-38 mm r.o.</p>
 <p><b>1820</b> asistida CITROENC25 PEUGEOTJ5 JUMPER BOXER</p> <p>Ø bocas 12-48 mm r.o.</p>	 <p><b>1370</b> JUMPY-EVASION EXPERT-806</p> <p>Ø bocas 12-62 mm r.o.</p>
 <p><b>1121</b> C2 C3</p> <p>Ø bocas 14-50 mm r.o.</p>	 <p><b>1125</b> C5</p> <p>Ø bocas 21-58 mm r.o. 4066.64</p>

## KIT REPARACION CREMALLERA

### RENAULT

 <p><b>1195</b> R 4 - R 5 - R 6 - R 7 (hasta '78)</p> <p>Ø bocas -33 mm r.o. 7700554294</p>	 <p><b>1263</b> R 4 TL - R 5 - R 6 - R 14 desde '78</p> <p>Ø bocas 11-33 mm r.o. 7700656569</p>
 <p><b>1265</b> manual R 18 - FUEGO - ESPACE</p> <p>Ø bocas 10-40 mm r.o. 7700653459</p>	 <p><b>1561</b> asistida R 18 - FUEGO - ESPACE R 19 - CLIO-1 - EXPRESS TRAFIC - MASTER R 21 GTS - R 25 GTS</p> <p>Ø bocas 10-40 mm r.o. 7700781095</p>
 <p><b>1350</b> manual R 9 - R 11 - SUPER5 ESPRESS - R 19 - R 21 GTS CLIO-1</p> <p>Ø bocas 11-31 mm r.o. 7700678649</p>	 <p><b>1136</b> LAGUNA-II</p> <p>Ø bocas 13-51 mm r.o. 7701472765</p>
 <p><b>1266</b> manual derecho TRAFIC hasta '98</p> <p>Ø bocas 11-31 mm r.o. 7700680852</p>	 <p><b>1356</b> asistida "TRW" MEGANE derecho e izquierdo CLIO-2 - KANGOO derecho</p> <p>Ø bocas 11-31 mm r.o. 6000025546</p>
 <p><b>1355</b> asistida LAGUNA-I - SAFRANE</p> <p>Ø bocas 12-44 mm r.o. 7701469657</p>	 <p><b>1647</b> manual CLIO-2 - KANGOO</p> <p>Ø bocas 9-38 mm r.o.</p>
 <p><b>1530</b> asistida "TRW" izquierdo CLIO-2 - KANGOO</p> <p>Ø bocas 11-42 mm r.o.</p>	 <p><b>1558</b> asistida "SMI" CLIO-2 - KANGOO MEGANE</p> <p>Ø bocas 9-39 mm r.o.</p>

## KIT REPARACION CREMALLERA

### SEAT (derivados FIAT)



**1258**  
izquierdo  
127 - PANDA - RITMO  
TRANS - TERRA  
MALAGA - IBIZA hasta '93

Ø bocas 10-43 mm  
r.o. SE-138162132A



**1257**  
derecho  
127 - PANDA - RITMO  
TRANS - TERRA  
MALAGA - IBIZA hasta '93

Ø bocas 10-25 mm  
r.o. SE-138162131A



**1758**  
asistida izquierdo  
SEAT 131 2.5 Diesel Sofim

Ø bocas 10-48 mm  
r.o.



**1757**  
asistida derecho  
SEAT 131 2.5 Diesel Sofim

Ø bocas 10-44 mm  
r.o.



## KIT REPARACION CREMALLERA

### SKODA - SEAT - VOLKSWAGEN

 <p><b>1507</b> manual POLO '84 a '95</p> <p>Ø bocas 22-34 mm r.o. 861419831B</p>	 <p><b>1357</b> asistida POLO '95 LUPO 1.4TDi-1.2FSi</p> <p>Ø bocas 11-42 mm r.o. 6N0422831</p>
 <p><b>1436</b> manual SEAT AROSA VW POLO '95 VW LUPO</p> <p>Ø bocas 25-40 mm r.o.</p>	 <p><b>1511</b> manual SEAT IBIZA '93 - INCA SEAT TOLEDO VW CADDY VW GOLF-2/3 VW PASSAT '88 a '96 Ø bocas 25-41 mm r.o. 191419831</p>
 <p><b>1765</b> asistida "TRW" SEAT IBIZA '93 - INCA SEAT TOLEDO VW CADDY VW GOLF-2 - 3 VW PASSAT '88 a '96 Ø bocas 9-40 mm r.o. 191422831</p>	 <p><b>1100</b> asistida "ZF" VW GOLF-3</p> <p>Ø bocas 13-45 mm r.o.</p>
 <p><b>1321</b> asistida VW SHARAN SEAT ALHAMBRA</p> <p>Ø bocas 10-49 mm r.o. 7M0422831</p>	 <p><b>1479</b> asistida SEAT TOLEDO '99 SEAT LEON SKODA OCTAVIA VW GOLF-4</p> <p>Ø bocas 16-49 mm r.o.</p>
 <p><b>1300</b> izquierdo VW PASSAT '97</p> <p>Ø bocas 18-54 mm r.o. 4D0419831B/D</p>	 <p><b>1369</b> derecho VW PASSAT '97</p> <p>Ø bocas 18-60 mm r.o. 8D0419831J</p>
 <p><b>1062</b> VW TRANSPORTER</p> <p>Ø bocas 25-46 mm r.o. 701419831</p>	 <p><b>1573</b> manual VW PASSAT hasta '88</p> <p>Ø bocas 28-45 mm r.o. 811419831B</p>



### FUELLES UNIVERSALES

---

#### 1634

UNIVERSAL para CREMALLERAS MANUALES

adaptable en combinación de los siguientes diámetros:  
boca pequeña: Ø 10 - 23 - 30 - 40 mm

boca grande: Ø 28 - 36 - 41 - 46 - 54 mm



---

#### 1201

UNIVERSAL para CREMALLERAS ASISTIDAS

adaptable en combinación de los siguientes diámetros:  
boca pequeña: Ø 10 - 23 - 30 - 40 mm

boca grande: Ø 28 - 36 - 41 - 46 - 54 mm



# KIT REPARACION CREMALLERA

## COMPLETOS

### CAJA CONTENIENDO:



FUELLE DERECHO Y FUELLE IZQUIERDO

ABRAZADERAS de nylon

CASQUILLOS interiores o ACCESORIOS (según modelos)

BOLSA DE GRASA de 20 g para facilitar el montaje

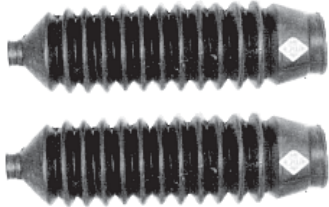
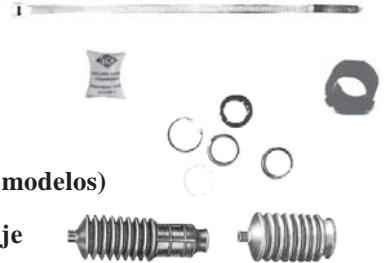

### 1534-C

manual  
FORD FIESTA - COURIER  
FORDESCORT  
FORD KA - PUMA

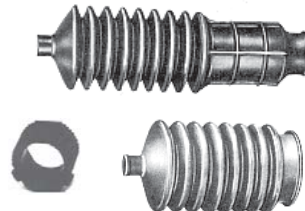

### 1257-C

manual  
SEAT PANDA-TRANS  
IBIZA hasta '93 - MALAGA  
SEAT TERRA  
FIAT UNO-REGATA  
LANCIA Y10 - DELTA



### 1550-C

manual  
OPEL KADETT  
OPEL ASCONA  
OPEL VECTRA-A  
OPEL CALIBRA

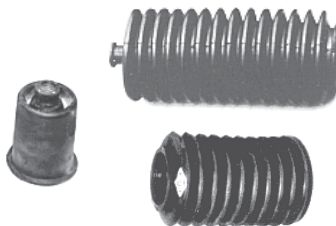

### 1845-C

asistida  
PEUGEOT 306 - 405  
PEUG. 406 asistida no variable  
CITROEN XANTIA

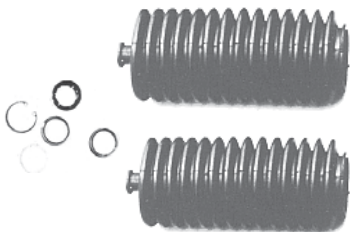

### 1268-C

manual  
CITROEN C15 - VISA  
CITROEN ZX  
PEUGEOT 205 - 309  
PEUGEOT 405 - 505

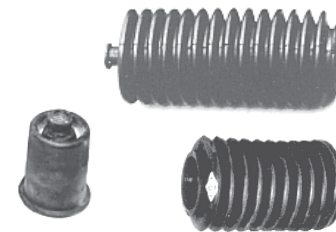

### 1536-C

asistida  
CITROEN C15  
CITROEN ZX - XSARA  
PEUGEOT 205-309-505



### 1609-C

manual y asistida  
CITROEN AX  
PEUGEOT 106 hasta '98  
CITROEN SAXO hasta '98

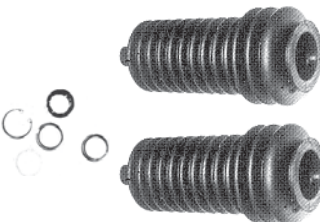

### 1263-C

manual  
RENAULT 4-5-6 (desde '78)

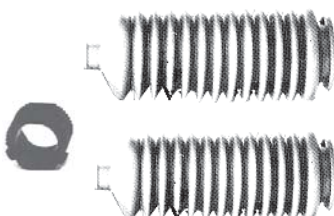

### 1350-C

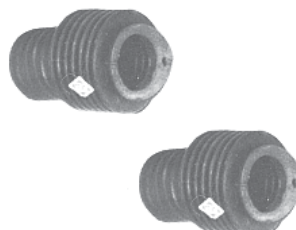

manual  
R9-R 11-Super5  
EXPRESS - R 19 - R 21GTS  
R 25GTS  
CLIO hasta '98  
MEGANE hasta '98



### 1561-C

asistida  
R 19 - EXPRESS - CLIO-I  
R 18 - FUEGO - ESPACE  
R 21GTS - TRAFIC hasta '96  
MASTER hasta '96  
MEGANE hasta '98

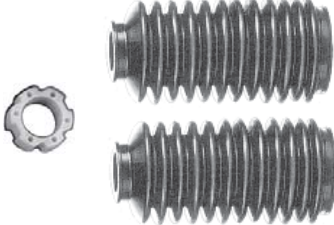
## KIT REPARACION CREMALLERA

	<p><b>1511-C</b> manual SEAT IBIZA desde '93 SEAT TOLEDO hasta '99 VW GOLF-2 VW GOLF-3 VW PASSAT '88 a '96 VW CADDY - SEAT INCA</p>		<p><b>1765-C</b> asistida "TRW" SEAT IBIZA desde '93 SEAT TOLEDO hasta '99 VW GOLF-2 VW GOLF-3 VW PASSAT '88 a '96 VW CADDY - SEAT INCA</p>
	<p><b>1100-C</b> asistida "ZF"  VW GOLF-3</p>		

## KIT REPARACION CREMALLERA RESUMEN DE APLICACIONES

### ALFA ROMEO

ALFA 33  
ALFA 33 - 145  
  
ALFA 145-146-147-155  
ALFA 156

ASISTIDA  
ASISTIDA ZF  
  
ASISTIDA  
ASISTIDA

IZQD.	DCHO.	COMPL.
1773	1773	
	2312 (único)	
1835	1835	
1530	1530	

### AUDI

80 - 90  
100 - 200 - A6 - A8  
A3  
A4

	1573 (único)
	1772 (único)
1479	1479
1300	1369

### BMW

serie 3  
serie 3

MANUAL  
ASISTIDA

1538	1539
1305	1305

### CITROËN

C15 - VISA  
C25  
C25  
AX  
BERLINGO  
BERLINGO  
BX  
BX  
C2  
C3  
C5

MANUAL  
ASISTIDA  
  
MANUAL  
ASISTIDA  
MANUAL  
ASISTIDA

1268	1268	1268-C
1621	1620	
1820	1820	
	1609 (único)	1609-C
1740	1648	
1268	1845	1845-C
1307	1307	
1308	1307	
1121	1121	
1121	1121	
1125	1125	

## KIT REPARACION CREMALLERA

CITROEN (cont.)		IZQD.	DCHO.	COMPL.
JUMPER		1820	1820	
JUMPY - EVASION		1370	1370	
SAXO hasta '98			1609 (único)	1609-C
SAXO desde '98			1064 (único)	
XANTIA	MANUAL	1310	1310	
XANTIA hasta '97	ASISTIDA	1310	1845	
XANTIA desde '97	ASISTIDA	1515	1845	
XSARA		1268	1536	1536-C
XSARA PICASSO		1740	1536	
ZX	MANUAL	1268	1268	1268-C
ZX	ASISTIDA	1268	1845	1845-C

### FIAT

BRAVO-BRAVA		1835	1835	
CROMA	ASISTIDA	1758	1757	
DOBLO		1196	1196	
DUCATO	MANUAL	1621	1620	
DUCATO-DAILY	ASISTIDA	1820	1820	
FIORINO		1258	1257	1257-C
MAREA	ASISTIDA	1835	1835	
MULTIPLA		1835	1835	
PUNTO-I/II	MANUAL	1617	1617	
PUNTO-I/II	ASISTIDA	1835	1835	
REGATA	MANUAL	1258	1257	
SCUDO		1370	1370	
TIPO-TEMPRA	MANUAL	1617	1617	
TIPO-TEMPRA	ASISTIDA	1835	1835	
ULYSSE		1370	1370	
UNO	MANUAL	1258	1257	1257-C

### FORD

CONNECT		1351	1351	
ESCORT - ORION	MANUAL	1534	1534	
ESCORT - ORION	ASISTIDA	1527	1527	
FIESTA '83-'89-'96	MANUAL	1534	1534	1534-C
FIESTA - COURIER	ASISTIDA	1197	1197	
FIESTA '02- FUSION		1141	1141	
FOCUS		1351	1351	
GALAXY		1321	1321	
KA	MANUAL	1534	1534	
KA	ASISTIDA	1197	1197	
MONDEO	ASISTIDA	1995	1995	
SIERRA - SCORPIO		1527	1527	
TRANSIT 85-92-95		1196	1196	
TRANSIT '00-		1138	1137	

### HONDA

CIVIC - ACCORD	ASISTIDA	1346	1346	
CONCERTO	ASISTIDA	1346	1346	

### HYUNDAI

TODOS MODS.	ASISTIDA	1347	1347	
-------------	----------	------	------	--

### LANCIA

Y10 - DELTA - PRISMA	MANUAL	1258	1257	1257-C
PRISMA - DELTA	ASISTIDA	1258	1615	
DEDRA - THEMA	ASISTIDA	1758	1757	

## KIT REPARACION CREMALLERA

NISSAN		IZQD.	DCHO.	COMPL.
MICRA -BLUEBIRD	ASISTIDA	1346	1346	
PRIMERA	ASISTIDA	1348	1348	
<b>OPEL</b>				
ASCONA	MANUAL	1550	1550	1550-C
ASCONA	ASISTIDA "ZF"	1773	1773	
ASTRA-F	ASISTIDA "SAGINAW"		1822 (único)	
ASTRA-F	ASISTIDA "ZF"	1773	1773	
ASTRA-G		1107	1107	
CORSA	MANUAL	1338	1338	
CORSA-B/C TIGRA	ASISTIDA	1191	1191	
KADETT	MANUAL	1550	1550	1550-C
KADETT	ASISTIDA "ZF"	1773	1773	
VECTRA-A -CALIBRA	MANUAL	1550	1550	1550-C
VECTRA-A -CALIBRA	ASISTIDA "ZF"	1773	1773	
VECTRA-A -CALIBRA	ASISTIDA "SAGINAW"		1822 (único)	
VECTRA-B		1108	1108	
ZAFIRA		1107	1107	
<b>PEUGEOT</b>				
106 hasta '98			1609 (único)	
106 desde '98			1064 (único)	
205 - 309	MANUAL	1268	1268	1268-C
205 - 309	ASISTIDA	1268	1536	1536-C
206	MANUAL	1479	1479	
206	ASISTIDA	1480	1480	
306 hasta '97	MANUAL	1268	1268	1268-C
306 desde '97	MANUAL	1740	1648	
306	ASISTIDA	1268	1845	1845-C
306	ASISTIDA	1268	1845	1845-C
307		1480	1480	
405	MANUAL	1268	1268	1268-C
405 hasta '93	ASISTIDA	1268	1845	1845-C
405 desde '93	ASISTIDA	1310	1845	
406	ASISTIDA "VARIABLE"	1515	1845	
406	ASISTIDA "NO VARIABLE"	1470	1845	
505	ASISTIDA	1268	1536	1536-C
406	ASISTIDA	1310	1845	
BOXER		1820	1820	
EXPERT - 806		1370	1370	
J5	MANUAL	1621	1620	
J5	ASISTIDA	1820	1820	
PARTNER	MANUAL	1740	1648	
PARTNER	ASISTIDA	1268	1536	1536-C
<b>RENAULT</b>				
R 4 - R 5 - R 6 - R 7 (hasta '78)		1195	1195	
R 4 - R 5 - R 6 - R 7 (desde '78)		1263	1263	1263-C
R 14		1263	1263	1263-C
R 18	MANUAL	1265	1265	1265-C
R 18	ASISTIDA	1561	1561	1561-C
R 9 - R 11 - SUPER5 - EXPRESS		1350	1350	1350-C
R 19 - CLIO	MANUAL	1350	1350	1350-C
R 19 - CLIO	ASISTIDA	1561	1561	1561-C
R 21 GTS	MANUAL	1350	1350	1350-C
R 21 GTS	ASISTIDA	1561	1561	1561-C



## KIT REPARACION CREMALLERA

RENAULT (CONT.)		IZQD.	DCHO.	COMPL.
R 21 TXE y Diesel	ASISTIDA		n/d	
CLIO-1	MANUAL	1350	1350	1350-C
CLIO-1	ASISTIDA	1561	1561	1561-C
CLIO-2	MANUAL	1647	1647	
CLIO-2	ASISTIDA "TRW"	1530	1356	
CLIO-2	ASISTIDA "SMI"	1558	1558	
SPACE hasta '96	ASISTIDA	1561	1561	1561-C
SPACE desde '96	ASISTIDA	1355	1355	
KANGOO	MANUAL	1647	1647	
KANGOO	ASISTIDA "TRW"	1530	1356	
KANGOO	ASISTIDA "SMI"	1558	1558	
LAGUNA-I	ASISTIDA	1355	1355	
LAGUNA-II		1136	1136	
MASTER	MANUAL	1266	1265	
MASTER	ASISTIDA	1561	1561	1561-C
MEGANE-SCENIC	MANUAL	1350	1350	1350-C
MEGANE-SCENIC	ASISTIDA "TRW"	1356	1356	
MEGANE	ASISTIDA "SMI"	1558	1558	
SAFRANE	ASISTIDA	1355	1355	
TRAFIC	MANUAL	1266	1265	
TRAFIC	ASISTIDA	1561	1561	1561-C
TWINGO		1350	1350	1350-C

### SEAT

127-PANDA-TERRA-MARBELLA		1258	1257	1257-C
131 SOFIM 2.5	ASISTIDA	1758	1757	1757-C
AROSA		1436	1436	
ALHAMBRA		1321	1321	
IBIZA (hasta '93) - MÁLAGA		1258	1257	1257-C
IBIZA '93 - CORDOBA - INCA	MANUAL	1511	1511	1511-C
IBIZA '93 - CORDOBA - INCA	ASISTIDA	1765	1765	1765-C
LEON	ASISTIDA	1479	1479	
TOLEDO	MANUAL	1511	1511	1511-C
TOLEDO hasta '99	ASISTIDA	1765	1765	1765-C
TOLEDO desde '99 - ALTEA	ASISTIDA	1479	1479	

### VOLKSWAGEN

CADDY	MANUAL	1511	1511	1511-C
CADDY	ASISTIDA	1765	1765	1765-C
GOLF-2 - JETTA	MANUAL	1511	1511	1511-C
GOLF-2 - JETTA	ASISTIDA	1765	1765	1765-C
GOLF-3 - VENTO	MANUAL	1511	1511	1511-C
GOLF-3 - VENTO	ASISTIDA "TRW"	1765	1765	1765-C
GOLF-3 - VENTO	ASISTIDA "ZF"	1100	1100	1100-C
GOLF-4 - BORA		1479	1479	
GOLF-5		1479	1479	
LUPO	MANUAL	1436	1436	
LUPO	ASISTIDA	1357	1357	
PASSAT hasta '88			1573 (único)	
PASSAT desde '88 hasta '96	MANUAL	1511	1511	1511-C
PASSAT desde '88 hasta '96	ASISTIDA	1765	1765	1765-C
PASSAT desde '97		1300	1369	
POLO hasta '95			1507 (único)	
POLO desde '95	MANUAL	1436	1436	
POLO desde '95	ASISTIDA	1357	1357	
SANTANA			1573 (único)	
SHARAN		1321	1321	
TRANSPORTER		1062	1062	

### UNIVERSAL

CREMALLERAS MANUALES y ASISTIDAS	1634
CREMALLERAS ASISTIDAS (con tubo respiradero)	1201

## ABRAZADERAS PARA FUELLES

### ABRAZADERA UNIVERSAL DE NYLON



color blanco, en bolsas de 100 unidades:

<b>035</b>	corta,	4,8 x 190 mm, diámetro máximo cerrada 36 mm
<b>036</b>	mediana,	2,5 x 200 mm, diámetro máximo cerrada 50 mm
<b>037</b>	larga,	4,8 x 280 mm, diámetro máximo cerrada 70 mm
<b>038</b>	extralarga	4,8 x 370 mm, diámetro máximo cerrada 105 mm

color negro, en bolsas de 100 unidades:

<b>035-N</b>	corta,	4,8 x 190 mm, diámetro máximo cerrada 36 mm
<b>036-N</b>	mediana,	2,5 x 200 mm, diámetro máximo cerrada 50 mm
<b>037-N</b>	larga,	4,8 x 280 mm, diámetro máximo cerrada 70 mm
<b>038-N</b>	extralarga	4,8 x 370 mm, diámetro máximo cerrada 105 mm

### ABRAZADERAS PARA FUELLE TRANSMISION

de longitud variable con oreja de presión, en ACERO INOXIDABLE (flexibles !)  
bolsas de 50 unids.



<b>060 corta:</b>	21 - 45 mm
<b>067</b> (aplicaciones especiales)	45 - 68 mm
<b>070 larga:</b>	64 - 122 mm

fleje en acero inoxidable -tipo Citroën- (5 mm de ancho)



<b>012</b>	cierre para abrazadera de fleje (bolsas de 100 unidades)
------------	---

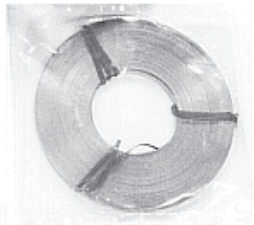

<b>014</b>	rollo 50 mts fleje <b>inoxidable</b> para abrazaderas
------------	---

## ABRAZADERAS TIPO SIN FIN



fabricadas en ACERO INOXIDABLE (tipo NORMA)

fleje y jaula: acero inoxidable

tornillo: acero cincado.  
cabeza hexagonal ranurada

ref.	medidas	banda	envase
0017	Ø 8 - 12 mm	8mm	100 u - P
0018	Ø 8 - 16 mm	9mm	100 u - P
0019	Ø 12 - 20 mm	9mm	100 u - M
0020	Ø 16 - 27 mm	9mm	100 u - M
0021	Ø 20 - 32 mm	9mm	100 u - G
0025	Ø 25 - 40 mm	9mm	100 u - G
0026	Ø 32 - 50 mm	9mm	50 u - G
0027	Ø 40 - 60 mm	9mm	50 u - G
0028	Ø 50 - 70 mm	9mm	50 u - G
0029	Ø 60 - 80 mm	9mm	25 u - G

P - caja pequeña  
M - caja mediana  
G - caja grande

## TUBO DE CARTON ALUMINIZADO

### TUBO FLEXIBLE DE CARTON ALUMINIZADO

capa interior de kraft encerado,

capa intermedia de aluminio

capa exterior de kraft negro

en tubos de 1 mt de longitud comprimidos a 50 cm.

<b>2201</b>	32mm
<b>2202</b>	35mm
<b>2203</b>	38mm
<b>2204</b>	40mm
<b>2205</b>	42mm
<b>2206</b>	45mm
<b>2207</b>	47mm
<b>2208</b>	50mm
<b>2209</b>	55mm
<b>2210</b>	60mm
<b>2211</b>	65mm
<b>2212</b>	70mm
<b>2213</b>	75mm



## TUBO de GASOLINA

### TUBO DE GASOLINA

(SEGUN NORMA DIN 73379)

#### DE GOMA SOLA

ENCARRETES DE PLASTICO RETRACTILADOS  
ROLLOS de 25 mt.

**354** Ø 3 x 7 mm (retorno de inyectores, rollo de 40 mts)

**470** Ø 3 x 7 mm (retorno de inyectores, rollo de 25 mts)

**311** Ø 4 x 8 mm

**312** Ø 5 x 11 mm

**322** Ø 7 x 13 mm



#### CON FORRO EXTERIOR DE ALGODON TRENZADO:

ENCARRETES DE PLASTICO ROJO RETRACTILADOS

ROLLOS de 25 mt:  
(Ø carrete 36 cm)

**500** Ø 3,0 x 7,0 mm

**501** Ø 6,0 x 13,0 mm

**502** Ø 7,5 x 13,5 mm

ROLLOS de 15 mt:  
(Ø carrete 17 cm)

**102** Ø 3,0 x 7,0 mm

**106** Ø 6,0 x 13,0 mm

**107** Ø 7,5 x 13,5 mm

**503** Ø 9,0 x 17,0 mm

**754** Ø 12,0 x 19,0 mm

**123** Ø 14,0 x 22,0 mm



#### CON REFUERZO TEXTIL INTERMEDIO (tipo GATES):

ENCARRETES DE PLASTICO ROJO RETRACTILADOS

ROLLOS de 25 mt:  
(Ø carrete 36 cm)

**755** Ø 4,0 x 9,0 mm

**745** Ø 6,0 x 12,0 mm

**746** Ø 7,5 x 13,5 mm

**747** Ø 10,0 x 17,0 mm

ROLLOS de 15 mt:  
(Ø carrete 17 cm)

**108** Ø 4,0 x 9,0 mm

**112** Ø 6,0 x 12,0 mm

**114** Ø 7,5 x 13,5 mm

**115** Ø 10,0 x 17,0 mm



**¡nuevo!**

**0039** EXPOSITOR para 6 CARRETES  
(incluye tijera)  
puede personalizarse





### TUBO PARA SERVOFRENOS

**Presión de trabajo 15 atm (rotura a 20 bar) con refuerzo textil intermedio de nylon.  
Rollos de 15 mts.**

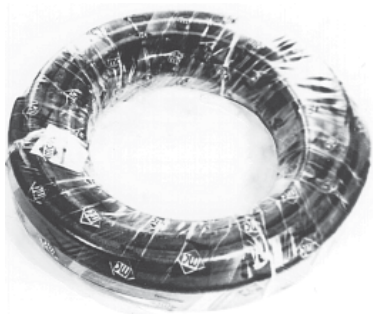

<b>472</b>	Ø 8 x 14 mm
<b>473</b>	Ø 10 x 16 mm
<b>474</b>	Ø 12 x 19 mm
<b>841</b>	Ø 16 x 25 mm
<b>503</b>	Ø 9 x 18 mm (con forro exterior de algodón trenzado)

### TUBO PASO DE AGUA de caucho EPDM con refuerzo textil

**Presión de trabajo 10 atm. Para sustituir manguitos de calefactor y vaso de expansión.  
Con refuerzo textil intermedio  
Rollos de 15 mts**

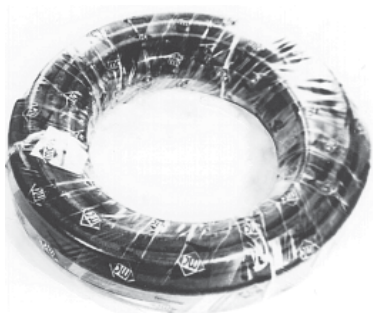

<b>760</b>	Ø 6 x 11 mm
<b>116</b>	Ø 8 x 15 mm
<b>117</b>	Ø 10 x 16 mm
<b>118</b>	Ø 13 x 19 mm
<b>119</b>	Ø 16 x 22 mm
<b>843</b>	Ø 19 x 25 mm
<b>754</b>	Ø 12 x 19 mm (trenzado exterior)

### TUBO SINTETICO PARA DESVAPORIZADORES

**en goma sintética resistente al aceite. Piezas de 1 mt. de longitud**

<b>861</b>	Ø 12 x 17 mm
<b>862</b>	Ø 14 x 19 mm
<b>131</b>	Ø 16 x 21 mm
<b>132</b>	Ø 20 x 25 mm



## TUBO DE PLASTICO-PVC AZUL

PVC transparente azul resistente a la gasolina. Rollos de 25 mts.



<b>031</b>	Ø 4x7,5 mm
<b>032</b>	Ø 6x 8 mm
<b>033</b>	Ø 8x10 mm
<b>034</b>	Ø 12x17 mm

## MANGUERA RECTA de caucho EPDM con refuerzo textil

Paso de agua. Con refuerzo textil intermedio. En piezas de 1 mt. de longitud

**9001** diámetro int. 20 mm

**9002** " 25 mm

**9003** " 30 mm

**9014** " 32 mm

**9004** " 35 mm

**9005** " 40 mm

**9006** " 45 mm



**9007** diámetro int. 50 mm

**9008** " 55 mm

**9009** " 60 mm

**9010** " 65 mm

**9011** " 70 mm

**9012** " 75 mm

**9013** " 80 mm

## CODOS de caucho EPDM con refuerzo textil

en ángulo recto, longitud 250 mm cada lado. Con refuerzo textil intermedio



**9618** Ø 20 mm

**9619** Ø 25 mm

**9620** Ø 30 mm

**9621** Ø 35 mm

**9622** Ø 40 mm

**9623** Ø 45 mm

**9624** Ø 50 mm

**9625** Ø 55 mm

**9626** Ø 60 mm









## CONECTORES PARA EMPALMAR TUBOS

**¡Nuevo!**

### 3694 - ESTUCHE DE CONECTORES DE PLASTICO UNIVERSALES



caja conteniendo 2 unidades de cada de los siguientes conectores:  
(reposiciones en bolsas de 12 unidades):

	<b>0043</b>	conector recto de 6 mm
	<b>0044</b>	conector recto de 10 mm
	<b>0045</b>	conector recto de 13 mm
	<b>0046</b>	conector recto de 16 mm
	<b>0047</b>	conector recto de 19 mm
	<b>0048</b>	conector recto en reducción de 13-10 mm
	<b>0049</b>	conector recto en reducción de 16-13 mm
	<b>0050</b>	conector recto en reducción de 19-16 mm

continua ./..



## CONECTORES PARA EMPALMAR TUBOS

**¡Nuevo!**

	<b>0051</b>	conector acodado de 6 mm
	<b>0052</b>	conector acodado de 10 mm
	<b>0055</b>	conector acodado de 13 mm
	<b>0061</b>	conector acodado de 16 mm
	<b>0062</b>	conector acodado de 19 mm
	<b>0063</b>	conector en "T" de 6-6-6 mm
	<b>0064</b>	conector en "T" de 10-10-10 mm
	<b>0065</b>	conector en "T" de 13-13-13 mm
	<b>0066</b>	conector en "T" de 16-16-16 mm
	<b>0068</b>	conector en "T" de 19-19-19 mm

## CONECTORES PARA EMPALMAR TUBOS







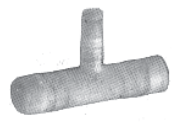

### CONECTORES METALICOS DE DOS VIAS, longitud 50 mm

	<b>3041</b>	Ø 10 - 10 mm
	<b>3042</b>	Ø 13 - 13 mm
	<b>3060</b>	Ø 16 - 16 mm
	<b>3043</b>	Ø 20 - 20 mm
	<b>3044</b>	Ø 32 - 32 mm

### CONECTORES METALICOS DE TRES VIAS, longitud total 65 mm, derivación 35 mm

	<b>3005</b>	Ø 10 - 10 - 10 mm
	<b>3045</b>	Ø 16 - 10 - 16 mm
	<b>3046</b>	Ø 20 - 10 - 20 mm
	<b>3047</b>	Ø 20 - 16 - 20 mm
	<b>3051</b>	Ø 20 - 20 - 20 mm
	<b>3048</b>	Ø 32 - 18 - 32 mm

### CONECTORES DE PLASTICO PARA APLICACIONES ESPECIFICAS:

	<b>691</b>	Ø 14 - 10 - 14 mm
	<b>644</b>	Ø 16 - 10 - 14 mm
	<b>3016</b>	empalme tubos de calefacción Renault 19 TXE, 9/11 GTX-TXE y Super5 GTX 90, 4 vias
	<b>2440</b>	Ø 8 - 8 - 8 mm (Citroën, tubos LHM)
	<b>2717</b>	empalme tubos de calefacción Ford Fiesta-Escort-Orion
	<b>2836</b>	empalme tubos Fiat Uno, con purgador
	<b>2837</b>	empalme tubos Fiat Uno - Lancia Y10
	<b>3733</b>	empalme tubos Mercedes Benz (con mgts)



## TAPONES DE BLOQUE

**FABRICADOS EN LATON (inoxidables)**

**Importante: La medida indicada es la del agujero a cubrir. El diámetro real del tapón es ligeramente superior para garantizar un ajuste perfecto.**

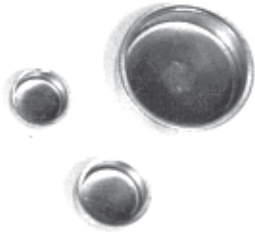

<b>2548</b>	8mm	<b>2515</b>	31.75mm
<b>2549</b>	9mm	<b>2516</b>	32mm
<b>2534</b>	10mm	<b>2542</b>	32.60mm
<b>2501</b>	12mm	<b>2517</b>	33.40mm
<b>2550</b>	12,50mm	<b>2518</b>	34mm
<b>2502</b>	13mm	<b>2564</b>	34,75mm
<b>2552</b>	13,50mm	<b>2519</b>	35mm
<b>2503</b>	14mm	<b>2520</b>	36mm
<b>2536</b>	14.50mm	<b>2532</b>	36.75mm
<b>2504</b>	15mm	<b>2521</b>	38mm
<b>2531</b>	16mm	<b>2543</b>	38.50mm
<b>2537</b>	16.50mm	<b>2571</b>	39,50mm
<b>2505</b>	17.40mm	<b>2522</b>	40mm
<b>2535</b>	18mm	<b>2523</b>	41.60mm
<b>2538</b>	19mm	<b>2544</b>	42mm
<b>2553</b>	19,50mm	<b>2545</b>	44mm
<b>2506</b>	20mm	<b>2572</b>	44,50mm
<b>2580</b>	21mm	<b>2525</b>	45mm
<b>2554</b>	22mm	<b>2546</b>	46mm
<b>2507</b>	22.20mm	<b>2573</b>	47mm
<b>2539</b>	23mm	<b>2547</b>	48mm
<b>2508</b>	24mm	<b>2574</b>	49mm
<b>2555</b>	24,30mm	<b>2528</b>	50mm
<b>2509</b>	25mm	<b>2529</b>	51mm
<b>2511</b>	25.60mm	<b>2533</b>	52mm
<b>2540</b>	26mm	<b>2575</b>	55,60mm
<b>2512</b>	27mm	<b>2576</b>	56mm
<b>2510</b>	27,50mm	<b>2577</b>	58mm
<b>2513</b>	28mm	<b>2578</b>	60mm
<b>2541</b>	28,60mm	<b>2579</b>	63mm
<b>2514</b>	30mm		

**especiales motores FIRE (FIAT - LANCIA):**

<b>2789</b>	Ø 50 / 66 mm Fiat Uno - Punto, etc.
<b>4893</b>	Ø 51 / 66 mm Fiat Uno - Punto, etc.



**¡Nuevo!**

## TAPONES CARTER ACEITE

	<b>2929</b> 10x150 PEUGEOT-CITROEN motores 1.9DW8		<b>678</b> 12x150 BMW MERCEDES benz		<b>2318</b> 12x125 NISSAN
	<b>4367</b> 12x150 KIA-HYUNDAI DAEWOO MITSUBISHI		<b>857</b> 14x150 MERCEDES BENZ		<b>674</b> 14x150 SEAT-VOLKSWAGEN AUDI-SKODA
	<b>677</b> 14x150 OPEL todos hasta '95 salvo TurboD (tuerca de 19 mm)		<b>669</b> 14x150 FORDFIESTA-ESCORT KA-COURIER-MONDEO TRANSIT		<b>2452</b> 14x125 PEUGEOT-CITROEN
	<b>2667</b> 14x150 OPEL todos desde '96 salvo TurboD (con junta tórica)		<b>2490</b> 14x150 OPEL 1.5-1.7TurboD		<b>2903</b> 14x150 FORDFOCUS (con junta de goma)
	<b>2916</b> 14x150 SEAT - VW - AUDI todos desde '98 (con junta plana)		<b>667</b> 16x150 RENAULT - CITROEN PEUGEOT		<b>670</b> 16x150 RENAULT
	<b>673</b> 16x150 CITROEN		<b>668</b> 18x150 RENAULT		<b>4062</b> 18x150 FIAT- ALFA ROMEO LANCIA
	<b>671</b> 20x150 PEUGEOT-TALBOT		<b>2398</b> 20x150 NISSAN		<b>4126</b> 20x150 FIAT- ALFA ROMEO LANCIA
	<b>675</b> 22x150(cónico) FIAT		<b>676</b> 22x150(cónico) FIAT		<b>672</b> 22x150 SEAT hasta '93
	<b>759</b> 26x150 MERCEDES VW Transporter		<b>4888</b> 26x150 MERCEDES <i>¡Nuevo!</i>		<b>5054</b> 24x150 MERCEDES <i>¡Nuevo!</i>
	<b>4714</b> <i>¡Nuevo!</i> 12x175 FORD2.5V6 JEEP		<b>4478</b> <i>¡Nuevo!</i> 14x150 MINI-II(BMW)		

## ARANDELAS

### ARANDELAS PLANAS grosor 1,5 mm (bolsas de 100 unidades)

#### COBRE:



<b>2029</b>	diámetro	10 x 16 mm
<b>2030</b>	"	12 x 17 mm
<b>2031</b>	"	14 x 20 mm
<b>2032</b>	"	16 x 22 mm
<b>2033</b>	"	18 x 24 mm
<b>2034</b>	"	20 x 26 mm
<b>2035</b>	"	22 x 28 mm
<b>2036</b>	"	24 x 30 mm
<b>2037</b>	"	26 x 32 mm

#### ALUMINIO:

<b>2039</b>	diámetro	10 x 16 mm
<b>2040</b>	"	12 x 17 mm
<b>2041</b>	"	14 x 20 mm
<b>2042</b>	"	16 x 22 mm

### ARANDELAS METALOPLASTICAS

de cobre rellenas de klingerit, sección tórica; bolsas de 100 unids.



<b>1999</b>	Ø 12 x 17 mm
<b>2000</b>	Ø 14 x 20 mm
<b>2050</b>	Ø 14 x 22 mm
<b>2001</b>	Ø 16 x 22 mm
<b>2002</b>	Ø 18 x 24 mm
<b>2004</b>	Ø 20 x 26 mm
<b>2005</b>	Ø 22 x 28 mm
<b>2006</b>	Ø 26 x 32 mm

### ARANDELAS METALICAS CON RETEN INTERIOR DE GOMA



<b>2024</b>	Ø 14 x 22 mm.
<b>2025</b>	Ø 16 x 24 mm.

**CITROËN ZX - XANTIA**  
**FORD** todos desde '92 hasta '98  
**CITROËN AX - BX - C/15**  
**RENAULT** 19-Clio-Mégane-Laguna

#### ESPECIALES FORD:



<b>2020</b>	Ø 14 x 22 mm.
<b>2021</b>	Ø 14 x 22 mm

**NYLON**

**GOMA** (sección plana-tórica, r.o. 1005593)  
 modelos d/ '98 (Focus - Puma - Mondeo '98)

#### ESPECIALES PEUGEOT-CITROËN:



<b>2050</b>	Ø 14 x 22 mm
<b>2051</b>	Ø 10 x 21 x 2 mm

**METALOPLASTICA** motores HDi

**PLANA de COBRE** motores 1.9 Diesel DW8

#### ESPECIALES NISSAN - VEHICULOS JAPONESES:



<b>2052</b>	Ø 12 mm
<b>2053</b>	Ø 14 mm

## PERFILES DE CARROCERIA / TUERCAS DE RUEDA

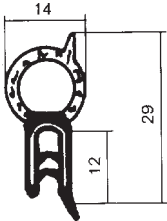
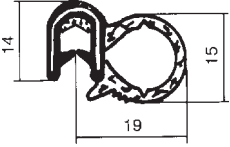
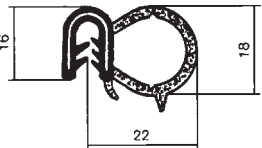
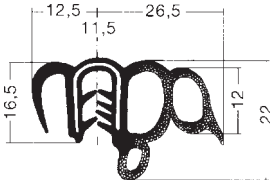
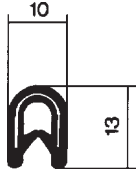
	<p style="text-align: center;"><b>600</b></p> <p>perfil contorno maletero universal bobinas de 50 mts</p>
	<p style="text-align: center;"><b>601</b></p> <p>perfil contorno puertas universal bobinas de 50 mts</p>
	<p style="text-align: center;"><b>602</b></p> <p>perfil contorno puertas sobremedida bobinas de 50 mts</p>
	<p style="text-align: center;"><b>774</b></p> <p>perfil contorno puertas VW Golf2-Seat Ibiza-Málaga-VW Polo bobinas de 50 mts</p>
	<p style="text-align: center;"><b>605</b></p> <p>perfil contorno chapa con ánima metálica bobinas de 50 mts</p>

### TUERCAS DE RUEDA

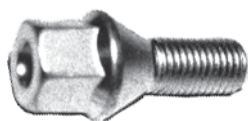

**792**

SEAT - VW - AUDI - SKODA

M-12/150 longitud rosca 22 mm



**4248**

SEAT - VW - AUDI - SKODA

M-14/150 longitud rosca 27 mm



**815**

OPEL



**933**

FORD

# POLEAS DE CIGUEÑAL BMW - CITROËN/PEUGEOT

## BMW



**4889** Ø 153 mm - 5 canales  
BMW series 3 E36 ('91-'98) y 5 E39 ('95-'04)  
motores 2.5td-tds  
r.o. 1123 2246511

## CITRÖEN - PEUGEOT (grupo PSA)



**4440** Ø 143 mm - 6 canales  
PSA motor TU1 1.1/TU3 1.4 gasolina  
Peugeot 206 1.1-1.4-C3  
r.o. 0515.R8-0515.P5



**4460** Ø 128 mm - 5 canales  
PSA motor TU5J2 (1.6/8v) y TU5J4 (1.6/16v)  
con aire acondicionado  
r.o. 0515.J3



**4442** Ø 146 mm - 6 canales  
Peugeot 206-307 1.6/16v  
Peugeot 206-307 TU3 1.4  
r.o. 0515.S1-0515.P1



**4569** Ø 150 mm - 6 canales  
Peugeot 307 TU3-1.4/TU5 1.6  
r.o. 0515.R4-0515.P7



**4439** Ø 138 mm - 5 canales  
Citroen Saxo 1.6 VTS  
sin aire acondicionado  
r.o. 0515.K8

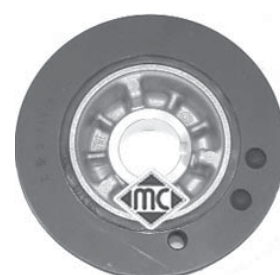

**4485** Ø 127 mm - 6 canales  
PSA motor XU7 (1.8)-XU10 (2.0)  
306-405-Jumpy-406-Xantia  
r.o. 0515.H6



**4562** Ø 149 mm - 6 canales  
PSA motores EW7 (1.8)-EW10 (2.0)  
Citroën C5 1.8-2.0  
r.o. 0515.R1



**4443** Ø 149 mm - 6 canales  
PSA motores 2.0/16v  
206-307  
r.o. 0515.S6-0515.N3



**4481** Ø 127 mm - 6 canales  
PSA motores 1.8/16v (XU7JP4) y 2.0/16v  
(XU10JP4), 306-406-605-Xantia  
r.o. 0515.K6



## POLEAS DE CIGUEÑAL CITROËN/PEUGEOT



**2848**      Ø 142 mm - 5 canales  
PSA motores XUD7 hasta '96 C15-205  
(reemplaza la polea de 4 canales)  
r.o.0515.K9



**2926**      Ø 152 mm - 6 canales  
PSA 1.9Diesel y TurboD motor XUD  
PSA 1.7Diesel desde '96  
(salvo Jumper-Boxer), r.o.0515.G3



**2927**      Ø 153 mm - 6 canales  
PSA 1.9Diesel motor DW8 hasta '04  
r.o.0515.L7-0515.Q6



**4610**      Ø 155 mm - 6 canales  
PSA 1.9Diesel motor DW8 desde '04  
r.o.0515.R5



**2958**      Ø 143 mm - 5 canales  
PSA 1.5Diesel motor TUD5  
AX-SAXO-106  
r.o.0515.L6



**2928**      Ø 153 mm - 6 canales  
PSA 2.0/2.2HDi motor DW10 (8v) hasta '04  
206-306-307-406-Jumpy-Expert-Boxer, etc.  
r.o.0515.P2-0515.L9



**4441**      Ø 153 mm - 6 canales  
PSA 1.4/1.6HDi motores DV4-DV6  
206-307-407-C2-C3  
r.o.0515.T0-0515.R0-0515.P1



**4411**      Ø 146 mm - 5 canales  
PSA 2.1D y TD motor XUD11 hasta '94  
Xantia-605-XM  
r.o.0515.F8



**2976**      Ø 153 mm - 6 canales  
PSA 2.1D y TD desde '94  
Xantia-605-XM  
r.o.0515.J9



**4201**      Ø 147 mm - 6 canales  
PSA 2.5D y TD motores DJ5 y DJ5T  
Jumper-Boxer  
r.o.0515.H3



**4203**      Ø 153 mm - 6 canales  
Jumper-Boxer 1.9D hasta '96  
XM-605 Diesel Turbo DK5T  
r.o.0515.H7



**4202**      Ø 153 mm - 6 canales  
Jumper-Boxer 1.9D desde '96  
r.o.0515.K4



**4568**      Ø 146 mm - 5+6 canales  
PSA motor 2.8HDi  
Jumper-Boxer  
r.o.0515.P3-0515.N5

## POLEAS DE CIGUEÑAL CITROËN/PEUGEOT - FIAT/ALFA/IVECO



**4477** Ø 152 mm - 6 canales  
PSA 2.0/2.2Hdi motor DW10 (8v) desde '04-  
salvo Jumper-Boxer  
r.o. 0515.S4-0515.R9-0515.R2



**4798** Ø 153 mm - 6 canales  
PSA 2.0Hdi motor DW10 (8v) desde '04-  
Jumper-Boxer  
r.o. 0515.S8-0515.Q0



**4738** Ø 157 mm - 6 canales  
PSA 2.0Hdi-16v motor DW10BTED4  
307-407-C4-C5  
r.o. 0515.Q8

## FIAT - ALFA - LANCIA - IVECO

(FIAT SCUDO: ver Citroën/Peugeot Jumpy-Expert-806-Evasion)



**4308** Ø 170 mm - 6 canales  
1.9 Diesel y JTD  
r.o. 055185409



**4719** Ø 159 mm - 6 canales  
1.3 Diesel  
NPanda-Idea-Punto  
r.o. 4681947



**5041** Ø 145/165 mm - 4+6 canales  
1.3 Diesel JTD  
New Dobló '04-  
r.o. 55182506



**4202** Ø 153 mm - 6 canales  
DUCATO 1.9 Diesel con motor PSA  
r.o. 0515.K4



**4798** Ø 153 mm - 6 canales  
DUCATO 2.0Hdi motor PSA desde '04-  
r.o.



**5042** Ø 144/165 mm - 4+7 canales  
DUCATO 2.3 JTD  
IVECO 2.3 Daily Unijet  
r.o. 504012367



**4568** Ø 146 mm - 5+6 canales  
DUCATO 2.8Hdi  
IVECO 2.8 Daily Unijet  
r.o. 500332293



## POLEAS DE CIGUEÑAL FORD



**4290** Ø 162 mm - 6 canales  
1.9 Diesel-TurboD-TDi hasta '99  
Galaxy  
r.o.



**4421** Ø 143 mm - 6 canales  
1.9 TDi desde '99-  
Galaxy  
r.o. 1315782



**4405** Ø 143 mm - 6 canales  
1.8-2.0 gasolina (motor VAG)  
Galaxy  
r.o.



**4441** Ø 153 mm - 6 canales  
1.4 Diesel TdCi (motor PSA)  
Fiesta '02 - Fusion - Focus '03-  
r.o. 1319519



**4639** Ø 140/154 mm - 6 canales  
1.8 Diesel Lynx  
Connect-Tourneo  
r.o. 1151392



**4815** Ø 145 mm - 5 canales  
1.8 Diesel Kent  
Escort '91-'95-'98  
r.o. 1121216



**4819** Ø 134 mm - 5+5 canales  
1.8 Diesel Kent  
Mondeo-II '93-'97  
r.o. 6767897



**4820** Ø 120 mm - 3+3 canales  
1.8 Diesel Kent Fiesta '89-  
Escort '86-'91-'95/Sierra '87-/Mondeo '93-  
r.o. 6186296

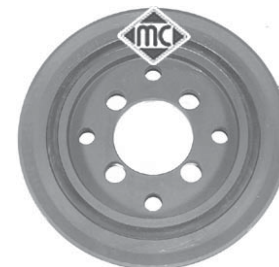

**4838** Ø 135 mm - 5 canales  
1.8 Diesel Kent  
Fiesta '96-  
r.o. 1005817



**4853** Ø 141 mm - 5 canales  
1.8 Diesel Kent  
Fiesta '96 desde 4/'99  
r.o. 1085938



**4818** Ø 146 mm - 6 canales  
1.8 Diesel Lynx  
Fiesta '96 desde 8/'99- / Focus  
r.o. 1100051-1198049



**4814** Ø 164 mm - 6 canales  
2.0 Diesel Duratorq  
Transit '00-75/85CV  
r.o. 1124891



**4816** Ø 164 mm - 6 canales  
2.0 Diesel Duratorq  
Transit '00-100CV/Mondeo-III 130 CV  
r.o. 1124891



**4839** Ø 165 mm - 7 canales  
2.4 Diesel Duratorq  
Transit '00-  
r.o. 1329202



**4821** Ø 163/141 mm - 4+6 canales  
2.5 Diesel  
Transit '95- con a/c  
r.o. 1050620

## POLEAS DE CIGUEÑAL FORD - MERCEDES BENZ



**4837** Ø 152/141 mm - 1+4 canales  
2.5 Diesel  
Transit '95- sin a/c  
r.o. 1050619



**4847** Ø 127 mm - 6 canales  
1.25/1.4/1.6 Zetec S  
Fiesta '96-  
r.o. 1087320



**4848** Ø 138/84 mm - 6+5 canales  
1.4 gasolina  
Fiesta '02-  
r.o. 1141497



**4852** Ø 138 mm - 6 canales  
1.4-1.6 Zetec S  
Focus  
r.o. 1087321



**4817** Ø 132 mm - 6 canales  
1.8-2.0 Zetec E  
Galaxy-Focus  
r.o. 1135052

## MERCEDES BENZ



**4667** Ø 150 mm - 5 canales  
Clase A CDi  
r.o. 1660300303



**4924** Ø 151 mm - 6 canales  
Clase C / E / S gasolina y Diesel  
r.o. 1120351300 - 1120351400

# POLEAS DE CIGUEÑAL NISSAN - OPEL

## NISSAN



**4455** Ø 151/155 mm - 6 canales  
1.9 Diesel - Dti  
Primastar  
r.o.



**4666** Ø 152/155 mm - 7 canales  
1.9 Diesel DTi  
Primastar  
r.o.



**4463** Ø 151/165 mm - 6 canales  
2.2 Diesel DTi  
Primastar - Interstar  
r.o.



**4585** Ø 151/165 mm - 7 canales  
2.2 Diesel DTi  
Primastar - Interstar  
r.o.



**4568** Ø 146 mm - 5+6 canales  
2.8 Diesel  
Interstar  
r.o.



**4464** Ø 151/155 mm - 6 canales  
2.0 gasolina  
Primastar  
r.o.



**4611** Ø 151/155 mm - 7 canales  
2.0 gasolina  
Primastar  
r.o.



**4736** Ø 123 mm - 6 canales  
2.0 gasolina  
Primastar  
r.o.

## OPEL



**4491** Ø 174 mm - 6 canales  
Vectra 2.2D-TD  
r.o. 5614437-5614415-614411



**4718** Ø 153 mm - 5 canales  
Astra / Vectra  
motores 2.0 gasolina X20/Z20  
r.o. 5614438



**4719** Ø 159 mm - 6 canales  
Agila - Corsa C  
motores 1.3 Diesel  
r.o. 5614438



## POLEAS DE CIGUEÑAL OPEL



**4455** Ø 151/155 mm - 6 canales  
1.9 Diesel - DTi  
Vivaro - Movano  
r.o.



**4666** Ø 152/155 mm - 7 canales  
1.9 Diesel DTi  
Vivaro - Movano  
r.o.



**4463** Ø 151/165 mm - 6 canales  
2.2 Diesel DTi  
Vivaro - Movano  
r.o.



**4585** Ø 151/165 mm - 7 canales  
2.2 Diesel DTi  
Vivaro - Movano  
r.o.



**4568** Ø 146 mm - 5+6 canales  
2.8 Diesel  
Movano  
r.o. 4403106



**4464** Ø 151/155 mm - 6 canales  
2.0 gasolina  
Vivaro - Movano  
r.o.



**4611** Ø 151/155 mm - 7 canales  
2.0 gasolina  
Vivaro - Movano  
r.o.



**4736** Ø 123 mm - 6 canales  
2.0 gasolina  
Vivaro - Movano  
r.o.



**4781** Ø 140 mm - 6 canales  
2.0 gasolina  
Vectra B - Vectra C  
r.o. 614654



**4782** Ø 139 mm - 3 canales  
1.5 Diesel / 1.7 Diesel y Turbo (ISUZU)  
Astra F - Corsa B - Vectra A/B  
r.o. 5614417



**4856** Ø 149 mm - 6 canales  
1.7 Diesel y TurboD  
Astra G - Zafira hasta '03  
r.o. 5614441



**4857** Ø 141 mm - 6 canales  
1.7 Diesel y TurboD  
Astra G - Zafira desde '03  
r.o. 5614444

## POLEAS DE CIGUEÑAL RENAULT



**4162** Ø 155 mm - 5 canales  
motor 1.5Dci K9K  
Clio-II/III Kangoo Megane-II  
r.o. 8200051194-8200185800



**4735** Ø 150/155 mm - 6 canales  
motor 1.5Dci K9K  
Clio-II/III Kangoo Megane-II  
r.o. 8200477938-8200552236

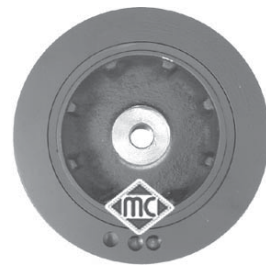

**2849** Ø 132 mm - 6 canales  
motor 1.9Diesel F8Q  
Megane-Express-19-Clio-Kangoo  
r.o. 7700112499-8200386445



**4664** Ø 132 mm - 6 canales  
motor 1.9 TurboDiesel F8Q  
19 - Megane - Scénic  
r.o. 7700856673



**4163** Ø 132 mm - 6 canales  
motor 1.9 Diesel F9Q  
Clio-Megane-Kangoo-Laguna  
r.o. 7700115309



**4455** Ø 151/155 mm - 6 canales  
motor 1.9 Diesel-DTi F9Q  
Trafic II - Laguna-II  
r.o. 7700115766-8200079183-7700113766



**4666** Ø 152/155 mm - 7 canales  
motor 1.9 Diesel F9Q  
Espace IV - Laguna  
r.o. 8200297937-8200457779



**4734** Ø 152/155 mm - 7 canales  
motor 1.9 Diesel F9Q  
Megane-II  
r.o. 8200457775-8200523072



**2850** Ø 118/142 mm - 2 canales  
motor 2.1 Diesel J8S  
21 - Trafic - Master - Espace-I  
r.o. 7700853470



**2851** Ø 137 mm - 6 canales  
motor 2.2 Diesel G8T  
Laguna-I - Trafic - Espace-II - Safrane  
r.o. 7700858731



**4489** Ø 137/140 mm - 6 canales  
motor 2.2 Diesel G8T  
Laguna-I - Trafic - Espace-II - Safrane  
r.o. 7700104292-7700863813-7700100883



**4585** Ø 151/165 mm - 7 canales  
motor 2.2 Diesel G9T  
Espace III - IV  
r.o. 8200458171-8200207435



**4463** Ø 151/165 mm - 6 canales  
motor 2.2 Diesel DTi G9T  
Trafic-II - Laguna-II  
r.o. 8200468081-8200213058

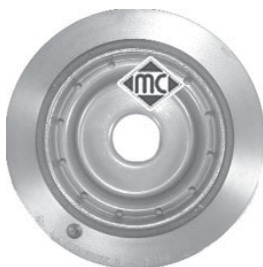

**4465** Ø 133 mm - 6 canales  
motores K4J 1.4/16v y K4M 1.6/16v  
Clio-II - Kangoo - Megane - Laguna-II  
r.o. 8200313231-8200544135-8200392683



**4464** Ø 151/155 mm - 6 canales  
motores F4P 1.8/16v - F4R 2.0/16v  
Trafic-II - Laguna-II  
r.o. 8200451065-8200276838

## POLEAS DE CIGUEÑAL RENAULT - SUZUKI



**4577** Ø 122 mm - 6 canales  
motor F3R 2.0 gasolina 8 válvulas  
Laguna I - Espace III - Megane - Scénic  
r.o. 8200458960-7700109260



**4611** Ø 151/155 mm - 7 canales  
motor F4R 2.0/16v  
Laguna-II - Espace-IV - Megane-II  
r.o. 8200451073-8200276840-8200297935



**4736** Ø 123 mm - 6 canales  
motor F4R 2.0/16v  
Clio-II  
r.o. 8200386460



**4774** Ø 122 mm - 5 canales  
motores F4P 1.8/16v - F4R 2.0/16v  
Laguna I - Espace III - Megane - Scénic  
r.o. 8200386453-8200072415-7700108401

## SUZUKI



**4716** Ø 152 mm - 6 canales  
motor 1.9 Diesel XUD9  
Vitara-Grand Vitara  
r.o.



**2928** Ø 153 mm - 6 canales  
motor 2.0 HDi Diesel DW10  
Vitara-Grand Vitara  
r.o.



**4719** Ø 159 mm - 6 canales  
motor 1.3 Diesel  
Ignis - Wagon - Swift  
r.o.



## POLEAS DE CIGUEÑAL VOLKSWAGEN-SEAT-AUDI-SKODA (VAG)



**4405** Ø 143 mm - 6 canales  
motores 1.8 - 2.0 gasolina  
Toledo 2-Leon-Golf 4/5-A3-Octavia-Ibiza  
r.o. 06A105243E-06A105243F



**4492** Ø 143 mm - 6 canales  
motores 1.2TDi - 1.4TDi  
Lupo-Arosa-Fabia-A2  
r.o. 045105243B-045105243



**4421** Ø 143 mm - 6 canales  
motores 1.9SDi-1.9TDi hasta '02  
Toledo 2-Leon-Golf 4-A3-Octavia-Ibiza  
r.o. 038105243-038105243K



**4495** Ø 160 mm - 5 canales  
motor 1.7SDi  
Polo-95 - Lupo - Arosa  
r.o. 028105243AC



**4290** Ø 162 mm - 6 canales  
motores 1.9D-1.9TD-1.9TDi hasta '98  
Inca-Ibiza-Toledo-Golf 3-Transporter  
r.o. 028105243T



**4494** Ø 143 mm - 6 canales  
motores 1.9SDi-1.9TDi  
Toledo 2-Leon-Golf 4-A3-Octavia-Ibiza  
Polo '03-Fabia, r.o. 038105243M-038105243L



**4497** Ø 143 mm - 4+5 canales  
motor 1.9TDi  
Skoda Superb-Audi A4-A6  
r.o. 038105243F



**4498** Ø 143 mm - 4+5 canales  
motor 1.9TDi  
VW Passat - A4  
r.o. 028105243Q



**4480** Ø 143 mm - 6 canales  
motores 1.9TDi-2.0TDi desde '02-  
Toledo 2-Leon-Golf 4/5-A3-Octavia-Ibiza  
Audi A3-A4-A6, r.o. 03G105243



**4496** Ø 143 mm - 4+5 canales  
motor 2.0TDi  
Golf 4/5 - Skoda Superb - A4 - A6  
r.o. 03G105243B

## POLEAS DE ALTERNADOR



**4894**  
**FIAT-ALFA, flexible**  
 PUNTO '99 - MULTIPLA - MAREA '98-  
 BRAVO-BRAVA  
 r.o.



**5001**       $\varnothing$  65,5 mm - 6 canales  
**FIAT-ALFA, de rueda libre**  
 PUNTO '99 - MULTIPLA - MAREA '98-  
 BRAVO-BRAVA  
 r.o.

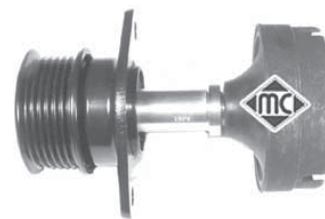

**4887**  
**FORD, sólida con soporte elástico**  
 FIESTA '96 1.8D  
 FOCUS '04- 1.8D de 75 y 90CV  
 r.o. 1334133-1079392



**4752**  
**FORD, de rueda libre con soporte elástico**  
 CONNECT 1.8D  
 FOCUS 1.8D de 100 y 115CV  
 r.o. 1151207-1133969-1423796



**5004**       $\varnothing$  61/55 mm - 6 canales  
**MERCEDES BENZ, de rueda libre**  
 SPRINTER-VITO  
 Clase E/C/G/S W202/W210  
 r.o. 6041500360-6041500060

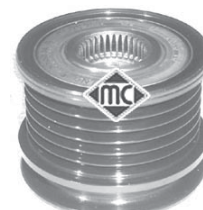

**5005**       $\varnothing$  53/50 mm - 6 canales  
**MERCEDES BENZ, de rueda libre**  
 SPRINTER/VITO  
 Clase E/C/V (motores CDi desde '97-)  
 r.o. 6111500160



**5006**       $\varnothing$  61/55 mm - 6 canales  
**MERCEDES BENZ, de rueda libre**  
 VITO-SPRINTER  
 Clase E/C/V W202/W210  
 r.o. 6041500160-6041150560



**5008**       $\varnothing$  50/50 mm - 5 canales  
**MERCEDES BENZ, de rueda libre**  
 Clase A  
 Vaneo  
 r.o. 6681550615-6401500160



**4915**       $\varnothing$  54,6 mm - 6 canales  
**PEUGEOT-CITROEN, de rueda libre**  
 motores 1.9DW8  
 motores 2.0HDi y 2.2HDi  
 r.o.



**4916**       $\varnothing$  58,5 mm - 6 canales  
**PEUGEOT-CITROEN, de rueda libre**  
 motores 2.0HDi y 2.2HDi  
 r.o.

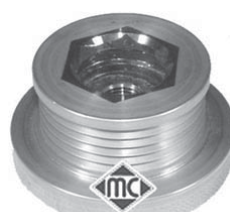

**4728**      5 canales  
**RENAULT, sólida**  
 motores 1.9D (F9Q) y 1.5D (K9K)  
 r.o.



**4729**      6 canales  
**RENAULT, sólida**  
 motores de gasolina 1.4/16v - 1.6/16v  
 r.o.



**4947**      5 canales  
**RENAULT, desembragable**  
 motores 1.9D (F9Q) y 1.5D (K9K)  
 r.o. 8200113636



**4948**      6 canales  
**RENAULT, desembragable**  
 motores de gasolina 1.4/16v - 1.6/16v  
 r.o. 7700110616



**4912**       $\varnothing$  61 mm - 6 canales  
**RENAULT, de rueda libre**  
 alternador Valeo  
 (F-228.881.2)  
 r.o.



## POLEAS DE ALTERNADOR / DISTRIBUCION



**4913** Ø 53,5 mm - 6 canales  
**RENAULT**, de rueda libre  
 alternadores Valeo  
 (F-229.643.10)  
 r.o.



**4914** Ø 55,5 mm - 5 canales  
**RENAULT**, de rueda libre  
 alternadores Valeo  
 (F-234.637)  
 r.o.



**4919** Ø 61 mm - 6 canales  
**VOLKSWAGEN (VAG)**, de rueda libre  
 motores 1.9TDi desde '96 hasta '01  
 Golf-3/4-Toledo-II-Ibiza '97-Sharan  
 r.o.



**4997** Ø 61/55 mm - 6 canales  
**VOLKSWAGEN (VAG)**, de rueda libre  
 A3-A4-Golf 4-Golf 5-Polo '02-Octavia  
 Ibiza '02-Fabia '02-Lupo-Arosa-Toledo '99-  
 r.o.

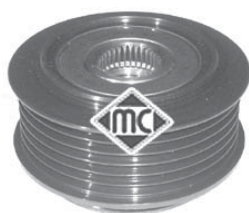

**4998** Ø 73,5/67,5 mm - 6 canales  
**VOLKSWAGEN (VAG)**, de rueda libre  
 Transporter 2.5D  
 LT2.5D  
 r.o.



**4999** Ø 61/55 mm - 6 canales  
**VOLKSWAGEN (VAG)**, de rueda libre  
 Golf 4 - Octavia  
 Sharan-Alhambra  
 r.o.



**5000** Ø 61/56 mm - 5 canales  
**VOLKSWAGEN (VAG)**, de rueda libre  
 motores 1.7D-1.9D/TDi  
 Lupo-Arosa-Polo '95 desde '00-  
 r.o.



**5002** Ø 61/56 mm - 5 canales  
**VOLKSWAGEN (VAG)**, de rueda libre  
 AUDIA4-A6  
 PASSAT '97-  
 r.o.



**5003** Ø 61/56 mm - 5 canales  
**VOLKSWAGEN (VAG)**, de rueda libre  
 AUDIA4-A6  
 PASSAT '97-  
 r.o.



**5007** Ø 61/55 mm - 6 canales  
**VOLKSWAGEN (VAG)**, de rueda libre  
 Ibiza '02-Polo '02-  
 (alternadores Valeo de 70A y 90A)  
 r.o.



**4994**  
**POLEA DE DISTRIBUCION RENAULT**  
 árboles de levas en motores 1.9 D (F9Q)  
 Megane-Clio-Laguna-Trafic-Kangoo, etc.  
 r.o. 7700866844(7700107401)

## BOTELLAS DE EXPANSION BMW - CITROEN - FIAT (ALFA)



**3581**  
BMW (con tapón)



**3595**  
CITROENC15 Diesel



**3545**  
CITROENBERLINGO hasta '02



**3658**  
CITROENBERLINGO/XSARA desde '01-

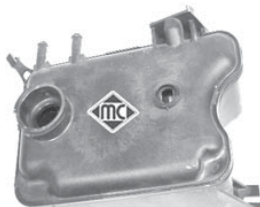

**3643**  
CITROEN AX Diesel - SAXO Diesel



**3653**  
CITROEN XSARA hasta '01

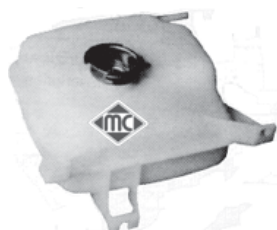

**3526**  
CITROENC25



**3741**  
CITROENJUMPY-EVASION hasta 6/'00



**3742**  
CITROENJUMPY-EVASION desde 6/'00



**3532**  
FIAT UNO Diesel y TurboD '89-'95



**3533**  
FIAT TIPO/TEMPRA Diesel



**3530**  
FIAT PUNTO '93 1.7D/TD

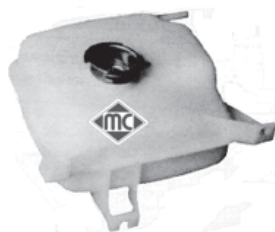

**3526**  
FIAT DUCATO hasta '94



**3743**  
FIAT PALIO gasolina



**3748**  
FIAT PALIO Diesel



**3736**  
FIAT DOBLO



**3741**  
FIAT SCUDO hasta 6/'00



**3742**  
FIAT SCUDO desde 6/'00



**3758**  
FIAT BRAVO-MAREA 1.6/1.8/2.0/1.9D-TD  
ALFA 145-146-156



**3760**  
FIAT PUNTO '93-'99 1.2 con aire acond.



**3759**  
FIAT PUNTO '99-'05 1.8-1.9D/TD

## BOTELLAS DE EXPANSION FORD - MERCEDES - NISSAN



**3508**  
FORD FIESTA '83 a '89



**3509**  
FORD FIESTA '89 a '96



**3576**  
FORD FIESTA '96 a '02



**3703**  
FORD FIESTA '02-/FUSION



**3512**  
FORD ESCORT '86 a '91



**3579**  
FORD ESCORT desde '91-



**3565**  
FORD FOCUS 1.4/1.6



**3744**  
FORD FOCUS 1.8/2.0/1.8D-CONNECT



**3668**  
FORD KA



**3695**  
FORD TRANSIT '95 a '00



**3702**  
FORD TRANSIT '00-

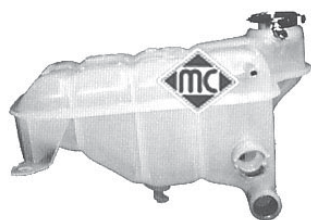

**3613**  
MERCEDES 190/serie 201

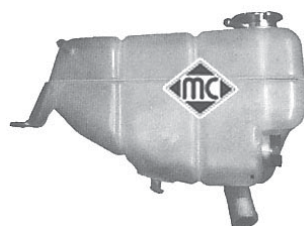

**3622**  
MERCEDES 200-240-300/serie 124



**3746**  
NISSAN MICRA desde '02-



## BOTELLAS DE EXPANSION OPEL - PEUGEOT



**3502**  
OPEL CORSA-A (salvo D-TD)



**3515**  
OPEL CORSA-B



**3732**  
OPEL CORSA-C 1.0-1.2



**3673**  
OPEL CORSA-C 1.3D-1.4-1.6-1.8-1.7D



**3511**  
OPEL KADETT



**3516**  
OPEL ASTRA-F



**3629**  
OPEL ASTRA-G



**3632**  
OPEL VECTRA-A 1.6-1.8-2.0



**3633**  
OPEL VECTRA-A 1.7D-1.7TD



**3630**  
OPEL VECTRA-B



**3643**  
PEUGEOT 106 Diesel



**3501**  
PEUGEOT 205-309 gasolina



**3558**  
PEUGEOT 205 Diesel-309 Diesel



**3656**  
PEUGEOT 206 1.1-1.4-1.6 hasta -11/02



**3657**  
PEUGEOT 206 1.9 Diesel-2.0 HDi



**3653**  
PEUGEOT 306



**3638**  
PEUGEOT 307 (con conectores)



**3654**  
PEUGEOT 406

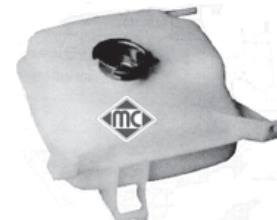

**3526**  
PEUGEOT J5

## BOTELLAS DE EXPANSION PEUGEOT - RENAULT



**3545**  
PEUGEOT PARTNER hasta-'02



**3658**  
PEUGEOT PARTNER desde '02-



**3741**  
PEUGEOT 806-EXPERT hasta -6/'00



**3742**  
PEUGEOT 806-EXPERT desde -6/'00



**3501**  
RENAULT 9-11-12-18



**3500**  
RENAULT 19-21-CLIO-EXPRESS-SUPER5



**3567**  
RENAULT CLIO '98-KANGOO



**3570**  
RENAULT CLIO '98-KANGOO



**3652**  
RENAULT ESPACE-III/IV



**3647**  
RENAULT LAGUNA-I/LAGUNA-II



**3534**  
RENAULT MEGANE-I(-'03)



**3678**  
RENAULT MEGANE-II('03-)



**3664**  
TRAFIC-II('01-)

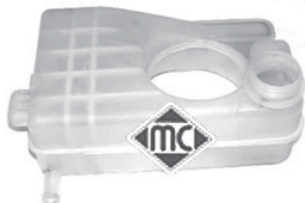

**3564**  
RENAULT TWINGO hasta-'97

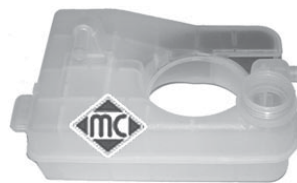

**3671**  
RENAULT TWINGO desde '97-



**BOTELLAS DE EXPANSION SEAT - SKODA - VOLKSWAGEN - AUDI**



**3510**  
SEAT MALAGA - IBIZA (hasta '93)



**3520**  
VOLKSWAGEN GOLF-2 hasta '89



**3504**  
VW GOLF-2/3-IBIZA '93a'02-TOLEDO-I



**3635**  
GOLF/4-TOLEDO-II-LEON-I-OCTAVIA-I  
AUDI A3 hasta '04



**3623**  
VW PASSAT '97-'05  
AUDI A4-A6 (hasta '01)



**3729**  
AUDI A4-A6 (desde '01-)



**3610**  
VW POLO '95 a '02



**3675**  
VW POLO '02-IBIZA '02-SK FABIA '02-



























**3649**  
VW SHARAN - SEAT ALHAMBRA



**3634**  
VW TRANSPORTER '91-'02

## TAPONES DE RADIADOR y BOTELLA DE EXPANSION

 <p><b>3707</b> BMW 1,40 bar</p>	 <p><b>3580</b> BMW 2,00 bar</p>	 <p><b>3572</b> FIAT-ALFA-LANCIA-1,00 bar</p>
 <p><b>3740</b> FIAT-ALFA-LANCIA-1,00 bar</p>	 <p><b>3561</b> FORD 1,20 bar (todos mods. salvo Galaxy)</p>	 <p><b>3650</b> FORD GALAXY</p>
 <p><b>3701</b> FORD TRANSIT '95-'00</p>	 <p><b>3660</b> MERCEDES BENZ 1,40 bar</p>	 <p><b>3507</b> OPEL (todos) 1,20 bar</p>
 <p><b>3560</b> PEUGEOT-CITROEN 1,00 bar</p>	 <p><b>3547</b> PEUGEOT-CITROEN 1,40 bar</p>	 <p><b>3548</b> PEUGEOT-CITROEN 1,40 bar</p>
 <p><b>3519</b> RENAULT 0,70 bar (cápsula blanca)</p>	 <p><b>3524</b> RENAULT 1,00 bar (cápsula verde)</p>	 <p><b>3514</b> RENAULT 1,20 bar (cápsula marrón)</p>
 <p><b>3525</b> RENAULT 1,40 bar (cápsula celeste)</p>	 <p><b>3692</b> RENAULT R-4/5/6/12/18 (radiador)</p>	
 <p><b>3563</b> RENAULT '98- 1,40 bar</p>	 <p><b>3690</b> SKODA Felicia</p>	 <p><b>3574</b> VOLKSWAGEN GOLF-1/2-POLO (hasta '94)</p>
 <p><b>3506</b> VOLKSWAGEN-SEAT-AUDI-SKODA (rosca Ø 58 mm)</p>	 <p><b>3573</b> VOLKSWAGEN-SEAT-AUDI-SKODA (rosca Ø 63 mm)</p>	 <p><b>3676</b> VOLKSWAGEN LUPO SEAT AROSA</p>

## TAPONES DE RADIADOR y BOTELLA DE EXPANSION



**3677**  
VOLKSWAGEN POLO '02-  
SEAT IBIZA '02- SKODA FABIA '02-



**3730**  
VOLKSWAGEN PASSAT '00-  
AUDI A4 '00- / A6 '00-



**3650**  
VOLKSWAGEN SHARAN  
SEAT ALHAMBRA



**3607**  
UNIVERSAL METALICO 0,70 bar



**3608**  
UNIVERSAL METALICO 1,20 bar



**3584**  
UNIVERSAL METALICO 0,50 bar









































**3609**  
VEHICULOS ASIATICOS 1,10 bar













**3605**  
VEHICULOS ASIATICOS 1,10 bar

## TAPONES DE LLENADO ACEITE MOTOR





  <p><b>3747</b> BMW</p>	  <p><b>3639</b> CITROEN-PEUGEOT 1.1-1.4TU</p>	  <p><b>3642</b> CITR.-PEUG. 1.4/1.6HDI-1.9DW8-2.0HDI</p>
  <p><b>3659</b> CITROEN-PEUGEOT 1.6/16v-1.7EW-2.0EW</p>	  <p><b>3685</b> FIAT 1.3D</p>	  <p><b>2742</b> FIAT UNO-BRAVO-PUNTO</p>
  <p><b>3704</b> FORD 1.8D-Lynx desde '98-</p>	  <p><b>3705</b> FORD 1.8D-Kent- 1.4-1.6-1.8</p>	  <p><b>3734</b> MERCEDES BENZ</p>
  <p><b>3674</b> OPEL X16-X20-Z20-Y17DT-Z17DT-2.0D-2.2D</p>	  <p><b>3682</b> OPEL 1.2/8v-1.4/8v-1.6/8v-1.8/8v-1.7D</p>	  <p><b>3683</b> OPEL 1.5D/TD-1.7D/TD</p>
  <p><b>3684</b> OPEL 1.4/16v- 1.6/16v</p>	  <p><b>3685</b> OPEL 1.3Diesel</p>	
  <p><b>3617</b> RENAULT 1.9D (F9Q)</p>	  <p><b>3619</b> RENAULT 1.4/16v-1.6/16v</p>	  <p><b>3648</b> RENAULT 2.2D (G8T)</p>
  <p><b>3621</b> VOLKSWAGEN-AUDI-SEAT-SKODA</p>	  <p><b>3636</b> VW TRANSPORTER</p>	

## BIELETAS CAMBIO DE VELOCIDADES PEUGEOT - CITROËN

### BIELETAS DE LONGITUD VARIABLE (\*):

		LONGITUD(**)	Ø ROTULAS	CABEZALES
	<b>2407</b>	52 a 67mm	10mm	rígidos
	<b>4602</b>	70 a 90mm	10-13mm	rígidos
	<b>4159</b>	75 a 105mm	13mm	rígidos
	<b>2865</b>	90 a 140mm	10mm	rígido-elástico
	<b>2347</b>	125 a 135mm	10mm	rígidos
	<b>4081</b>	138mm	10mm	rígido-elástico
	<b>2375</b>	175 a 195mm	10mm	rígido-elástico
	<b>2376</b>	175 a 190mm	10mm	rígidos
	<b>2866</b>	240 a 300mm	13mm	rígido-elástico
	<b>2348</b>	280 a 300mm	13mm	rígidos
	<b>4420</b>	230 a 280mm	10-13mm	rígido-elástico

### BIELETAS DE LONGITUD FIJA:







	<b>4200</b>	321mm	13mm	rígido-elástico
	<b>2377</b>	330mm	13mm	rígido-elástico
	<b>2322</b>	740mm	13mm	rígidos
	<b>2323</b>	700mm	13mm	rígidos

(\* con estas referencias es posible -alargando o acortando hasta la medida adecuada- cubrir TODA la gama de bieletas CITROËN - PEUGEOT









(\*\*) importante: la longitud indicada es ENTRE CENTROS

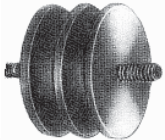
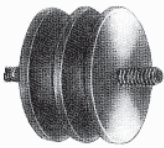
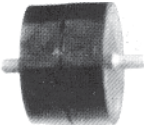
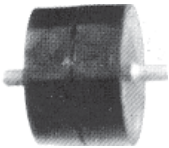

## SILENTBLOCS

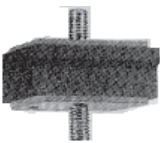
	<b>2823</b> Ø 15 altura 8	altura rosca 10 y 15 (M-5)	
	<b>449</b> Ø 15 altura 16	altura rosca 10 (M-5)	
	<b>4660</b> Ø 16 altura 9	altura rosca 18 (M-6)	
	<b>4490</b> Ø 18 altura 15	altura rosca 13 (M-6)	
	<b>2442</b> Ø 25 altura 22	altura rosca 20 (M-8)	
	<b>153</b> Ø 25 altura 25	altura rosca 12 (M-6)	cintura Ø 17
	<b>2785</b> Ø 30 altura 15	altura rosca 14 (M-8)	
	<b>2777</b> Ø 30 altura 30	altura rosca 20 (M-8)	
	<b>4709</b> Ø 30 altura 40	altura rosca 13 (M-6)	cintura Ø 17
	<b>124</b> Ø 32 altura 18	altura rosca 14 (M-8)	cintura Ø 25
	<b>097</b> Ø 34 altura 25	altura rosca 14 (M-6)	cintura Ø 29
	<b>2473</b> Ø 35 altura 38	altura rosca 18 (M-8)	
	<b>126</b> Ø 36 altura 34	altura rosca 15 (M-8)	cintura Ø 26
	<b>2474</b> Ø 38 altura 20	altura rosca 25 (M-10)	
	<b>167</b> Ø 38 altura 20	altura rosca 25 (M-10)	cintura Ø 27

## SILENTBLOCS y TOPES DE GOMA

	<b>240</b>	Ø 38	altura 20	altura rosca 25	(M-8)	cintura Ø 27
	<b>2487</b>	Ø 50	altura 45	altura rosca 23	(M-10)	
	<b>4809</b>	Ø 50	altura 40	altura rosca 16	(M-8)	cintura Ø 36
	<b>405</b>	Ø 57	altura 36	altura rosca 25	(M-10)	
	<b>404</b>	Ø 63	altura 32	altura rosca 25	(M-10)	
	<b>2475</b>	Ø 63	altura 50	altura rosca 22	(M-10)	
	<b>203</b>	Ø 72	altura 52	altura rosca 25	(M-10)	
	<b>2476</b>	Ø 76	altura 38	altura rosca 22	(M-10)	
	<b>2653</b>	ancho 38	altura 15	altura rosca 18	(M-8)	ent. centros 76 (agujeros) ent. centros 45 (espárragos)
	<b>378</b>	32x45	altura 22	altura rosca 15	(M-8)	
	<b>2962</b>	70x76	altura 51	altura rosca 20	(M-10)	
	<b>2737</b>	Ø 25	altura 27	altura rosca 8	(M-5)	
	<b>2895</b>	Ø 50	altura 52	altura rosca 20	(M-8)	

## VARIOS - BOMBAS DE CEBADO - TAPONES DE GOMA





























 <p><b>409</b> tirante sujeción capó completo, grande</p>	 <p><b>471</b> tirante sujeción capó, sólo goma</p>	 <p><b>103</b> tirante sujeción capó completo, pequeño</p>
 <p><b>4036</b> bomba de cebado manual Diesel. Racores de Ø 8 mm y accesorio en codo a 90°.</p>	 <p><b>4418</b> bomba de cebado para filtros de gasoil tipo LUCAS-ROTO (6 dientes)</p>	 <p><b>4419</b> bomba de cebado para filtros de gasoil tipo PURFLUX (4 dientes)</p>
 <p><b>309</b> funda muelles suspensión</p>	 <p><b>589</b> scapuchón bola de remolque</p>	 <p><b>023</b> kit de ventosas esmerilado válvulas Ø 20 y Ø 28mm</p>
 <p><b>942</b> capuchon protector distribuidor</p>	 <p><b>858</b> tubo pasta de cobre para eliminar ruidos en pastillas de freno</p>	 <p><b>4522</b> pasacables de goma, Ø 10x22, alto 9,5 mm</p>

## TAPONES DE GOMA



























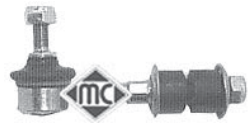

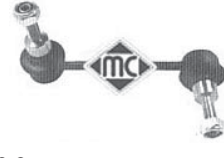

<b>0016</b>	Ø2,5 mm	(retorno de inyectores DIESEL)
<b>4946</b>	Ø 6 mm	
<b>2889</b>	Ø 8 mm	
<b>4416</b>	Ø 10 mm	
<b>2728</b>	Ø 12 mm	
<b>2325</b>	Ø 16 mm	
<b>2326</b>	Ø 19 mm	
<b>2914</b>	Ø 22 mm	
<b>4409</b>	Ø 25 mm	

# BIELETAS PUNTAL BARRA ESTABILIZADORA ALFA/FIAT-AUDI-BMW-FORD















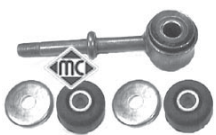













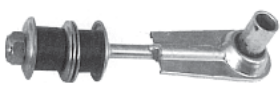

 <p><b>2637</b> ALFA 145-146/FIAT MAREA BRAVO/A TIPO-TEMPRA</p>	 <p><b>2956</b> FIAT DUCATO desde '94</p>	 <p><b>2948</b> FIAT SCUDO</p>	 <p><b>4341</b> FIAT STILO</p>
 <p><b>4338</b> AUDI 80-90-100 desde '91 a '94</p>	 <p><b>4249</b> AUDI A3 (metálica) hasta -'04</p>	 <p><b>4250</b> AUDI A3 (plástico) hasta -'04</p>	 <p><b>4143</b> izquierda AUDI A4 desde '97 - A6</p>
 <p><b>4146</b> derecha AUDI A4 desde '97 - A6</p>	 <p><b>4333</b> izquierda AUDI A4 hasta '97</p>	 <p><b>4334</b> derecha AUDI A4 hasta '97</p>	 <p><b>4874</b> AUDI A3 desde '04-</p>
 <p><b>4339</b> BMW serie 3 de '82 a '91 (E30)</p>	 <p><b>4263</b> BMW serie 3 de '91 a '98 (E36) BMW serie 5 de '87 a '95 (E34)</p>	 <p><b>4341</b> BMW serie 3 desde '98 (E46)</p>	 <p><b>4342</b> izquierda BMW serie 5 desde '95 (E39)</p>
 <p><b>4343</b> derecha BMW serie 5 desde '95 (E39)</p>			
 <p><b>4263</b> FORD FIESTA '89 (salvo 1.8D) FIESTA '96-ESCORT '91-'98</p>	 <p><b>4264</b> FORD FIESTA '89 1.8 Diesel FORD COURIER 1.8 Diesel</p>	 <p><b>4160</b> FOCUS (reemplaza la de aluminio, anulada en FORD) - CONNECT</p>	 <p><b>4263</b> FORD MONDEO '93 y '97 FORD KA</p>
 <p><b>4855</b> FORD FIESTA '02-FUSION</p>	 <p><b>4900</b> FORD MONDEO '01-</p>	 <p><b>4240</b> FORD TRANSIT '86-'00 izquierda</p>	 <p><b>4281</b> FORD TRANSIT '86-'00 derecha</p>
 <p><b>4886</b> FORD TRANSIT '00-</p>	 <p><b>4235</b> FORD MONDEO '93- trasera</p>	 <p><b>4236</b> FORD MONDEO '97- trasera</p>	 <p><b>4901</b> FORD MONDEO '01- trasera</p>

# BIELETAS PUNTAL BARRA ESTABILIZADORA MERCEDES-NISSAN-OPEL-PSA

 <p><b>4885</b> FORD FOCUS trasera</p>	 <p><b>4261</b> FORD GALAXY</p>		
 <p><b>5030</b> MERCEDES Clase A</p>	 <p><b>5025</b> trasera MERCEDES 190-124-Class C/E</p>	 <p><b>5018</b> tirante trasero MERCEDES W201-W124-W210</p>	 <p><b>5040</b> MERCEDES VITO trasera</p>
 <p><b>5027</b> delt. izquierda MERCEDES Clase E (W210)</p>	 <p><b>5026</b> delt. derecha MERCEDES Clase E (W210)</p>	 <p><b>4402</b> delt. izquierda MERCEDES VITO</p>	 <p><b>4403</b> delt. derecha MERCEDES VITO</p>
 <p><b>5059</b> delt. izquierda MERCEDES SPRINTER '01</p>	 <p><b>5058</b> delt. derecha MERCEDES SPRINTER '01</p>	 <p><b>5061</b> delt. izquierda MERCEDES SPRINTER '01-</p>	 <p><b>5060</b> delt. derecha MERCEDES SPRINTER '01-</p>
 <p><b>4344</b> NISSAN MICRA</p>	 <p><b>4457</b> NISSAN PRIMASTAR</p>	 <p><b>4237</b> NISSAN TERRANO-2</p>	 <p><b>4706</b> NISSAN TERRANO-2 trasera</p>
 <p><b>4399</b> izquierda NISSAN INTERSTAR OPEL MOVANO</p>	 <p><b>4400</b> derecha NISSAN INTERSTAR OPEL MOVANO</p>	 <p><b>4241</b> OPEL VECTRA-B OPEL CORSA C</p>	 <p><b>4977</b> OPEL VECTRA-C</p>
 <p><b>2628</b> barra Ø 22 mm ASTRA-F hasta '95 VECTRA-A/CALIBRA hasta '95</p>	 <p><b>2629</b> barra Ø 18 mm ASTRA-F hasta '95 VECTRA-A/CALIBRA hasta '95</p>	 <p><b>4282</b> ASTRA-F desde '95 VECTRA-A desde '95</p>	 <p><b>4242</b> ASTRA-G ZAFIRA</p>
 <p><b>4332</b> CITROEN AX-GT1 PEUGEOT 106 1.6 VTS</p>	 <p><b>2693</b> CITROEN ZX hasta '93</p>	 <p><b>2937</b> ZX desde '93-XSARA-BERLINGO PEUGEOT PARTNER</p>	 <p><b>4398</b> CITROEN BX</p>

















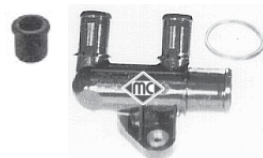







## BIELETAS PUNTAL BARRA ESTABILIZADORA PSA - RENAULT

 <p><b>5055</b> CITROEN EVASION '02- PEUGEOT 807</p>	 <p><b>4959</b> CITROEN XM PEUGEOT 605</p>	 <p><b>4960</b> trasera izquierda CITROEN XM PEUGEOT 605</p>	 <p><b>4961</b> trasera derecha CITROEN XM PEUGEOT 605</p>
 <p><b>2956</b> CITROEN JUMPER PEUGEOT BOXER</p>	 <p><b>2948</b> CITROEN JUMPY-EVASION PEUGEOT EXPERT-806</p>	 <p><b>2968</b> rosca M-12 CITROEN SAXO 1.6VTS-XANTIA PEUGEOT 406 hasta PR7664</p>	 <p><b>4067</b> rosca M-10 CITROEN XANTIA</p>
 <p><b>4035</b> PEUGEOT 205 1.3 Rallye PEUGEOT 205 1.9 GTI</p>	 <p><b>4068</b> PEUGEOT 206 CITROEN C2/C3</p>	 <p><b>4053</b> PEUGEOT 306</p>	 <p><b>2874</b> PEUGEOT 405</p>
 <p><b>4046</b> PEUGEOT 406 desde PR7665 CITROEN C5</p>	 <p><b>4056</b> PEUGEOT 406 trasera</p>	 <p><b>4331</b> PEUGEOT 406 trasera (mangueta)</p>	 <p><b>4401</b> PEUGEOT 307</p>
 <p><b>4801</b> izquierda PEUGEOT 407</p>	 <p><b>4802</b> derecha PEUGEOT 407</p>	 <p><b>4803</b> PEUGEOT 407 trasera</p>	
 <p><b>178</b> RENAULT 12 -18 (hasta '82)</p>	 <p><b>495</b> RENAULT 18 (desde '82)</p>	 <p><b>2655</b> CLIO-I/CLIO-II/KANGOO</p>	 <p><b>4574</b> RENAULT ESPACE-II</p>
 <p><b>4243</b> RENAULT LAGUNA-I SAFRANE - ESPACE-III</p>	 <p><b>4457</b> RENAULT LAGUNA-II ESPACE-IV - TRAFIC '01-</p>	 <p><b>4221</b> RENAULT SCENIC 4x4</p>	 <p><b>4628</b> RENAULT MEGANE-II '03-</p>
 <p><b>4399</b> izquierda RENAULT MASTER '98-</p>	 <p><b>4400</b> derecha RENAULT MASTER '98-</p>	 <p><b>4674</b> izquierda RENAULT TWINGO DESDE '00-</p>	 <p><b>4673</b> derecha RENAULT TWINGO DESDE '00-</p>













# BIELETAS PUNTAL BARRA ESTABILIZADORA SEAT-SKODA-VOLKSWAGEN

 <p><b>646</b> TOLEDO hasta '95 / GOLF-2 IBIZA hasta '94 / GOLF-3</p>	 <p><b>2852</b> IBIZA desde '94 TOLEDO desde '95 hasta '99</p>	 <p><b>2853</b> VW POLO '95 - AROSA - LUPO VW POLO 2000</p>	 <p><b>4336</b> TOLEDO 2.0-16v hasta '99 GOLF-3 2.0 y 2.8</p>
 <p><b>4249</b> (metálica) TOLEDO '99 - OCTAVIA LEON - VW GOLF 4</p>	 <p><b>4250</b> (plástico) TOLEDO '99 - OCTAVIA LEON - VW GOLF 4</p>	 <p><b>4345</b> VW PASSAT de '88 a '96 para barra de Ø 21 mm</p>	 <p><b>4142</b> VW PASSAT de '88 a '96 para barra de Ø 23 mm</p>
 <p><b>4143</b> izquierda VW PASSAT desde '97</p>	 <p><b>4146</b> derecha VW PASSAT desde '97</p>	 <p><b>4314</b> VW TRANSPORTER hasta '96</p>	 <p><b>4335</b> VW TRANSPORTER desde '96</p>
 <p><b>4261</b> VW SHARAN SEAT ALHAMBRA</p>	 <p><b>4792</b> VW POLO '02 - IBIZA '02 - SK FABIA '02 -</p>	 <p><b>4874</b> VW GOLF 5 - SK OCTAVIA-II SEAT TOLEDO '04 - ALTEA</p>	 <p><b>4967</b> trasera VW GOLF 5 - SK OCTAVIA-II SEAT TOLEDO '04 - ALTEA</p>

## BRIDAS DE AGUA BMW - PSA - FORD - OPEL - VAG

<p><b>¡Nuevo!</b></p>  <p><b>3749</b> BMW r.o.11531722531</p>	<p><b>¡Nuevo!</b></p>  <p><b>3640</b> PSA motores TU5J 1.6 gasolina r.o.1201.C3</p>	<p><b>¡Nuevo!</b></p>  <p><b>3641</b> PSA motores TU1-TU3 desde '00- r.o.1201.C2</p>
 <p><b>3503</b> PSA motores Diesel y TD XUD9-XUD9TE r.o.1336.G4</p>	 <p><b>3523</b> PSA motores XU gasolina r.o.1336.H7-1336.J7</p>	 <p><b>3544</b> PSA motores 1.9D-DW8 y 2.0HDi-DW10 r.o.1336.P3-1336.Q3</p>
 <p><b>3554</b> XSARA-206-406 motor 2.0HDi r.o.1336.P5</p>	 <p><b>3555</b> XSARA-206 motor 1.9DW8 r.o.1336.N8</p>	 <p><b>3578</b> PSA tapa bomba agua motores TU hasta '98 (con junta tórica), r.o.1201.6</p>
<p><b>¡Nuevo!</b></p>  <p><b>4844</b> FORD motores Zetec 1.4/1.6 r.o.1301722-1221325</p>	<p><b>¡Nuevo!</b></p>  <p><b>4693</b> OPEL motores ISUZU 1.5D/TD-1.7D r.o.606406</p>	<p><b>¡Nuevo!</b></p>  <p><b>4713</b> OPEL motores ISUZU 1.7D/TD r.o.1338323</p>
<p><b>¡Nuevo!</b></p>  <p><b>3662</b> RENAULT motores 1.9D F8Q y F9Q r.o.7700873948</p>	<p><b>¡Nuevo!</b></p>  <p><b>3665</b> RENAULT motores 1.9D F8Q y F9Q r.o.7700101034</p>	
 <p><b>3505</b> GOLF-2 1.8/Passat '88 1.8 r.o.037121133C</p>	 <p><b>3535</b> TOLEDO 1.6-1.8-2.0/Golf-2 1.6 r.o.037121133B-037121132B</p>	 <p><b>3522</b> IBIZA '93 1.6-1.8-2.0/GOLF-3 1.8-2.0 r.o.037121133F/037121132E/037121132G</p>
 <p><b>3517</b> GOLF-2/3/IBIZA/TOLEDO/AUDI r.o.026121145E-037121145</p>	 <p><b>3527</b> IBIZA/GOLF-3/TOLEDO 1.9D-1.9TD r.o.068121133AB/AE</p>	 <p><b>3542</b> IBIZA-GOLF-TOLEDO-PASSAT 1.9TDI r.o.028121132A(028121132)</p>
 <p><b>3543</b> POLO-IBIZA 1.4-1.6/GOLF2-3 r.o.030121117L-030121117M</p>	 <p><b>3614</b> POLO '95 1.9Diesel r.o.028121132B</p>	 <p><b>3585</b> AROSA-LUPO-POLO'95 1.7Diesel r.o.028121132C</p>

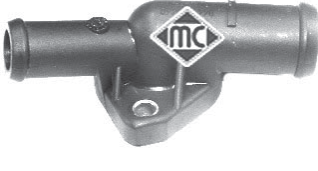
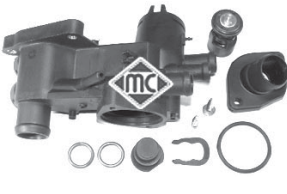
## BRIDAS DE AGUA VAG

 <p><b>3566</b> VW PASSAT '97 1.8- AUDIA4-A6 1.8 r.o.058121132-058121133B</p>	 <p><b>3582</b> TOLEDO-GOLF-32.0 r.o.028121133E</p>	 <p><b>3583</b> IBIZA-TOLEDO-GOLF-21.8 r.o.027121145B</p>
 <p><b>3586</b> AUDI80 1.9D '90-'95 r.o.028121144M-028121145C</p>	 <p><b>3587</b> PASSAT 1.9D-A4 1.9D-AUDI80 '89-'91 r.o.028121144N-028121145G</p>	 <p><b>3589</b> IBIZA-TOLEDO 1.6-GOLF-4 1.6 r.o.037121145F-037121144H</p>
 <p><b>3591</b> GOLF-4 1.9TDi '99, AUDIA3 1.9TDi VW SHARAN 1.9TDi, r.o.</p>	 <p><b>3594</b> AUDI80 1.9D '91-'95 r.o.048121145B</p>	 <p><b>3596</b> AUDIA4 1.6- PASSAT '97 1.6 r.o.050121133C-050121132A</p>
 <p><b>3598</b> AUDIA3 1.6-1.9- GOLF-4 OCTAVIA-LEON r.o.06A121132</p>	 <p><b>3599</b> AUDIA3 1.8-GOLF-4 1.8-OCTAVIA 1.8 r.o.06A121132Q</p>	 <p><b>3600</b> IBIZA '99-TOLEDO '99 1.8-GOLF-4 1.8 r.o.06A121132A-06A121132G/D</p>
 <p><b>3601</b> PASSAT 1.6-2.0 AUDIA4 1.6-1.8-A6 1.8 r.o.06B121121</p>	 <p><b>3602</b> VW TRANSPORTER 2.5D '90-'95 r.o.074121132</p>	 <p><b>3603</b> VW TRANSPORTER 2.5D '90-'95 r.o.074121143D</p>
 <p><b>3612</b> VW TRANSPORTER 1.9D-TD r.o.044121144B</p>	 <p><b>3615</b> POLO '95 1.0-1.4-GOLF-3 1.4-1.6-IBIZA cuerpo completo con termostato y tapa</p>	 <p><b>3604</b> TOLEDO '99-LEON-GOLF-4-OCTAVIA conexión completa manguitos radiador</p>
 <p><b>4755</b> VW TRANSPORTER 2.4D-2.5D r.o.074121145B</p>	 <p><b>2110</b>                      <b>19,60 x 3,65 mm</b> junta tórica para sensores en cajas de agua r.o.357121140+032121142+N90316802</p>	 <p><b>3540</b> kit tapón, clip y tórica r.o.</p>















## TAPAS Y CAJAS DE TERMOSTATO FIAT - FORD - OPEL - PSA

<p><b>iNuevo!</b></p>  <p><b>3755</b> con termostato FIAT Punto-I 1.7TD ('93-'99) r.o. 7741883-7741884</p>	<p><b>iNuevo!</b></p>  <p><b>3756</b> con termostato FIAT 1.0-1.1-1.2 gasolina (UNO-Palio-etc.) r.o. 7589135</p>	<p><b>iNuevo!</b></p>  <p><b>3757</b> con termostato FIAT 1.7D/1.9D '89-'97 (Tipo-Bravo-Uno) r.o. 7625346</p>
 <p><b>3114</b> FORD FIESTA '76a'83 r.o. 6028494</p>	 <p><b>3113</b> FORD FIESTA '84a'96 r.o. 6814635</p>	 <p><b>3562</b> FORD motores Zetec hasta '96 r.o. 1052405-6756229</p>
 <p><b>3577</b> FORD FIESTA '96/FOCUS 1.4-1.6 r.o. 1112977</p>	 <p><b>3150</b> FORD FIESTA '96 1.3 hasta '98 r.o. 1002815</p>	 <p><b>3142</b> FORD FIESTA 1.3-KA desde '98 r.o. 1027596</p>
 <p><b>3606</b> FORD motores 1.8 Diesel hasta '96 r.o. 6189058</p>	 <p><b>3151</b> FORD FIESTA 1.8 Diesel desde '96 r.o. 10310904</p>	<p><b>iNuevo!</b></p>  <p><b>4845</b> FORD motores Diesel 1.8D hasta-'03 r.o. 1079905-1131995-6585512</p>
<p><b>iNuevo!</b></p>  <p><b>3709</b> FORD motores 1.3 Rocam-Duratec Fiesta '96 r.o. 1149691+1149620+1313546+1089792</p>	<p><b>iNuevo!</b></p>  <p><b>3713</b> FORD motores 1.8 Diesel-Lynx desde '03- r.o. 1198060+1148329+1086282+1098228</p>	<p><b>iNuevo!</b></p>  <p><b>3716</b> FORD motores 1.3 Fiesta '02- Fusion r.o. 1149691+1089792+1313546</p>
<p><b>iNuevo!</b></p>  <p><b>3712</b> FORD TRANSIT '92y'95 r.o. 1093990+1093991+6193670+1086282</p>	 <p><b>3071</b> OPEL CORSA-KADETT r.o. 1338151</p>	<p><b>iNuevo!</b></p>  <p><b>3162</b> OPEL motores ISUZU 1.5D/TD/1.7D r.o. 1338182-1338188</p>
<p><b>iNuevo!</b></p>  <p><b>4715</b> OPEL motores ISUZU 1.5D/TD/1.7D r.o. 1338192-1338191-1338194</p>	 <p><b>3011</b> PSA motores TU gasolina hasta '97 r.o. 1336.44</p>	 <p><b>3611</b> con termostato PSA motores TU gasolina desde '97 (salvo Peug-206), r.o. 1336.Q2</p>
 <p><b>3539</b> PSA motores 1.9D -TD desde '93 r.o. 1336.C9</p>	 <p><b>3616</b> PSA motores 1.7D (XUD7) r.o. 1336.E8</p>	 <p><b>3538</b> PSA 1.6-1.8-2.0 (XU5-XU7-XU10)d/'93 gasolina, r.o. 1336.A1</p>

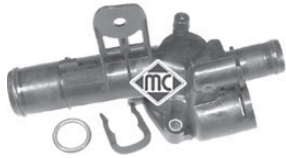

## TAPAS Y CAJAS DE TERMOSTATO PSA - RENAULT

 <p><b>3551</b>      <b>Ø base 56 mm</b> PSA 1.6-1.8-2.0(XU5-XU7-XU10) desde '91 hasta '93 gasolina, r.o. 1336.88</p>	 <p><b>3552</b>      <b>Ø base 53 mm</b> PSA 1.6-1.8-2.0(XU5-XU7-XU10) hasta '91 gasolina, r.o.1336.G1</p>	 <p><b>3550</b> SAXO 1.5D - 1061.5D r.o. 1336.L2- 1336.K2</p>
 <p><b>3132</b> AX 1.4D - 1.5D - 1061.4D-1.5D r.o. 1336.C2</p>	 <p><b>3546</b> JUMPY-EXPERT-DUCATO-BOXER 1.9D r.o. 1336.G3</p>	 <p><b>3556</b> PSA motores 2.0HDi (caja de plástico) r.o. 1336.R9</p>
 <p><b>3135</b> PSA motores 2.0HDi (caja de aluminio) r.o. 1336.P2</p>	 <p><b>3620</b>      <b>con termostato</b> PEUGEOT2061.1-1.4-1.6TU r.o. 1336.Q1-1336.N5</p>	
 <p><b>3116</b> CLIO-EXPRESS-R-19 motores 1.2-1.4 r.o. 7700738110</p>	 <p><b>3117</b> R-9/11/19/EXPRESS/CLIO/21GTS/Super5 motores 1.7-1.8 y Diesel, r.o. 7700851979</p>	 <p><b>3115</b> R-19TXI r.o. 7700726976</p>
 <p><b>3119</b> MEGANE 1.4-1.6-CLIO '98-KANGOO 1.4 r.o. 7700866387</p>	 <p><b>3156</b>      <b>con termostato</b> CLIO '961.2-TWINGO-KANGOO 1.2 hasta 6/'98, r.o. 7700868980</p>	 <p><b>3669</b> RENAULT motores 1.2 gasolina desde 6/'98 r.o. 7700110716</p>
 <p><b>3569</b>      <b>con termostato</b> RENAULT motores 1.9DF8Q (hasta '99) cuerpo completo con tapa, r.o. 7701474249</p>	 <p><b>3624</b>      <b>sin termostato</b> RENAULT motores 1.9DF8Q (hasta '99) cuerpo completo con tapa</p>	 <p><b>3670</b> RENAULT motores 1.5DCi hasta '03 r.o. 8200374994-8200400554</p>
 <p><b>3679</b> RENAULT motores 1.5 DCi desde '03- r.o. 8200267349</p>	 <p><b>3645</b>      <b>89°</b> RENAULT motores 1.9DF9Q desde '99 r.o. 8200074346</p>	 <p><b>3661</b>      <b>83°</b> RENAULT motores 1.9DF9Q desde '99 r.o. 8200074349</p>
 <p><b>3646</b>      <b>83°</b> RENAULT motores 2.2DG9T-2.5DG9U r.o. 8200262237-8200262241-8200154296</p>		

## TAPAS Y CAJAS DE TERMOSTATO SEAT - VAG

 <p><b>3118</b> SEAT IBIZA (hasta '93) - MALAGA r.o. SE-021032200A</p>		
 <p><b>3528</b> POLO-IBIZA 1.05-1.3-1.4/Golf 2 1.05-1.3 GOLF-3 1.4-1.6, r.o. 030121121B</p>	 <p><b>3536</b> GOLF-2 1.6-1.8-D-TD/Toledo Diesel r.o. 055121121F</p>	 <p><b>3537</b> GOLF-3 IBIZA 1.6-1.8-2.0-D-TD-TDi TOLEDOD-TD-TDi, r.o. 037121121A</p>
 <p><b>3541</b> POLO-IBIZA-GOLF-3-INCA-AROSA-LUPO r.o. 032121121J</p>	 <p><b>3592 kit tapa con termostato</b> POLO-IBIZA-GOLF-3-INCA-AROSA-LUPO r.o. 032121121J+032121110B</p>	 <p><b>3588</b> GOLF-3-POLO '95 r.o. 032121121A</p>
 <p><b>3593</b> VW PASSAT '97 1.9D-TDi-AUDIA4-A6 r.o. 048121121B</p>	 <p><b>3597</b> VW GOLF-3/4-TOLEDO'98 1.6-1.8-LEON r.o. 06A121121C</p>	 <p><b>3590</b> VW GOLF-4-TOLEDO'98-LEON 1.9TDi r.o. 038121121</p>
 <p><b>3615</b> POLO '95 1.0-1.4-GOLF-3 1.4-1.6-IBIZA r.o. 032121111N</p>	 <p><b>3693</b> POLO '02-IBIZA '02-FABIA '02-1.4/16V r.o. 032121111AP</p>	 <p><b>3726</b> POLO '02-IBIZA '02-FABIA '02-1.23 cyl. r.o. 03C121111B</p>
 <p><b>3667</b> GOLF-3 IBIZA 1.6-1.8-2.0-D-TD-TDi r.o. 037121619+037121121A</p>	 <p><b>3745</b> TOLEDO-II GOLF-4 A3 OCTAVIA 1.6 r.o. 06A121114</p>	







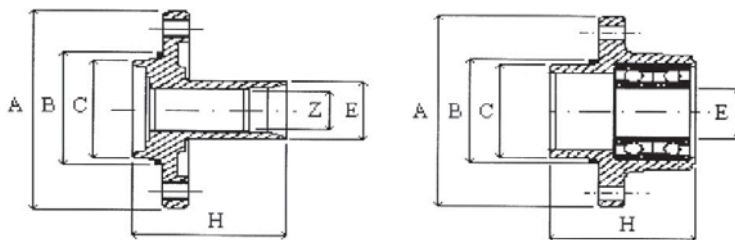



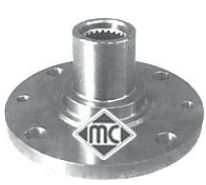

## BUJES DE RUEDA

### indicación de medidas:

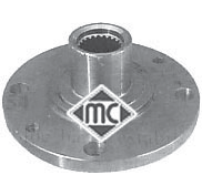
A=DIAMETRO EXTERIOR  
 B=DIAMETRO DEL TAMBOR O DISCO DE FRENO  
 C=DIAMETRO DEL AGUJERO DE LA RUEDA  
 E=DIAMETRO DEL RODAMIENTO  
 H=ALTURA TOTAL  
 Z=NUMERO DE ESTRIAS















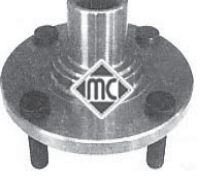
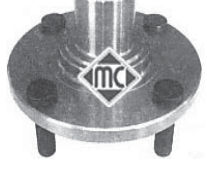

### BMW - FIAT/ALFA/LANCIA

 <p><b>90056</b>                      BMW series 3 y 5                      rueda 4 agujeros  <b>CON RODAMIENTO</b>                      A=120 B=66 C=57                      E=31 H=63                      r.o. 31211131297</p>	 <p><b>90057</b>                      BMW series 3 - 5 y 7                      rueda 5 agujeros  <b>CON RODAMIENTO</b>                      A=139 B=79 C=72,5                      E=37 H=65                      r.o. 31221139345</p>	
 <p><b>90001</b>                      FIAT UNO desde '89                      A=117 B=58 C=58                      E=30 H=78,5 Z=20                      r.o. 4399777</p>	 <p><b>90002</b>                      FIAT Regata - UNO                      hasta '89                      A=117 B=59 C=58                      E=35 H=77,5 Z=22                      r.o. 4390949</p>	 <p><b>90099</b>                      FIAT DOBLO 1.9 JTD                      FIAT PALIO                      A=116 B=59 C=58                      E=37 H=78 Z=26                      r.o. 46745258</p>
 <p><b>90009</b>                      FIAT PANDA                      LANCIA Y10                      A=117 B=59 C=58                      H=70 Z=20                      r.o. 4900918</p>	 <p><b>90010</b>                      FIAT PUNTO '99 1.8                      BRAVO.A/ TIPO 1.9 TD                      ALFA 145-146 salvo                      A=116 B=59 C=58                      E=37 H=71,5 Z=25                      r.o. 7667265</p>	 <p><b>90016</b>                      PUNTO '93 1.1-1.2-1.9D                      PUNTO '99 1.2-1.9D/JTD                      BRAVO 1.4-1.6-1.8                      TIPO todos salvo D                      A=116 B=59 C=58                      E=35 H=62,5 Z=22                      r.o. 7608131</p>
 <p><b>90017</b>                      FIAT UNO Diesel                      desde '89- UNO CS                      A=117 B=59 C=58                      E=35 H=77,5 Z=22                      r.o. 7643294</p>	 <p><b>90038</b>                      FIAT SCUDO-ULYSSE                      A=122 B=59 C=58                      E=44 H=69 Z=27                      r.o. 1311508030</p>	 <p><b>90031</b>                      FIAT DUCATO desde                      '90 hasta '94                      A=139 B=73 C=70                      E=50 H=101 Z=28                      r.o. 7657422</p>
 <p><b>90039</b>                      FIAT DUCATO 10-14                      desde '94                      A=139 B=73 C=71                      E=50 H=101 Z=28                      r.o. 1300472080</p>	 <p><b>90040</b>                      FIAT DUCATO 18                      desde '94                      A=156 B=80 C=78                      E=55 H=100 Z=35                      r.o. 1307355080</p>	 <p><b>90052</b>                      FIAT BRAVO.A 2.0 y                      JTD - ALFA 145-146                      A=116 B=59 C=58                      E=42 H=71,5 Z=25                      1.9 JTD, r.o. 60809805</p>



## BUJES DE RUEDA



















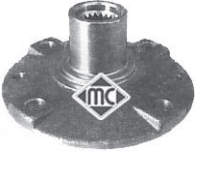
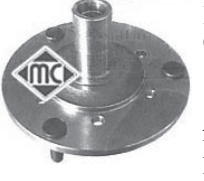

### FIAT - FORD - OPEL

 <p><b>90501</b> <b>TRASERO</b> FIAT REGATA UNO hasta '89</p> <p><b>CONRODAMIENTO</b> A=116 B=59 C=58 E=30 H=62,5 r.o.4381043-7603485</p>	 <p><b>90508</b> <b>TRASERO</b> ALFA 145-146 sin ABS BRAVO.A sin ABS PUNTO sin ABS TIPO sin ABS A=117 B=59 C=58 E=30 H=62 r.o.7787124</p>	 <p><b>90509</b> <b>TRASERO</b> ALFA 145-146 con ABS BRAVO.A con ABS PUNTO con ABS TIPO con ABS A=117 B=59 C=58 E=30 H=62 r.o.60811481</p>
 <p><b>90523</b> <b>TRASERO</b> FIAT PUNTO con ABS FIAT PALIO con ABS</p> <p><b>CONRODAMIENTO</b> A=116,5 B=59 C=58 E=30 H=62 r.o.7769902</p>		
 <p><b>90021</b> FORDESCORT '81 a '91</p> <p>A=130 B=63,5 C=63 E=35 H=82 Z=23 r.o.1644842</p>	 <p><b>90022</b> FORD FIESTA '89 a '94 COURIER '89 a '94</p> <p>A=131 B=63,5 C=63 E=35 H=70 Z=23 r.o.6517014</p>	 <p><b>90041</b> FORDESCORT desde '91 FIESTA '94-COURIER '94 FIESTA '96 - KA FOCUS salvo RS A=131 B=63,5 C=63 E=39 H=74,5 Z=25 r.o.6517013</p>
 <p><b>90060</b> FORD MONDEO FOCUS "RS"</p> <p>A=134 B=63,5 C=63 E=40 H=76 Z=27 r.o.7346525</p>	 <p><b>90064</b> FORD GALAXY</p> <p>A=141 B=68 C=57 E=43 H=89 Z=38 r.o.7201007</p>	 <p><b>90098</b> FORD TRANSIT '92 y '95</p> <p>A=212 E=120 r.o.1077708</p>
 <p><b>90042</b> OPEL ASTRA-F 1.7D-TD</p> <p>A=120 B=56,5 C=56,5 E=39 H=81 Z=22 r.o.326196</p>	 <p><b>90004</b> OPEL ASTRA-F 1.4-1.6 CORSA A-B KADETT VECTRA-A A=120 B=56,5 C=56,5 E=34 H=78 Z=22 r.o.326197</p>	 <p><b>90005</b> OPEL ASTRA-F 1.8-2.0 1.7D-TD VECTRA-A KADETT A=120 B=56,5 C=56,5 E=39 H=81 Z=33 r.o.326184</p>
 <p><b>90043</b> ASTRA-F 1.8-2.0 desde '95 VECTRA-B (4 agujeros)</p> <p>A=120 B=56,5 C=56,5 E=39 H=81 Z=33 r.o.326194</p>	 <p><b>90055</b> VECTRA-B (5 agujeros) CALIBRA (5 agujeros)</p> <p>A=137 B=70 C=65 E=39 H=81 Z=33 r.o.326195</p>	 <p><b>90524</b> <b>TRASERO</b> ASTRA-F KADETT VECTRA-A/B <b>CONRODAMIENTO</b> A=136 B=57 C=56,5 H=106 r.o.1604307</p>





















## BUJES DE RUEDA

### PEUGEOT/CITROËN - RENAULT

 <p><b>90000</b> PEUGEOT J5 hasta '90 CITROEN C25 hasta '90</p> <p><b>A=139 B=73 C=70</b> <b>E=50 H=101 Z=28</b> r.o.</p>	 <p><b>90012</b> PEUGEOT 205-206-306-307-405-406 BERLINGO-PARTNER BX - XSARA - ZX XANTIA (salvo 2.0-2.1)</p> <p><b>A=128,5 B=66 C=65</b> <b>E=42 H=66 Z=25</b> r.o. 3307.72 - 3307.69</p>	 <p><b>90013</b> CITROEN C15 desde '89 ZX 1.4 s/ABS-AX-SAXO PEUGEOT 106 hasta '96 PEUGEOT 205 1.1-1.4 PEUGEOT 306 1.4 s/ABS</p> <p><b>A=128,0 B=66 C=65</b> <b>E=35 H=67 Z=21</b> r.o. 3307.49</p>
 <p><b>90031</b> PEUGEOT J5 desde '90 CITROEN C25 desde '90</p> <p><b>A=139 B=73 C=70</b> <b>E=50 H=101 Z=28</b> r.o.</p>	 <p><b>90038</b> PEUGEOT EXPERT-806 CITROEN JUMPY EVASION</p> <p><b>A=122 B=59 C=58</b> <b>E=44 H=69 Z=27</b> r.o. 3307.64</p>	 <p><b>90039</b> PEUGEOT BOXER CITROEN JUMPER 1.000-1.400 KGS</p> <p><b>A=139 B=73 C=71</b> <b>E=50 H=101 Z=28</b> r.o. 3307.65</p>
 <p><b>90040</b> PEUGEOT BOXER CITROEN JUMPER 1.800 KGS</p> <p><b>A=156 B=80 C=78</b> <b>E=55 H=100 Z=35</b> r.o. 3307.66</p>	 <p><b>90044</b> CITROEN AX - SAXO PEUGEOT 106 (rueda de 3 agujeros)</p> <p><b>A=119 B=57 C=55</b> <b>E=35 H=60,5 Z=21</b> r.o. 3307.44</p>	 <p><b>90045</b> PEUGEOT 106 desde '96 PEUGEOT 206 1.1-1.4 PEUGEOT 206 1.9D</p> <p><b>A=129,5 B=66 C=65</b> <b>E=37 H=68 Z=21</b> r.o. 3307.76</p>
 <p><b>90066</b> CITROEN XANTIA 2.0 - 2.1 TurboD</p> <p><b>A=128,5 B=66 C=65</b> <b>E=42 H=77 Z=25</b> r.o. 3307.75</p>	 <p><b>90015</b> RENAULT 9-11-19(1.2) EXPRESS TWINGO</p> <p><b>A=121 B=61 C=60</b> <b>E=35 H=74 Z=21</b> r.o. 7700719140</p>	 <p><b>90019</b> RENAULT 4-5-6 CLIO 1.1-1.2-1.4</p> <p><b>A=156</b> <b>E=30 H=70,5 Z=23</b> r.o. 7700533798</p>
 <p><b>90020</b> RENAULT 19-21 GTS CLIO 1.7-1.8-1.9D KANGOO-MEGANE CLIO '98-SCENIC 1.4-1.6</p> <p><b>A=121 B=61 C=60</b> <b>E=37 H=75,5 Z=21</b> r.o. 7700768318 - 319</p>	 <p><b>90033</b> RENAULT 18 21 TXE y DIESEL R-25</p> <p><b>A=121 B=61 C=60</b> <b>E=40 H=69 Z=23</b> r.o. 7700715149</p>	 <p><b>90067</b> RENAULT ESPACE LAGUNA-1 SCENIC 2.0 y 1.9dT</p> <p><b>A=130 B=61 C=60</b> <b>E=40 H=73 Z=23</b> r.o. 7700830220</p>
 <p><b>90097</b> RENAULT 12</p> <p><b>A=178</b> <b>E=34 H=82 Z=</b> r.o.</p>	 <p><b>90068</b> SCENIC 1.6 desde '99</p> <p><b>A=121 B=61 C=60</b> <b>E=37 H=76 Z=23</b> r.o. 7700415121</p>	 <p><b>90093</b> TRAFIC-I (23 dientes)</p> <p><b>A=189</b> <b>E=42 H=81 Z=23</b> r.o. 7700697414</p>
 <p><b>90094</b> TRAFIC-I (25 dientes)</p> <p><b>A=189</b> <b>E=42 H=81 Z=25</b> r.o. 7700749382</p>	 <p><b>90095</b> TRAFIC-II ('01-)</p> <p><b>A=153 B=72 C=71</b> <b>E=45 H=79 Z=27</b> r.o. 7700415121</p>	 <p><b>90527</b> TRASERO R 18-21/TXE y D - R 25 CLIO-EXPRESS SCENIC - ESPACE CONRODAMIENTO</p> <p><b>A=132,5 B=66 C=60</b> <b>E=25 H=75,5</b> r.o. 7701204667</p>

## BUJES DE RUEDA

### SEAT - VOLKSWAGEN/AUDI/SKODA

 <p><b>90009</b> SEAT PANDA-TERRA</p> <p>A=117 B=59 C=58 H=70 Z=20 r.o.XO-3981586</p>	 <p><b>90002</b> SEAT IBIZA hasta '93 MALAGA</p> <p>A=117 B=59 C=58 E=35 H=77,5 Z=22 r.o.SE-138140304A</p>	 <p><b>90501</b> <b>TRASERO</b> SEAT IBIZA hasta '93 MALAGA</p> <p>A=116 B=59 C=58 E=30 H=62,5 r.o.SE-140900202</p>
 <p><b>90035</b> SEAT IBIZA '93 c/ABS INCA-CADDY c/ABS TOLEDO salvo 2.0 VW PASSAT '93-'96 GOLF-2 con ABS A=120,5 B=65 C=57 E=40 H=74 Z=22 r.o.357407613B</p>	 <p><b>90073</b> SEAT IBIZA '93 s/ABS INCA-CADDY sin ABS GOLF-3 salvo 2.0-2.8 PASSAT '88-'96 s/ABS GOLF-2 s/ABS d/'88 A=120,5 B=65 C=57 E=40 H=74 Z=22 r.o.357407615</p>	 <p><b>90100</b> POLO '02- IBIZA '02- FABIA '02-</p> <p><b>delantero</b> <b>CONRODAMIENTO</b></p> <p>r.o.6Q0407621AJ</p>
 <p><b>90048</b> TOLEDO 2.0-16v GOLF-3 2.0-2.8 PASSAT '93-'96 2.0-2.8</p> <p>A=126,5 B=65 C=57 E=40 H=74 Z=36 r.o.1H0407613B</p>	 <p><b>90063</b> TOLEDO '99-LEON SKODA OCTAVIA GOLF 4 AUDIA 3 A=126,5 B=65 C=57 E=40 H=74 Z=36 r.o.1J0407613C</p>	 <p><b>90053</b> VW PASSAT '97 salvo 1.9TDi ni 2.8V6 AUDIA 4 salvo 1.9TDi y 2.8V6 A=131 B=68 C=57 E=39/41 H=75 Z=33 r.o.8D0407615E</p>
 <p><b>90054</b> PASSAT '97 - AUDIA 4 1.9TDi y 2.8V6 AUDI 100 desde '91 AUDIA 6 A=131 B=68 C=57 E=43/45 H=75 Z=38 r.o.4A0407615D</p>	 <p><b>90074</b> VW PASSAT '88 a '93 con ABS</p> <p>A=120,5 B=65 C=57 E=40 H=74 Z=22 r.o.357407615A</p>	 <p><b>90064</b> <b>DELANT.y TRASERO</b> SEAT ALHAMBRA VW SHARAN</p> <p>A=141 B=68 C=57 E=43 H=89 Z=38 r.o.7M0501655D</p>
 <p><b>90018</b> VW POLO hasta '94</p> <p>A=120,5 B=65 C=57 E=34 H=74 Z=20 r.o.861407615A</p>	 <p><b>90034</b> SEAT AROSA VW POLO '95 VW LUPO</p> <p>A=120,5 B=65 C=57 E=35 H=74 Z=22 r.o.6N0407613</p>	 <p><b>90008</b> VW GOLF-2 hasta '88</p> <p>A=122,5 B=65 C=57 E=35 H=74 Z=22 r.o.191407615</p>
 <p><b>90025</b> AUDI 80-90 desde '88 hasta '92</p> <p>A=127 B=68 C=57 E=39/41 H=82,5 Z=33 r.o.8A0407615</p>	 <p><b>90096</b> <b>DELANT.y TRASERO</b> VW TRANSPORTER</p> <p>A=141 B=68 C=57 E=45 H=91 Z=38 r.o.7D0501647A</p>	 <p><b>90521</b> <b>TRASERO</b> TOLEDO '99-LEON GOLF 4 AUDIA 3</p> <p>A=120 B=65 C=57 E=30 H=63,7 r.o.1J0598477</p>
 <p><b>90503</b> <b>TRASERO</b> POLO '02- IBIZA '02- FABIA '02-</p> <p><b>CONRODAMIENTO</b></p> <p>r.o.6Q0598611</p>		

## BUJES DE RUEDA

### SEAT - VOLKSWAGEN/AUDI/SKODA

 <p><b>90525</b>  <b>TRASERO</b>            SEAT AROSA d/'98            VW POLO desde '99            VW LUPO            SEAT IBIZA desde '98  <b>A=120 B=65 C=57</b>  <b>E=28 H=65</b>            r.o. 6X0598477</p>	 <p><b>90516</b>  <b>MGTA. TRASERA</b>  <b>freno tambor sin ABS</b>            AUDI 80-90 - GOLF-1            IBIZA '93 - TOLEDO            POLO '95 - GOLF-2/3            PASSAT hasta '88            r.o. 357501117</p>	 <p><b>90539</b>  <b>TRASERA IZQDA.</b>  <b>freno tambor con ABS</b>            SEAT AROSA            IBIZA '93 - TOLEDO            GOLF-2/3            VW POLO '95            r.o. 333501117A</p>
 <p><b>90540</b>  <b>TRASERA DERECHA</b>  <b>freno tambor con ABS</b>            SEAT AROSA            IBIZA '93 - TOLEDO            GOLF-2/3            VW POLO '95            r.o. 333501118A</p>	 <p><b>90541</b>  <b>TRASERA IZQDA.</b>  <b>freno de disco</b>            IBIZA '93 - TOLEDO            GOLF-2/3            VW POLO '95            VW PASSAT hasta '96            r.o. 333501117</p>	 <p><b>90542</b>  <b>TRASERA DERECHA</b>  <b>freno de disco</b>            IBIZA '93 - TOLEDO            GOLF-2/3            VW POLO '95            VW PASSAT hasta '96            r.o. 333501118</p>

## ABRAZADERAS TUBO DE ESCAPE

### NORMALES, varilla de 8 mm.



**392** -32 mm

**372** -38 mm

**397** -40 mm

**398** -43 mm

**399** -45 mm

**400** -48 mm

**401** -51 mm

### TIPO FORD, varilla de 10 mm con tuerca autoblocante cobreada y arandela plana



**591** -41 mm

**592** -43 mm

**593** -44,5 mm

**594** -48 mm

**595** -50,5 mm

**596** -53 mm

**597** -57 mm

**598** -61 mm

**608** -64 mm

**610** -67 mm

**612** -69 mm

**625** -76 mm

**627** -85 mm

**630** -98 mm

**631** -110 mm

### COLLARINES DE COLECTOR

**390** especial Seat/Fiat 127-Panda, espárragos soldados

**4278** Ø 48 mm

**4277** Ø 53 mm

**643** Ø 58 mm

**748** Ø 66 mm

**749** Ø 69 mm

**4275** Ø 72 mm



**042** tuerca colector (latón M-8/125 altura 14 mm)



## JUNTAS y KITS MONTAJE COLECTORES DE ESCAPE

### JUNTAS CONICAS (sin amianto):

fabricadas con alambre de acero inoxidable prensado con mica



<b>2450</b>	Ø42 x 57 mm	Opel Corsa 1.0/1.2
<b>2393</b>	Ø46 x 60 mm	Peugeot 205 D y TU, 309 D, 405 GL/D Citroën C/15 Diesel, AXBX-14TU Opel Kadett - Corsa 1.3/1.6/Astra Fiat Uno - Daewoo Nexia
<b>2431</b>	Ø50 x 67 mm	Ford Escort / Orion / Fiesta desde '87 Opel Kadett-Astra 2.0 y 16v-Vectra Honda Civic - Concerto
<b>2383</b>	Ø51 x 65 mm	Renault 21 TXE y Diesel - R 25 TXE Audi 80D-TD
<b>4166</b>	Ø52 x 66 mm	Renault Clio/Kangoo Diesel
<b>2381</b>	Ø52 x 67 mm	Renault Clio 1.1/1.2/1.4 - R-19 TSE-R21 Super 5 (salvo 1.7) Express todas Renault Twingo - Mazda 323
<b>2788</b>	Ø55 x 64 mm	Ford Fiesta-Escort con catalizador Ford Transit
<b>2394</b>	Ø58 x 71 mm	Citroën BX TurboD y C-15 E hasta '89 Renault Safrane - Audi 80/90 Astra-F/G Diesel
<b>4154</b>	Ø58 x 72 mm	Renault 19 TurboD Renault Laguna-Safrane
<b>2432</b>	Ø60 x 69 mm	Ford Escort 1.8 - Sierra (Catalizador)
<b>2395</b>	Ø66 x 79 mm	Citroën BX GTI-16v., 405, 205, 309 Citroën ZX - XM
<b>2382</b>	Ø73 x 90 mm	Renault 19 1.7/1.8 - Clio 1.7/1.8 Golf - Caddy Diesel
<b>2433</b>	Ø75 x 93 mm	Ford Mondeo - Escort ('92) - Orion ('92) Fiesta '92
<b>2890</b>	Ø85 x 103 mm	Clio 16v-Laguna 16v

### JUNTAS DE ESCAPE PARA APLICACIONES ESPECIFICAS:



<b>2780</b>	junta entre colectores de escape y culata IBIZA - CORDOBA - INCA 1.6-1.8-2.0 TOLEDO 1.6-1.8-2.0 y Diesel GOLF-3/4 1.8-2.0 y Diesel
-------------	---

028129589B

### KITS MONTAJE COLECTORES ESCAPE VW - OPEL:



<b>2779</b>	Golf-2/Toledo-1 1.6/ VW Passat-'88
-------------	------------------------------------



<b>2619</b>	Corsa A 1.0 - 1.2 - 1.3N - 1.4NZ Corsa B 1.2 - 1.4 (salvo 16v) Kadett 1.3N - 1.6NZ / Vectra 1.6SV (longitud total pernos 66 mm)
<b>2620</b>	Corsa B 1.4(16v) - 1.6(16v) (longitud total pernos 70 mm)

## KITS MONTAJE COLECTORES DE ESCAPE PSA



**2390**

C15 1.1-1.4 gasolina hasta '89  
BX 1.9 TurboD



**2391**

BX 19GTi  
PEUGEOT 205-309 1.6 (XU5M)



**2941**

BERLINGO-PARTNER 1.1-1.4y 1.9XUD  
SAXO 1.4



**2938**

CITROEN BERLINGO 1.9DW8  
CITROEN JUMPY-EVASION 1.9DW8  
PEUGEOT EXPERT-806 1.9DW8  
PEUGEOT 206 1.9DW8  
PEUGEOT 306 1.9DW8  
PEUGEOT PARTNER 1.9DW8



**2392**

C15 1.1-1.4 motor TU y Diesel desde '89  
AX 1.1-1.4-1.4D  
SAXO 1.1-1.5D  
JUMPER-BOXER 1.9D  
PEUGEOT 205 1.1-1.4 motor TU y 1.7D  
PEUGEOT 405 1.4TU  
CITROEN XANTIA 1.9D  
CITROEN BX 14-16-19y 19D



**2940**

BERLINGO-PARTNER 1.7XUD  
JUMPER-BOXER 1.9D-2.5D-2.5TD  
XANTIA 1.6-1.8-2.0-2.1TD-2.0HDi  
XSARA 1.8-2.0 hasta '99 / ZX todos  
PEUGEOT 106 1.4 (TU3M) y 1.4D  
PEUGEOT 206 2.0-16v / 306 1.8-2.0  
PEUGEOT 405 1.6-1.8 (XU)  
PEUGEOT 406 1.6-1.8-2.0-2.1TD



**2952**

CITROEN JUMPY-EVASION 1.9D (XUD9)  
FIAT SCUDO-ULYSSE 1.9D (PSA-XUD9)  
PEUGEOT EXPERT-806 1.9D (XUD9)



**2950**

CITROEN JUMPY-EVASION 2.0HDi  
FIAT SCUDO-ULYSSE 2.0JTD (HDi)  
PEUGEOT EXPERT-806 2.0HDi



**2951**

JUMPY-EVASION 1.9TD (XUD9TE)  
FIAT SCUDO-ULYSSE 1.9TD motor PSA  
PEUGEOT EXPERT 1.9TD (XUD9TE)



**2939**

BERLINGO-PARTNER 2.0HDi  
XSARA 2.0HDi  
PEUGEOT 306 2.0HDi



**2964**

AX con catalizador  
SAXO 1.6  
PEUGEOT 106 1.4 Rallye (TU3J) y 1.6



**2973**

PEUGEOT 106 1.5D (TUD5)  
PEUGEOT 405 1.9D (XUD9)



**4039**

XANTIA 1.9SD-1.9TD  
XSARA 1.9TD (XUD9TE)  
PEUGEOT 306 1.6



**4040**

PEUGEOT 306 1.9TD (XUD9TE)  
PEUGEOT 405 1.9TD (XUD9TE)  
PEUGEOT 406 1.9SD



**4041**

PEUGEOT 406 1.9TD (XUD9TE)



**4065**

PEUGEOT 206 1.1-1.4-1.6 (TU)  
PEUGEOT 307 1.4-1.6 (TU)

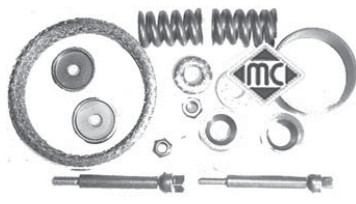

**4598**

PEUGEOT BOXER 2.0HDi-2.8HDi  
CITROEN JUMPER 2.0HDi-2.8HDi

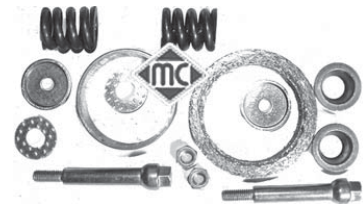



**4599**

PEUGEOT BOXER SOFIM 2.5D-2.8TD  
CITROEN JUMPER SOFIM 2.5D-2.8TD

## LATIGUILLOS DE FRENO

### ALFA ROMEO

	<b>96003</b>	<b>DELT TRAS</b>	ALFA 145 - 146 - 155 - 156 ALFA 156	435mm
	<b>96007</b>	<b>TRAS</b>	ALFA 145 - 146 - 155	185mm

### AUDI



	<b>96008</b>	<b>DELT</b>	AUDI A4 - A6 AUDI 80/90-'96	310mm
	<b>96002</b>	<b>TRAS derecho</b>	AUDI 80-90	235mm
	<b>96004</b>	<b>TRAS izquierdo</b>	AUDI 80-90	225mm
	<b>96013</b>	<b>DELT</b>	AUDI A3	435mm
	<b>96014</b>	<b>TRAS</b>	AUDI A3	165mm
	<b>96011</b>	<b>TRAS</b>	AUDI A4 - A6	205mm
	<b>96111</b>	<b>TRAS</b>	AUDI A4 - A6	195mm

### BMW















	<b>96005</b>	<b>DELT</b>	BMW s/3 E36 '91-'98	425mm
	<b>96006</b>	<b>TRAS</b>	BMW s/3 E36 '91-'98 fr. tambor (freno de tambor)	200mm
	<b>96019</b>	<b>TRAS</b>	BMW s/3 E36 '91-'98 fr. disco BMW s/3 E30 '82-'91 BMW s/5 E28-E34 '87-'95	225mm
	<b>96021</b>	<b>DELT</b>	BMW s/3 E46 '98-	405mm
	<b>96025</b>	<b>TRAS</b>	BMW s/3 E46 '98- BMW s/3 E36 '91- (ABS+ASC)	225mm
	<b>96027</b>	<b>DELT</b>	BMW s/5 E34 '87-'95 BMW s/5 E28 '81-'87	420mm

## LATIGUILLOS DE FRENO

### BMW (cont.)

	<b>96028</b>	<b>TRAS</b>	BMW s/5 E28-E34 ('81-'95) freno de disco	200mm
	<b>96034</b>	<b>DELT</b>	BMW s/5 E39 '95-	405mm











### CITROEN

	<b>96009</b>	<b>DELT</b>	CITROEN C15 CITROEN AX	352mm
	<b>96020</b>	<b>TRAS</b>	CITROEN AX	218mm
	<b>96010</b>	<b>TRAS</b>	CITROENC15	205mm
	<b>96107</b>	<b>DELT</b>	CITROENBX	460mm
	<b>96046</b>	<b>DELT</b>	CITROENSAXO (rueda de 3 agujeros)	355mm
	<b>96180</b>	<b>DELT</b>	CITROENSAXO (rueda de 4 agujeros)	325mm
	<b>96023</b>	<b>TRAS</b>	CITROENSAXO	220mm
	<b>96140</b>	<b>DELT</b>	CITROENZX	460mm
	<b>96031</b>	<b>TRAS</b>	CITROENZX (berlina)	265mm
	<b>96044</b>	<b>TRAS</b>	CITROENZX (familiar)	177mm
	<b>96148</b>	<b>DELT</b>	CITROEN XANTIA	385mm
	<b>96015</b>	<b>DELT</b>	CITROENBERLINGO CITROEN XSARA	483mm
	<b>96031</b>	<b>TRAS</b>	CITROEN XSARA	265mm
	<b>96016</b>	<b>TRAS</b>	CITROENBERLINGO	255mm



















## LATIGUILLOS DE FRENO

### CITROEN (cont.)

	<b>96032</b>	<b>DELT</b>	CITROENJUMPY-EVASION	515mm
	<b>96167</b>	<b>TRAS</b>	CITROENJUMPY-EVASION	275mm
	<b>96144</b>	<b>DELT</b>	CITROENC25	460mm
	<b>96095</b>	<b>TRAS</b>	CITROENC25	285mm
	<b>96102</b>	<b>DELT</b>	CITROENJUMPER	490mm
	<b>96145</b>	<b>TRAS</b>	CITROENJUMPER	360mm
	<b>96152</b>	<b>DELT</b>	CITROENC3	479mm
	<b>96154</b>	<b>TRAS</b>	CITROENC3	360mm
	<b>96170</b>	<b>DELT</b>	CITROENC5	582mm
	<b>96201</b>	<b>TRAS</b>	CITROENC5	mm

## LATIGUILLOS DE FRENO

### FIAT













	<b>96017</b>	<b>DELT</b>	FIATUNO-REGATA	436mm
	<b>96020</b>	<b>TRAS</b>	FIATUNO FIATPUNTO-I'93-'99	218mm
	<b>96022</b>	<b>DELT</b>	FIAT TIPO	405mm
	<b>96024</b>	<b>TRAS</b>	FIAT TIPO	245mm
	<b>96045</b>	<b>DELT</b>	FIATPUNTO-I'93-'99	420mm
	<b>96050</b>	<b>DELT</b>	FIATPUNTO-II'99-	480mm
	<b>96051</b>	<b>TRAS</b>	FIATPUNTO-II'99-	195mm
	<b>96033</b>	<b>DELT</b>	FIATBRAVO-BRAVA	415mm
	<b>96031</b>	<b>TRAS</b>	FIATBRAVO-BRAVA 1.8	245mm
	<b>96042</b>	<b>DELT</b>	FIATMAREA FIATSTILO	435mm
	<b>96043</b>	<b>TRAS</b>	FIATMAREA-BRAVO/A-PALIO	250mm
	<b>96210</b>	<b>DELT</b>	FIATDOBLO-SIENA-PALIO	500mm
	<b>96211</b>	<b>TRAS</b>	FIATDOBLO	465mm
	<b>96032</b>	<b>DELT</b>	FIATSCUDO-ULYSSE	520mm
	<b>96167</b>	<b>TRAS</b>	FIATSCUDO-ULYSSE	260mm
	<b>96144</b>	<b>DELT</b>	FIATDUCATO hasta '94	455mm
	<b>96095</b>	<b>TRAS</b>	FIATDUCATO hasta '94	290mm

## LATIGUILLOS DE FRENO

### FIAT (cont.)

















	<b>96102</b>	<b>DELT</b>	FIAT DUCATO desde '94	480mm
	<b>96145</b>	<b>TRAS</b>	FIAT DUCATO desde '94	350mm

### FORD

	<b>96040</b>	<b>DELT</b>	FORD FIESTA '83 a '89	385mm
	<b>96036</b>	<b>TRAS</b>	FORD FIESTA '76 a '89	315mm
	<b>96055</b>	<b>DELT</b>	FORD FIESTA '89-'02 FORD COURIER desde '89	415mm
	<b>96062</b>	<b>TRAS</b>	FORD FIESTA '96- FORD COURIER desde '96	335mm
	<b>96047</b>	<b>TRAS</b>	FORD FIESTA '89-'96 COURIER '89-'96	340mm
	<b>96039</b>	<b>DELT</b>	FORDESCORT '86 a '91	375mm
	<b>96037</b>	<b>TRAS</b> <b>izquierdo</b>	FORDESCORT '86 a '91	250mm
	<b>96038</b>	<b>TRAS</b> <b>derecho</b>	FORDESCORT '86 a '91	225mm
	<b>96081</b>	<b>DELT</b> <b>izquierdo (macho)</b>	FORDESCORT '91 a '97	470mm
	<b>96080</b>	<b>DELT</b> <b>derecho (macho)</b>	FORDESCORT '91 a '97	470mm
	<b>96052</b>	<b>DELT</b> <b>izquierdo (hembra)</b>	FORDESCORT '91 a '97	450mm
	<b>96048</b>	<b>DELT</b> <b>derecho (hembra)</b>	FORDESCORT '91 a '97	450mm
	<b>96141</b>	<b>TRAS</b>	FORDESCORT '91 a '97	495mm

## LATIGUILLOS DE FRENO











### FORD (cont.)

	<b>96054</b>	<b>DELT</b>	FIESTA '02-FUSION	520mm
	<b>96057</b>	<b>TRAS</b>	FIESTA '02-FUSION	320mm
	<b>96074</b>	<b>DELT</b>	FORDKA	535mm
	<b>96077</b>	<b>TRAS</b>	FORDKA	390mm
	<b>96082</b>	<b>DELT</b>	FORDFOCUS-CONNECT	370mm
	<b>96084</b>	<b>TRAS</b>	FORDFOCUS	225mm
	<b>96063</b>	<b>DELT</b>	FORDMONDEO-I/II	425mm
	<b>96068</b>	<b>TRAS</b>	FORDMONDEO-I/II	305mm
	<b>96061</b>	<b>TRAS</b>	FORDMONDEO-I/II	315mm
	<b>96066</b>	<b>DELT</b>	FORDMONDEO-III	476mm
	<b>96067</b>	<b>TRAS</b>	FORDMONDEO-III	mm
	<b>96069</b>	<b>DELT</b>	FORDGALAXY	495mm
	<b>96070</b>	<b>TRAS</b>	FORDGALAXY	170mm
	<b>96184</b>	<b>DELT</b>	FORDTRANSIT desde '91 a '99 izquierdo	430mm
	<b>96185</b>	<b>DELT</b>	FORDTRANSIT desde '91 a '99 derecho	430mm
	<b>96186</b>	<b>TRAS</b>	FORDTRANSIT desde '91 a '00 simple, alternativamente a MC-96071	420mm
	<b>96071</b>	<b>TRAS</b>	FORDTRANSIT desde '91 a '00 doble, alternativamente a MC-96186	





## LATIGUILLOS DE FRENO

### MERCEDES BENZ

















	<b>96193</b>	<b>DELT</b>	MERCEDES W123 - W124 y W201(190)	340mm
	<b>96212</b>	<b>DELT</b>	MERCEDES CLASE C (W202)	505mm
	<b>96085</b>	<b>DELT</b>	MERCEDES CLASE E (W210)	415mm
	<b>96073</b>	<b>TRAS</b>	MERCEDES W123-W124-W201 W202-W203-W210	310mm
	<b>96086</b>	<b>DELT</b>	MERCEDES CLASE A	280mm
	<b>96091</b>	<b>TRAS</b>	MERCEDES CLASE A	340mm
	<b>96121</b>	<b>DELT</b>	MB - FURGONETAS	370mm
	<b>96194</b>	<b>DELT</b>	MERCEDES VITO	495mm
	<b>96195</b>	<b>TRAS</b>	MERCEDES VITO	525mm
	<b>96093</b>	<b>DELT y TRAS</b>	MERCEDES SPRINTER	363mm

### NISSAN

	<b>96092</b>	<b>DELT</b>	NISSAN MICRA '92-	483mm
	<b>96094</b>	<b>TRAS</b>	NISSAN MICRA '92-	218mm
	<b>96103</b>	<b>DELT</b>	NISSAN PRIMERA '96- <b>derecho</b>	421mm
	<b>96120</b>	<b>DELT</b>	NISSAN PRIMERA '96- <b>izquierdo</b>	421mm
	<b>96122</b>	<b>TRAS</b>	NISSAN PRIMERA '96- <b>derecho</b>	289mm
	<b>96123</b>	<b>TRAS</b>	NISSAN PRIMERA '96- <b>izquierdo</b>	289mm

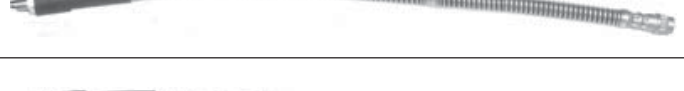



## LATIGUILLOS DE FRENO

### NISSAN (cont.)

	<b>96127</b>	<b>DELT</b>	NISSAN TERRANO-II <b>derecho</b>	343mm
	<b>96129</b>	<b>DELT</b>	NISSAN TERRANO-II <b>izquierdo</b>	462mm
	<b>96130</b>	<b>TRAS</b>	NISSAN TERRANO-II	462mm
	<b>96132</b>	<b>DELT</b>	NISSAN PATROL (eje)	413mm
	<b>96133</b>	<b>DELT</b>	NISSAN PATROL (rueda)	340mm
	<b>96135</b>	<b>DELT</b>	NISSAN VANETTE hasta '93 <b>derecho</b>	454mm
	<b>96136</b>	<b>DELT</b>	NISSAN VANETTE hasta '93 <b>izquierdo</b>	454mm
	<b>96137</b>	<b>TRAS</b>	NISSAN VANETTE hasta '93	465mm
	<b>96182</b>	<b>DELT</b>	NISSAN VANETTE desde '93 NISSAN SERENA	533mm
	<b>96153</b>	<b>DELT</b>	NISSAN TRADE	550mm
	<b>96176</b>	<b>DELT</b>	NISSAN (EBRO) F-275	445mm
	<b>96204</b>	<b>DELT</b>	NISSAN PRIMASTAR	415mm
	<b>96205</b>	<b>TRAS</b>	NISSAN PRIMASTAR	230mm
	<b>96206</b>	<b>DELT</b>	NISSAN INTERSTAR	582mm
	<b>96207</b>	<b>TRAS</b>	NISSAN INTERSTAR <b>(intermedio)</b>	433mm
	<b>96208</b>	<b>TRAS</b>	NISSAN INTERSTAR	355mm
	<b>96209</b>	<b>TRAS</b>	NISSAN INTERSTAR	270mm

## LATIGUILLOS DE FRENO

### OPEL

	<b>96158</b>	<b>DELT</b>	OPEL CORSA-A/VECTRA - A KADETT - E ( <b>derecho</b> ) ASTRA - F/CALIBRA	310mm
	<b>96142</b>	<b>DELT</b>	OPEL VECTRA-B ('96-)	410mm
	<b>96089</b>	<b>DELT</b>	OPEL CORSA-B ('93-) COMBO	340mm
	<b>96159</b>	<b>TRAS</b>	OPEL CORSA-A/B OPEL KADETT-E - ASTRA-F VECTRA - B	195mm
	<b>96041</b>	<b>TRAS</b>	OPEL ASTRA - F	235mm
	<b>96188</b>	<b>DELT</b>	OPEL ASTRA-G '98-	396mm
	<b>96189</b>	<b>TRAS</b>	OPEL ASTRA-G '98-	215mm
	<b>96139</b>	<b>DELT</b>	OPEL KADETT-E ( <b>izquierdo</b> )	325mm
	<b>96131</b>	<b>DELT</b>	OPEL CORSA - C	310mm
	<b>96138</b>	<b>TRAS</b>	OPEL CORSA - C	224mm
	<b>96149</b>	<b>DELT</b>	OPEL AGILA	440mm
	<b>96150</b>	<b>TRAS</b>	OPEL AGILA	305mm
	<b>96146</b>	<b>DELT</b>	OPEL FRONTERA	435mm
	<b>96147</b>	<b>TRAS</b>	OPEL FRONTERA	468mm
	<b>96204</b>	<b>DELT</b>	OPEL VIVARO	415mm
	<b>96205</b>	<b>TRAS</b>	OPEL VIVARO	230mm
	<b>96206</b>	<b>DELT</b>	OPEL MOVANO	582mm

## LATIGUILLOS DE FRENO

### OPEL (cont.)

	<b>96207</b>	<b>TRAS</b>	OPELMOVANO (intermedio)	433mm
	<b>96208</b>	<b>TRAS</b>	OPELMOVANO	355mm
	<b>96209</b>	<b>TRAS</b>	OPELMOVANO	270mm















### PEUGEOT

	<b>96180</b>	<b>DELT</b>	PEUGEOT106 (rueda de 4 agujeros)	312mm
	<b>96046</b>	<b>DELT</b>	PEUGEOT106 (rueda de 3 agujeros)	355mm
	<b>96009</b>	<b>DELT</b>	PEUGEOT205-309	358mm
	<b>96096</b>	<b>TRAS</b>	PEUGEOT106	206mm
	<b>96160</b>	<b>DELT</b>	PEUGEOT205 1.7D-309 1.7D	440mm
	<b>96053</b>	<b>TRAS</b>	PEUGEOT205-309	275mm
	<b>96099</b>	<b>DELT</b>	PEUGEOT306	535mm
	<b>96031</b>	<b>TRAS</b>	PEUGEOT306	265mm
	<b>96162</b>	<b>DELT</b>	PEUGEOT307	445mm
	<b>96163</b>	<b>TRAS</b>	PEUGEOT307	210mm
	<b>96187</b>	<b>DELT</b>	PEUGEOT 206	325mm
	<b>96172</b>	<b>DELT</b>	PEUGEOT 405 hasta '89	510mm
	<b>96173</b>	<b>DELT</b>	PEUGEOT 405 desde '89	460mm



















## LATIGUILLOS DE FRENO

### PEUGEOT (cont.)

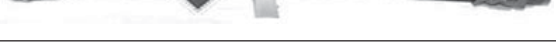
	<b>96096</b>	<b>TRAS</b>	PEUGEOT405	220mm
	<b>96190</b>	<b>DELT</b>	DERECHO PEUGEOT406	575mm
	<b>96196</b>	<b>DELT</b>	IZQUIERDO PEUGEOT406	575mm
	<b>96191</b>	<b>TRAS</b>	PEUGEOT406	305mm
	<b>96015</b>	<b>DELT</b>	PEUGEOTPARTNER	510mm
	<b>96016</b>	<b>TRAS</b>	PEUGEOTPARTNER	255mm
	<b>96023</b>	<b>TRAS</b>	PEUGEOT206(derecho)	220mm
	<b>96161</b>	<b>TRAS</b>	PEUGEOT206(izquierdo)	270mm
	<b>96032</b>	<b>DELT</b>	PEUGEOTEXPERT - 806	520mm
	<b>96167</b>	<b>TRAS</b>	PEUGEOTEXPERT - 806	275mm
	<b>96144</b>	<b>DELT</b>	PEUGEOTJ5	455mm
	<b>96095</b>	<b>TRAS</b>	PEUGEOTJ5	290mm
	<b>96102</b>	<b>DELT</b>	PEUGEOTBOXER	480mm
	<b>96145</b>	<b>TRAS</b>	PEUGEOTBOXER	350mm

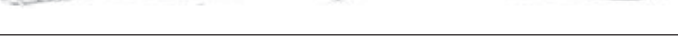













## LATIGUILLOS DE FRENO

### RENAULT

	<b>96058</b>	<b>DELT</b>	RENAULT4TL-4F6-5-6	460mm
	<b>96059</b>	<b>DELT</b>	RENAULT4-5('81)-6	508mm
	<b>96060</b>	<b>TRAS</b>	RENAULT4-5-6	268mm
	<b>96072</b>	<b>DELT</b>	RENAULT18-25-ESPACÉ	406mm
	<b>96079</b>	<b>DELT</b>	RENAULT25-ESPACÉ	430mm
	<b>96064</b>	<b>DELT</b>	RENAULT9-11	374mm
	<b>96078</b>	<b>DELT</b>	RENAULTSUPER5-EXPRESS R-21	333mm
	<b>96065</b>	<b>TRAS</b>	RENAULTSUPER5-EXPRESS R-21-LAGUNA (ex-ABS)	305mm
	<b>96161</b>	<b>TRAS</b>	RENAULT9-11-19 TWINGO	270mm
	<b>96075</b>	<b>DELT</b>	RENAULT19	290mm
	<b>96076</b>	<b>DELT</b>	RENAULT21 TXE y D TWINGO-TRAFIC	350mm
	<b>96166</b>	<b>DELT</b>	RENAULTCLIO-I	270mm
	<b>96155</b>	<b>TRAS</b>	RENAULTCLIO-I MEGANE-19	255mm
	<b>96104</b>	<b>DELT</b>	RENAULTMEGANE-I	420mm
	<b>96105</b>	<b>DELT</b>	RENAULTLAGUNA-I	480mm
	<b>96110</b>	<b>TRAS</b>	RENAULT19-21	245mm
	<b>96112</b>	<b>TRAS</b>	RENAULTLAGUNA-I con ABS	180mm

## LATIGUILLOS DE FRENO

### RENAULT (cont.)

	<b>96113</b>	<b>DELT</b>	RENAULTCLIO-II	345mm
	<b>96114</b>	<b>TRAS</b>	RENAULTCLIO-II	195mm
	<b>96119</b>	<b>DELT TRAS</b>	RENAULTKANGOO RENAULTKANGOO	357mm
	<b>96096</b>	<b>TRAS</b>	RENAULTKANGOO	220mm
	<b>96151</b>	<b>DELT</b>	RENAULTSAFRANE	410mm
	<b>96171</b>	<b>DELT</b>	RENAULTLAGUNA-II	410mm
	<b>96177</b>	<b>TRAS</b>	RENAULTLAGUNA-II	210mm
	<b>96203</b>	<b>DELT</b>	RENAULTMEGANE-II	457mm
	<b>96204</b>	<b>DELT</b>	RENAULTTRAFIC-II	415mm
	<b>96205</b>	<b>TRAS</b>	RENAULTTRAFIC-II	230mm
	<b>96206</b>	<b>DELT</b>	RENAULTMASTER '98-	582mm
	<b>96207</b>	<b>TRAS</b>	RENAULTMASTER '98- (intermedio)	433mm
	<b>96208</b>	<b>TRAS</b>	RENAULTMASTER '98-	355mm
	<b>96209</b>	<b>TRAS</b>	RENAULTMASTER '98-	270mm

## LATIGUILLOS DE FRENO

### SEAT (derivados FIAT)

	<b>96087</b>	<b>DELT</b>	SEAT 600	316mm
	<b>96088</b>	<b>DELT TRAS</b>	SEAT 850-124-1430 SEAT 127	282mm
	<b>96097</b>	<b>TRAS</b>	SEAT 600	230mm
	<b>96083</b>	<b>DELT</b>	SEAT 127	305mm
	<b>96090</b>	<b>DELT</b>	SEAT IBIZA hasta '93 MALAGA	435mm
	<b>96098</b>	<b>TRAS</b>	SEAT IBIZA hasta '93 MALAGA	325mm
	<b>96144</b>	<b>DELT</b>	SEAT PANDA - MARBELLA	455mm
	<b>96169</b>	<b>DELT</b>	SEAT TERRA	485mm
	<b>96095</b>	<b>TRAS</b>	SEAT PANDA - MARBELLA TERRA	290mm

















### SUZUKI

	<b>96115</b>	<b>DELT</b>	SUZUKI SJ410-413	295mm
	<b>96116</b>	<b>TRAS</b>	SUZUKI SJ410-413	397mm
	<b>96117</b>	<b>INIM</b>	SUZUKI SJ410-413	180mm
	<b>96183</b>	<b>DELT</b>	izquierdo SUZUKI VITARA	737mm
	<b>96178</b>	<b>DELT</b>	derecho SUZUKI VITARA	530mm
	<b>96197</b>	<b>TRAS</b>	SUZUKI VITARA	299mm



## LATIGUILLOS DE FRENO

### VAG - VOLKSWAGEN / SEAT / SKODA

	<b>96109</b>	<b>DELT</b>	VW GOLF-1/2	310mm
	<b>96111</b>	<b>TRAS</b>	VW GOLF-1-2-3 SEAT TOLEDO	160mm
	<b>96175</b>	<b>TRAS</b>	VW GOLF-1-2-3 SEAT TOLEDO	190mm
	<b>96124</b>	<b>DELT</b>	VW GOLF-3-CADDY SEAT IBIZA '93-INCA	485mm
	<b>96106</b>	<b>DELT</b>	VW POLO hasta '00	325mm
	<b>96179</b>	<b>DELT</b>	SEAT TOLEDO '91-'98	360mm
	<b>96126</b>	<b>TRAS</b>	SEAT IBIZA '93-'99	160mm
	<b>96202</b>	<b>TRAS</b>	SEAT INCA VW CADDY '93-	360mm
	<b>96199</b>	<b>TRAS</b>	VW POLO '95-'02	143mm
	<b>96128</b>	<b>DELT</b>	VW LUPO - SEAT AROSA VW POLO '00-'02	410mm
	<b>96013</b>	<b>DELT</b>	VW GOLF-4-BEETLE SKODA OCTAVIA SEAT TOLEDO 2-LEON	466mm
	<b>96014</b>	<b>TRAS</b>	VW GOLF-4-TOLEDO-2-LEON SKODA OCTAVIA POLO '02-IBIZA '02-FABIA '02-	180mm
	<b>96200</b>	<b>DELT</b>	VW POLO '02- SEAT IBIZA '02- SKODA FABIA '02-	555mm
	<b>96069</b>	<b>DELT</b>	VW SHARAN SEAT ALHAMBRA	495mm
	<b>96070</b>	<b>TRAS</b>	VW SHARAN SEAT ALHAMBRA	170mm
	<b>96192</b>	<b>DELT</b>	VW PASSAT '88 a '96 VW TRANSPORTER desde '91	370mm
	<b>96008</b>	<b>DELT</b>	VW PASSAT '97-	310mm

## LATIGUILLOS DE FRENO

















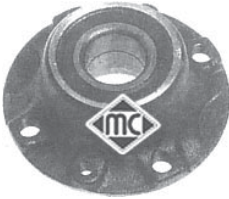

### VAG - VOLKSWAGEN / SEAT / SKODA (cont.)

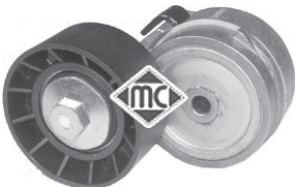
	<b>96108</b>	TRAS	VW POLO hasta '00 VW PASSAT '88 a '96 VW TRANSPORTER	205mm
	<b>96011</b>	TRAS	VW PASSAT '97-	205mm
	<b>96198</b>	TRAS	VW PASSAT '97-	225mm

## ALFA 145-146





 <p><b>2344</b> soporte motor trasero 1.4-1.6-Diesel hasta '98, r.o.</p>	 <p><b>4268</b> horquilla embrague r.o. 7617578</p>	 <p><b>2919</b> kit reparación brazo suspensión trasero completo con rodamientos</p>
 <p><b>4011</b> casquillo plástico reenvío mando cambio r.o. 4259848</p>	 <p><b>4206</b> rodamiento soporte amortiguador delantero r.o.</p>	 <p><b>1115</b> kit fuelle transmisión l/rueda 1.6-1.8-2.0 r.o.</p>
 <p><b>1996</b> kit fuelle transmisión l/rueda 1.4 r.o.</p>	 <p><b>1217</b> kit fuelle transmisión l/rueda 1.9JTD r.o.</p>	 <p><b>583</b> fuelle transmisión lado cambio r.o.</p>
 <p><b>1120</b> kit fuelle transmisión l/cambio 1.4 completo con rodamiento, r.o. 7625541</p>	 <p><b>1611</b> kit fuelle transmisión l/cambio salvo 1.4 r.o.</p>	 <p><b>1835</b> fuelle cremallera dirección r.o.</p>
 <p><b>2675</b> <span style="float: right;">Ø 19,9 mm</span> silentbloc anterior brazo suspensión delt. r.o. 7601064</p>	 <p><b>2674</b> <span style="float: right;">Ø 19,9 mm</span> silentbloc posterior <b>brazo izquierdo</b> delt. r.o. 7601065</p>	 <p><b>2673</b> <span style="float: right;">Ø 19,9 mm</span> silentbloc posterior <b>brazo derecho</b> delt. r.o.</p>
 <p><b>2899</b> <span style="float: right;">Ø 20,9 mm</span> silentbloc anterior brazo suspensión delt. r.o.</p>	 <p><b>2900</b> <span style="float: right;">Ø 20,9 mm</span> silentbloc posterior <b>brazo izquierdo</b> delt. r.o.</p>	 <p><b>2901</b> <span style="float: right;">Ø 20,9 mm</span> silentbloc posterior <b>brazo derecho</b> delt. r.o.</p>
 <p><b>2637</b> bieleta puntal barra estabilizadora completa r.o. 7601647+7601642</p>	 <p><b>2741</b> goma barra estabilizadora r.o. 7635714</p>	 <p><b>2742</b> tapón llenado aceite motor r.o. 7713649</p>

ALFA 145-146

<p><b>¡Nuevo!</b></p>  <p><b>3758</b> botella de expansión 1.4-1.6-1.8-2.0-1.9D/TD r.o. 60654720-60813480</p>	 <p><b>057</b> soporte tubo de escape TD r.o. 5989798</p>	 <p><b>280</b> soporte tubo de escape (salvo Diesel) r.o. 60624931</p>
 <p><b>2636</b> soporte tubo de escape TD r.o. 7749062</p>	 <p><b>2638</b> soporte tubo de escape JTD r.o. 46421002</p>	 <p><b>2639</b> soporte tubo de escape TD-JTD r.o. 46477073</p>
 <p><b>2753</b> soporte tubo de escape (salvo Diesel) r.o. 60652180</p>	 <p><b>90052</b> buje rueda delantera 1.9TD-JTD (25 esdrías, eje de Ø 42 mm), r.o. 60809805</p>	 <p><b>90010</b> buje rueda delantera salvo TD-JTD (25 esdrías, eje de Ø 37 mm), r.o. 7667265</p>
 <p><b>90508</b> buje rueda trasera sin "Antiskid" (ABS) r.o. 7787124</p>	 <p><b>90509</b> buje rueda trasera con "Antiskid" (ABS) r.o. 60811481</p>	 <p><b>4308</b> polea cigüeñal 1.9 JTD r.o. 0055185409-46780491</p>
<p><b>¡Nuevo!</b></p>  <p><b>4927</b> tensor correa alternador 1.9D/JTD r.o. 55180011</p>	<p><b>¡Nuevo!</b></p>  <p><b>4894</b> polea flexible de alternador r.o.</p>	<p><b>¡Nuevo!</b></p>  <p><b>5001</b> polea de alternador de rueda libre r.o. 9948225</p>
 <p><b>3572</b> tapón botella expansión 1.0 bar r.o. 1306.E1</p>	<p><b>¡Nuevo!</b></p>  <p><b>3740</b> tapón botella expansión 1.0 bar r.o. 46402982</p>	 <p><b>96003</b> latiguillo freno delantero (435 mm) r.o. 60540018</p>
 <p><b>96007</b> latiguillo freno trasero (185 mm) r.o. 60800372</p>	 <p><b>4062</b> tapón cárter aceite (18x150) r.o. 46476967</p>	 <p><b>4126</b> tapón cárter aceite (20x150) r.o.</p>



**AUDI 80 - 90 - 100**

 <p><b>7628</b> mgto superior radiador 80-1.8 hasta '91 r.o.</p>	 <p><b>7629</b> mgto inferior radiador 80-1.8 hasta '91 r.o.</p>	 <p><b>8226</b> mgto desvaporizador 1.8 r.o.050103493A</p>
 <p><b>8227</b> mgto desvaporizador 1.8 con catalizador r.o.026103493A</p>	 <p><b>3536</b> tapa de termostato 1.6-2.0 r.o.055121121F</p>	 <p><b>3535</b> brida plástico en culata 1.8 desde '91-2.0 r.o.037121133B</p>
 <p><b>3522</b> brida plástico en culata 1.6 r.o.037121133F</p>	 <p><b>3527</b> brida plástico en culata D-TD r.o.068121132AE</p>	 <p><b>3505</b> brida plástico en culata 1.8 hasta '91 r.o.037121133C</p>
 <p><b>3542</b> brida plástico en culata TDi r.o.028121132/A</p>	 <p><b>3517</b> boquilla posterior en culata r.o.026121145E</p>	 <p><b>3586</b> boquilla posterior en culata 1.6-1.8 r.o.028121144M-028121145C</p>
 <p><b>3587</b> boquilla posterior en culata 1.9D hasta '91 r.o.028121144N-028121145G</p>	 <p><b>3583</b> boquilla posterior en culata 2.0 desde '92 r.o.027121145B</p>	 <p><b>3594</b> boquilla posterior en culata 1.9 D desde '91 r.o.048121145B</p>
 <p><b>3540</b> kit tapón sensores en tapas de agua r.o.357121140+032121142</p>	 <p><b>3574</b> tapón botella de expansión r.o.443121321</p>	 <p><b>801</b> goma puntal barra estabilizadora hasta '91 r.o.823411313A</p>
 <p><b>803</b> silentbloc trapecio delantero 1.6-1.8-1.9D-2.0 con servodirección, r.o. 857407181</p>	 <p><b>2697</b> silentbloc trapecio delantero 1.6-1.8-1.9D-2.0 sin servodirección, r.o. 811407181A</p>	 <p><b>4185</b> Ø 44 mm silentbloc trapecio delantero 2.3-2.8 r.o. 893407181</p>

AUDI 80 - 90 - 100



**923** con rodamiento de Ø 14 mm  
soporte amortiguador delantero 80 - 90  
r.o. 8A0412323D/B-811412323D



**2844**  
tope amortiguador delantero 80 - 90  
r.o.



**4338**  
bioleta puntal barra estabilizadora desde '91  
a '94, r.o. 8A0407465-893407465A



**546**  
soporte motor dcho.+izqdo. motores de 4  
cilindros hasta '91, r.o. 893199381B



**2485** hidráulico  
soporte motor dcho.+izqdo. motores de 5  
cilindros hasta '91, r.o. 443199381C

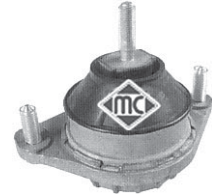

**4174** hidráulico  
soporte motor dcho.+izqdo. motores de 4  
cilindros desde '91, r.o. 8A0199381A



**4359**  
silentbloc guía soporte motor delantero  
r.o. 8D0199339F



**718**  
soporte cambio 1.8 hasta '88  
r.o. 811399151B



**2917**  
soporte cambio todos desde '88  
r.o. 893399151A-F

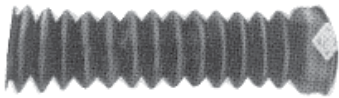

**1573**  
fuelle cremallera dirección Audi 80 - 90  
r.o. 811419831B

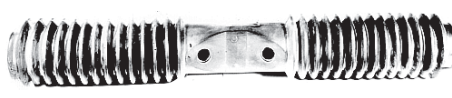

**1772**  
fuelle cremallera dirección Audi 100  
r.o. 431419831



**1642**  
kit fuelle transm. l/rueda Audi 80 y 90  
r.o. 357498203A



**1638**  
kit fuelle transm. l/rueda Audi 100  
r.o. 431407285C



**1455**  
kit fuelle transmisión lado cambio Ø 94 mm  
r.o. 191498201D



**1560**  
kit fuelle transm. izqda. l/cbo Ø 100 mm  
r.o. 321407283A



**1637**  
kit fuelle transm. izqda. l/cbo Ø 100 mm  
r.o. 191407283



**2880**  
soporte carburador 1.6 hasta '91  
r.o. 026129761E-026129761A



**3621**  
tapón llenado aceite motor  
r.o. 06A103485F



**2696**  
soporte carburador 1.8 (90CV) hasta '91  
r.o. 050129761E



**2695**  
soporte carburador 1.6-1.8-2.0 desde '91  
r.o. 050129761F



**4290**  
polea cigueñal Diesel desde '93  
r.o.

AUDI 80 - 90 - 100

<p><b>¡Nuevo!</b></p>  <p><b>3681</b> tapa superior correa distribución 1.6-1.8-2.0 r.o.026109173A</p>	<p><b>¡Nuevo!</b></p>  <p><b>3715</b> tapa superior correa distribución 1.6-1.8-2.0 r.o.026109107B</p>	<p><b>¡Nuevo!</b></p>  <p><b>3687</b> tapa inferior correa distribución 1.6-1.8-2.0 r.o.026109175A</p>
 <p><b>2448</b> guía varilla nivel aceite 1.6-1.8-2.0 r.o.053103663</p>	<p><b>¡Nuevo!</b></p>  <p><b>3688</b> guía varilla nivel aceite 1.6TD y 1.9 Diesel r.o.036115636</p>	 <p><b>864</b> cubrepedal freno y embrague r.o.</p>
<p><b>¡Nuevo!</b></p>  <p><b>3719</b> válvula desvaporizadora 1.9D r.o.028129101D</p>	<p><b>¡Nuevo!</b></p>  <p><b>3672</b> válvula filtro de gasoil r.o.191127247</p>	<p><b>¡Nuevo!</b></p>  <p><b>3737</b> interruptor luz de freno (2 polos) r.o.443945515</p>
 <p><b>2780</b> junta colector escape 1.9 D-TDi r.o.028129589B</p>	 <p><b>238</b> soporte escape hasta '91 r.o.823253147A</p>	 <p><b>2766</b> soporte escape desde '91 r.o.4A0253147A</p>
 <p><b>497</b> soporte escape r.o.431253147</p>	 <p><b>366</b> soporte escape r.o.893253147F</p>	
 <p><b>2779</b> jgo. grapa sujeción escape a colector r.o.</p>	 <p><b>674</b> tapón cárter de aceite hasta '97 r.o.N90288901</p>	 <p><b>4248</b> tornillo rueda M14x150x27 r.o.</p>
 <p><b>90025</b> buje rueda delantera 80/90 r.o.8A0407615</p>	 <p><b>90054</b> buje rueda delantera 100 desde 12/'90 r.o.4A0407615D</p>	 <p><b>90516</b> buje rueda trasera 80/90 (freno de tambor) r.o.357501117</p>

## AUDI 80 - 90 - 100



**96008**

latiguillo freno delantero (310 mm)  
r.o. 893611707



**96002**

latiguillo **derecho** freno trasero (225 mm)  
r.o. 8A0611775D



**96004**

latiguillo **izquierdo** freno trasero (225 mm)  
r.o. 8A0611775



## CANALIZACIONES DE AGUA:

A3

1.6/8v

motores AEH-AKL-APF-AVU

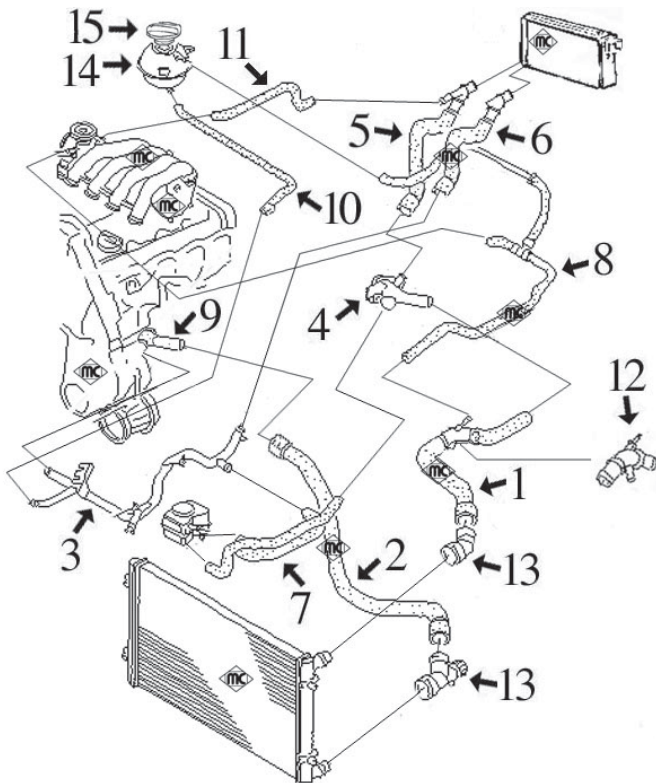

- 1- 9045 mgto superior radiador completo con conector rápido
- 2- 9046 mgto inferior radiador completo con conector rápido
- 3- 3176 tubo de agua metálico completo con junta tórica
- 4- 3598 boquilla (plástico) en culata
- 5- 9051 mgto de calefactor a boquilla en culata (con conector rápido)
- 6- 9042 mgto de calefactor a tubo metálico (con conector rápido)
- 7- 9048 mgto doble de intercambiador en filtro de aceite
- 8- n/d mgto a caja mariposa y rebose botella
- 9- 3597 boquilla en bloque (plástico)
- 10- 9043 mgto de tubo metálico a botella
- 11- n/d mgto de caja mariposa a conector en mgto calefactor
- 12- 3604 conector mgto superior completo con accesorios
- 13- 3721 juego de conectores superior/inferior en mgto radiador
- 14- 3635 botella de expansión
- 15- 3573 tapón botella de expansión

A3

1.8  
2.0

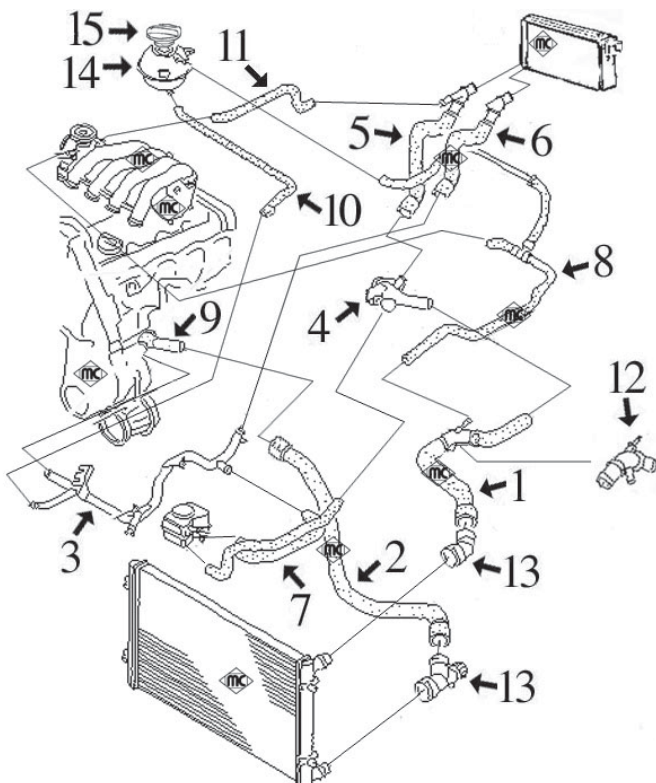

- 1- 9045 mgto superior radiador completo con conector rápido
- 2- 9046 mgto inferior radiador completo con conector rápido
- 3- 3177 tubo de agua metálico completo con junta tórica, motor 1.8
- 3176 tubo de agua metálico completo con junta tórica, motor 2.0
- 4- 3598 boquilla (plástico) en culata motor AGN
- 5- 9051 mgto de calefactor a boquilla en culata (con conector rápido)
- 6- 9042 mgto de calefactor a tubo metálico (con conector rápido)
- 7- 9048 mgto doble de intercambiador en filtro de aceite, motor 1.8
- 9049 mgto doble de intercambiador en filtro de aceite, motor 2.0
- 8- n/d mgto a caja mariposa y rebose botella
- 9- 3597 boquilla en bloque (plástico)
- 10- 9043 mgto de tubo metálico a botella
- 11- n/d mgto de caja mariposa a conector en mgto calefactor
- 12- 3604 conector mgto superior completo con accesorios
- 13- 3721 juego de conectores superior/inferior en mgto radiador
- 14- 3635 botella de expansión
- 15- 3573 tapón botella de expansión

# AUDI A3

A3

1.9 Diesel





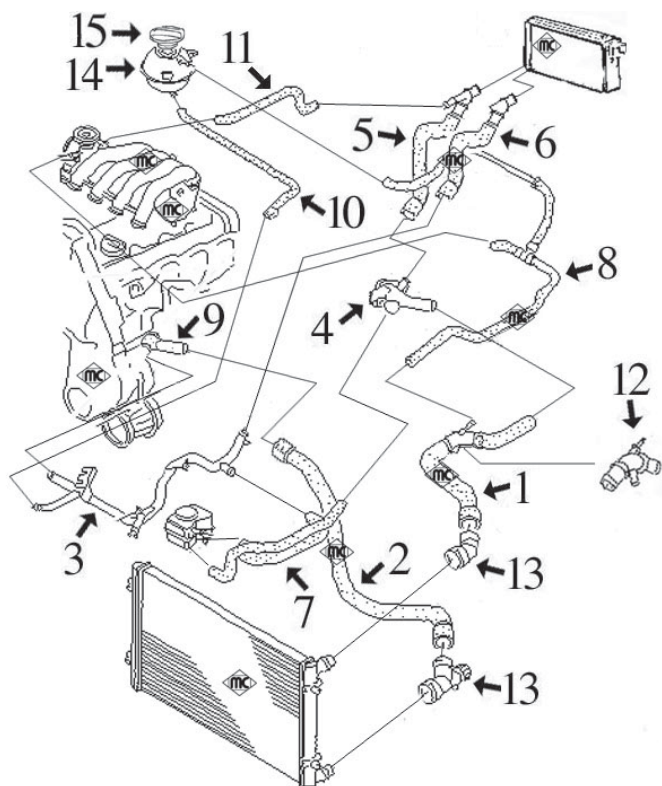





TDi de 90CV  
TDi de 110CV

motores AGR-ALH  
motores AHF-ASV



- 1- 9045 mgto superior radiador completo con conector rápido
- 2- 9046 mgto inferior radiador completo con conector rápido
- 3- 3178 tubo de agua metálico completo con junta tórica
- 4- 3591 boquilla (plástico) en culata
- 5- 9050 mgto de calefactor a boquilla en culata (con conector rápido)
- 6- 9042 mgto de calefactor a tubo metálico (con conector rápido)
- 7- 9047 mgto doble de intercambiador en filtro de aceite
- 8- n/d mgto a caja mariposa y rebose botella
- 9- 3590 boquilla en bloque (plástico)
- 10- 9043 mgto de tubo metálico a botella
- 11- n/d mgto de caja mariposa a conector en mgto calefactor
- 12- 3604 conector mgto superior completo con accesorios
- 13- 3721 juego de conectores superior/inferior en mgto radiador
- 14- 3635 botella de expansión
- 15- 3573 tapón botella de expansión

## AUDI A3

<p><b>¡Nuevo!</b></p>  <p><b>9042</b> mgto de tubo metálico a calefactor r.o.</p>	<p><b>¡Nuevo!</b></p>  <p><b>9043</b> mgto de botella a tubo metálico r.o.</p>	<p><b>¡Nuevo!</b></p>  <p><b>9045</b> mgto inferior radiador r.o.</p>
<p><b>¡Nuevo!</b></p>  <p><b>9046</b> mgto superior radiador</p>	<p><b>¡Nuevo!</b></p>  <p><b>9047</b> mgto doble de intercambiador r.o.</p>	<p><b>¡Nuevo!</b></p>  <p><b>9048</b> mgto doble de intercambiador 1.6-1.8 r.o.</p>
<p><b>¡Nuevo!</b></p>  <p><b>9049</b> mgto doble de intercambiador 2.0 r.o.</p>	<p><b>¡Nuevo!</b></p>  <p><b>9050</b> mgto de culata a calefactor</p>	<p><b>¡Nuevo!</b></p>  <p><b>9051</b> mgto de culata a calefactor r.o.</p>
<p><b>¡Nuevo!</b></p>  <p><b>9053</b> mgto de calefactor a boquilla en culata r.o.</p>		

## AUDI A3

<p><b>¡Nuevo!</b></p>  <p><b>3176</b> tubo de agua metálico 1.6(8v) y 2.0 r.o.</p>	<p><b>¡Nuevo!</b></p>  <p><b>3177</b> tubo de agua metálico 1.8 r.o.</p>	<p><b>¡Nuevo!</b></p>  <p><b>3178</b> tubo de agua metálico 1.9TDi r.o.</p>
 <p><b>3592</b> tapa de termostato 1.9TDi /16v-1.6/16v,r.o.032121121J+032121110B</p>	 <p><b>3597</b> tapa de termostato 1.6(8v)-1.8-2.0 r.o.06A121121C-038121121D</p>	 <p><b>3598</b> tapa de agua en culata (lateral) 1.6(8v)-1.8 y 2.0,r.o.06A121132</p>
 <p><b>3604</b> kit completo empalme manguito superior radiador,r.o. 1J0121087A+accesorios</p>	 <p><b>3635</b> botella de expansión r.o. 1J0121403B</p>	 <p><b>3573</b> tapón botella de expansión r.o. 1J0121321B</p>
  <p><b>2669</b> junta válvula desvaporizadora r.o.028103500</p>	<p><b>¡Nuevo!</b></p>  <p><b>3721</b> juego conectores manguitos de radiador r.o.6Q0122291F+1J0122291</p>	
<p><b>¡Nuevo!</b></p>   <p><b>3722</b> tubo desvaporizador 1.9SDi-TDi r.o.038103493P</p>	<p><b>¡Nuevo!</b></p>   <p><b>3723</b> válvula desvaporizadora 1.9SDi-TDi r.o.028129101E</p>	<p><b>¡Nuevo!</b></p>  <p><b>3745</b> tapa con termostato 1.6 100-102 CV (motores APF-AVU),r.o.06A121114</p>





**CANALIZACIONES de AIRE de ALTA PRESION INTERCOOLER-TURBO:**

**OCTAVIA 1.9 Diesel TDi motores de 90 y 110CV**

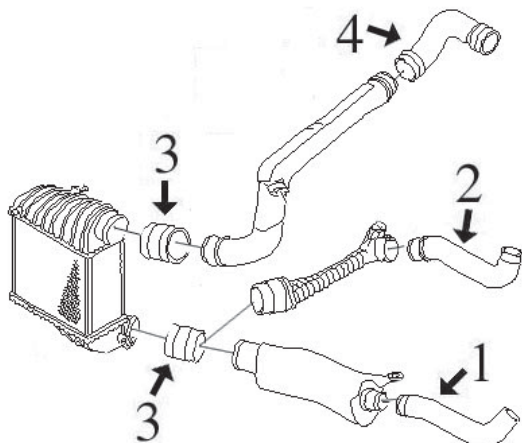

- 1- 9069 tubo flexible de empalme hasta 5/99
- 2- 9070 tubo flexible de empalme desde 5/99
- 3- 9064 tubo flexible de intercooler a tubo rígido
- 4- 9068 tubo flexible de tubo rígido a colector de aspiración

**OCTAVIA 1.9 Diesel TDi motores de 130 y 150CV**

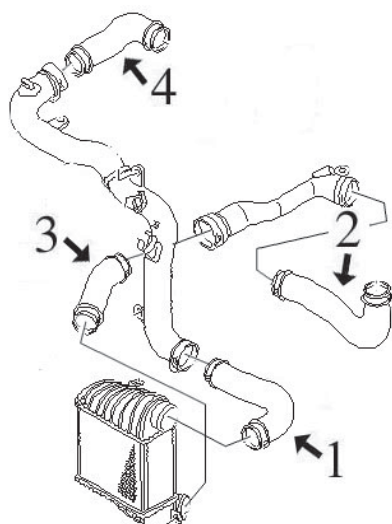

- 1- 9091 tubo flexible de intercooler a tubo, TDi de 150CV
- 9092 tubo flexible de intercooler a tubo, TDi de 130CV
- 2- n/d tubo flexible a intercooler
- 3- 9093 tubo flexible de intercooler a tubo, TDi de 150CV
- 9092 tubo flexible de intercooler a tubo, TDi de 130CV
- 4- 9094 tubo flexible de tubo rígido a colector de aspiración, TDi de 130CV

## AUDI A3

<p><b>¡Nuevo!</b></p>  <p><b>9064</b>  <math>\text{\O} 60 \times 70</math> largo 58 mm            tubo flexible de intercooler a tubo r3gido            r.o. 1J0145834A</p>	<p><b>¡Nuevo!</b></p>  <p><b>9068</b>            tubo flexible de tubo r3gido a colector            r.o. 1J0145838B</p>	<p><b>¡Nuevo!</b></p>  <p><b>9069</b>            tubo de empalme hasta 5/'99, 90-110CV            r.o. 1J0145828H</p>
<p><b>¡Nuevo!</b></p>  <p><b>9070</b>            tubo de empalme desde 5/'99, 90-110CV            r.o. 1J0145828T</p>	<p><b>¡Nuevo!</b></p>  <p><b>9091</b>            tubo de intercooler a tubo r3gido 150CV            r.o. 1J0145834AE</p>	<p><b>¡Nuevo!</b></p>  <p><b>9092</b>            tubo flexible de intercooler a tubo r3gido            r.o. 1J0145834AB</p>
<p><b>¡Nuevo!</b></p>  <p><b>9093</b>            tubo de intercooler a tubo r3gido 150CV            r.o. 1J0145834AA</p>	<p><b>¡Nuevo!</b></p>  <p><b>9094</b>            tubo de tubo r3gido a colector de aspiraci3n            r.o. 1J0145838AF</p>	

SUSPENSION DELANTERA y SOPORTES DE MOTOR:

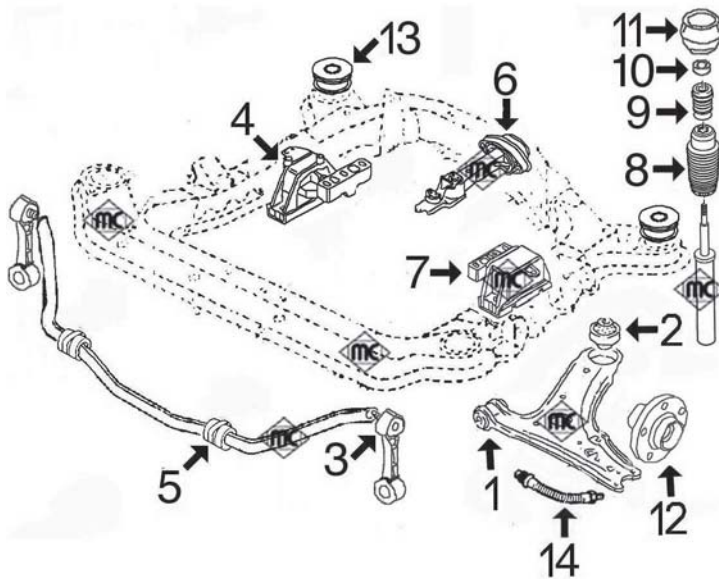

- 1- 542 silentbloc anterior trapecio delantero
- 2- 2963 silentbloc posterior trapecio delantero
- 3- 4250 bieleta puntal barra estabilizadora (plástico)
- 4249 bieleta puntal barra estabilizadora (metal)
- 4- 4368 soporte motor derecho 1.4-1.6 (105cv y 16v)-2.3V5
- 4186 soporte motor derecho 1.6 (100 y 102cv)-1.8-2.0 1.9SDi-1.9TDi
- 5- 4369 goma para barra estabilizadora de Ø 20 y 21 mm
- 4321 goma para barra estabilizadora de Ø 23 mm
- 6- 4133 soporte motor trasero
- 7- 4187 soporte motor izquierdo
- 8- 4324 capuchón amortiguador delantero
- 9- 4298 tope poliuretano amortiguador
- 10- 4128 rodamiento soporte amortiguador
- 11- 4177 soporte amortiguador completo con rodamiento
- 12- 90063 buje de rueda delantera
- 13- 4134 soporte sub-chasis trasero
- 14- 96013 latiguillo freno delantero (466 mm)

SUSPENSION TRASERA:

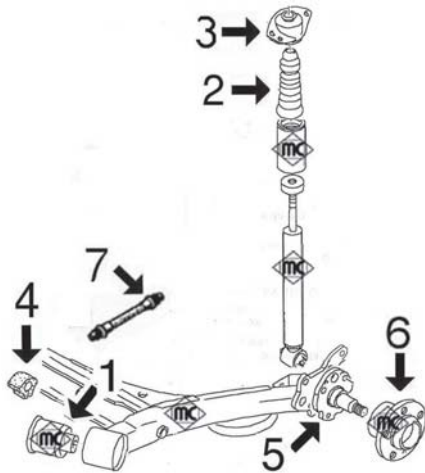

- 1- 4310 silentbloc brazo suspensión trasero
- 2- 4312 tope poliuretano amortiguador trasero
- 3- 4311 soporte amortiguador trasero
- 4- 2824 goma barra estabilizadora
- 5- n/d mangueta brazo trasero
- 6- 90521 buje rueda trasera
- 7- 96014 latiguillo freno trasero (180 mm)



**542**  
silentbloc anterior trapecio delantero  
r.o.357407182

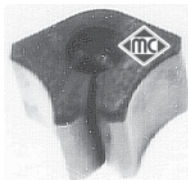

**2824**  
goma barra estabilizadora trasera  
r.o.871511423



**2963**  
silentbloc posterior trapecio delantero  
r.o.1J0407181



**4128**  
rodamiento soporte amortiguador delantero  
r.o.1J0412249



**4133**  
soporte motor trasero  
r.o.1J0199851AA



**4134**  
silentbloc sub-chasis trasero  
r.o.1J0199429

## AUDI A3



**4177**  
soporte amortiguador delantero completo  
conrodamiento, r.o. 1J0412331C

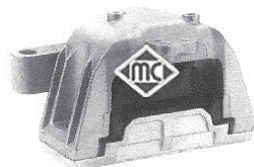

**4186**  
soporte motor derecho 1.6(100 y 102cv)-1.8-  
-2.0-1.9TDi-1.9SDi, r.o.



**4187**  
soporte motor izquierdo  
r.o. 1J0199555AJ/AK



**4249**  
bieleta puntal barra estabilizadora (metálica)  
r.o. 1J0411315G



**4250**  
bieleta puntal barra estabilizadora (plástico)  
r.o. 1J0411315C



**4298**  
tope poliuretano amortiguador delantero  
r.o. 1H0412303B



**4310**  
silentbloc brazo trasero suspensión  
r.o. 1J0501541C



**4311**  
soporte amortiguador trasero  
r.o. 1J0512353C



**4312**  
tope poliuretano amortiguador trasero  
r.o. 1J0512131-1J0512131B



**4321**  
goma para barra estabilizadora de Ø 23 mm  
r.o. 1J0411314G



**4324**  
capuchón amortiguador delantero  
r.o. 357413175A



**4368**  
soporte motor derecho 1.4-1.6 (de 105cv)  
-1.6/16v y 2.3V5, r.o. 1J0199262BK/BH



**4369**  
goma para barra estabilizadora de Ø 20 y  
21 mm, r.o. 1J0411314C



**90063**  
buje rueda delantera  
r.o. 1J0407613C



**90521**  
buje rueda trasera  
r.o. 1J0598477























**96013**  
latiguillo freno delantero (466 mm)  
r.o. 1J0611701



**96014**  
latiguillo freno trasero (180 mm)  
r.o. 6X0611775













## AUDI A3

<p><b>¡Nuevo!</b></p>  <p><b>4795</b> varilla nivel aceite 1.6/8v-1.8/20v y 2.0 r.o.</p>	<p><b>¡Nuevo!</b></p>  <p><b>4759</b> varilla nivel aceite 1.9TDi r.o.</p>	
 <p><b>3571</b> guía varilla nivel aceite 1.9TDi r.o.038103663</p>	 <p><b>3568</b> guía varilla nivel aceite 1.6/8v r.o.06A103663B</p>	 <p><b>3553</b> guía varilla nivel aceite 1.8/20v r.o.06A103663C</p>
 <p><b>3621</b> tapón llenado aceite motor (plástico, reemplaza al metálico), r.o.</p>	 <p><b>4365</b> juego tornillos sujeción tapa motor r.o.028103663G+90132603+028103937</p>	<p><b>¡Nuevo!</b></p>  <p><b>3720</b> tapa correa dsitribución 1.6-100CV r.o.06A109108S</p>
<p><b>¡Nuevo!</b></p>  <p><b>4421</b> polea cigüeñal 1.9TDi todos hasta '03 r.o.038105243</p>	<p><b>¡Nuevo!</b></p>  <p><b>4480</b> polea cigüeñal 1.9TDi desde '03- r.o.03G105243</p>	 <p><b>4405</b> polea cigüeñal 1.8-2.0 gasolina r.o.06A105243F</p>
<p><b>¡Nuevo!</b></p>  <p><b>3711</b> tubo de aire a caudalímetro 1.6-1.8 r.o. 1J0129684N</p>	<p><b>¡Nuevo!</b></p>  <p><b>3718</b> tubo de aire a caudalímetro 1.9Diesel r.o.</p>	<p><b>¡Nuevo!</b></p>  <p><b>3689</b> válvula filtro gasoil r.o. 1J0127247</p>
<p><b>¡Nuevo!</b></p>  <p><b>4749</b> casquillo guía embrague 1.8-1.9TDi-2.3 r.o. 02A141180A</p>	<p><b>¡Nuevo!</b></p>  <p><b>4772</b> leva embrague 1.4/16v-1.6/16v-1.6/8v-1.9SDi r.o.02K141709A</p>	<p><b>¡Nuevo!</b></p>  <p><b>3691</b> articulación cambio 1.9TDi hasta 5/'99 r.o. 1J0711256</p>
 <p><b>4326</b> bieleta reenvío cambio velocidades (excepto reenvío por cable), r.o. 1J0711183D</p>	 <p><b>4327</b> bieleta reenvío cambio velocidades (excepto reenvío por cable), r.o. 1J0711596E</p>	 <p><b>4328</b> bieleta reenvío cambio velocidades (excepto reenvío por cable), r.o. 1J0711803C</p>

## AUDI A3

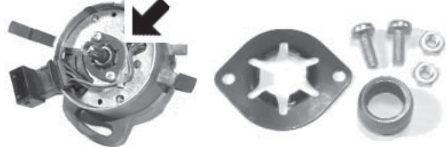
<p><b>¡Nuevo!</b></p>  <p><b>3720</b> tapa correa distribución 1.6(100CV) y 2.0 r.o.06A109108S</p>	<p><b>¡Nuevo!</b></p>  <p><b>5039</b> tensor correa alternador 1.9SDi r.o.038903315K</p>	<p><b>¡Nuevo!</b></p>  <p><b>5010</b> tensor correa alternador 1.6-1.8-2.0 r.o.06A903315E</p>
<p><b>¡Nuevo!</b></p>  <p><b>4767</b> <span style="float: right;">Ø 65 mm</span> rodillo tensor correa alternador 1.9D r.o.038145276</p>	<p><b>¡Nuevo!</b></p>  <p><b>4769</b> <span style="float: right;">Ø 75,5 mm</span> rodillo tensor correa alternador 1.9D r.o.038145278</p>	<p><b>¡Nuevo!</b></p>  <p><b>4770</b> tensor correa alternador 1.4-1.6 sin a/c r.o.030145299F</p>
<p><b>¡Nuevo!</b></p>  <p><b>4922</b> <span style="float: right;">Ø 17x70 mm</span> rodillo en tensor correa alternador 1.9D r.o.</p>	<p><b>¡Nuevo!</b></p>  <p><b>4968</b> <span style="float: right;">Ø 17x76 mm</span> rodillo en tensor correa alternador r.o.</p>	<p><b>¡Nuevo!</b></p>  <p><b>5009</b> tensor correa alternador 1.4-1.6 con a/c r.o.032145299A</p>
<p><b>¡Nuevo!</b></p>  <p><b>4944</b> tensor correa alternador 1.9TDi r.o.038903315C</p>	<p><b>¡Nuevo!</b></p>  <p><b>4997</b> <span style="float: right;">Ø 61 mm</span> polea de alternador de rueda libre r.o.022903119A</p>	<p><b>¡Nuevo!</b></p>  <p><b>4999</b> <span style="float: right;">Ø 61 mm</span> polea de alternador de rueda libre r.o.038903119</p>
 <p><b>1479</b> fuelle cremallera dirección r.o.1J0422831B</p>	 <p><b>1921</b> kit fuelle transm. l/rda 1.4-1.6(105cv)-1.6/16v y 1.9SDi (Ø 26-78 mm), r.o. 1J0498203</p>	 <p><b>1297</b> kit fuelle transm. l/rda. 1.6(100-102cv)-1.8- 2.0 y TDi de 90-100-110cv, (Ø 25-86 mm)</p>
 <p><b>1102</b> kit fuelle transmisión l/rueda TDi de 115-130- y 150cv (Ø 29-98 mm), r.o. 1J0498203A</p>	 <p><b>1106</b> kit fuelle transm. l/cambio 1.4-1.6(100-105cv) 1.6/16v y 1.9SDi (Ø 27-94 mm)</p>	 <p><b>1560</b> kit fuelle transm. izqda. l/cambio 1.8-2.0-1.6 (100-102cv) y 1.9TDi (Ø 21-100 mm)</p>
 <p><b>1637</b> kit fuelle transm. dcha. l/cambio 1.8-2.0-1.6 (100-102cv) y 1.9TDi (Ø 21-100 mm)</p>	 <p><b>1192</b> kit fuelle transmisión l/cambio 1.9TDi-1.8- 2.0 (Ø 27-100 mm), r.o. 6Q0498201A</p>	 <p><b>2308</b> kit fuelle transmisión l/cambio TDi 6 velcd. (Ø 22-107 mm), r.o.</p>

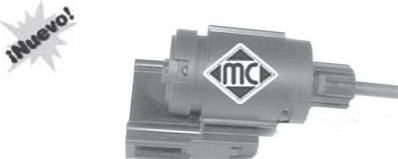
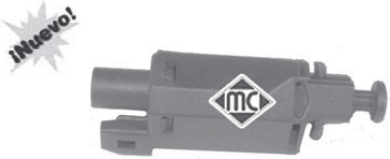
## AUDI A3

 <p><b>4121</b> soporte catalizador r.o. 1J0253144H</p>	 <p><b>4364</b> soporte catalizador r.o. 1H0253144E</p>	 <p><b>4122</b> soporte presilenciador 1.4-1.6 r.o. 1J0253144</p>
 <p><b>2426</b> soporte presilenciador 1.9TDi-1.9SDi r.o. 1H0253147B</p>	 <p><b>4123</b> soporte presilenciador 1.6-1.8-2.0 r.o. 1J0253144G</p>	 <p><b>4098</b> soporte silenciador trasero r.o. 1J0253144J</p>
 <p><b>3575</b> juego grapas plástico alzacristales r.o. (no hay despiece)</p>	 <p><b>4296</b> kit reparación distribuidor Magneti-Marelli 1.4-1.6 (casquillo sinterizado del eje rotor)</p>	 <p><b>2916</b> tapón cárter de aceite r.o. 90813201</p>
 <p><b>3738</b> interruptor luz de freno (4 polos) r.o. 1J0945511C/D</p>	 <p><b>3739</b> interruptor luz de freno (2 polos) r.o. 191945511A/B</p>	 <p><b>4248</b> tuerca rueda M14x1,5x27 r.o. 8D0601139D</p>
 <p><b>3708</b> tapón llenado combustible (sin llave) r.o.</p>		



SUSPENSION DELANTERA y SOPORTES DE MOTOR

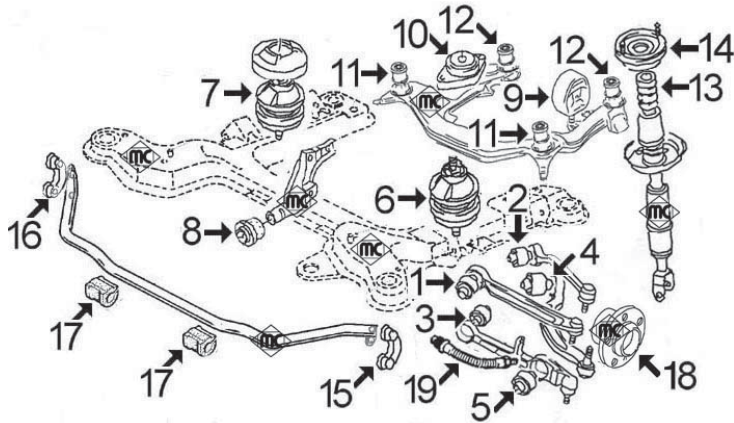

- 1- 4137 silentbloc interior brazo superior (anterior) suspensión delantera
- 2- 4137 silentbloc interior brazo superior (posterior) suspensión delantera
- 3- 4139 silentbloc interior brazo inferior (anterior) suspensión delantera
- 4- 4140 silentbloc interior brazo inferior (posterior) suspensión delantera
- 5- 4138 silentbloc exterior brazo inferior (anterior) suspensión delantera
- 6- 4130 soporte motor izquierdo motores de 4 cilindros  
4131 soporte motor izquierdo motores de 6 cilindros
- 7- 4132 soporte motor derecho motores de 4 cilindros  
4131 soporte motor derecho motores de 6 cilindros
- 8- 4359 silentbloc guia soporte motor delantero
- 9- 4135 soporte izquierdo cambio manual  
4136 soporte izquierdo cambio automático
- 10- 4136 soporte derecho cambio manual y automático
- 11- 4303 silentbloc anterior soporte sub-chasis cambio
- 12- 4304 silentbloc posterior soporte sub-chasis cambio
- 13- 4302 tope poliuretano amortiguador delantero
- 14- 4337 soporte amortiguador delantero
- 15- 4333 bieleta izquierda puntal barra estabiliz. hasta '97 (con tornillos)  
4143 bieleta izquierda puntal barra estabiliz. desde '97 (con agujeros pasantes)
- 16- 4334 bieleta derecha puntal barra estabiliz. hasta '97 (con tornillos)  
4146 bieleta derecha puntal barra estabiliz. desde '97 (con agujeros pasantes)
- 17- 4144 goma para barra estabilizadora de Ø 24 mm  
4145 goma para barra estabilizadora de Ø 27 mm
- 18- 90053 buje rueda delantera todos modelos salvo 1.9TDi con motor AFN y 2.8  
90054 buje rueda delantera 1.9TDi con motor AFN y 2.8
- 19- 96008 latiguillo freno delantero (310 mm)

 <p><b>4130</b> hidráulico soporte motor izquierdo motores de 4 cilindros, r.o. 8D0199379J/A/G/S</p>	 <p><b>4131</b> hidráulico soporte motor dcho. e izqdo. motores de 6 cilindros, r.o. 8D0199379K</p>	 <p><b>4132</b> hidráulico soporte motor derecho motores de 4 cilindros, r.o. 8D0199382L/M</p>
 <p><b>4135</b> soporte izquierdo cambio, (cambio manual) r.o. 8D0399151H</p>	 <p><b>4136</b> soporte derecho cambio, manual y automático, r.o. 8D0399151J/M</p>	 <p><b>4137</b> silentbloc brazos superiores suspensión lantera, r.o. 4D0407515C</p>
 <p><b>4138</b> silentbloc brazo inferior (anterior) suspensión delantera, r.o. 4D0407181H</p>	 <p><b>4139</b> silentbloc brazo inferior (anterior) suspensión delantera, r.o. 4D0407182E</p>	 <p><b>4140</b> silentbloc brazo inferior (posterior) suspensión delantera, r.o. 4D0407183P/Q/M</p>



## AUDI A4



**4143**

bieleta **izquierda** puntal barra estabilizador-  
r.o. 8D0411317D



**4144**

goma para barra estabilizadora de Ø 24 mm  
(berlina), r.o. 4D0411327G



**4145**

goma para barra estabilizadora de Ø 27 mm  
(Variant), r.o. 4D0411327H



**4146**

bieleta **derecha** puntal barra estabilizadora  
r.o. 8D0411318D



**4302**

tope poliuretano amortiguador delantero  
r.o. 8D0412131F



**4303**

silentbloc anterior soporte sub-chasis  
cambio, r.o. 8D0399415D



**4304**

silentbloc posterior soporte sub-chasis  
cambio, r.o. 8D0399419G



**4333**

bieleta **izquierda** puntal barra estabilizadora  
hasta '97, r.o. 4D0411317G



**4334**

bieleta **derecha** puntal barra estabilizadora  
hasta '97, r.o. 4D0411317J



**4337**

soporte amortiguador delantero  
r.o. 4D0412377F



**4359**

silentbloc guía soporte motor delantero  
r.o. 8D0199339F

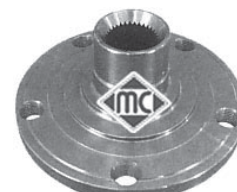

**90053**

**33 estrías**  
bujes rueda delantera todos modelos salvo  
1.9TDi (motor AFN) y 2.8, r.o. 8D0407615E



**90054**

**38 estrías**  
bujes rueda delantera 1.9TDi (AFN) y 2.8  
r.o. 4A0407615D



**96008**

latiguillo freno delantero (310 mm)  
r.o. 8D0611707



**96011**

latiguillo freno trasero (205 mm)  
r.o. 8D0611775E

**¡Nuevo!**



**96198**

latiguillo freno trasero (190 mm)  
r.o. 8E0611775J



**96002**

latiguillo freno trasero (225 mm)  
r.o. 8A0611775D



CANALIZACIONES de AIRE de ALTA PRESION INTERCOOLER-TURBO:

PASSAT-3 1.9 Diesel TDi motor de 100 CV:

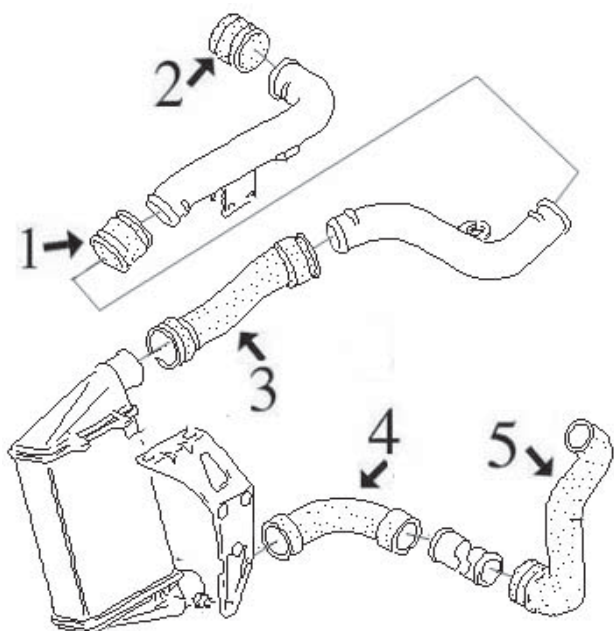

- 1- 9061 tubo flexible de empalme hasta 5/99
- 9071 tubo flexible de empalme desde 5/99
- 2- 9061 tubo flexible de empalme hasta 5/99
- 9071 tubo flexible de empalme desde 5/99
- 3- 9076 tubo flexible de empalme 90-100 CV
- 9077 tubo flexible de empalme 115 CV
- 4- 9075 tubo flexible de intercooler a tubo rígido (fijación con abrazaderas)
- 9074 tubo flexible de intercooler a tubo rígido (fijación con empalme rápido)
- 5- 9073 tubo flexible de tubo rígido a colector de aspiración (fijación con abrazaderas)
- 9072 tubo flexible de tubo rígido a colector de aspiración (fijación con empalme rápido)

<p><b>9061</b> tubo flexible de empalme hasta 5/99 r.o. 1H0145834E</p>	<p><b>9071</b> tubo flexible de empalme desde 5/99 r.o. 8D0145834A</p>	<p><b>9072</b> tubo flexible de tubo rígido a colector r.o. 8D0145828L</p>
<p><b>9073</b> tubo flexible de tubo rígido a colector r.o. 8D0145828G</p>	<p><b>9074</b> tubo flexible de intercooler a tubo rígido r.o. 3B0145834L</p>	<p><b>9075</b> tubo flexible de intercooler a tubo rígido r.o. 8D0145834F</p>
<p><b>9076</b> tubo flexible de empalme 90-100 CV r.o. 058145856A</p>	<p><b>9077</b> tubo flexible de empalme 115 CV r.o. 058145856K</p>	

## AUDI A4

 <p><b>2448</b> guía varilla nivel aceite 1.8 y 1.9 D d/ '99 r.o.053103663</p>	 <p><b>2876</b> guía varilla nivel aceite 1.6-1.9D hasta '99 r.o.028103663B</p>	 <p><b>3568</b> guía varilla nivel aceite 1.6 desde '99 r.o.06A103663B</p>
<p><i>¡Nuevo!</i></p>  <p><b>3725</b> guía varilla nivel aceite 1.6 r.o.06A103663A</p>	 <p><b>3571</b> guía varilla nivel aceite 1.6-1.8-2.0 r.o.038103663</p>	<p><i>¡Nuevo!</i></p>  <p><b>4759</b> varilla nivel de aceite 1.9D r.o.038115611B</p>
 <p><b>4365</b> jgo. tornillo sujeción tapa cubremotor r.o.028103665+028103937+028103638G</p>	<p><i>¡Nuevo!</i></p>  <p><b>4497</b> polea cigueñal 1.9TDi r.o.038105243F</p>	<p><i>¡Nuevo!</i></p>  <p><b>4498</b> polea cigueñal 1.9TDi r.o.028105243Q</p>
<p><i>¡Nuevo!</i></p>  <p><b>4496</b> polea cigueñal 2.0TDi r.o.03G105243B</p>	 <p><b>4405</b> polea cigueñal 1.6-1.8-2.0 r.o.06A105243E</p>	<p><i>¡Nuevo!</i></p>  <p><b>4945</b> tensor correa alternador 1.9TDi r.o.028903315N</p>
<p><i>¡Nuevo!</i></p>  <p><b>5044</b> tensor correa alternador 1.9TDi r.o.038903315D/P</p>	<p><i>¡Nuevo!</i></p>  <p><b>4769</b> rodillo tensor correa alternador 1.9TDi r.o.038145278</p>	<p><i>¡Nuevo!</i></p>  <p><b>4997</b>      <math>\varnothing</math> 61/55 mm, H=41 mm polea de alternador de rueda libre r.o.022903119A</p>
<p><i>¡Nuevo!</i></p>  <p><b>5002</b>      <math>\varnothing</math> 61/56 mm, H=35 mm polea de alternador de rueda libre r.o.022903119B</p>	<p><i>¡Nuevo!</i></p>  <p><b>5003</b>      <math>\varnothing</math> 61/56 mm, H=35 mm polea de alternador de rueda libre r.o.028903119T</p>	<p><i>¡Nuevo!</i></p>  <p><b>3672</b> válvula filtro gasoil hasta '99 r.o.191127247A</p>
<p><i>¡Nuevo!</i></p>  <p><b>3689</b> válvula filtro gasoil desde '99 r.o.1J0127247A</p>	<p><i>¡Nuevo!</i></p>  <p><b>3719</b> válvula desvaporizadora 1.9TDi r.o.028129101D</p>	 <p><b>3528</b> tapa termostato 1.6 - 1.8 (salvo motor 1.6AHL), r.o.030121121B</p>



## AUDI A4



**3601**  
tapa de termostato 1.6 (AHL)  
r.o.06B121121



**3593**  
tapa de termostato 1.9D-TDi  
r.o.



**3587**  
boquilla en culata (lateral) 1.9D-TDi  
r.o.



**3542**  
boquilla en culata (frontal) 1.9D-TDi  
r.o.028121132



**3566**  
boquilla en culata (lateral) 1.8  
r.o.028121132-058121133B



**3596**  
boquilla en culata (lateral) 1.6  
r.o.050121133C-050121132A



**3540**  
kit tapón sensores eléctricos en tapas agua  
r.o.357121140+032121142



**3623**  
botella de expansión hasta 11/00  
r.o.8D0121403L



**3729**  
botella de expansión desde 11/00  
r.o.8E0121403



**3573**  
tapón botella de expansión hasta 11/00  
r.o.8D0121403L



**3730**  
tapón botella de expansión desde 11/00  
r.o.8E0121321



**3708**  
tapón llenado combustible (sin llave)  
r.o.1J0201553C



**1187**  
kit fuelle transmisión lado rueda  
(Ø24-92mm),r.o.441498203A



**1297**  
kit fuelle transmisión lado rueda  
(Ø26-86mm),r.o.8D0498203A



**1560**  
kit fuelle transmisión l/cambio Ø 100 mm  
r.o.



**2308**  
kit fuelle transmisión l/cambio Ø 107 mm  
r.o.



**1300**  
fuelle izquierdo cremallera dirección  
r.o.4D0419831D



**1369**  
fuelle derecho cremallera dirección  
r.o.8D0419831J



**3737**  
interruptor luz de freno 2 polos (gasolina)  
r.o.443945515



**3735**  
interruptor luz de freno 4 polos (Diesel)  
r.o.4A0945515A



## AUDI A4

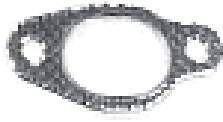

**2780**  
junta colector escape 1.9 D-TDi  
r.o.028129589B



**4123**  
soporte delantero escape  
r.o.1J0253144E



**2735**  
soporte trasero escape  
r.o.8D0253144R



**2736**  
soporte trasero escape  
r.o.8D0253144S



**4097**  
soporte trasero escape  
r.o.8D0253144M



**2737**  
tope silenciador  
r.o.



**2916**  
tapón cárter de aceite desde '97 (salvo V6)  
r.o.N90813201



**4248**  
tornillo rueda  
r.o.8D0601139D



**3621**  
tapón llenado aceite motor  
r.o.026103485

SUSPENSION DELANTERA y SOPORTES DE MOTOR

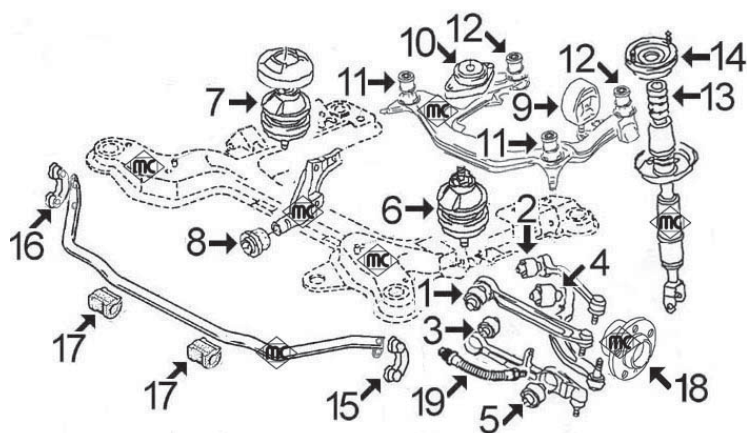

- 1- 4137 silentbloc interior brazo superior (anterior) suspensión delantera desde '97
- 2- 4137 silentbloc interior brazo superior (posterior) suspensión delantera desde '97
- 3- 4139 silentbloc interior brazo inferior (anterior) suspensión delantera desde '97
- 4- 4140 silentbloc interior brazo inferior (posterior) suspensión delantera desde '97
- 5- 4138 silentbloc exterior brazo inferior (anterior) suspensión delantera desde '97
- 6- 2485 soporte motor izquierdo hasta '97: 1.9D-2.0-2.5D  
n/d soporte motor izquierdo hasta '97: 2.4 - 2.8  
4130 soporte motor izquierdo desde '97: 1.8  
4132 soporte motor izquierdo desde '97: 1.9D  
4131 soporte motor izquierdo desde '97: 2.4 - 2.7 - 2.8  
n/d soporte motor izquierdo desde '97: 2.5D
- 7- 2485 soporte motor derecho hasta '97: 1.9D-2.0-2.5D  
n/d soporte motor derecho hasta '97: 2.4 - 2.8  
4132 soporte motor derecho desde '97: 1.8 - 1.9D  
4131 soporte motor derecho desde '97: 2.4 - 2.7 - 2.8  
n/d soporte motor derecho desde '97: 2.5D
- 8- 4359 silentbloc guia soporte motor delantero
- 9- n/d soporte izquierdo cambio hasta '97  
4135 soporte izquierdo cambio manual desde '97  
4136 soporte izquierdo cambio automático desde '97
- 10- n/d soporte izquierdo cambio hasta '97  
4136 soporte dcho. cambio manual y automático desde '97
- 11- 4303 silentbloc anterior soporte sub-chasis cambio
- 12- 4304 silentbloc posterior soporte sub-chasis cambio
- 13- 4302 tope poliuretano amortiguador delantero desde '97
- 14- 4337 soporte amortiguador delantero desde '97
- 15- 4143 bieleta izquierda puntal barra estabiliz. desde '97 (con agujeros pasantes)
- 16- 4146 bieleta derecha puntal barra estabiliz. desde '97 (con agujeros pasantes)
- 17- 4145 goma para barra estabilizadora de Ø 27 mm
- 18- 20054 buje de rueda delantera
- 19- 96008 latiguillo freno delantero desde '97



**2485** hidráulico  
soporte motor dcho. e izqd. hasta '97, 1.9D-2.0-2.5D, r.o. 4A0199379C/B/A/G



**4130** hidráulico  
soporte motor izquierdo 1.8 desde '97 r.o. 8D0199379J/A/G/S

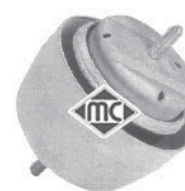

**4131** hidráulico  
soporte motor dcho. e izqdo. 2.4-2.7-2.8 desde '97, r.o. 8D0199379K



**4132** hidráulico  
soporte motor 1.8 - 1.9D desde '97 r.o. 8D0199382L/M



**4135**  
soporte izquierdo cambio, (cambio manual) desde '97, r.o. 8D0399151H

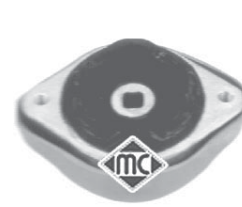

**4136**  
soporte dcho. cambio, manual y automático desde '97, r.o. 8D0399151J/M



**4137**  
silentbloc brazos superiores suspensión lantera desde '97, r.o. 4D0407515C















**4138**  
silentbloc brazo inferior (anterior) suspensión delantera desde '97, r.o. 4D0407181H



**4139**  
silentbloc brazo inferior (anterior) suspensión delantera d/ '97, r.o. 4D0407182E

## AUDI A6

 <p><b>4140</b> silentbloc brazo inferior (posterior) suspensión delantera desde '97, r.o. 4D0407183M/P</p>	 <p><b>4143</b> bieleta <b>izquierda</b> puntal barra estabilizador desde '97, r.o. 8D0411317D</p>	 <p><b>4145</b> goma para barra estabilizadora de Ø 27 mm desde '97, r.o. 4D0411327H</p>
 <p><b>4146</b> bieleta <b>derecha</b> puntal barra estabilizadora desde '97, r.o. 8D0411318D</p>	 <p><b>4302</b> tope poliuretano amortiguador delantero desde '97, r.o. 8D0412131F</p>	 <p><b>4303</b> silentbloc anterior soporte sub-chasis cambio, r.o. 8D0399415D</p>
 <p><b>4304</b> silentbloc posterior soporte sub-chasis cambio, r.o. 8D0399419G</p>	 <p><b>4337</b> soporte amortiguador delantero desde '97 r.o. 4D0412377F</p>	 <p><b>4359</b> silentbloc guía soporte motor delantero r.o. 8D0199339F</p>
 <p><b>90054</b> buje de rueda delantera r.o. 4A0407615D</p>	 <p><b>96008</b> latiguillo freno delantero desde '97 (310 mm) r.o. 8D0611707</p>	 <p><b>96011</b> latiguillo freno trasero (205 mm) r.o. 4B0611775</p>
 <p><b>96002</b> latiguillo freno trasero (225 mm) r.o. 8A0611775D</p>		

## AUDI A6



**3536**  
tapa de termostato 1.9 D hasta '97  
r.o.055121121F



**3517**  
boquilla en culata (lateral) 2.0 hasta '97  
r.o.026121145E



**3601**  
tapa de termostato 1.8 desde '97  
r.o.06B121121



**3528**  
tapa de termostato 1.6 desde '97  
r.o.



**3593**  
tapa de termostato 1.9D desde '97  
r.o.048121121B



**3586**  
boquilla en culata (lateral) 1.9D-TDi hasta '97,r.o.028121144M-028121145C



**3566**  
boquilla en culata (lateral) 1.8  
r.o.058121132-058121133B



**3587**  
boquilla en culata (lateral) 1.9D-TDi desde '97,r.o.028121144N-028121145G



**3542**  
boquilla en culata (frontal) 1.9 D-TDi  
r.o.028121132



**3522**  
boquilla en culata (frontal) 2.0 hasta '97  
r.o.037121132G-037121133K

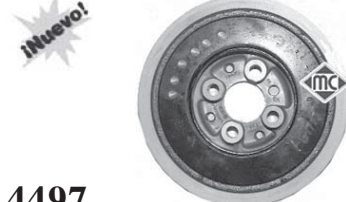

**4497**  
polea cigüeñal 1.9TDi  
r.o.038105243F

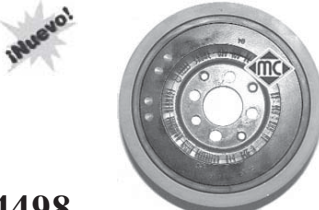

**4498**  
polea cigüeñal 1.9TDi  
r.o.028105243Q



**4496**  
polea cigüeñal 2.0TDi  
r.o.03G105243B



**4405**  
polea cigüeñal 1.6-1.8-2.0  
r.o.06A105243E



**4945**  
tensor correa alternador 1.9TDi  
r.o.028903315N



**5044**  
tensor correa alternador 1.9TDi  
r.o.038903315D/P



**4769**  
rodillo tensor correa alternador 1.9TDi  
r.o.038145278



**4997**      Ø 61/55 mm, H=41 mm  
polea de alternador de rueda libre  
r.o.022903119A



**5002**      Ø 61/56 mm, H=35 mm  
polea de alternador de rueda libre  
r.o.022903119B



## AUDI A6

<p><b>¡Nuevo!</b></p>  <p><b>5003</b> Ø 61/56 mm, H=35 mm polea de alternador de rueda libre r.o. 028903119T</p>	<p><b>¡Nuevo!</b></p>  <p><b>3672</b> válvula filtro gasoil hasta '99 r.o. 191127247A</p>	<p><b>¡Nuevo!</b></p>  <p><b>3689</b> válvula filtro gasoil desde '99 r.o. 1J0127247A</p>
<p><b>¡Nuevo!</b></p>  <p><b>3708</b> tapón llenado combustible (sin llave) r.o. 1J0201553C</p>	<p><b>¡Nuevo!</b></p>  <p><b>3719</b> válvula desvaporizadora 1.9TDi r.o. 028129101D</p>	 <p><b>3540</b> kit tapón sensores eléctricos en tapas agua r.o. 357121140+032121142</p>
 <p><b>3623</b> botella de expansión hasta 11/'00 r.o. 8D0121403L</p>	 <p><b>3573</b> tapón botella de expansión hasta 11/'00 r.o. 8D0121403L</p>	<p><b>¡Nuevo!</b></p>  <p><b>3729</b> botella de expansión desde 11/'00 r.o. 8E0121403</p>
<p><b>¡Nuevo!</b></p>  <p><b>3730</b> tapón botella de expansión desde 11/'00 r.o. 8E0121321</p>	<p><b>¡Nuevo!</b></p>  <p><b>3737</b> interruptor luz de freno 2 polos (gasolina) r.o. 443945515</p>	<p><b>¡Nuevo!</b></p>  <p><b>3735</b> interruptor luz de freno 4 polos (Diesel) r.o. 4A0945515A</p>
 <p><b>2448</b> guía varilla nivel aceite 1.8 y 1.9D desde '97 r.o. 053103663</p>	 <p><b>2876</b> guía varilla nivel aceite 1.9 hasta '97 r.o. 028103663B</p>	<p><b>¡Nuevo!</b></p>  <p><b>3621</b> tapón llenado aceite motor r.o. 06A103485F</p>
 <p><b>1732</b> kit fuelle transmisión l/ rueda (Ø22-81 mm) r.o. 8D0121403B</p>	 <p><b>1187</b> kit fuelle transmisión l/ rueda (Ø24-92 mm), r.o. 441498203A</p>	 <p><b>1297</b> kit fuelle transmisión lado rueda (Ø26-86 mm), r.o. 8D0498203A</p>
 <p><b>1560</b> kit fuelle transmisión l/cambio Ø 100 mm r.o.</p>	 <p><b>2308</b> kit fuelle transmisión l/cambio Ø 107 mm r.o.</p>	

## AUDI A6



**1772**  
fuelle cremallera dirección  
r.o.431419831

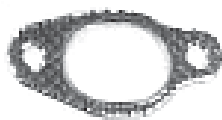

**2780**  
junta colector escape 1.9 D-TDi  
r.o.028129589B



**2766**  
soporte escape hasta '97  
r.o.4A0253147A



**366**  
soporte escape hasta '97  
r.o.893253147A



**4123**  
soporte delantero escape desde '97  
r.o.1J0253144E



**2735**  
soporte trasero escape desde '97  
r.o.8D0253144R



**4097**  
soporte trasero escape desde '97  
r.o.8D0253144M



**4248**  
tornillo rueda  
r.o.



**674**  
tapón cárter de aceite hasta '97  
r.o.N90288901



**2916**  
tapón cárter de aceite desde '97 (salvo V6)  
r.o.N90813201



**4365**  
jgo. tornillo sujeción tapa cubremotor  
r.o.028103665+028103937+028103638G

SUSPENSION DELANTERA y SOPORTES DE MOTOR

serie 3 E30 de '82 a '91

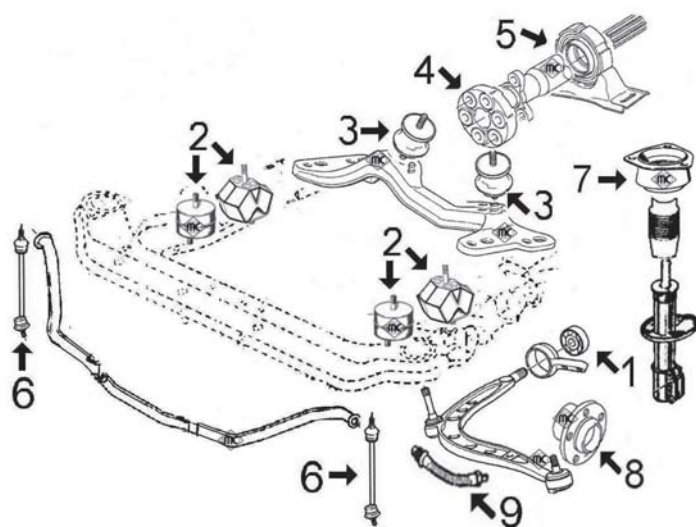

- 1- 2891 silentbloc trapecio delantero
- 2- 4191 soporte motor 316-318  
4190 soporte motor 320-323-324d-325
- 3- 4188 soporte cambio manual 316-318  
4189 soporte cambio manual 320-323-324d-325  
4224 soporte cambio automático
- 4- 925 flector de transmisión Ø 108 mm  
926 flector de transmisión Ø 132 mm
- 5- 4225 soporte árbol de transmisión con rodamiento
- 6- 4339 bieleta puntal barra estabilizadora
- 7- 4229 soporte amortiguador delantero con rodamiento
- 8- 90057 buje rueda delantera (4 agujeros)
- 9- n/d latiguillo freno delantero

serie 3 E36 de '91 a '98

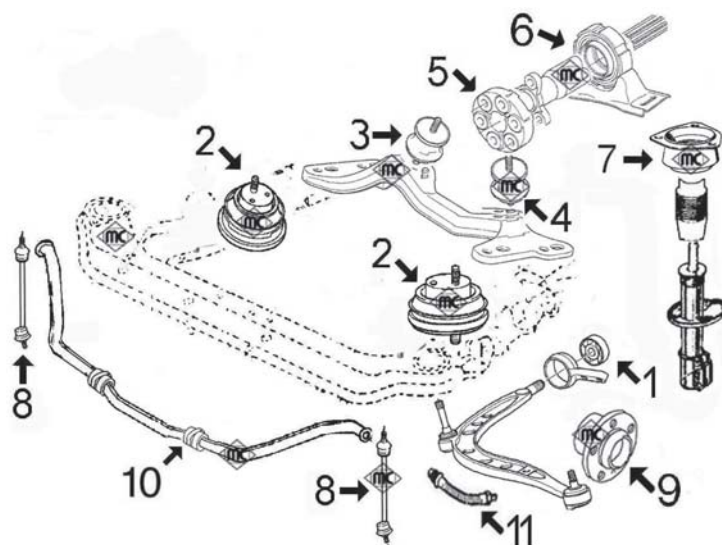

- 1- 2892 silentbloc trapecio delantero
- 2- 2676 soporte motor (hidráulico)
- 3- 4192 soporte dcho. cambio manual 316-318  
4188 soporte dcho. cambio manual 320-325  
4349 soporte dcho. cambio autom 320-325 desde 4/'93
- 4- 4192 soporte izqd. cambio manual 316-318  
4188 soporte izqd. cambio manual 320-325  
4348 soporte izqd. cambio autom 320-325 desde 4/'93
- 5- 926 flector de transmisión Ø 132 mm  
927 flector de transmisión Ø 111 mm
- 6- 4251 soporte árbol de transmisión con rodamiento
- 7- 4229 soporte amortiguador delantero con rodamiento
- 8- 4263 bieleta puntal barra estabilizadora
- 9- 90057 buje rueda delantera de 4 agujeros  
90056 buje rueda delantera de 5 agujeros
- 10- 5073 goma barra estabilizadora (Ø 24 mm)
- 11- 96005 latiguillo freno delantero (425 mm)

serie 3 E46 de '98 a '05

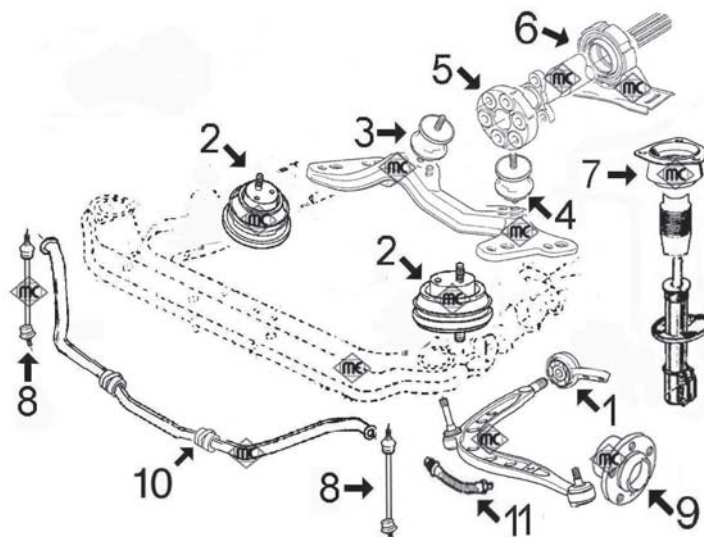

- 1- 4255 jgo silentblocs reparación trapecios delanteros (derecho+izquierdo)
- 2- 4780 soporte motor 316i-318i-318d-320d  
2676 soporte motor 320i-323i-325i-328i-330i
- 3- 4192 soporte dcho. cambio 316-318-320  
4188 soporte dcho. cambio 320-325
- 4- 4192 soporte izqd. cambio 316-318  
4188 soporte izqd. cambio 320-325
- 5- 926 flector de transmisión Ø 132 mm  
927 flector de transmisión Ø 111 mm  
4346 flector de transmisión Ø 154 mm  
4347 flector de transmisión Ø 143 mm  
4407 flector de transmisión Ø 135 mm
- 6- 4251 soporte árbol de transmisión con rodamiento
- 7- 4228 soporte amortiguador delantero con rodamiento
- 8- 4341 bieleta puntal barra estabilizadora
- 9- 90057 buje rueda delantera (5 agujeros)
- 10- 5072 goma barra estabilizadora (Ø 24,5 mm)
- 11- 96021 latiguillo freno delantero (405 mm)



serie 5 E34 de '87 a '95

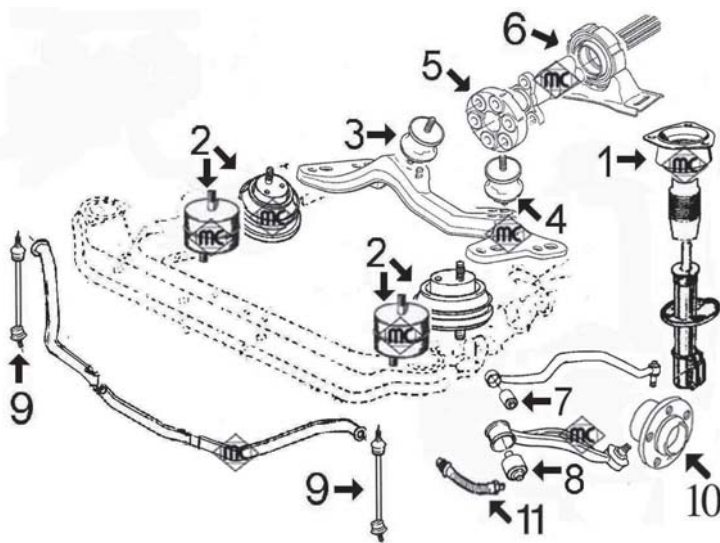

- 1- 4229 soporte amortiguador delantero con rodamiento
- 2- 4223 soporte motor 518-520-525
- 2776 soporte motor 524d-528-530-535
- 3- 4188 soporte dcho. cambio manual 518-524-528-530-535
- 4349 soporte dcho. cambio manual 520-525
- 4- 4188 soporte dcho. cambio manual 518-524-528-530-535
- 4348 soporte dcho. cambio manual 520-525
- 5- 925 flector de transmisión Ø 108 mm
- 926 flector de transmisión Ø 132 mm
- 927 flector de transmisión Ø 111 mm
- 4346 flector de transmisión Ø 154 mm
- 4347 flector de transmisión Ø 143 mm
- 6- 4225 soporte árbol de transmisión con rodamiento
- 7- 4252 silentbloc brazo posterior
- 8- 4226 silentbloc brazo anterior
- 9- 4263 bieleta puntal barra estabilizadora
- 10- 90057 buje rueda delantera (5 agujeros)
- 11- 96027 latiguillo freno delantero (420 mm)

serie 5 E39 de '95 a '04

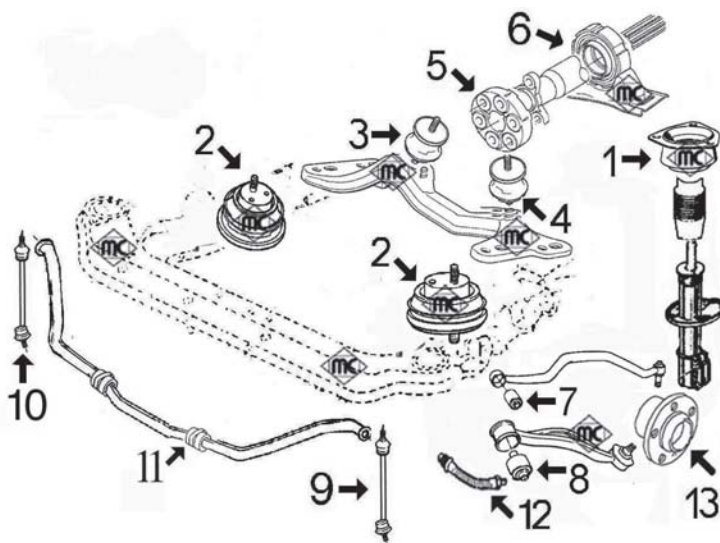

- 1- 4228 soporte amortiguador delantero con rodamiento
- 2- 4881 soporte motor 520i-523i-528i-530i
- 5069 soporte motor 525td-tds
- 4879 soporte motor derecho 535i-540i
- 4880 soporte motor izquierdo 535i-540i
- 3- 4188 soporte dcho. cambio 518-528-530-535
- 4349 soporte dcho. cambio 520-525
- 4- 4188 soporte dcho. cambio 518-528-530-535
- 4348 soporte dcho. cambio 520-525
- 5- 926 flector de transmisión Ø 132 mm
- 927 flector de transmisión Ø 111 mm
- 4346 flector de transmisión Ø 154 mm
- 4347 flector de transmisión Ø 143 mm
- 4407 flector de transmisión Ø 135 mm
- 6- 4251 soporte árbol de transmisión con rodamiento
- 7- 4227 silentbloc brazo posterior todos salvo 535i-540i-M5
- 4253 silentbloc brazo posterior 535i-540i-M5
- 8- 4226 silentbloc brazo anterior
- 9- 4343 bieleta derecha puntal barra estabilizadora
- 10- 4342 bieleta izquierda puntal barra estabilizadora
- 11- 5074 goma barra estabilizadora (Ø 22,5 mm)
- 12- 96034 latiguillo freno delantero (405 mm)
- 13- 90057 buje rueda delantera (5 agujeros)

SUSPENSION TRASERA serie 3 E36 (desde '91-'98) y E46 (desde '98-):

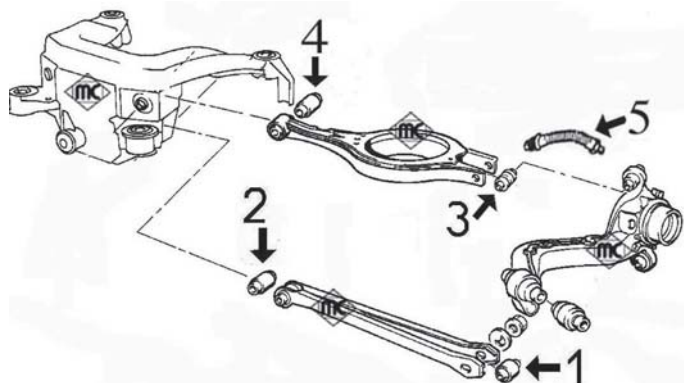

- 1- 4257 silentbloc exterior tirante transversal trasero
- 2- 4258 silentbloc interior tirante transversal trasero
- 3- 5071 silentbloc conexión brazo suspensión y mangueta
- 4- 5070 silentbloc interior brazo suspensión trasero
- 5- 96006 latiguillo freno trasero E36 freno de tambor
- 96019 latiguillo freno trasero E36 freno de disco
- 96025 latiguillo freno trasero E36 ABS+ASC
- 96025 latiguillo freno trasero E46



**B M W**

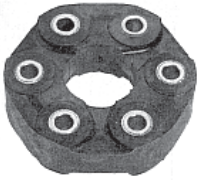

**925** Ø ext. 108 mm- Ø montaje 78 mm  
flector de transmisión series 3 - 5 y Z3(1.9)  
r.o.26111227869



**926** Ø ext. 132 mm- Ø montaje 96 mm  
flector de transmisión series 3 - 5 y 7  
r.o.26111209168

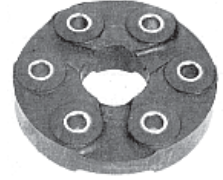

**927** Ø ext. 110 mm- Ø montaje 78 mm  
flector de transmisión serie 3 y 5 y Z3  
r.o.26111227410-



**2676** altura cuerpo 68 mm  
soporte motor serie 3  
r.o.11811141377-11811141889-11811140985



**2776** altura cuerpo 65 mm  
soporte motor series 5 y 7  
r.o.11811139606-11811139019



**2891**  
silentbloc trapecio delantero serie 3 '83-'91  
r.o.31129058815(31121127378)



**2892**  
silentbloc trapecio delt. serie 3 de '91a '98  
r.o.31129059288 (18x60x33)



**4188**  
soporte cambio series 3 y 5  
Ø50/36M-8,r.o.23701141614-23711137817



**4189**  
soporte cambio serie 3 hasta '91  
r.o.23711175939



**4190**  
soporte motor serie 3, tornillos centrados  
Ø65 mm, M-8,r.o.11811132321



**4191**  
soporte motor serie 3 hasta '91  
r.o.11811129286



**4192**  
soporte cambio serie 3  
Ø50/47 altura 70M-8,r.o.23701138517



**4223**  
soporte motor serie 5, tornillos descentrados  
Ø65 mm, M-8,r.o.11811133364



**4224**  
soporte cambio serie 3 automáticos hasta '91  
r.o.24711128372

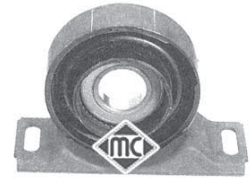

**4225**  
soporte transmisión Ø 30 con rodamiento  
series 3 y 5, r.o.26121226723



**4226**  
silentbloc brazo anterior delantero serie 5  
r.o.31121124622



**4227**  
silentbloc brazo posterior delantero serie 5  
hasta '95,r.o.31129068753



**4228**  
soporte amortiguador delantero series 3 y 5  
con rodamiento,r.o.31331094616



**4229**  
soporte amortiguador delantero series 3 y 5  
con rodamiento,r.o.31331139452-31331092885



**4251**  
soporte transmisión series 3 y 5 con roda-  
miento,r.o.26121226731-26127501257



**4252** **hidráulico**  
silentbloc brazo posterior delantero serie 5  
hasta '95,r.o.31121136605-31121139456

# B M W



**4253** **hidráulico**  
silentbloc brazo posterior delt. serie 5 desde '95, r.o. 31129071085



**4255**  
jgo silentblocs reparación trapecios delanteros serie 3 desde '98 E46, r.o. 31126757623



**4257**  
silentbloc exterior tirante inferior **trasero** s/3 r.o. 33321136611



**4258**  
silentbloc interior tirante inferior **trasero** s/3 r.o. 33321138383



**4339**  
bieleta puntal barra estabilizadora serie 3 hasta '91, r.o. 31351091764



**4263**  
bieleta puntal barra estabilizadora serie 3 E36 y serie 5 E34, r.o. 31351134582



**4341**  
bieleta puntal barra estabilizadora serie 3 E46 r.o. 31351095694



**4342** **izquierda**  
bieleta puntal barra estabilizadora serie 5 E39, r.o. 313610098155-31351095661



**4343** **derecha**  
bieleta puntal barra estabilizadora serie 5 E39, r.o. 313610098156-31351095662



**4346** Ø ext. 154 mm- Ø montaje 110 mm  
flector transmisión serie 3 E36, serie 5 E39 y serie 7, r.o. 26111229754

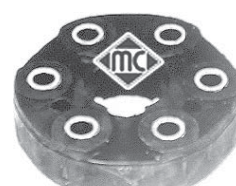

**4347** Ø ext. 143 mm- Ø montaje 105 mm  
flector transmisión serie 3 E36, serie 5 E34 y E39 y serie 7, r.o. 26111229065



**4348**  
soporte izquierdo cambio series 3 y 5 r.o. 24701138427



**4349**  
soporte derecho cambio series 3 y 5 r.o. 24701138428



**4407** Ø ext. 135 mm- Ø montaje 96 mm  
flector transmisión series 3 y 5 E46/E39 r.o. 26117511454-2611109168

**¡Nuevo!**



**4780** **altura cuerpo 70 mm**  
soporte motor s/3 E46 ('98-) r.o. 22111094813

**¡Nuevo!**



**4879**  
soporte motor derecho E39 535i-540i r.o. 22111092826-22111141792

**¡Nuevo!**



**4880**  
soporte motor izquierdo E39 535i-540i r.o. 22111092823

**¡Nuevo!**



**4881**  
soporte motor E39 520i-523i-525i-530i r.o. 22116754608-22111094073

**¡Nuevo!**





**5069**  
soporte motor derecho E39 525td-tds r.o. 22111094248

**¡Nuevo!**



**5070**  
silentbloc interior brazo suspensión trasero r.o. 33321092247 (Ø12x36 mm, largo 67 mm)

# B M W

<p><b>¡Nuevo!</b></p>  <p><b>5071</b> silentbloc conexión brazo trasero a mangueta, r.o.33321140345 (Ø12x45, largo 57)</p>	<p><b>¡Nuevo!</b></p>  <p><b>5072</b> goma barra estabilizadora s/3 E46 ('98-'05) (Ø24,5 mm), r.o. 31351095271</p>	<p><b>¡Nuevo!</b></p>  <p><b>5073</b> goma barra estabilizadora s/3 E36 ('90-'98) (Ø24 mm), r.o. 31351090263</p>
<p><b>¡Nuevo!</b></p>  <p><b>5074</b> goma barra estabilizadora s/5 E39 ('95-'04) (Ø22,5 mm), r.o. 31351093108</p>	<p><b>90056</b> bujes rueda delantera serie 3 con rueda de <b>4 agujeros</b>, r.o. 31 21 1 131 297</p> 	<p><b>90057</b> bujes rueda delantera series 3-5-7 con rueda da de <b>5 agujeros</b>, r.o. 31 22 1 139 345</p> 
 <p><b>1538</b> fuelle dcho. cremallera manual serie 3 r.o.321111117426</p>	 <p><b>1539</b> fuelle izqd. cremallera manual serie 3 r.o.321111118688</p>	 <p><b>1305</b> fuelle cremallera asistida series 3 y 5 r.o.3221139786-32131092876</p>
 <p><b>1510</b> (bocas Ø 24 y 58 mm) kit reparación transmisión series 3 y 5 r.o.33211208443</p>	<p><b>¡Nuevo!</b></p>  <p><b>1150</b> (bocas Ø 30 y 44 mm) kit reparación transmisión series 3 y 5 r.o.33211229590</p>	<p><b>¡Nuevo!</b></p>  <p><b>3747</b> tapón llenado aceite motor r.o.11121743294</p>
 <p><b>3580</b> tapón botella de expansión <b>2,00 bar</b> r.o.17111742231</p>	<p><b>¡Nuevo!</b></p>  <p><b>3707</b> tapón botella de expansión <b>1,40 bar</b> r.o.17111742232</p>	 <p><b>3581</b> botella de expansión con tapón serie 3 E36 ('91-'98), r.o.17111723520</p>
<p><b>¡Nuevo!</b></p>  <p><b>3749</b> tapa de termostato series 3/5 motores 2.0i-2.3i-2.5i, r.o. 11531722531</p>	<p><b>¡Nuevo!</b></p>  <p><b>4889</b> Ø 153 mm - 5 canales polea cigueñal Diesel r.o. 1123 2246511</p>	<p><b>¡Nuevo!</b></p>  <p><b>5075</b> Ø 10x70 mm, ancho 24,5 mm rodillo tensor correa alternador motores 2.0i-2.3i-2.5i series 3 y 5, r.o. 11281748131</p>
<p><b>¡Nuevo!</b></p>  <p><b>5076</b> Ø 80 mm, ancho 24,5 mm rodillo tensor correa alternador motores 2.0i-2.3i-2.5i series 3 y 5, r.o. 11281748131</p>	<p><b>¡Nuevo!</b></p>  <p><b>5077</b> tensor correa alternador serie 3 E36-E46 316i-318i, r.o. 112814232104</p>	<p><b>¡Nuevo!</b></p>  <p><b>5078</b> tensor correa alternador series 3/5 E39-E46 motores 2.0i-2.3i-2.5i, r.o. 112811433571</p>

**B M W**



**2745**

soporte escape serie 5  
r.o. 18211745426



**2746**

soporte escape serie 5  
r.o. 18211745350



**2747**

soporte escape serie 3 modelo '95  
r.o. 18211723101



**2416**

soporte tubo de escape serie 3  
r.o. 18301703634



**2430**

soporte tubo de escape serie 3  
r.o. 18211176424



**090**

soporte tubo de escape serie 3 hasta '91  
r.o. 1821105638-18211105677

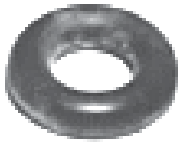

**366**

soporte tubo de escape serie 3  
r.o. 18211245113



**678**

tapón cárter de aceite  
r.o. 11131273093



**4230**

cubrepedal freno y embrague (cambio ma-  
nual), r.o. 35211160422



**2785**

soporte filtro de aire series 3 y 5  
(Ø30mm, altura 15mm), r.o. 13711259818



## CITROËN 2CV - DYANE - CX



**1569**

kit fuelle l/rueda transmisión de cruceta  
2 CV - Dyane - Mehari, r.o. AM 373 99



**1570**

kit fuelle intermedio transm. de cruceta  
2 CV - Dyane - Mehari, r.o. AM 372 88A



**1571**

kit fuelle l/cambio transmisión de cruceta  
2 CV - Dyane - Mehari, r.o. AZ 373 88A



**1363**

kit fuelle transmisión l/rueda  
r.o. 5420024

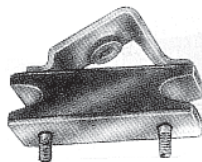

**402**

soporte motor 2 CV - Dyane - Visa 652 cc  
r.o. 95587825

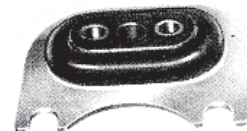

**403**

soporte cambio 2 CV - Dyane - Mehari  
r.o. AM 1331 A



**673**

tapón cárter 2 CV - Dyane - GS (16x150)  
r.o.

## CANALIZACIONES DE AGUA:

AX 1.1 y 1.4 gasolina  
 AX 1.4 Diesel (TUD3) hasta PR-5804 (10/'92)  
 AX 1.4 Diesel (TUD3) desde PR-5805 (10/'92)  
 AX 1.5 Diesel (TUD5)

### AX gasolina motores 1.1 y 1.4 TU

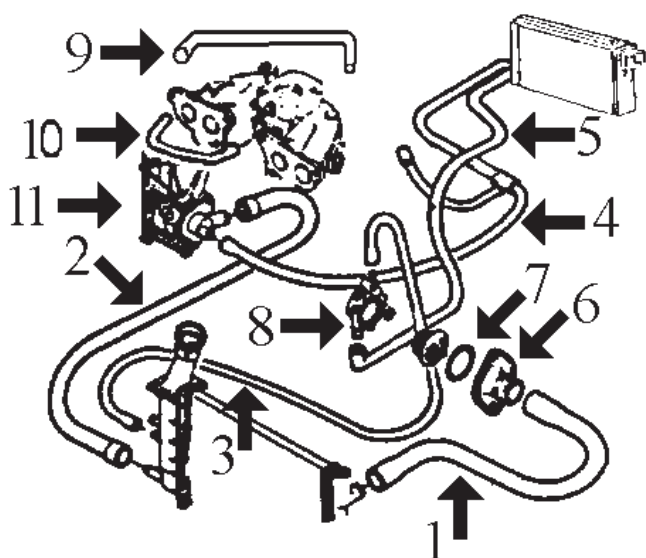

- 1- 7854 mgto superior de radiador
- 2- 7834 mgto inferior de radiador
- 3- 7950 mgto degasificador, de radiador a tapa termost.
- 4- 8082 mgto calefactor a bomba y carburador hasta '90  
(3 vias, ver foto)
- 7941 mgto calefactor (1er. tramo) desde '90 (ver foto)
- 8343 mgto calefactor (2º tramo) desde '90 (ver foto)
- 5- 7817 mgto calefactor a tapa termostato
- 6- 3011 boquilla alojamiento termostato
- 7- 2351 junta de termostato
- 8- 3081 boquilla metálica inferior en caja termostato
- 3082 boquilla metálica superior en caja termostato
- 9- 7952 mgto de carburador a colector de admisión \*
- 10- 7953 mgto de carburador a colector admisión 1.1 \*
- 7954 mgto de carburador a colector admisión 1.4 \*
- 11- 3578 tapa bomba de agua

\* excepto versiones de inyección

mgto. desvaporizadores: MC-8167 y MC-8002

### AX 1.4 Diesel hasta PR-5804 (10/'92)

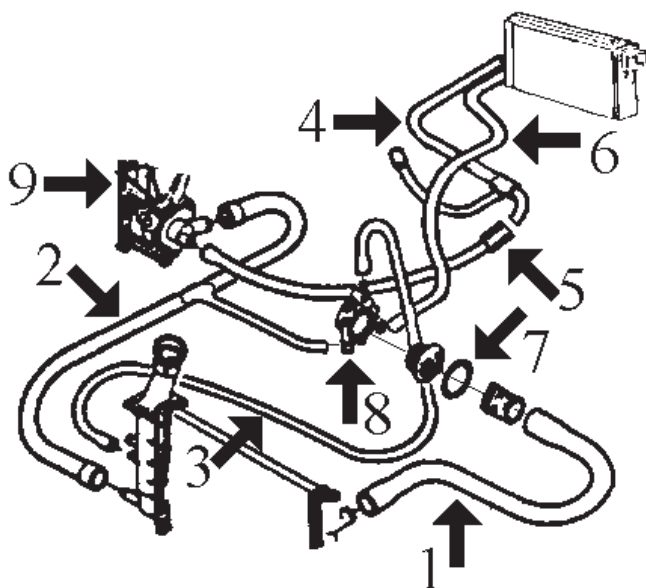

- 1- 8042 mgto superior de radiador
- 2- 8043 mgto inferior de radiador (3 vias)
- 3- 7950 mgto de radiador a caja de termostato
- 4- 8061 mgto de calefactor a racor con derivación para purgador (3 vias, 1er. tramo)
- 5- 8329 mgto de bomba a racor empalme con mgto de calefactor (2º tramo de calefactor)
- 6- 8075 mgto de calefactor a culata
- 7- 3132 tapa de termostato
- 2352 junta de termostato
- 8- 3081 boquilla metálica inferior en caja termostato
- 3082 boquilla metálica superior en caja termostato
- 9- 3578 tapa bomba de agua

mgto. desvaporizador: MC-8324

## AX 1.4 Diesel desde PR-5805 (10/'92)

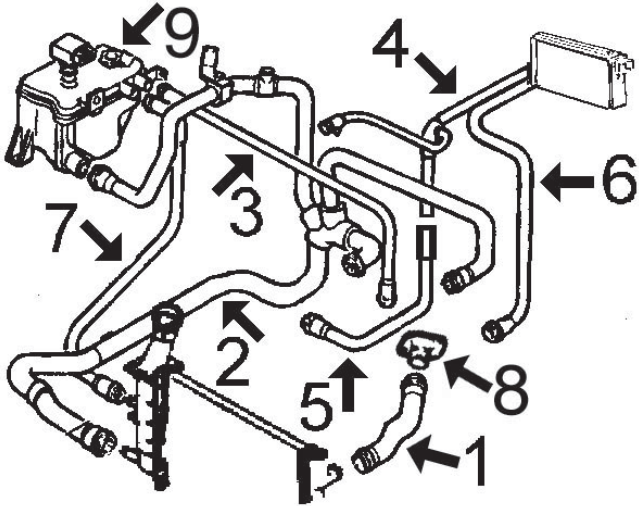

- 1- 8042 mgto superior radiador
- 2- 8322 mgto inferior radiador
- 3- 8323 mgto de botella a caja de termostato
- 4- 8061 mgto de calefactor, 1er. tramo
- 5- 8329 mgto de calefactor, 2º tramo
- 6- 8075 mgto de calefactor a culata
- 7- 8323 mgto de botella a radiador
- 8- 3132 tapa de termostato
- 3077 boquilla en caja termostato
- 3078 boquilla en caja termostato
- 9- 3643 botella de expansión
- 3548 tapón botella expansión 1.4 bar

mgto desvaporizador: MC-8324

## AX 1.5 Diesel

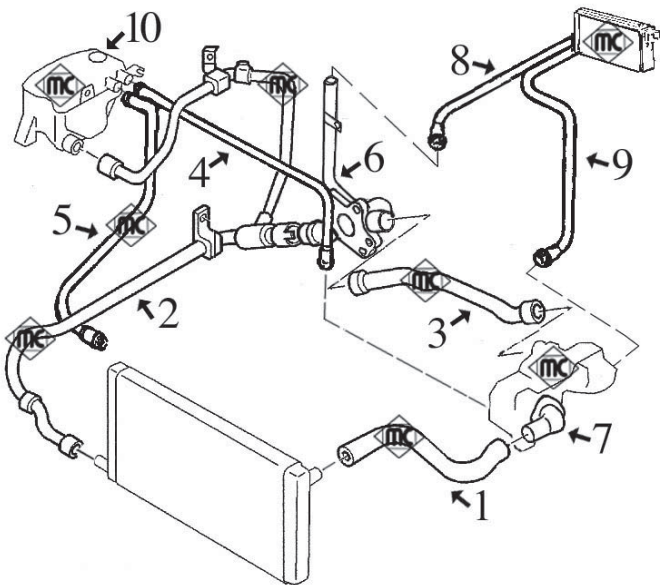

- 1- 8042 mgto superior radiador
- 2- 8512 mgto inferior radiador
- 3- 8511 mgto de tubo metálico a caja termostato
- 4- 8510 mgto de botella a caja termostato
- 5- 8323 mgto de botella a radiador
- 6- 3133 tubo de agua metálico
- 7- 3132 tapa de termostato
- 8- 8513 mgto de calefactor a tubo metálico
- 9- 8514 mgto de calefactor a caja termostato
- 10- 3643 botella de expansión
- 3548 tapón botella expansión 1.4 bar



## AX 1.5 Diesel, desvaporizadores:

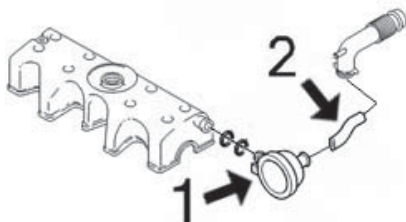

- 1- 3655 válvula desvaporizadora con juntas tóricas
- 2- 8533 mgto de válvula desvaporizadora a filtro aire

## CITROËN AX



**7817**  
mgto de caja termostato a calefact. 1.1-1.4  
r.o. 95637678



**7834**  
mgto inferior radiador 1.1-1.4 gasolina  
r.o. 96022712



**7854**  
mgto superior radiador 1.1-1.4 gasolina  
r.o. 95636003



**7941**  
mgto calefactor 1er. tramo desde '90  
r.o. 96014856



**7950**  
mgto de radiador a caja termost. 1.1-1.4-D  
r.o. 95637680



**7952**  
mgto de carburador a colector 1.1-1.4  
(salvo inyección), r.o. 95636723 - 1413.95



**7953**  
mgto de carburador a colector 1.1  
r.o. 97533257



**7954**  
mgto de carburador a colector 1.4  
r.o. 97533256 - 1413.94



**8002**  
mgto desvaporizador 1.1-1.4 gasolina  
r.o. 1191.13 - 1191.21 - 1192.62



**8042**  
mgto superior radiador Diesel  
r.o. 96003397



**8043**  
mgto inferior radiador 1.4 Diesel hasta '92  
r.o. 96003400



**8061**  
mgto de calefactor a bomba 1.4 Diesel  
r.o. 96159736



**8075**  
mgto de calefactor a culata 1.4 Diesel  
r.o. 6464.R9



**8082**  
mgto de calefactor a bomba 1.1 - 1.4 gaso-  
lina hasta '90, r.o. 96058716



**8167**  
mgto desvaporizador 1.1-1.4 gasolina  
r.o. 1192.69 - 1192.61

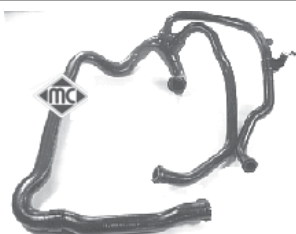

**8322**  
mgto inferior radiador 1.4 Diesel desde '92  
r.o. 96173039



**8323**  
mgto de botella a culata y radiador Diesel  
desde '93, r.o. 1351.F0-96174839



**8324**  
mgto desvaporizador Diesel  
r.o. 1192.C6



**8329**  
mgto de calefactor Diesel 2º tramo (de bom-  
ba a empalme 1er. tramo, r.o. 96014742



**8343**  
mgto calefactor 1.1-1.4 gasolina desde '90  
2º tramo, r.o. 6464.L3



**8510**  
mgto de botella a caja termostato 1.5 D  
r.o.



## CITROËN AX

 <p><b>8511</b> mgto de tubo metálico a caja termst. 1.5 D r.o.</p>	 <p><b>8512</b> mgto inferior radiador 1.5 D r.o.</p>	 <p><b>8513</b> mgto de calefactor a tubo metálico 1.5 D r.o.</p>
 <p><b>8514</b> mgto de calefactor a caja termostato 1.5 D r.o.</p>	 <p><b>8533</b> mgto desvaporizador 1.5 D r.o.</p>	 <p><b>2351</b> <span style="float: right;">Ø 41 x 47 mm</span> junta de termostato 1.1 - 1.4 TU r.o.97523016</p>
 <p><b>2352</b> <span style="float: right;">Ø 47 x 53 mm</span> junta de termostato Diesel r.o.96008746</p>	 <p><b>3011</b> boquilla alojamiento termostato 1.1 - 1.4 TU (gasolina), r.o. 1336.44</p>	 <p><b>3081</b> <span style="float: right;">Ø 15,5 mm</span> boquilla en caja termostato 1.1-1.4 gaso- lina, r.o.96064657</p>
 <p><b>3082</b> <span style="float: right;">Ø 10 mm</span> boquilla en caja termostato gasolina todos y Diesel hasta '92, r.o. 96064659</p>	 <p><b>3078</b> boquilla en caja termostato Diesel d/ '92 r.o. 1342.04</p>	 <p><b>3077</b> <span style="float: right;">Ø 20 mm</span> boquilla en caja termostato Diesel d/ '92 r.o. 1338.21</p>
 <p><b>3132</b> tapa de termostato 1.4 D - 1.5 D r.o. 1336.C2</p>	 <p><b>3133</b> tubo metálico de agua 1.5 D r.o. 1204.38</p>	 <p><b>3548</b> tapón radiador o botella de expansión (plástico), r.o. 1306.84 - 1306.C7</p>
 <p><b>3578</b> tapa bomba de agua 1.1 - 1.4 TU r.o. 1201.66</p>	 <p><b>3608</b> tapón de radiador metálico 1.4 bar r.o.</p>	 <p><b>3643</b> botella de expansión 1.4D-1.5D r.o. 1307.V1</p>
 <p><b>3655</b> válvula desvaporizadora 1.5 Diesel con jun- tas tóricas, r.o. 0361.C7 + 0326.21</p>		

**SUSPENSION DELANTERA y SOPORTES DE MOTOR:**

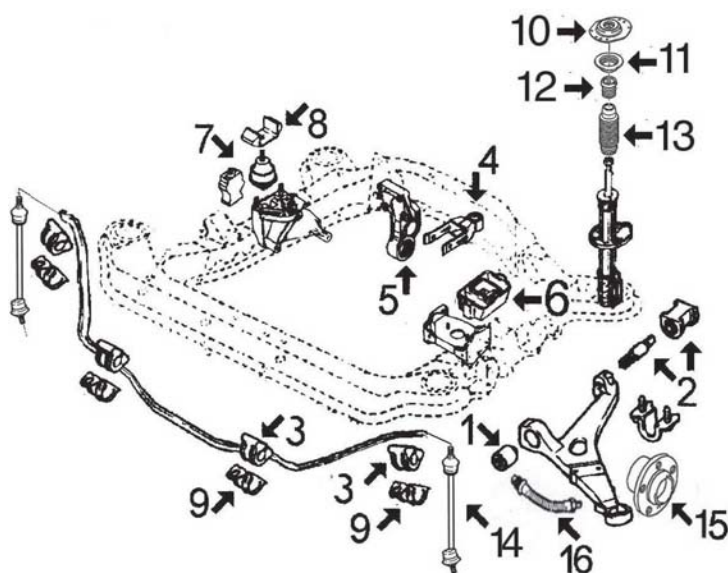





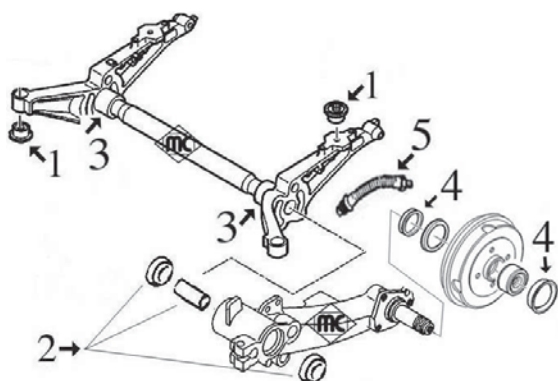









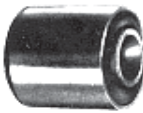

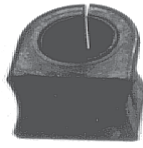

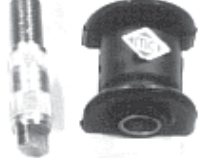
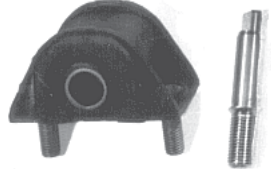
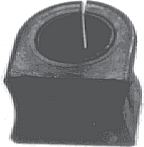
- 1- 2387 silentbloc anterior trapecio delantero salvo GTI
- 2970 silentbloc anterior trapecio delantero GTI
- 2- 977 silentbloc posterior trapecio delantero (juego completo con pasador), hasta '92
- 978 silentbloc posterior trapecio delantero (juego completo con pasador), desde '92
- 3- 903 goma barra estabilizadora Ø 20 mm
- 2385 goma barra estabilizadora Ø 18 mm
- 4- 4746 tirante de motor trasero completo 1.0.1.1-1.4.1.6
- 4744 tirante de motor trasero completo 1.4D-1.5D
- 877 silentbloc del tirante trasero de motor
- 5- 2666 soporte trasero de motor (completo)
- 751 silentbloc del soporte trasero motor salvo 1.5D
- 4064 silentbloc del soporte trasero motor 1.5D
- 6- 897 soporte izquierdo motor 1.1-1.4 gasolina
- n/d soporte izquierdo motor Diesel
- 7- 965 soporte derecho de motor todos hasta '89
- 697 soporte dcho. de motor todos d/'89 (hidráulico)
- 2784 soporte motor dcho. 1.1 desde '92
- 8- 724 limitador soporte derecho de motor desde '89
- 9- 901 abrazadera barra estabilizadora
- 10- 2730 soporte superior amortiguador delantero hasta '94
- 2967 soporte superior amortiguador delantero desde '94
- 11- 4181 rodamiento soporte suspensión
- 12- 2991 tope poliuretano suspensión
- 13- 2974 capuchón amortiguador
- 14- 4332 bieleta puntal barra estabilizadora GTI
- 15- 90044 buje de rueda delantera de 3 agujeros
- 90013 buje de rueda delantera de 4 agujeros
- 16- 96009 latiguillo freno delantero hasta 11/'90
- 96046 latiguillo freno delantero desde 11/'90

**SUSPENSION TRASERA:**



- 1- 2838 silentbloc soporte puente trasero
- 2- 4563 juego de rodamientos, retenes y casquillos brazo trasero
- 3- 4499 eje de brazo trasero (derecho e izquierdo)
- 4- 4828 juego retén eje y tapón tambor
- 5- 96020 latiguillo freno trasero (218 mm)
- 96031 latiguillo freno trasero (235 mm)

## CITROËN AX

 <p><b>697</b>      <b>HIDRAULICO (650g.)</b> soporte motor derecho desde '89 r.o. 1844.38</p>	 <p><b>697/1</b>      <b>no hidráulico (460g.)</b> soporte motor derecho desde '89 r.o. --</p>	 <p><b>724</b> limitador soporte derecho motor desde '89 r.o. 1844.16</p>
 <p><b>751</b>      <b>Ø 65 mm</b> silentbloc soporte de motor trasero salvo 1.5D, r.o. no hay despiece</p>	 <p><b>877</b> silentbloc tirante de motor trasero r.o. 1809.04(12x30x28x34)</p>	 <p><b>897</b> soporte motor izquierdo 1.1-1.4 gasolina r.o. 96038337</p>
 <p><b>901</b> abrazadera de barra estabilizadora 1.4 r.o. 95632726</p>	 <p><b>903</b> goma para barra estabilizadora de Ø 21 mm r.o. 95638920</p>	 <p><b>965</b> soporte motor derecho todos hasta '89 r.o. 95205626</p>
 <p><b>977 completo</b>      <b>977/1 sin eje</b> silentbloc posterior trapecio delantero completo hasta '92, r.o. 96133255+96058684</p>	 <p><b>978 completo</b>      <b>978/1 sin eje</b> silentbloc posterior trapecio delt. completo desde '92, r.o. 96106474+95634285</p>	 <p><b>2385</b> goma para barra estabilizadora de Ø 19 mm r.o. 95638919</p>
 <p><b>2387</b> silentbloc anterior trapecio delantero salvo GTI, r.o. 95603308</p>	 <p><b>2666</b> soporte motor trasero completo r.o. 1844.54</p>	 <p><b>2730</b> soporte superior amortiguador delantero hasta '94, r.o. 5038.08</p>
 <p><b>2784</b> soporte motor derecho 1.1 desde '92 r.o. 1843.99</p>	 <p><b>2838</b> silentbloc soporte tren trasero r.o. 5131.65</p>	 <p><b>2967</b> soporte amortiguador delantero desde '94 r.o. 5038.15</p>
 <p><b>2970</b> silentbloc anterior trapecio delantero GTI r.o. 3523.52</p>	 <p><b>2974</b> capuchón amortiguador delantero r.o. 5254.18</p>	 <p><b>2991</b> tope suspensión delantera (poliuretano) r.o. 5033.35</p>

## CITROËN AX



**4064**  
silentbloc soporte motor trasero 1.5 D  
r.o. no hay despiece



**4181**  
rodamiento soporte suspensión  
r.o. 5035.23



**4332**  
bioleta puntal barra estabilizadora GTI  
r.o. 5087.33

**¡Nuevo!**



**4499**  
eje brazo trasero (derecho e izquierdo)  
r.o. no existe despiece en origen

**¡Nuevo!**



**4563**  
juego rodamientos, retenes y casquillos en  
eje brazo trasero, r.o.

**¡Nuevo!**



**4744**  
tirante de motor trasero 1.4D - 1.5D  
r.o.

**¡Nuevo!**



**4746**  
tirante de motor trasero 0.9-1.1-1.4-1.6  
r.o.

**¡Nuevo!**



**4828**  
juego retén eje trasero y tapón tambor  
r.o. 3724.24+3740.19



**90013**  
buje de rueda delantera de 4 agujeros  
r.o. 3307.49



**90044**  
buje de rueda delantera de 3 agujeros  
r.o. 3307.74



**96009**  
latiguillo freno delantero hasta 11/90  
(352 mm), r.o. 75492063

**¡Nuevo!**



**96046**  
latiguillo freno delantero desde 11/90  
(325 mm), r.o. 96102107



**96020**  
latiguillo freno trasero hasta 3/94  
(218 mm), r.o. 95599101



**96031**  
latiguillo freno trasero desde 3/94 ó +ABS  
(265 mm), r.o. 96124223



## C- ARTICULACIONES PALANCA DE CAMBIO:

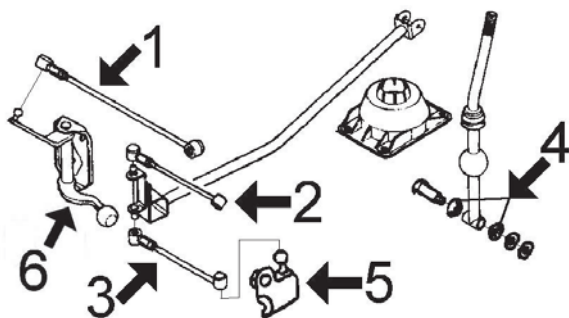

- 1- 2377 bieleta selección cambio velocidades
- 2- 2376 bieleta selección cambio velocidades
- 3- 2375 bieleta selección cambio velocidades
- 4- 2400 casquillo palanca de cambio
- 5- 2396 soporte bieleta inferior
- 6- 4988 articulación reenvio

long. máx. 190 mm  
long. mín. 175 mm  
rótulas de Ø 10 mm



**2375**  
bieleta inferior mando cambio  
r.o. 95636573

long. máx. 190 mm  
long. mín. 175 mm  
rótulas de Ø 10 mm



**2376**  
bieleta central mando cambio  
r.o. 95631090

rótulas de Ø 13 mm



**2377**  
bieleta superior mando cambio  
r.o. 2452.69



**2396**  
soporte bieleta inferior  
r.o. 2163.08



**2400**  
casquillo palanca cambio  
r.o. 95634960

**¡Nuevo!**



**4988**  
articulación reenvio palanca cambio  
r.o. 2449.65

**¡Nuevo!**



**3697**  
juego tapas correa distribución 1.1-1.4  
(motores TU1-TU3), r.o. 0320.S2+0320.L3

**¡Nuevo!**



**3696**  
juego tapas correa distribución 1.5D  
(motor TUD5), r.o. 0320.K6+0320.P5

**2335**  
varilla nivel aceite 0.9-1.1-1.4-1.6-1.4D  
r.o. 1174.10-1174.49

**¡Nuevo!**



**4595**  
varilla nivel aceite 1.5 Diesel  
r.o. 1174.23

**¡Nuevo!**



**3639**  
tapón llenado aceite TU-0.9-1.1-1.3-1.6  
r.o. 0258.55

**¡Nuevo!**



**4424**  
casquillo guía embrague con retén  
r.o. 2105.14

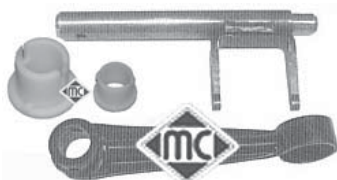

**4300**  
horquilla embrague completa con casquillos  
r.o. 2117.52



**4057**  
juego casquillos horquilla embrague  
r.o. 2175.11+2175.12

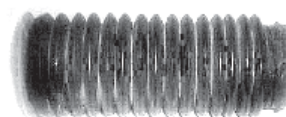

**1609**  
fuelle cremallera dirección  
r.o. 9451076880-9451083480

## CITROËN AX

 <p><b>904</b> capuchón izquierdo cremallera dirección r.o. 9451076780</p>	 <p><b>2401</b> casquillo cremallera dirección r.o. 95633847</p>	 <p><b>1532-E</b> kit rep transm l/rda <b>para montar en cono</b> en neopreno especial de elasticidad 800%</p>
 <p><b>1533</b> kit rep. transmisión lado cambio todos (cárter de 87 mm, Ø 78), r.o. 3287.69</p>	 <p><b>1532</b> kit rep. transm. l/rda. todos salvo GTI d/90 r.o. 3293.81</p>	 <p><b>1710-E</b> kit rep transm. l/rda. para montar en cono en neopreno especial de elasticidad 800%</p>
 <p><b>1710</b> kit rep. transmisión l/rda GTI desde '90 r.o. 3293.77</p>	 <p><b>1521</b> kit rep transmisión l/rda desde '94 r.o.</p>	 <p><b>4564</b>      Ø 30/47 y 40/58 mm juego retenes diferencial-transmisiones r.o. 3121.44+3124.46</p>
 <p><b>2964</b>      junta de Ø 63 x 48 mm kit montaje colector escape (vehículos e- quipados con catalizador), r.o.</p>	 <p><b>2392</b>      junta de Ø 60 x 46 mm kit montaje tubo escape 1.1-1.4 y 1.4D r.o.</p>	 <p><b>2393</b>      Ø 46.2 mm junta cónica tubo escape r.o. 95602682</p>
 <p><b>2417</b> soporte silenciador trasero r.o. 95640799</p>	 <p><b>749</b>      Ø 69 mm collarín tubo de escape GT-Sport r.o. 95483762</p>	 <p><b>643</b>      Ø 53 mm collarín tubo de escape 1.4 salvo GT-Sport r.o.</p>
 <p><b>2025</b> arandela tapón cárter con retén de goma r.o. 97532428</p>	 <p><b>667</b> tapón cárter de aceite 16x150 r.o. 7830197000</p>	 <p><b>4036</b> bomba cebado Diesel con válvula antirre- torno y boquilla adicional a 90°, r.o. 1579.73</p>
 <p><b>942</b> funda protectora Delco r.o. 5966.16</p>	 <p><b>2773</b> cubrepedal freno y embrague r.o. 95575913-2130.14</p>	

# CITROËN BERLINGO

## CANALIZACIONES DE AGUA:

### mgtos. BERLINGO gasolina motores 1.1 - 1.4 y 1.6 TU (hasta '02):

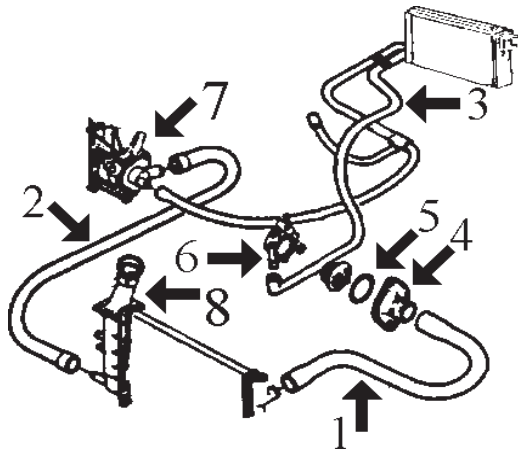

- 1- 8266 mgtto superior radiador 1.1  
8298 mgtto superior radiador 1.4-1.6 hasta PR-8025 ('98)  
8607 mgtto superior radiador 1.4-1.6 desde PR-8026 ('98)
- 2- 8265 mgtto inferior radiador hasta PR-8025 ('98)  
2113 junta tórica para mgtto inferior ref. 8265  
8476 mgtto inferior radiador desde PR-8026 ('98)  
2113 junta tórica conector rápido mgtto inferior
- 3- 8300 mgtto doble de calefacción hasta '98  
8535 mgtto doble de calefacción desde '98
- 4- 3011 tapa de termostato hasta '98 (metálica)  
3611 tapa con termostato desde '98 (plástico)
- 5- 2351 junta de termostato hasta '98
- 6- 3081 boquilla metálica inferior en caja termostato  
3082 boquilla metálica superior en caja termostato
- 7- 3578 tapa bomba de agua 1.1-1.4  
3640 tapa bomba de agua 1.6
- 8- 3548 tapón de radiador (1.4 bar)

### mgtos. BERLINGO gasolina motor 1.8 (XU7JB)

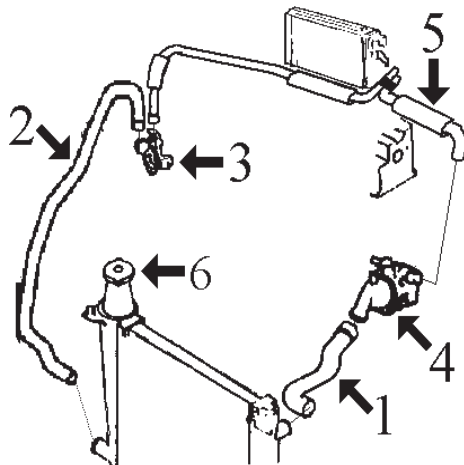

- 1- 8295 mgtto superior radiador
  - 2- 8294 mgtto inferior radiador hasta PR-8025 ('98)  
2113 junta tórica para mgtto inferior ref. 8294  
8477 mgtto inferior radiador desde PR-8026 ('98)  
2113 junta tórica conector rápido mgtto inferior
  - 3- 3523 brida agua conexión manguitos agua
  - 4- 3538 tapa de termostato  
2351 junta de termostato  
3077 boquilla metálica en caja termostato Ø 19 mm  
3078 boquilla metálica en caja termostato Ø 10 mm
  - 5- 8301 mgtto doble de calefacción
  - 6- 3548 tapón de radiador (1.4 bar)
- 8854 mgtto desvaporizador

### mgtos. BERLINGO 1.7 y 1.9 Diesel, motores XUD7 y XUD9 (hasta '99)

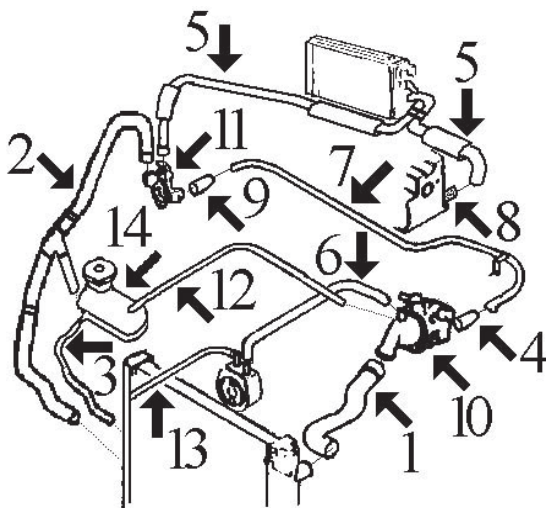

- 1- 8268 mgtto superior radiador hasta '97 (3 vias)  
8437 mgtto superior radiador desde '97
- 2- 8436 mgtto inferior radiador hasta PR-8025 ('98)  
2113 junta tórica para mgtto inferior ref. 8436  
8479 mgtto inferior radiador desde PR-8026 ('98)  
2113 junta tórica conector rápido mgtto inferior
- 3- 116 mgtto de botella a radiador, cortar de rollo MC-116, Ø 8x14 longitud 250 mm.
- 4- 8183 mgtto de tubo metálico a caja termostato hasta '98  
8480 mgtto de tubo metálico a caja termostato desde '98
- 5- 8303 mgtto doble de calefactor hasta PR-8576 ('98)  
8482 mgtto doble de calefactor desde PR-8576 ('98)
- 6- 8313 mgtto de intercambiador a caja termostato
- 7- 3057 tubo metálico
- 8- 3059 boquilla en culata
- 9- 8312 mgtto de tubo metálico a brida conexión mgttos.
- 10- 3539 tapa de termostato  
2361 junta de termostato Ø 51x58 mm
- 11- 3503 brida agua conexión manguitos
- 12- 116 mgtto de botella a caja de termostato. Cortar de rollo MC-116, Ø 8x14 longitud 750 mm
- 13- 8438 mgtto de intercambiador a radiador d/ '97 (sólo cuando el mgtto sup. radiador NO es de 3 vias)
- 14- 3545 botella de expansión  
3548 tapón botella de expansión 1.4 bar



## mgtos. BERLINGO 1.9 Diesel motor DW8 (desde '99 hasta '02):

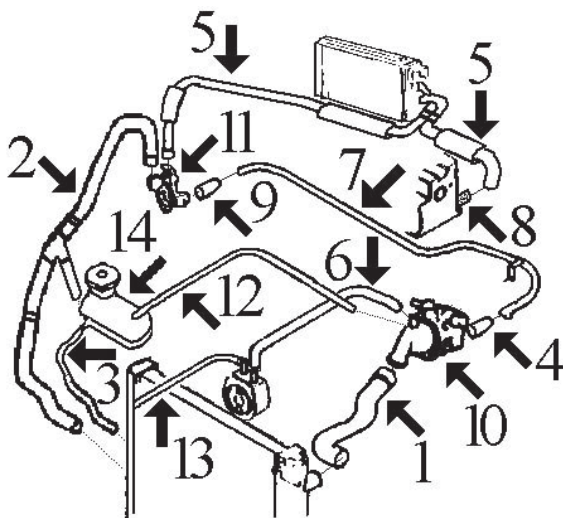

- 1- 8437 mgtto superior radiador
- 2- 8479 mgtto inferior radiador
- 3- 116 mgtto de botella a radiador, cortar de rollo MC-116, Ø 8x14 longitud 250 mm.
- 4- 8480 mgtto de tubo metálico a caja termostato
- 5- 8482 mgtto doble de calefactor
- 6- 8478 mgtto de intercambiador a caja termostato
- 7- 3129 tubo metálico
- 8- 3059 boquilla en culata
- 9- 8312 mgtto de tubo metálico a brida conexión mgtos.
- 10- 3539 tapa de termostato
- 2361 junta de termostato Ø 51x58 mm
- 11- 3544 brida agua conexión manguitos
- 12- 116 mgtto de botella a caja de termostato. Cortar de rollo MC-116, Ø 8x14 longitud 930 mm
- 13- 8481 mgtto de intercambiador a radiador
- 14- 3545 botella de expansión
- 3548 tapón botella de expansión 1.4 bar

## mgtos. BERLINGO 2.0 Diesel HDI, motor DW10 (hasta '02):

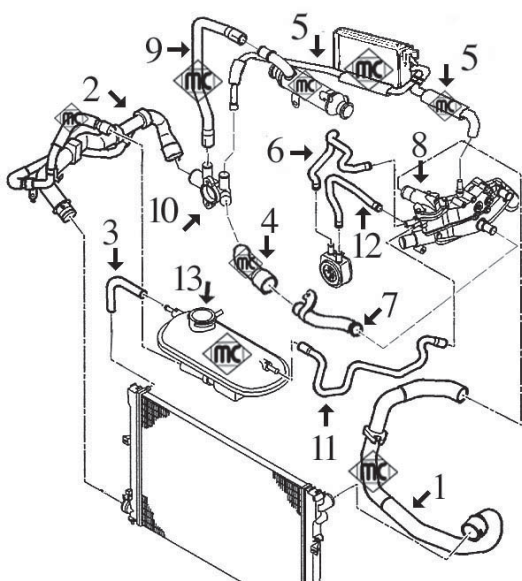

- 1- 8553 mgtto superior radiador
- 2- 8479 mgtto inferior radiador
- 3- 116 mgtto de botella a radiador, cortar de rollo MC-116, Ø 8x14 longitud 250 mm.
- 4- 8575 mgtto de tubo metálico a racor entrada
- 5- 8555 mgtto doble de calefactor
- 6- 8554 mgtto de intercambiador a caja termostato
- 7- 3139 tubo metálico con junta tórica
- 8- 3135 tapa de termostato (aluminio)
- 3556 tapa de termostato (plástico)
- 9- 8668 mgtto de racor a filtro de partículas
- 10- 3544 racor plástico conexión manguitos
- 11- 8658 mgtto de botella a caja termostato
- 12- 8586 mgtto de intercambiador a caja termostato
- 13- 3545 botella de expansión
- 3548 tapón botella de expansión 1.4 bar



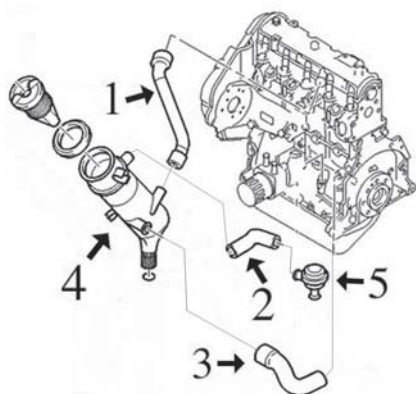























## mgtos. DESVAPORIZADORES 1.7D - 1.9D/TD y 2.0 Diesel HDi

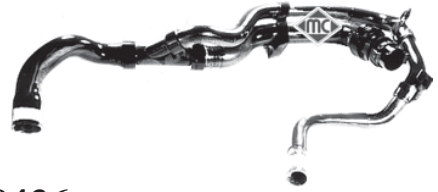

- 1- 8307 mgtto de tapa balancines a decantador motores XUD
- 8475 mgtto de tapa balancines a colector motor 1.9 DW8
- 8539 mgtto de tapa balancines a colector motor 2.0 HDi
- 2- 8473 mgtto de decantador a válvula motor 1.7 XUD
- 8167 mgtto de decantador a válvula motor 1.9 XUD
- 3- 8166 mgtto de bloque a decantador motores 1.7-1.9 XUD
- 8474 mgtto de bloque a culata motor 1.9 DW8
- 8540 mgtto de bloque a culata motor 2.0 HDi
- 4- 3631 decantador completo con tapón 1.7D-1.9D-1.9TD
- 5- 3637 válvula desvaporizadora 1.7D-1.9D (motores XUD)



## CITROËN BERLINGO

  <p><b>8166</b> mgto desvaporizador Diesel r.o. 1192.48</p>	  <p><b>8167</b> mgto desvaporizador Diesel r.o. 1180.A3</p>	 <p><b>8183</b> mgto de termostato a tubo metálico Diesel r.o. 1307.W3</p>
 <p><b>8265</b> mgto inferior radiador 1.1 y 1.4 r.o. 1351.J4</p>	 <p><b>8266</b> mgto superior radiador 1.1 r.o. 1343.V6</p>	 <p><b>8268</b> mgto superior radiador Diesel hasta '97 r.o. 1343.V5</p>
 <p><b>8294</b> mgto inferior radiador 1.8 gasolina r.o. 1351.V5</p>	 <p><b>8295</b> mgto superior radiador 1.8 gasolina r.o. 1343.X4</p>	 <p><b>8298</b> mgto superior radiador 1.4 r.o. 1343.J3</p>
 <p><b>8300</b> mgto doble de calefactor 1.1 - 1.4 r.o. 6464.PW</p>	 <p><b>8301</b> mgto doble de calefactor 1.8 gasolina r.o. 6464.PZ</p>	 <p><b>8303</b> mgto doble de calefactor Diesel r.o. 6464.NV</p>
  <p><b>8307</b> mgto desvaporizador Diesel r.o. 1180.86</p>	 <p><b>8312</b> mgto de tubo metálico a brida de conexión Diesel, r.o. 1307.W4</p>	 <p><b>8313</b> mgto de intercambiador a termost. Diesel r.o. 1307.AA</p>
 <p><b>8436</b> mgto inferior radiador Diesel r.o. 1351.V8</p>	 <p><b>8437</b> mgto superior radiador Diesel desde '97 r.o. 1343.X2</p>	 <p><b>8438</b> mgto de intercambiador a radiador d/'97 r.o. 1307.JP</p>
  <p><b>8473</b> mgto desvaporizador 1.7-1.9 XUD r.o. 1180.A1</p>	  <p><b>8474</b> mgto desvaporizador 1.9 D (DW8) desde '99 r.o. 1180.G4</p>	  <p><b>8475</b> mgto desvaporizador 1.9D (DW8) desde '99 r.o. 1180.G5</p>

## CITROËN BERLINGO



**8476**  
mgto inf radiador 1.1-1.4 TU desde '98  
r.o.



**8477**  
mgto inf radiador 1.8 gasolina desde '98  
r.o.



**8478**  
mgto de intercambiador a tapa 1.9D '99  
r.o.



**8479**  
mgto inf radiador 1.9 D desde '99  
r.o.



**8480**  
mgto de caja termost. a tubo 1.9D '99  
r.o.



**8481**  
mgto de intercambiador a radiador 1.9D '99  
r.o.



**8482**  
mgto calefactor 1.9 D desde '99 (DW8)  
r.o.



**8535**  
mgto doble calefactor 1.1-1.4 desde '98  
r.o.



**8539**  
mgto desvaporizador 2.0 HDi  
r.o.



**8540**  
mgto desvaporizador 2.0 HDi  
r.o.



**8553**  
mgto superior radiador 2.0 HDi  
r.o.



**8554**  
mgto de intercambiador a caja 2.0 HDi  
r.o.



**8555**  
mgto doble calefactor 2.0 HDi  
r.o.



**8575**  
mgto de caja termostato a tubo 2.0 HDi  
r.o.



**8586**  
mgto intercamb. filtro de aceite 2.0 HDi  
r.o.



**8607**  
mgto superior radiador 1.4 desde '98  
r.o.



**8658**  
mgto de botella a caja termostato 2.0 HDi  
r.o.



**8668**  
mgto de racor a filtro de partículas 2.0 HDi  
r.o. 1307.RS



**8854**  
mgto desvaporizador 1.8 XU  
r.o. 1180.62

**¡Nuevo!**

## CITROËN BERLINGO

 <p><b>3011</b> tapa de termostato 1.1 - 1.4 hasta '98 r.o. 97523152</p>	 <p><b>3057</b> tubo metálico 1.9 Diesel hasta '98 r.o. 1307.W2</p>	 <p><b>3059</b> boquilla en culata Diesel salvo HDi r.o. 0245.42 - 0245.44</p>
 <p><b>3077</b> boquilla en caja termostato 1.8 r.o. 1341.63</p>	 <p><b>3078</b> boquilla en caja termostato 1.8 r.o. 1336.K8</p>	 <p><b>3081</b>                      <b>Ø 15,5 mm</b> boquilla en caja termostato 1.1 - 1.4 r.o. 96064657</p>
 <p><b>3082</b>                      <b>Ø 10 mm</b> boquilla en caja termostato 1.1 - 1.4 r.o. 96064659</p>	 <p><b>3129</b> tubo de agua 1.9 Diesel desde '99 (DW8) r.o.</p>	 <p><b>3135</b> tapa de termostato 2.0 HDi (aluminio) r.o. 1336.P2</p>
 <p><b>3139</b> tubo de agua 2.0 HDi con junta tórica r.o. 1307.YZ</p>	 <p><b>3171</b> boquilla en caja termostato 1.8-1.9D r.o. 1336.N7</p>	
 <p><b>3503</b>                      <b>con junta tórica</b> brida conexión manguitos Diesel hasta '98 r.o. 1336.G4</p>	 <p><b>3523</b>                      <b>con junta tórica</b> brida conexión manguitos 1.8 r.o. 1336.H7 - 1336.J7</p>	 <p><b>3538</b> tapa de termostato 1.8 gasolina r.o. 1336.A1</p>
 <p><b>3539</b> tapa de termostato 1.7 - 1.9 Diesel r.o. 1336.C9</p>	 <p><b>3544</b> brida conex. mgts 1.9 D desde '99 y 2.0 HDi r.o. 1336.P0 - 1336.Q3</p>	 <p><b>3545</b> botella de expansión 1.7D-1.9D y 2.0HDi r.o. 1307.HN</p>
 <p><b>3548</b> tapón radiador / botella expansión 1.4 bar r.o. 1306.C7 - 1306.84</p>	 <p><b>3556</b> tapa de termostato 2.0 HDi (plástico) r.o. 1336.R9</p>	 <p><b>3578</b> tapa bomba de agua motores TU r.o. 1201.66</p>

## CITROËN BERLINGO



**3611**  
tapa con termostato 1.1 - 1.4 desde '98  
r.o. 1336.Q2



**3631**  
decantador completo con tapón motor 1.7D-  
1.9XUD y 1.9XUDTE, r.o.

*Nuevo!*



**3637**  
válvula desvaporizadora 1.9D XUD  
r.o. 0361.58

*Nuevo!*



**3640**  
tapa bomba de agua 1.6 TU (TU5J)  
r.o. 1201.C3

*Nuevo!*



**3641**  
tapa bomba de agua 1.1-1.4 desde '02-  
r.o. 1201.C2

*Nuevo!*



**3658**  
botella de expansión desde '02- con tapón  
sensor, r.o. 1323.23



**2361**                      Ø 51 x 58 mm  
junta de termostato Diesel  
r.o. 1339.92



**2351**                      Ø 41 x 47 mm  
junta de termostato 1.8  
r.o. 1339.53

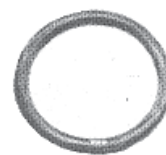

**2113**                      Ø 33,5 x 3,15 mm  
junta tórica conector mgto inferior radiad.  
(hasta '98) r.o. 1307.V8



## SUSPENSION DELANTERA y SOPORTES DE MOTOR

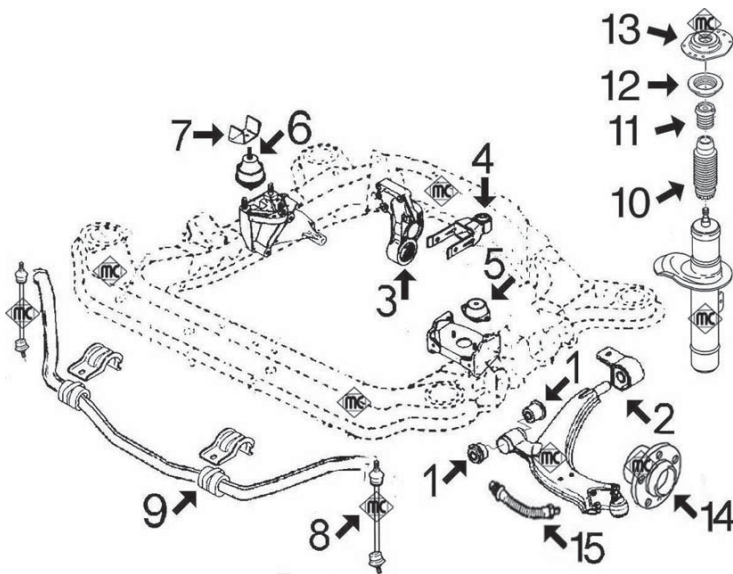

- 1- 962 silentbloc anterior trapecio delantero
- 2- 979 silentbloc posterior trapecio delantero hasta '02  
4063 silentbloc posterior trapecio delantero desde '02
- 3- 751 silentbloc soporte post. motor 1.1 - 1.4 hasta '98  
4064 silentbloc soporte post. motor 1.1 - 1.4 desde '98  
2869 silentbloc soporte posterior motor 1.8 gasolina y 1.9 Diesel hasta '98  
2980 silentbloc soporte posterior motor 1.9 D desde '98 y 2.0 HDi
- 4- 4743 tirante posterior de motor completo 1.1-1.4.1.6  
4745 tirante posterior de motor completo 1.8XU, 1.9XUD, 1.9DW8 hasta '02 y 2.0HDi hasta '02  
4746 tirante posterior de motor completo 1.9DW8 desde '02 y 2.0HDi desde '02  
877 silentbloc tirante posterior de motor 1.1 - 1.4  
2871 silentbloc tirante posterior de motor 1.8 y Diesel
- 5- 2786 soporte izquierdo de motor 1.1 - 1.4  
2794 soporte izquierdo de motor 1.8 y Diesel
- 6- 697 soporte derecho motor 1.1 - 1.4 y 1.8  
2309 soporte derecho motor Diesel
- 7- 2884 limitador superior soporte derecho motor
- 8- 2937 bieleta puntal barra estabilizadora
- 9- 2412 goma barra estabilizadora para barra de Ø 21 mm  
2932 goma barra estabilizadora para barra de Ø 22 mm
- 10- 2933 capuchón amortiguador
- 11- 2971 tope poliuretano hasta '97  
2934 tope poliuretano desde '98
- 12- 4181 rodamiento
- 13- 2935 soporte amortiguador dcho. e izqdo. (reversible)
- 14- 90012 buje de rueda delantera
- 15- 96015 latiguillo freno delantero

## SUSPENSION TRASERA

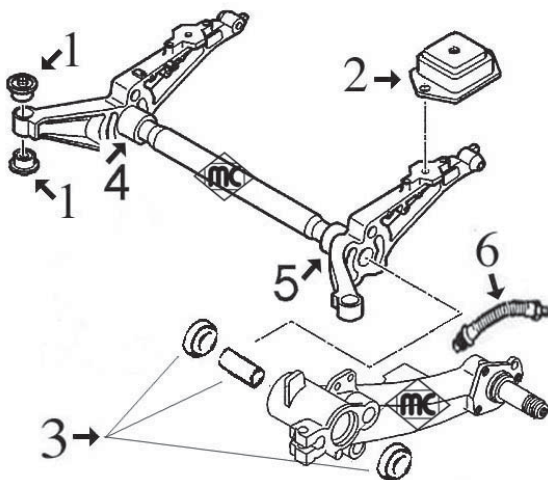

- 1- 4247 silentblocs puente trasero
- 2- 2936 soporte posterior puente
- 3- 4414 juego reparación brazo trasero completo con rodamientos, retenes y casquillos
- 4- 4552 eje brazo trasero derecho
- 5- 4551 eje brazo trasero izquierdo
- 6- 96016 latiguillo freno trasero (255 mm)

## CITROËN BERLINGO



**697** **HIDRAULICO (650 g.)**  
soporte de motor derecho 1.1 - 1.4 y 1.8  
r.o. 1844.38

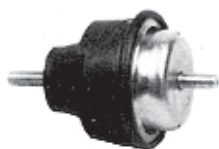

**697/1** **no hidráulico (460 g.)**  
soporte de motor derecho 1.1 - 1.4 y 1.8  
r.o. ----



**751** **Ø 65 mm**  
silentbloc soporte de motor trasero 1.1 - 1.4  
hasta '98. r.o. no hay despiece

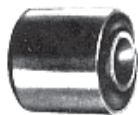

**877**  
silentbloc tirante post. motor 1.1 - 1.4  
r.o. 1809.04 (12x30x28x34)



**962**  
silentbloc anterior trapecio delantero  
r.o. no hay despiece



**979**  
silentbloc posterior trapecio delantero has-  
ta '02, r.o. no hay despiece



**2309** **HIDRAULICO (950 g.)**  
soporte de motor derecho Diesel  
r.o. 1844.47



**2309/1** **no hidráulico (610 g.)**  
soporte de motor derecho Diesel  
r.o. ----



**2412** **con ánima metálica**  
goma para barra estabilizadora de 21 mm  
r.o. 5094.65



**2786**  
soporte de motor izquierdo 1.1 - 1.4  
r.o. 1844.51

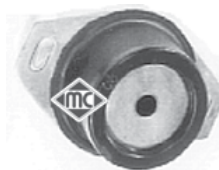

**2794**  
soporte de motor izquierdo 1.8 y Diesel  
r.o. 1844.36

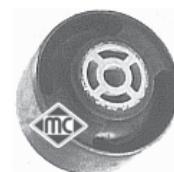

**2869** **Ø 70 mm**  
silentbloc soporte de motor trasero 1.8 y D  
hasta '98. r.o. 1809.16



**2871**  
silentbloc tirante posterior motor 1.1 - 1.4  
r.o. 1809.22



**2884**  
limitador soporte de motor derecho  
r.o. 1844.25



**2932** **con ánima metálica**  
goma para barra estabilizadora de 22 mm  
r.o. 5094.77



**2933**  
capuchón amortiguador delantero  
r.o. 5254.13



**2934**  
tope suspensión delantera, altura **109 mm**  
r.o. 5033.40



**2935** **reversible**  
soporte amortiguador delantero dcho. e  
izqdo., r.o. 5038.24-5038.23-5038.21



**2936**  
soporte posterior puente trasero  
r.o. 5152.62



**2937**  
bieleta puntal barra estabilizadora delantera  
r.o. 5087.46



**2971**  
tope suspensión delantera, altura **98 mm**  
r.o. 5033.27 - 5033.51

## CITROËN BERLINGO

 <p><b>2980</b> silentbloc soporte de motor trasero 1.8 y D desde '98, r.o. 1809.21</p>	 <p><b>4063</b> silentbloc trapecio delantero desde '02- r.o. 3523.83</p>	 <p><b>4064</b> <span style="float: right;">Ø 65 mm</span> silentbloc soporte de motor trasero 1.1-1.4 desde '98, r.o. no hay despiece</p>
 <p><b>4181</b> rodamiento en soporte amortiguador r.o. 5035.27</p>	 <p><b>4247</b> silentbloc puente trasero r.o. 5131.47</p>	 <p><b>4414</b> jgo. reparación brazo trasero completo con rodamientos, r.o. 5131.48+5131.49</p>
 <p><b>4743</b> <span style="float: right;">Ø 12 mm</span> tirante trasero motor completo 1.1-1.4-1.6 r.o.</p>	 <p><b>4745</b> <span style="float: right;">Ø 10 mm</span> tirante trasero motor completo 1.8-1.9-2.0 r.o.</p>	 <p><b>4746</b> <span style="float: right;">Ø 12 mm</span> tirante trasero motor completo 1.9D y 2.0 HDi desde '02-, r.o.</p>
 <p><b>4551</b> eje brazo trasero izquierdo r.o.</p>	 <p><b>4552</b> eje brazo trasero derecho r.o.</p>	 <p><b>90012</b> buje de rueda delantera r.o. 3307.72</p>
 <p><b>96015</b> latiguillo freno delantero (483 mm) r.o. 4806.85</p>	 <p><b>96016</b> latiguillo freno trasero (255 mm) r.o. 4806.86</p>	

## ARTICULACIONES PALANCA DE CAMBIO

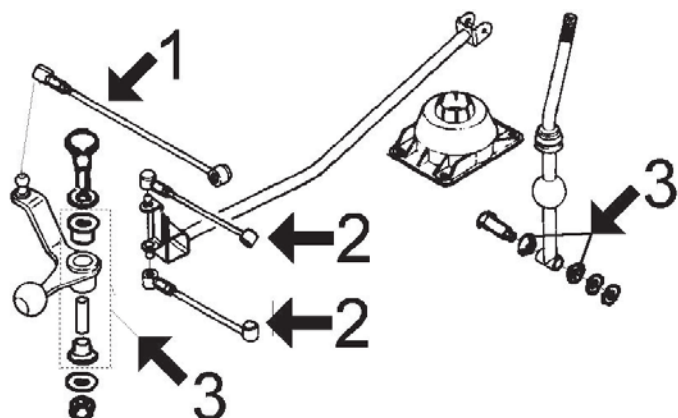

- 1- 2866 bieleta selección velocidades 1.1-1.4TU (cambio MA) y 1.8-1.9D-2.0HDi hasta '01 (cambio BE3R)
- 4420 bieleta selección velocidades 1.8-1.9DW-2.0HDi desde '01 (cambio BE4R)
- 2- 2865 bieleta selección velocidades MA-BE3R y BE4R
- 3- 4990 articulación reenvío completa con casquillos 1.1-1.4TU (cambio MA)
- 4992 articulación reenvío completa con casquillos hasta -'01, 1.8-1.9D-2.0HDi (cambio BE3R)
- 4991 articulación reenvío completa con casquillos desde '01-, 1.8-1.9D-2.0HDi (cambio BE4R)
- 2400 casquillo base palanca cambio

rótulas de Ø 13 mm  
longitud máxima 300 mm  
longitud mínima 240 mm



**2866**  
bieleta selección cambio  
r.o. 2454.E6-2454.E9

rótulas de Ø 10 mm  
longitud máxima 140 mm  
longitud mínima 80 mm



**2865**  
bieleta selección cambio  
r.o. 2452.75-2452.79

**¡Nuevo!**

rótulas de Ø 10 y Ø 13 mm  
longitud máxima 280 mm  
longitud mínima 230 mm



**4420**  
bieleta selección cambio BE4R  
r.o. 2452.81

**¡Nuevo!**



**4990**  
articulación reenvío cambio completa con casquillos, 1.1-1.4TU (cambio MA)

**¡Nuevo!**



**4992**  
articulación reenvío cambio completa con casquillos 1.8-1.9D-2.0HDi hasta -'01

**¡Nuevo!**



**4991**  
articulación reenvío cambio completa con casquillos 1.8-1.9D-2.0HDi desde -'01



**2400**  
casquillo base palanca cambio  
r.o.

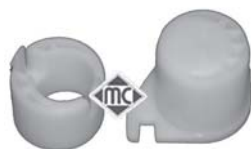

**4043**  
juego casquillos horquilla embrague motores XU y DW hasta '01, r.o. 2175.20-2175.21

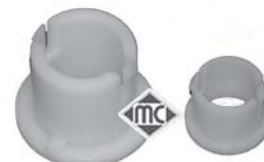

**4057**  
juego casq. horquilla embrague motor TU  
r.o. 2175.11-2175.12

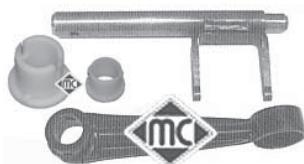

**4300**  
horquilla embrague completa con casquillos motores TU, r.o. 2117.52



**4052**  
horquilla embrag. completa con casquillos motores XU y DW hasta '01, r.o. 2115.25























**4066**  
horquilla embrague 1.9DW8 y 1.6TU5 desde '01, r.o. 2117.58

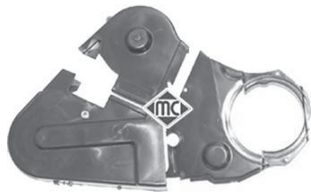

## CITROËN BERLINGO

<p><b>4424</b> casquillo guía embrague 1.1-1.4 TU con retén r.o. 2105.14</p> <p>altura 55,50 mm</p>	<p><b>4796</b> casquillo guía embrague 1.1-1.4 TU con retén, r.o. 2105.38</p> <p>altura 56,50 mm</p>	<p><b>4605</b> casquillo guía embrague 1.8-1.9D-2.0HDi r.o. 2105.35</p>
<p><b>3639</b> tapón llenado aceite 1.1-1.4 TU r.o. 0258.55</p>	<p><b>3659</b> tapón llenado aceite 1.6 TU r.o. 0258.56-258.65</p>	<p><b>3642</b> tapón llenado aceite 1.9DW8-2.0HDi r.o. 1180.F9</p>
<p><b>2335</b> varilla nivel aceite 1.1-1.4 TU hasta '02 r.o. 1174.10-1174.49</p>	<p><b>4593</b> varilla nivel aceite 1.1-1.4 TU desde '02 r.o.</p>	<p><b>4612</b> varilla nivel aceite 1.9 Diesel XUD r.o. 1174.15</p>
<p><b>4596</b> varilla nivel aceite 1.9DW8 r.o.</p>	<p><b>4594</b> varilla nivel aceite 2.0HDi r.o.</p>	<p><b>4479</b> juego silentblocs soporte tapa motor HDi r.o. 0137.68+0137.11</p>
<p><b>1648</b> fuelle derecho cremallera manual r.o. 4066.44</p>	<p><b>1740</b> fuelle izquierdo cremallera manual r.o. 4066.43</p>	<p><b>287</b> juego casquillos cremallera manual r.o.</p>
<p><b>2911</b> silentbloc pistón cremallera asistida r.o. 4059.10 (12x24x20x24)</p>	<p><b>2410</b> silentbloc pistón cremallera asistida r.o. 4059.07 (12x22x20x24)</p>	<p><b>4564</b> juego retenes diferencial-transmisión r.o. 3121.44+3121.46</p> <p>Ø 30/47 y 40/58 mm</p>
<p><b>1536</b> fuelle derecho cremallera asistida r.o. 4066.22</p>	<p><b>1268</b> fuelle izquierdo cremallera asistida r.o. 4066.20</p>	<p><b>844</b> capuchón derecho cremallera asistida r.o. 4066.16</p>

## CITROËN BERLINGO

 <p><b>1222</b> kit fuelle transmisión l/rueda 1.8-1.9D-2.0HDi r.o. 3293.03</p>	 <p><b>1213</b> kit fuelle transm. l/cambio 1.8-1.9D-2.0HDi r.o. 3287.81</p>	 <p><b>1521</b> kit rep. transmisión l/rda 1.1 - 1.4 hasta '98 (salvo ABS) r.o.</p>
 <p><b>1432</b> kit rep. transmisión l/rueda 1.1-1.4 hasta '98 (con ABS) r.o.</p>	 <p><b>1533</b> kit rep. transmisión l/cbo 1.1-1.4 hasta '98 r.o. 3287.69</p>	 <p><b>1428</b> kit rep. transmisión l/cbo 1.1 - 1.4 desde '98 r.o.</p>
 <p><b>1427</b> kit rep. transmisión l/rueda 1.1-1.4 desde '98 r.o.</p>	<p><i>¡Nuevo!</i></p>  <p><b>4440</b>      Ø 148 mm 6 canales polea cigueñal 1.1-1.4-1.6 TU hasta 10/04 r.o. 0515.P5-0515.R8</p>	<p><i>¡Nuevo!</i></p>  <p><b>4442</b>      Ø 148 mm 6 canales polea cigueñal 1.1-1.4-1.6 TU desde 10/04 r.o. 0515.S1-0515.P1</p>
 <p><b>2926</b> polea cigueñal 1.7-1.9 Diesel XU (hasta '99) r.o. 0515.G3</p>	 <p><b>2927</b> polea cigueñal 1.9 Diesel DW8 (desde '99 hasta 10/04), r.o. 0515.Q6</p>	<p><i>¡Nuevo!</i></p>  <p><b>4610</b> polea cigueñal 1.9 Diesel DW8 (desde '02-) r.o. 0515.R5</p>
 <p><b>2928</b> polea cigueñal 2.0 HDi hasta 10/04 r.o. 0515.P2</p>	<p><i>¡Nuevo!</i></p>  <p><b>4477</b> polea cigueñal 2.0 HDi desde 10/04 r.o. 0515.S4</p>	 <p><b>2931</b> tensor correa alternador 1.9 D completo r.o. 5751.81</p>
<p><i>¡Nuevo!</i></p>  <p><b>3697</b> juego tapas correa distribución 1.1-1.4 motores TU1-TU3, r.o. 0320.S2+0320.L3</p>	<p><i>¡Nuevo!</i></p>  <p><b>3698</b> juego tapas correa distribución 1.9D (-'99) motor XUD, r.o. 0320.H2+0320.H3+0320.F9</p>	<p><i>¡Nuevo!</i></p>  <p><b>3699</b> juego tapas correa distribución 2.0HDi motor DW10, r.o. 0320.N5/N6/S7</p>
<p><i>¡Nuevo!</i></p>  <p><b>3700</b> juego tapas correa distribución 1.9D ('99-) motor DW8, r.o. 0320.N3+0320.X6+0320.N4</p>	<p><i>¡Nuevo!</i></p>  <p><b>4826</b> tensor correa alternador 1.9D con A/C r.o. 5751.30</p>	<p><i>¡Nuevo!</i></p>  <p><b>4609</b> tensor correa alternador 1.9D sin A/C r.o. 5751.38</p>

## CITROËN BERLINGO

<p><b>¡Nuevo!</b></p>  <p><b>4928</b>      <b>Ø 10-60 / 25 mm</b> rodillo tensor correa alternador XUD-1.9DW sin a/c, r.o. 5751.73</p>	<p><b>¡Nuevo!</b></p>  <p><b>4995</b> rodillo tensor correa alternador 1.9DW8 y 2.0HDI con a/c, r.o. 5751.29</p>	<p><b>¡Nuevo!</b></p>  <p><b>4996</b> rodillo tensor correa alternador 2.0HDI sin a/c, r.o. 5751.96-5751.57</p>
<p><b>¡Nuevo!</b></p>  <p><b>4807</b>      <b>rodillo de Ø 70 mm</b> tensor correa alternador 2.0HDI r.o. 5751.55</p>	<p><b>¡Nuevo!</b></p>  <p><b>5043</b>      <b>rodillo de Ø 60 mm</b> tensor correa alternador 1.9DW8 sin A/C r.o. 5751.74</p>	
<p><b>¡Nuevo!</b></p>  <p><b>3651</b> tapa filtro gasoil 1.9DW8 con junta y clip de cierre, r.o. 1904.27+1904.26</p>	<p><b>¡Nuevo!</b></p>  <p><b>4915</b>      <b>Ø 54,60 mm</b> polea de alternador de rueda libre r.o.</p>	<p><b>¡Nuevo!</b></p>  <p><b>4916</b>      <b>Ø 58,50 mm</b> polea de alternador de rueda libre r.o.</p>
 <p><b>088</b> soporte tubo de escape r.o. 1755.61</p>	 <p><b>2692</b> soporte tubo de escape r.o. 1755.58</p>	 <p><b>4010</b> soporte tubo de escape desde '98 r.o. 1755.68</p>
 <p><b>749</b>      <b>Ø 69 mm</b> collarín enlace tubo de escape r.o.</p>	 <p><b>748</b>      <b>Ø 66 mm</b> collarín enlace tubo de escape r.o.</p>	 <p><b>2941</b>      <b>junta de Ø 60 x 46 mm</b> kit montaje colector 1.1-1.4 y 1.9 Diesel hasta '98, r.o.</p>
 <p><b>2940</b>      <b>junta de Ø 80 x 66 mm</b> kit montaje colector 1.7 Diesel (XUD7) r.o.</p>	 <p><b>2938</b>      <b>junta de Ø 58 x 45 mm</b> kit montaje colector 1.9 Diesel desde '98 r.o.</p>	 <p><b>2939</b>      <b>junta de Ø 74 x 58 mm</b> kit montaje colector 2.0 HDi r.o.</p>
 <p><b>2770</b> cubrepedal freno r.o. 4504.12</p>	 <p><b>2771</b> cubrepedal embrague r.o. 2130.13</p>	 <p><b>2772</b> cubrepedal acelerador r.o. 1604.07</p>

## CITROËN BERLINGO



**2050**

arandela metaloplástica 14 x 22 (2.0HDi)  
r.o.0313.27



**2051**

arandela plana 10 x 21 para tapón MC-2929  
r.o.0313.33



**4036**

bomba de cebado gasoil c/ válvula antirretorno y boquilla adicional a 90°, r.o. 1579.73



**2452**

tapón de cárter 14 x 125, todos salvo DW8  
r.o.0311.21



**2929**

tapón de cárter 10 x 125, 1.9 Diesel d/99  
r.o.0311.29



**2024**

arandela tapón de cárter con junta de goma Ø 14 mm



# CITROËN BX

## CANALIZACIONES DE AGUA

**BX - 14 desde PR 4217 (desde '89, motor TU)**

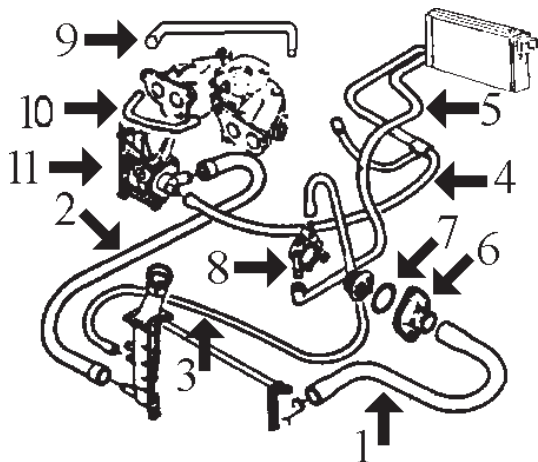

- 1- 7857 mgto superior de radiador
- 2- 7858 mgto inferior de radiador
- 3- 8077 mgto de radiador a caja termostato
- 4- 8155 mgto de calefactor a bomba y carburador (3 vias)
- 5- 7871 mgto de caja termostato a calefactor
- 6- 3011 boquilla alojamiento termostato
- 7- 2351 junta de termostato
- 8- 3081 boquilla metálica inferior en caja termostato
- 3082 boquilla metálica superior en caja termostato
- 9- 7952 mgto de carburador a colector
- 10- 7954 mgto de carburador a colector
- 11- 3578 tapa bomba de agua

mgto. desvaporizadores: MC-8167 y MC-8002

**BX - 16 / 19**

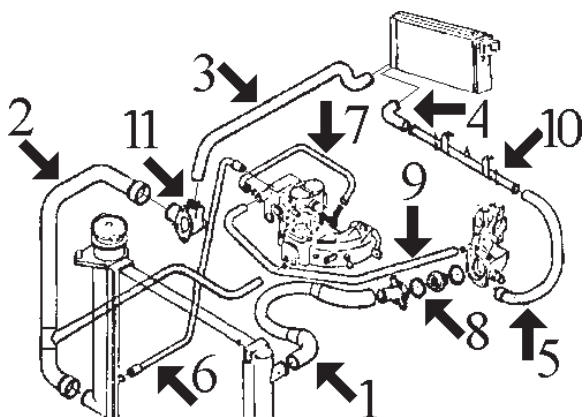

- 1- n/d mgto superior radiador hasta PR-4553 (4/'89)
- 7829 mgto superior de radiador desde PR 4554 (4/'89), 16, 19, inyección y 16v
- 2- n/d mgto inferior radiador (3 vias) carburador
- 7761 mgto inferior radiador inyección (IE) y 16V.
- 3- 7870 mgto de calefactor a bomba
- 4- n/d mgto de calefactor a tubo metálico
- 5- 7868 mgto de tubo metálico a caja termostato
- 6- 7867 mgto de radiador a carburador hasta PR 3156
- 8080 mgto de radiador a carburador desde PR 3157
- 7- 7954 mgto de colector a carburador (salvo IE y 16v.)
- 8- 3552 tapa de termostato hasta '91
- 3551 tapa de termostato desde '91
- 2350 junta de termostato
- 9- 7867 mgto de carburador a tapa de termostato
- 10- n/d tubo metálico
- 11- 3523 brida agua enlace manguitos

**BX - 1.7 y 1.9 DIESEL hasta PR 3874 (5/'87):**

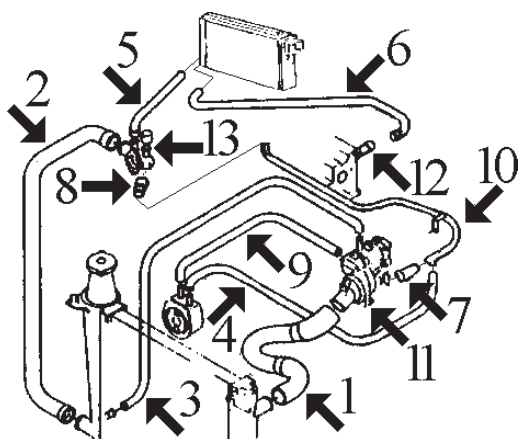

- 1- n/d mgto superior de radiador
- 2- 7761 mgto inferior de radiador
- 3- 7875 mgto de radiador a caja de termostato
- 4- n/d mgto de intercambiador a tubo metálico
- 5- n/d mgto de calefactor a bomba de agua
- 6- 7863 mgto de calefactor a culata
- 7- 7949 mgto de tubo metálico a caja de termostato
- 8- 7948 mgto de tubo metálico a bomba de agua
- 9- n/d mgto de intercambiador a caja de termostato
- 10- 3019 tubo de agua metálico hasta '89
- 11- 3616 tapa de termostato
- 3171 boquilla metálica en caja termostato
- 12- 3059 boquilla metálica clavada en culata
- 13- 3503 brida plástica conexión manguitos

## BX - 1.9 DIESEL desde PR 3875 (6/'87):

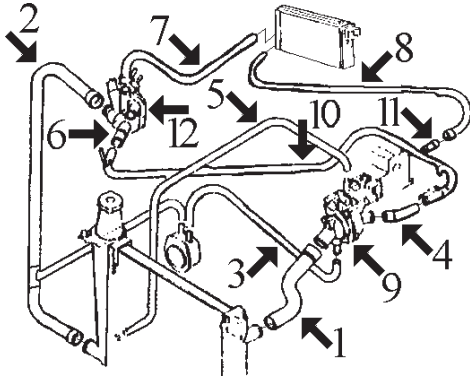

- 1- n/d mgto superior de radiador
- 2- 8156 mgto inferior de radiador (3 vias)
- 3- 8062 mgto de intercambiador a caja de termostato
- 4- 7949 mgto de tubo metálico a caja de termostato
- 5- 7875 mgto de radiador a caja de termostato
- 6- 7948 mgto de tubo metálico a bomba de agua
- 7- 7870 mgto de calefactor a bomba de agua
- 8- 7863 mgto de calefactor a culata
- 9- 3539 tapa de termostato
- 3171 boquilla metálica en caja de termostato
- 10- 3134 tubo de agua metálico desde '89 hasta '91
- 3057 tubo de agua metálico desde '91
- 11- 3059 boquilla metálica clavada en culata
- 12- 3503 brida plástico conexión manguitos

## BX - TURBODIESEL:

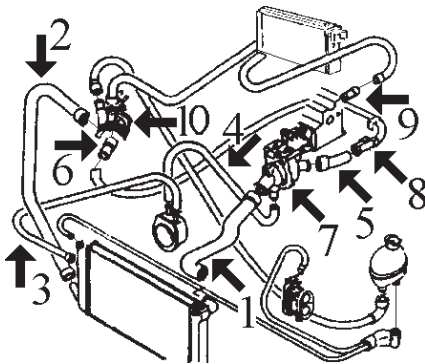

- 1- n/d mgto superior de radiador
- 2- 7770 mgto inferior de radiador
- 3- 8159 mgto de radiador a intercambiador
- 4- 8062 mgto de intercambiador a caja de termostato
- 5- 7949 mgto de tubo metálico a caja de termostato
- 6- 7948 mgto de tubo metálico a bomba de agua
- 7- 3539 tapa de termostato
- 3171 boquilla metálica en caja de termostato
- 8- 3057 tubo metálico
- 9- 3059 boquilla metálica en culata
- 10- 3503 brida plástico conexión manguitos

## MANGUITOS DESVAPORIZADORES (sintéticos):

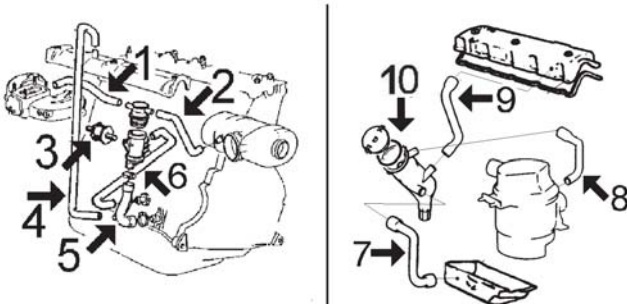

### motor XU carburador e inyección:

- 1- 8320 de tapón de llenado a colector
- 2- 8305 de tapón de llenado a filtro de aire
- 3- 4490 soporte elástico decantador
- 4- 8304 de tapa balancines a tubo del cárter
- 5- 8187 de decantador a cárter motor (3 vias)
- 6- 8309 de decantador a cárter motor

### motor Diesel:

- 7- 8166 de decantador a cárter motor
- 8- 8167 de decantador a filtro de aire (excepto TurboD)
- 9- 8165 de decantador a tapa de balancines
- 10- 3631 decantador completo con tapón

## CITROËN BX



**7761**  
mgto inferior radiador 1.6 IE - 16v y D.  
sel 1ª s., r.o. 95587690



**7770**  
mgto inferior radiador TurboD  
r.o. 95638588



**7829**  
mgto superior radiador 16-19 d/PR 4554  
r.o. 95632507



**7857**  
mgto superior radiador 14 motor TU  
r.o. 96004956



**7858**  
mgto inferior radiador 14 motor TU  
r.o. 96004955



**7863**  
mgto de calefactor a culata 1.9D d/PR 3875  
r.o. 95636313



**7868**  
mgto de tubo metálico a termostato 16-19  
r.o. 95630844



**7870**  
mgto calefactor a bomba 16-19 y Diesel 2ª s.  
r.o. 95630937 - 96162612



**7871**  
mgto de termostato a calefactor 14-TU  
r.o. 96014521



**7875**  
mgto de radiador a termostato 1.9 Diesel  
r.o. 91538413



**7948**  
mgto de tubo metálico a bomba D-TD  
r.o. 96023032



**7949**  
mgto de tubo metálico a termostato D-TD  
r.o. 93510787 - 1307-J4



**7952**  
mgto de carburador a colector 14TU  
r.o. 95636723



**7954**  
mgto de carburador a colector 14 - TU  
r.o. 1413.94



**8062**  
mgto de intercamb. a termost. 1.9 D-TD  
r.o. 1307.J5



**8077**  
mgto de radiador a termostato 14 - TU  
r.o. 95659500



**8080**  
mgto de radiador a carburador 16-19 d/  
PR 3157, r.o. 95592034













**8155**  
mgto de calefactor a bomba 14 motor TU  
r.o. 96014523



**8156**  
mgto inferior radiador 1.9D d/PR 3875  
r.o. 95640596

## CITROËN BX

 <p><b>8159</b> mgto de radiador a intercambiador TurboD r.o. 96015636</p>	 <p><b>8165</b> mgto desvaporizador Diesel r.o. 1192.49</p>	 <p><b>8166</b> mgto desvaporizador Diesel r.o. 1192.48</p>
 <p><b>8167</b> mgto desvaporizador Diesel y 14 TU r.o. 1192.61 - 1192.69</p>	 <p><b>8187</b> mgto desvaporizador 16-19 (motor XU) r.o. 1180.25</p>	 <p><b>8304</b> mgto desvaporizador 16-19 (motor XU) r.o. 96099647 - 1180.34</p>
 <p><b>8305</b> mgto desvaporizador 16-19 (motor XU) r.o. 96096800 - 1192.66</p>	 <p><b>8309</b> mgto desvaporizador 16-19 (motor XU) r.o. 96100920 - 1180.34</p>	 <p><b>8320</b> mgto desvaporizador 16-19 (motor XU) r.o. 96084132 - 1195.56</p>
 <p><b>8002</b> mgto desvaporizador 14 TU r.o. 1192.62</p>	 <p><b>2351</b>      Ø 41 x 47 junta de termostato 1.4 motor TU r.o. 97523016</p>	



## CITROËN BX



**3011**

boquilla alojamiento termostato 14 - TU  
r.o. 97523152



**3019**

tubo metálico 1.7 D - 1.9 D hasta PR 3874  
r.o. 93501755 - 1213.29



**3057**

tubo metálico 1.7D-1.9D desde PR3875 y TurboDiesel, r.o. 1307.W2



**3059**

boquilla en culata Diesel y TD  
r.o. 93010296



**3081**

boquilla en caja termostato 1.4 TU  
r.o. 96064657



**3082**

boquilla en caja termostato 1.4 TU  
r.o. 96064659



**3134**

tubo de agua metálico Diesel d/ '89 a '91  
r.o. 1213.31



**3171**

boquilla en caja termostato Diesel XU  
r.o. 1336.N7



**3503**

con junta tórica  
brida plástico conexión mgts Diesel y TD  
r.o. 1336.G4 + 1340.28



**3523**

con junta tórica  
brida plástico conexión mgts. 16-19 "XU"  
r.o. 1336.H7 + 1339.79



**3578**

tapa bomba de agua 1.4 TU  
r.o. 1201.66



**3539**

tapa de termostato 1.9D-TD desde '89  
r.o. 1336.C9



**3551**

Ø base 56 mm  
tapa de termostato 1.6-1.9 desde '91  
r.o. 1336.88



**3552**

Ø base 53 mm  
tapa de termostato 1.6-1.9 hasta '91  
r.o. 1336.G1



**3616**

tapa de termostato 1.7-1.9 Diesel hasta '89  
r.o. 1336.E8



**3608**

tapón radiador (1.2 bar)  
r.o.



**3631**

decantador completo con tapón 1.9D-TD  
r.o.



**4490**

soporte desvaporizador (motores gasolina)  
r.o. 1439.10

## SUSPENSION DELANTERA Y SOPORTES DE MOTOR

**BX-14 hasta '89 "motor plano"**

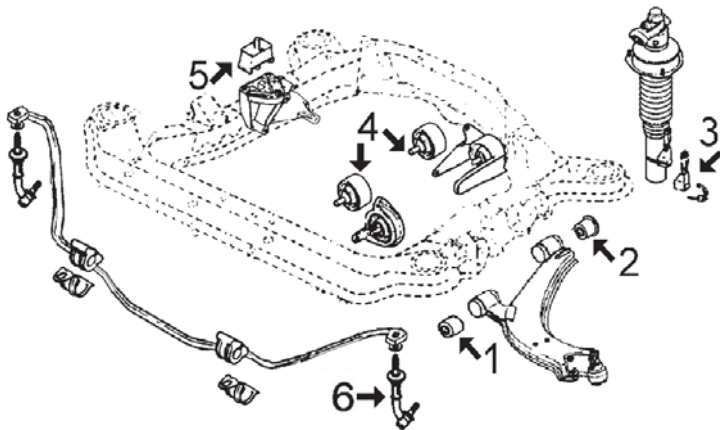

- 1- 940 silentbloc anterior trapecio delantero
- 2- 941 silentbloc posterior trapecio delantero
- 3- 944 juego recuperador líquido de suspensión y abrazadera de fijación
- 4- 831 soporte de motor derecho
- 5- n/d silentbloc para soporte de motor delantero izquierdo y trasero izquierdo
- 6- 4398 bieleta puntal barra estabilizadora

**BX-14 (desde 5/'88 motor TU) - BX-16 / 19 - DIESEL y TURBODIESEL**

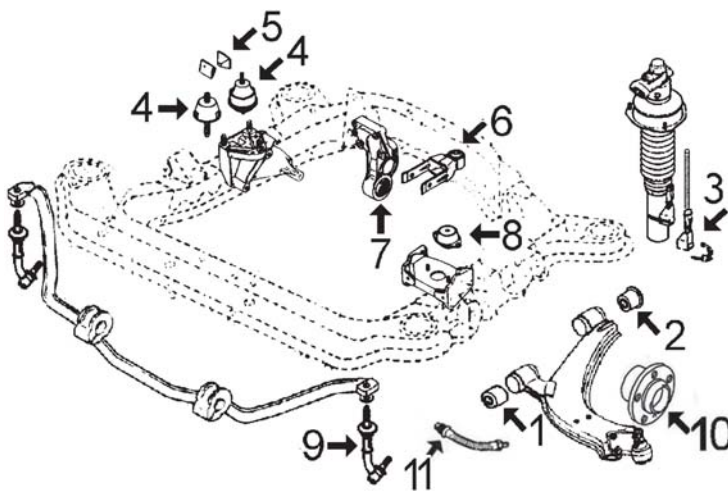

- 1- 940 silentbloc anterior trapecio delantero
- 2- 941 silentbloc posterior trapecio delantero
- 3- 944 juego recuperador líquido suspensión y abrazadera de fijación
- 4- 697 soporte de motor derecho 16-19 y Diesel desde '87 y 14 motor TU
- 5- 724 limitador elástico soporte de motor derecho 16-19 y Diesel hasta PR 4216 (5/'88)
- 905 limitador elástico soporte de motor derecho 16-19 y Diesel desde PR 4127 y 14 motor TU
- 6- 4744 tirante trasero de motor completo XU y 1.7D
- 4743 tirante trasero de motor completo 1.4TU
- 877 silentbloc bieleta tirante soporte trasero
- 7- 694 silentbloc soporte trasero 16-19 y Diesel
- 751 silentbloc soporte trasero 14 motor TU
- 8- 531 soporte de motor izquierdo salvo 14-TU
- 2786 soporte motor izquierdo 14-TU
- 9- 4398 bieleta puntal barra estabilizadora
- 10- 90012 buje de rueda delantera desde '89
- 11- 96107 latiguillo freno delantero

## SUSPENSION TRASERA:

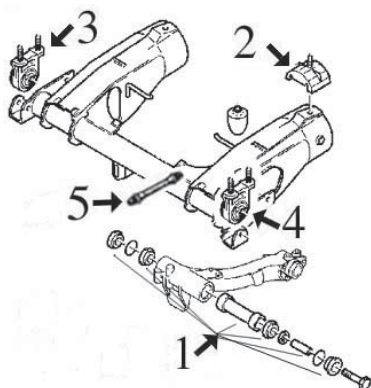

- 1- 2684 juego reparación articulación brazo trasero completo (11 piezas)
- 2- 4943 soporte brazo trasero suspensión
- 3- 2909 soporte derecho puente trasero
- 4- 2910 soporte izquierdo puente trasero
- 5- n/d latiguillo freno trasero (210 mm)

## CITROËN BX



**940**  
silentbloc anterior trapecio delantero  
r.o. 95637690



**941**  
silentbloc posterior trapecio delantero  
r.o. 96070064



**831**  
soporte de motor dcho. BX-14 hasta '89  
(motor plano), r.o. 95589715



**905**  
limitador soporte motor derecho desde '89  
r.o. 1844.17



**4398**  
bieleta puntal barra estabilizadora  
r.o.



**697** **hidráulico**  
soporte de motor dcho. 1.6-1.9 desde '87  
r.o. 1844.42



**724**  
limitador soporte dcho. 1.6-1.9 hasta '87  
r.o. 97521102



**2786**  
soporte motor izquierdo 1.4-TU  
r.o. 96104506



**531**  
soporte motor izquierdo todos salvo 1.4  
r.o. 1843.95

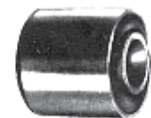

**877**  
silentbloc tirante soporte motor trasero  
r.o. 1809.04 (12x30x28x34)

**¡Nuevo!**



**4743**  
tirante trasero de motor completo 1.4TU  
r.o.

**¡Nuevo!**



**4744**  
tirante trasero de motor completo XU-XUD  
r.o. 1854.16



**96107**  
latiguillo freno delantero  
r.o.



**694** **Ø 70 mm**  
silentbloc soporte trasero motor 16-19 y D.  
r.o. 1809.16



**751** **Ø 65 mm**  
silentbloc soporte trasero motor 14 (TU)  
r.o.



**2684**  
juego reparación brazo suspensión trasero  
completo con rodamientos



**2909**  
soporte derecho puente trasero  
r.o. 95632593



**2910**  
soporte izquierdo puente trasero  
r.o. 95632592

**¡Nuevo!**



**4943**  
soporte brazo trasero suspensión  
r.o. 5149.90

## CITROËN BX



**944**  
juego recuperador líquido de suspensión  
r.o. 95622818-95612275



**2440**  
racor unión tubos conducción LHM  
r.o. 5270.14



**90012**  
buje de rueda delantera  
r.o. 3307.69



**1307**  
fuelle Dc + Iz cremallera manual y Iz asis-  
tida, r.o. 95604346

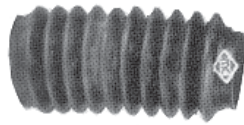

**1308**  
fuelle derecho cremallera asistida  
r.o. 95496072



**844**  
capuchón derecho cremallera asistida  
r.o. 4066.16



**374**  
flector de dirección  
r.o. 95631286

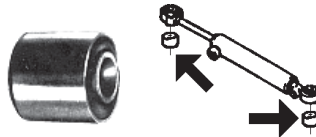

**2410**  
silentbloc piston cremallera asistida  
r.o.

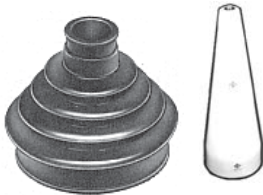

**1340E**  
kit rep. transm. l/rueda 14-16-19h/PR4056  
(montaje con cono-útil neumático)

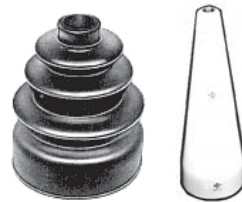

**1493E**  
kit rep. transm. l/rda para montar en cono  
en neopreno especial de elasticidad 800%



**1493**  
kit rep. transm. l/rueda 16-19 d/PR 4056  
r.o. 96009166



**1708**  
kit rep. transm. l/rda GTI-IE y TurboD  
r.o. 3293.91

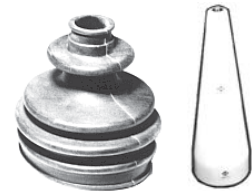

**1708E**  
kit rep. transmisión l/rda GTI-TD  
**se puede montar con cono, r.o. 3293.91**



**1362**  
kit rep. transm. l/cambio 16-19-D y TD  
r.o. 95025088



**1556**  
kit fuelle transmisión l/cambio 1360 cc  
(cárter de Ø70, largo 78 mm), 95565567



**4564** **Ø 30/47 y 40/58 mm**  
juego de retenes diferencial-transmisión  
r.o. 3124.44+3124.46

long. máx: 135 mm  
long. mín: 90 mm

long. máx: 300 mm  
long. mín: 265 mm

long. máx: 190 mm  
long. mín: 170 mm



**2347**  
bieleta reenvío cambio velocidades  
(rótula de Ø 10), r.o. 2454.74-2454.94













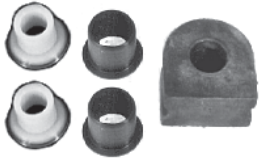





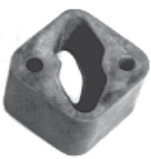

**2348**  
bieleta reenvío cambio velocidades  
(rótula de Ø 13), r.o. 2444.82



**2376**  
bieleta reenvío cambio velocidades  
(rótula de Ø 10), r.o. 95631090

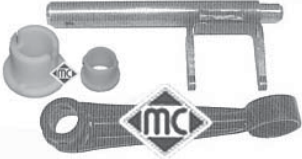

## CITROËN BX

<p>long. 52 mm a 67 mm</p>  <p><b>2407</b> bieleta reenvío cambio velocidades (rótula de Ø 10), r.o. 95578973</p>	 <p><b>2409</b> juego casquillos palanca de cambio y selector, r.o. 7910005487-95589866-95589882</p>	 <p><b>2392</b> <span style="float: right;">Ø 46.2 mm</span> kit montaje colector escape 14-16-19 y D r.o.</p>
 <p><b>2390</b> <span style="float: right;">Ø 58.2 mm</span> kit montaje colector de escape TurboDiesel r.o.</p>	 <p><b>2391</b> <span style="float: right;">Ø 66 mm</span> kit montaje colector de escape GTI-IE-16v. r.o. 1798.54</p>	 <p><b>2393</b> junta cónica tubo de escape Ø 46.2 mm 14-16-19 y Diesel, r.o. 95602682</p>
 <p><b>2394</b> junta cónica tubo de escape Ø 58.4 mm TurboDiesel, r.o. 96587799</p>	 <p><b>2395</b> junta cónica tubo de escape Ø 66 mm GTI-IE y 16v, r.o. 96038954</p>	 <p><b>748</b> <span style="float: right;">Ø 66 mm</span> collarín tubo de escape r.o. 95483762</p>
 <p><b>749</b> <span style="float: right;">Ø 69 mm</span> collarín tubo de escape r.o.</p>	 <p><b>2417</b> soporte tubo de escape r.o. 95640799</p>	 <p><b>4036</b> bomba manual cebado gasoil r.o. 1579.73</p>
 <p><b>2335</b> varilla nivel aceite 1360 cc motor TU r.o. 1174.10</p>	<p><i>Nuevo!</i></p>  <p><b>4612</b> varilla nivel aceite 1.9 Diesel XUD9 r.o. 1174.15</p>	<p><i>Nuevo!</i></p>  <p><b>4672</b> varilla nivel aceite 1.6-1.9 gasolina XU r.o. 1172.79</p>
 <p><b>3639</b> tapón llenado aceite motor 1.4 TU r.o. 0258.55</p>	 <p><b>2848</b> <span style="float: right;">Ø 142 mm - 5 canales</span> polea cigüeñal 1.7 Diesel (compatible con 4 canales) r.o. 0515.K9</p>	 <p><b>2926</b> <span style="float: right;">Ø 156 mm - 6 canales</span> polea cigüeñal 1.9 Diesel y TurboD r.o. 0515.G3</p>
 <p><b>4300</b> horquilla embrague completa motor TU con casquillos, r.o. 2117.52</p>	 <p><b>4057</b> jgo casquillos horquilla embrague motor TU r.o. 2175.11+2175.12</p>	 <p><b>4052</b> horquilla embrague completa motor XU con casquillos, r.o. 2115.25</p>

## CITROËN BX

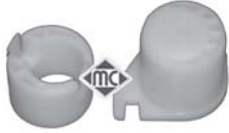

**4043**

jgo casquillos horquilla embrague motor XU  
r.o. 2175.20+2175.21

**¡Nuevo!**



**4424**

casquillo guía embrague 1.4 TU  
r.o. 2105.14

**¡Nuevo!**



**4605**

casquillo guía embrague 1.6-1.9 y Diesel  
r.o. 2105.35



**667**

tapón cárter de aceite 16x150  
r.o. 7830197000



**2025**

arandela tapón de cárter con retén goma  
Ø16x24mm, r.o. 97532428



**942**

funda protectora Delco  
r.o. 5966.16

**SUSPENSION DELANTERA y SOPORTES de MOTOR:**

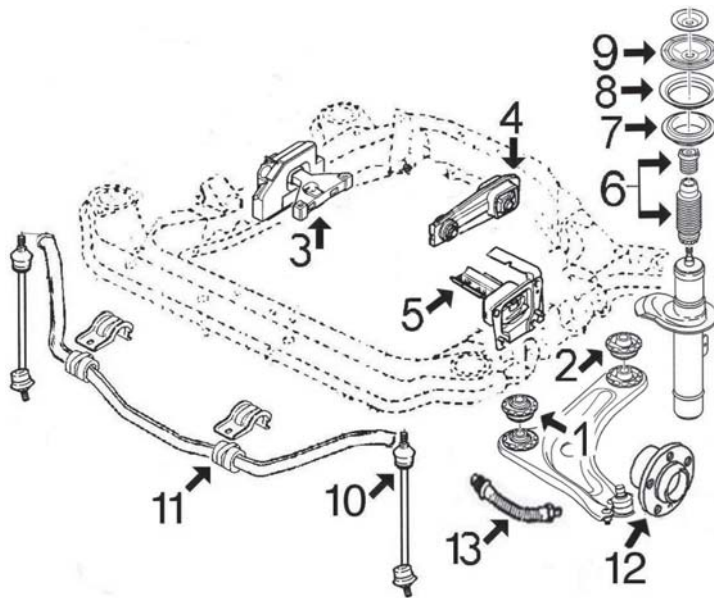





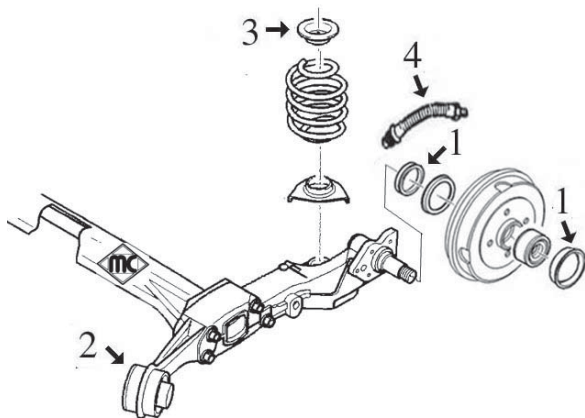







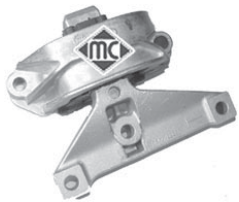
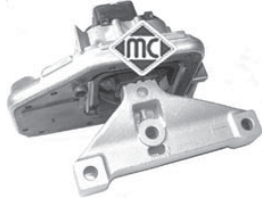



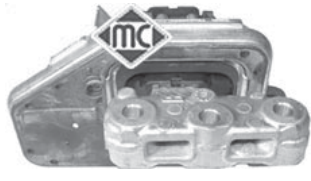

- 1- 4651 silentbloc anterior trapecio delantero
- 2- 4652 silentbloc posterior trapecio delantero
- 3- 4643 soporte motor derecho 1.1TU
- 4643 soporte motor derecho 1.4TU hasta 6/'02
- 4644 soporte motor derecho 1.4TU desde 6/'02
- 4645 soporte motor derecho 1.4/16v ET3J4
- 4646 soporte motor derecho 1.6/16v TU5JP4
- 4647 soporte motor derecho 1.4HDi/8v DV4TD
- 4648 soporte motor derecho 1.4HDi/16v DV4TED4
- 4- 4650 soporte motor trasero
- 5- 4649 soporte motor izquierdo
- 6- 4657 juego capuchón y tampón amortiguador
- 7- n/d apoyo superior muelle delantero
- 8- 4181 rodamiento soporte amortiguador delantero
- 9- 4668 soporte amortiguador delantero
- 10- 4068 bieleta puntal barra estabilizadora
- 11- 4656 goma barra estabilizadora
- 12- 90045 buje rueda delantera
- 13- 96152 latiguillo freno delantero (479 mm)

**SUSPENSION TRASERA:**





















- 1- 4828 juego retén eje trasero y tapa tambor
- 2- 4831 silentbloc soporte puente trasero
- 3- n/d soporte superior amortiguador trasero
- 4- 96154 latiguillo freno trasero (212 mm)

## CITROËN C3















<p><b>¡Nuevo!</b></p>  <p><b>4068</b> bieleta puntal barra estabilizadora r.o.5087.45</p>	<p><b>¡Nuevo!</b></p>  <p><b>4181</b> rodamiento soporte amortiguador delantero r.o.5035.27</p>	<p><b>¡Nuevo!</b></p>  <p><b>4643</b> soporte motor derecho 1.1-1.4TU r.o.</p>
<p><b>¡Nuevo!</b></p>  <p><b>4644</b> soporte motor derecho 1.4TU desde 6/02 r.o.</p>	<p><b>¡Nuevo!</b></p>  <p><b>4645</b> soporte motor derecho 1.4/16v r.o.</p>	<p><b>¡Nuevo!</b></p>  <p><b>4646</b> soporte motor derecho 1.6/16v r.o.</p>
<p><b>¡Nuevo!</b></p>  <p><b>4647</b> soporte motor derecho 1.4HDi/8v r.o.</p>	<p><b>¡Nuevo!</b></p>  <p><b>4648</b> soporte motor derecho 1.4HDi/16v r.o.</p>	<p><b>¡Nuevo!</b></p>  <p><b>4649</b> soporte motor izquierdo r.o.</p>
<p><b>¡Nuevo!</b></p>  <p><b>4650</b> soporte motor trasero r.o.</p>	<p><b>¡Nuevo!</b></p>  <p><b>4651</b> silentbloc anterior trapecio delantero r.o.3523.98</p>	<p><b>¡Nuevo!</b></p>  <p><b>4652</b> silentbloc posterior trapecio delantero r.o.3523.AA</p>
<p><b>¡Nuevo!</b></p>  <p><b>4656</b> goma barra estabilizadora r.o.</p>	<p><b>¡Nuevo!</b></p>  <p><b>4657</b> juego capuchón y tampón amortiguador delantero, r.o.</p>	<p><b>¡Nuevo!</b></p>  <p><b>4668</b> soporte amortiguador delantero r.o.</p>
<p><b>¡Nuevo!</b></p>  <p><b>4828</b> juego retén eje trasero y tapón tambor r.o.3724.24+3740.19</p>	<p><b>¡Nuevo!</b></p>  <p><b>4829</b> silentbloc soporte eje trasero r.o.5131.C1</p>	<p><b>¡Nuevo!</b></p>  <p><b>90045</b> bujе rueda delantera r.o.3307.76</p>
<p><b>¡Nuevo!</b></p>  <p><b>96152</b> latiguillo freno delantero (479 mm) r.o.4806.A9</p>	<p><b>¡Nuevo!</b></p>  <p><b>96154</b> latiguillo freno trasero (212 mm) r.o.4806.C0</p>	



## CITROËN C3

 <p><b>3560</b> tapón botella expansión r.o. 1306.E4</p>	 <p><b>3611</b> tapa con termostato 1.4 r.o. 1336.Q2</p>	 <p><b>3620</b> tapa con termostato 1.1 r.o. 1336.N5</p>
<p><i>¡Nuevo!</i></p>  <p><b>3640</b> boquilla en bomba de agua 1.6/16v r.o. 1201.C3</p>	<p><i>¡Nuevo!</i></p>  <p><b>3641</b> tapa bomba de agua 1.1-1.4TU r.o. 1201.C2</p>	<p><i>¡Nuevo!</i></p>  <p><b>3697</b> juego tapas correa distribución 1.1-1.4 motores TU1-TU3, r.o. 0320.S2+0320.L3</p>
<p><i>¡Nuevo!</i></p>  <p><b>4066</b> horquilla embrague 1.4HDi-16v con mando embrague por cable, r.o. 2117.58</p>	<p><i>¡Nuevo!</i></p>  <p><b>4600</b> horquilla embrague 1.1-1.4-1.6 r.o. 2117.61</p>	<p><i>¡Nuevo!</i></p>  <p><b>4601</b> horquilla embrague 1.4HDi-16v con mando embrague hidráulico, r.o. 2117.66</p>
<p><i>¡Nuevo!</i></p>  <p><b>4796</b> casquillo guía embrague r.o. 2105.38</p>	<p><i>¡Nuevo!</i></p>  <p><b>3659</b> tapón llenado aceite 1.6/16v r.o. 0258.65</p>	<p><i>¡Nuevo!</i></p>  <p><b>3639</b> tapón llenado aceite 1.1-1.4TU (8v) r.o. 0258.55</p>
<p><i>¡Nuevo!</i></p>  <p><b>4593</b> varilla nivel aceite 1.1-1.4TU r.o.</p>	<p><i>¡Nuevo!</i></p>  <p><b>4739</b> varilla nivel aceite 1.6/16v r.o.</p>	<p><i>¡Nuevo!</i></p>  <p><b>4740</b> varilla nivel aceite 1.4HDi r.o.</p>
<p><i>¡Nuevo!</i></p>  <p><b>4442</b> polea cigueñal 1.4/16v-1.6/16v hasta 7/'04 r.o. 0515.P1</p>	<p><i>¡Nuevo!</i></p>  <p><b>4440</b> polea cigueñal 1.4/16v-1.6/16v desde 7/'04 r.o. 0515.R8</p>	<p><i>¡Nuevo!</i></p>  <p><b>4441</b> polea cigueñal 1.4HDi r.o. 0515.R0-0515.T0</p>

## CITROËN C3

<p><b>¡Nuevo!</b></p>  <p><b>1121</b> fuelle cremallera dirección r.o.</p>	<p><b>¡Nuevo!</b></p>  <p><b>4564</b> juego retenes diferencial-trásmisión r.o.3121.44+3121.46</p>	 <p><b>1427</b> kit rep transm. l/rueda hasta 12/02 r.o.3293.20</p>
<p><b>¡Nuevo!</b></p>  <p><b>1109</b> kit rep transm. l/rueda <b>derecha</b> desde 12/02 r.o.3293.35</p>	 <p><b>1433</b> kit rep transm l/rueda <b>izquierda</b> desde 12/02 r.o.3293.A3</p>	 <p><b>1428</b> kit rep transmisión <b>derecha</b> l/cambio r.o.3287.88-3287.93</p>
<p><b>¡Nuevo!</b></p>  <p><b>1142</b> kit rep transmisión <b>izquierda</b> l/cambio r.o.3287.94</p>	<p><b>¡Nuevo!</b></p>  <p><b>4653</b> soporte posterior derecho silenciador r.o.1755.J3-1755.F2-1755.J6</p>	<p><b>¡Nuevo!</b></p>  <p><b>4654</b> soporte posterior izquierdo silenciador r.o.1755.F3-1755.J4-1755.J5</p>
<p><b>¡Nuevo!</b></p>  <p><b>4655</b> soporte anterior tubo escape r.o.1755.F4-1755.J7-1755.J8</p>	<p><b>¡Nuevo!</b></p>  <p><b>4065</b> kit montaje colector escape 1.1-1.4 r.o.1797.10</p>	 <p><b>2452</b> tapón cárter aceite 14x125 r.o.0311.25</p>
 <p><b>2050</b>                      <b>14 x 22 mm</b> arandela metaloplástica tapón cárter r.o.0313.27</p>	 <p><b>2024</b> arandela metal-goma 14 mm r.o.</p>	<p><b>¡Nuevo!</b></p>  <p><b>4069</b> cubrepedal freno y embrague r.o.</p>

## SUSPENSION DELANTERA y SOPORTES DE MOTOR:

1.8/16v gasolina motor EW7J4  
 2.0/16v gasolina motor EW10J4  
 2.0HDi de 90CV motor DW10TD:

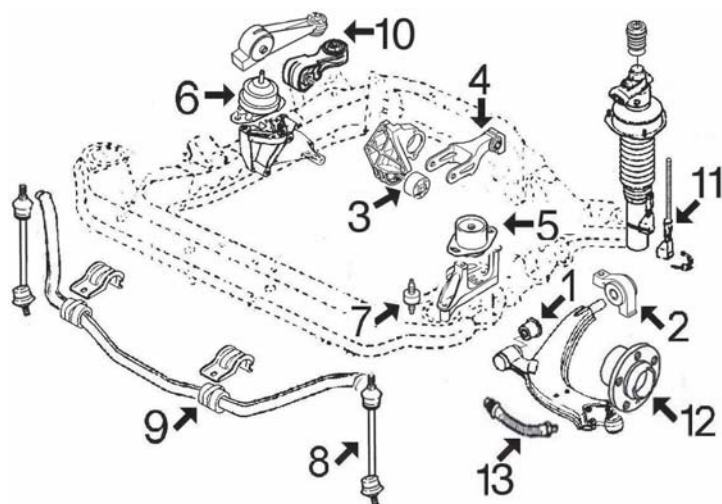

- 1- 4658 silentbloc anterior trapecio delantero completo con arandela
- 2- 4659 silentbloc posterior trapecio delantero
- 3- 4428 silentbloc soporte de motor trasero
- 4- 4662 tirante posterior motor
- 5- 2794 soporte de motor izquierdo
- 6- 2942 soporte motor derecho
- 7- 4660 silentbloc soporte anclaje del soporte motor izqd.
- 8- 4046 bieleta puntal barra estabilizadora
- 9- 4661 goma barra estabilizadora
- 10- 4614 bieleta antipar 1.8-2.0 gasolina  
4005 bieleta antipar 2.0HDi de 90CV
- 11- 2867 goma retorno liquido suspensión con abrazadera
- 12- 90066 buje rueda delantera
- 13- 96170 latiguillo freno delantero

2.0HDi de 110CV motor DW10ATED  
 2.2HDi motor DW12TED4

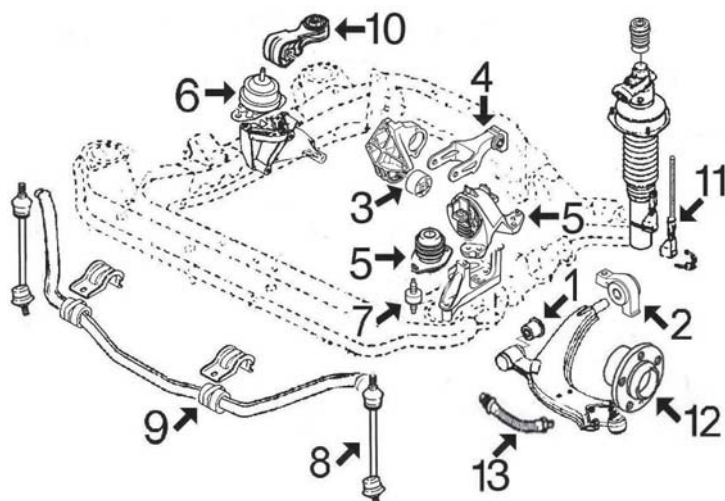

- 1- 4658 silentbloc anterior trapecio delantero completo con arandela
- 2- 4659 silentbloc posterior trapecio delantero
- 3- 2980 silentbloc soporte de motor trasero
- 4- 4662 tirante posterior motor
- 5- 4663 soporte de motor izquierdo cambio manual de 5 v. y 2.2Hdi automático  
4613 soporte de motor izquierdo cambio manual de 6 v.  
2794 soporte de motor izquierdo 2.0Hdi automático
- 6- 2942 soporte motor derecho
- 7- 4660 silentbloc soporte anclaje del soporte motor izqd.
- 8- 4046 bieleta puntal barra estabilizadora
- 9- 4661 goma barra estabilizadora
- 10- 4005 bieleta antipar
- 11- 2867 goma retorno liquido suspensión con abrazadera
- 12- 90066 buje rueda delantera
- 13- 96201 latiguillo freno delantero

## CITROËN C5



**2794**

soporte motor izquierdo 1.8-2.0-2.0HDi/90cv  
r.o.



**2867**

goma retorno líquido LHM con abrazadera  
r.o.



**2942**

soporte motor derecho 1.8-2.0-2.0HDi/90cv  
r.o.



**2980**

silentbloc soporte motor trasero 2.0/2.2 HDi  
r.o.



**4005**

bieleta antipar 2.0/2.2 HDi  
r.o.



**4046**

bieleta puntal barra estabilizadora  
r.o.

**¡Nuevo!**



**4428**

silentbloc soporte trasero motor 1.8-2.0 y  
2.0HDi de 90cv, r.o.

**¡Nuevo!**



**4613**

soporte motor izqdo. 2.0/2.2 HDi con cambio  
manual de 6v., r.o.

**¡Nuevo!**



**4614**

bieleta antipar 1.8-2.0 gasolina  
r.o.

**¡Nuevo!**



**4658**

silentbloc anterior trapecio delantero con  
arandela de fijación, r.o.

**¡Nuevo!**

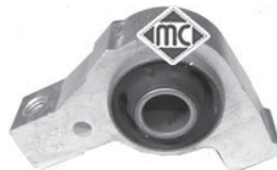

**4659**

silentbloc posterior trapecio delantero  
r.o.

**¡Nuevo!**

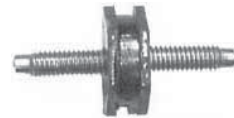

**4660**

silentbloc anclaje del soporte motor izqdo.  
r.o.

**¡Nuevo!**



**4661**

goma barra estabilizadora  
r.o.

**¡Nuevo!**



**4662**

tirante posterior de motor completo  
r.o.

**¡Nuevo!**



**4663**

soporte motor izqdo. 2.0HDi con cambio  
manual de 5v y 2.2HDi automático

**¡Nuevo!**



**90066**

buje rueda delantera  
r.o.

**¡Nuevo!**



**96170**

latiguillo freno delantero  
r.o.4806.97

**¡Nuevo!**



















**96201**









latiguillo freno trasero  
r.o.4806.98



## CITROËN C5

 <p><b>2928</b> pola cigueñal 2.0 HDi hasta '7/'02 r.o.0515.P2</p>	 <p><b>4477</b> polea cigueñal 2.0 HD-2.2 HDi i desde 7/'02 r.o.0515.R2</p>	 <p><b>4738</b> polea cigueñal 2.0 HDi-16v (desde 9/'04) r.o.0515.Q8</p>
 <p><b>4562</b> polea cigueñal 1.8/16v-2.0/16v (motor EW) r.o.0515.R1</p>	 <p><b>4443</b> polea cigueñal 2.0/16v motor EW desde '04 r.o.0515.N3</p>	 <p><b>4601</b> horquilla embrague 1.8/2.0/2.2 motor EW r.o.2117.66</p>
 <p><b>4799</b> horquilla embrague completa 2.0 HDi-2.2 HDi r.o.2117.59</p>	 <p><b>4044</b> juego casq. horquilla embrague con retenes 2.0 HDi-2.2 HDi, r.o.2175.49-2109.53</p>	 <p><b>4605</b> casquillo guía embrague con retén r.o.2105.35</p>
 <p><b>4564</b>      Ø 30/47 y 40/58 mm juego retenes diferencial-transmisión 1.8-2.0 r.o.3121.44+3121.46</p>	 <p><b>4620</b>      Ø 32/50 y 40/58 mm juego retenes diferencial-transmisión 2.0 HDi-2.2 HDi, r.o.3121.24+3121.44</p>	 <p><b>4602</b> bioleta mando cambio velocidades r.o.</p>
 <p><b>4594</b> varilla nivel aceite 2.0 HDi r.o.</p>	 <p><b>3642</b> tapón llenado aceite 2.0 HDi r.o.1180.F9</p>	 <p><b>3659</b> tapón llenado aceite 1.8-2.0 r.o.0258.65</p>
 <p><b>3699</b> juego tapas correa distribución 2.0 HDi r.o.0320.N5+0320.N6+0320.S7/N7</p>	 <p><b>1113</b> kit fuelle l/rda 1.8-2.0-2.0 HDi (90cv) r.o.3293.31</p>	 <p><b>1460</b> kit fuelle l/rda 2.0 HDi (110cv)-2.2 HDi r.o.3293.02</p>
 <p><b>1213</b> kit fuelle l/cambio 1.8-2.0-2.0 HDi (90cv) r.o.3287.81</p>	 <p><b>1122</b> kit fuelle l/cbo 2.0 HDi (110cv)-2.2 HDi r.o.3287.91</p>	 <p><b>1125</b> fuelle cremallera dirección r.o.4066.64</p>

## CITROËN C5

 <p><b>3554</b> brida plástico conexión manguitos 2.0HDI-2.2HDI, r.o. 1336.P5</p>	 <p><b>2684</b> juego reparación brazo trasero completo r.o.</p>	<p><i>Nuevo!</i></p>  <p><b>4807</b> rodillo tensor correa alternador 2.0HDI r.o. 5751.55</p>
<p><i>Nuevo!</i></p>  <p><b>4995</b> rodillo tensor correa alternador 2.0HDI con A/C, r.o. 5751.29</p>	<p><i>Nuevo!</i></p>  <p><b>4996</b> rodillo tensor correa alternador 2.0HDI sin A/C, r.o. 5751.96-5751.57</p>	<p><i>Nuevo!</i></p>  <p><b>3699</b> jgo tapas correa distribución r.o. 0320.N5-0320.N6-0320.S7</p>
<p><i>Nuevo!</i></p>  <p><b>4915</b>      <b>Ø 54,60 mm</b> polea de alternador de rueda libre r.o.</p>	<p><i>Nuevo!</i></p>  <p><b>4916</b>      <b>Ø 58,50 mm</b> polea de alternador de rueda libre r.o.</p>	
 <p><b>4060</b> soporte posterior tubo de escape r.o. 1755.77</p>	 <p><b>4042</b> soporte anterior tubo de escape r.o. 1755.84</p>	 <p><b>2452</b> tapón cárter aceite 14x125 r.o. 0311.21</p>
 <p><b>2770</b> cubrepedal freno r.o. 4504.12</p>	 <p><b>2771</b> cubrepedal embrague r.o. 2130.13</p>	 <p><b>2772</b> cubrepedal acelerador r.o. 1604.07</p>
<p><i>Nuevo!</i></p>  <p><b>4479</b> juego soporte tapa motor 2.0HDI r.o. 0137.11+0137.23</p>	 <p><b>3560</b> tapón botella de expansión r.o. 1306.E4</p>	

CANALIZACIONES DE AGUA:

C-15 1124 y 1360 cc motores TU1 y TU3 de gasolina

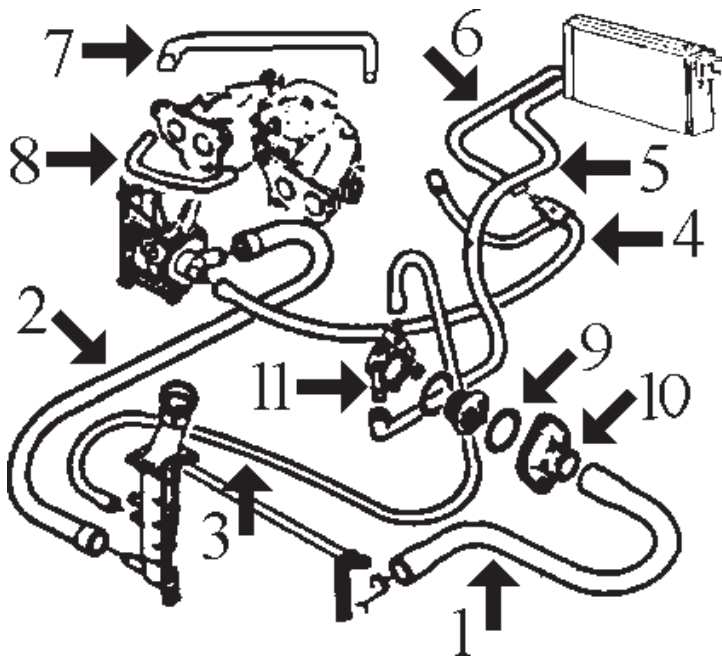

- 1- 7939 mgto superior de radiador
- 2- 7940 mgto inferior de radiador
- 3- 7950 mgto de radiador a caja de termostato
- 4- 8045 mgto de calefactor (2º tramo, 3 vias a carburador y bomba de agua, con purgador)
- 5- 7942 mgto de caja termostato a calefactor
- 6- 7941 mgto de calefactor (1er. tramo)
- 7- 7952 mgto de colector a carburador
- 8- 7953 mgto de colector a carburador motor 1124 cc  
7954 mgto de colector a carburador motor 1360 cc
- 9- 2351 junta de termostato
- 10- 3011 boquilla alojamiento termostato hasta '99  
3611 tapa con termostato desde '99
- 11- 3081 boquilla metálica inferior en caja de termostato  
3082 boquilla metálica superior en caja de termostato

mgto desvaporizadores: MC-8167 y MC-8002

C-15 1.7 DIESEL motor XUD7 hasta 5/'88

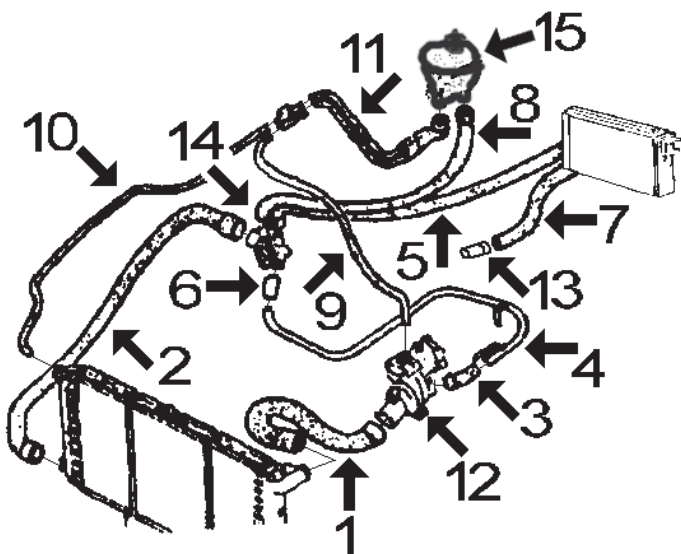

- 1- 7774 mgto superior de radiador
- 2- 7773 mgto inferior de radiador
- 3- 7947 mgto de tubo metálico a caja termostato
- 4- 3019 tubo de agua metálico
- 5- 7776 mgto de calefactor a bomba de agua
- 6- 7948 mgto de tubo metálico a bomba
- 7- 7775 mgto de calefactor a culata
- 8- 7943 mgto de botella a bomba de agua
- 9- 7944 mgto de racor 4 vias a caja termostato
- 10- 7946 mgto de racor 4 vias a radiador
- 11- 7945 mgto doble de botella a racor 4 vias
- 12- 3616 tapa de termostato  
3082 boquilla metálica clavada en tapa de termostato
- 13- 3059 boquilla metálica clavada en culata
- 14- 3503 brida de plástico conexión manguitos agua
- 15- 3595 botella de expansión  
3548 tapón botella expansión

C-15 1.7 DIESEL motor XUD7 desde 5/'88 hasta 3/'94

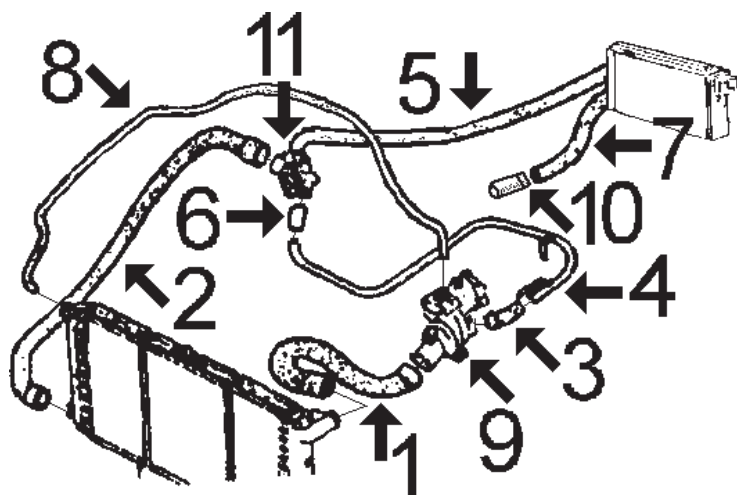

- 1- 7778 mgto superior de radiador
- 2- 7777 mgto inferior de radiador
- 3- 7949 mgto de tubo metálico a termostato hasta '91
- 8183 mgto de tubo metálico a termostato desde '91
- 4- 3134 tubo de agua metálico desde '89 hasta '91
- 3057 tubo de agua metálico desde '91
- 5- 7776 mgto de calefactor a bomba, hasta '91
- 8137 mgto de calefactor a bomba d/'91 con purgador
- 6- 7948 mgto de tubo metálico a bomba
- 7- 7775 mgto de calefactor a culata
- 8- 7950 mgto de radiador a caja de termostato hasta '91
- 8077 mgto de radiador a caja de termostato desde '91
- 9- 3616 tapa de termostato
- 3082 boquilla metálica clavada en tapa termostato
- 10- 3059 boquilla metálica clavada en culata
- 11- 3503 brida de plástico conexión manguitos agua

(mgtos desvaporizadores, ver esquema más abajo)

C-15 1.7 DIESEL motor XUD7 desde 3/'94 hasta 2/'99

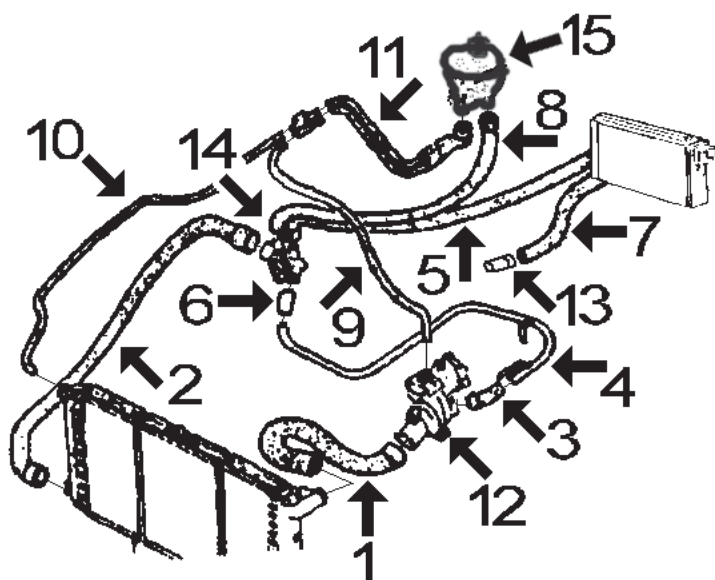

- 1- 7778 mgto superior de radiador
- 2- 8471 mgto inferior de radiador
- 3- 7947 mgto de tubo metálico a caja termostato
- 4- 3057 tubo de agua metálico
- 5- 8137 mgto de calefactor a bomba de agua
- 6- 7948 mgto de tubo metálico a bomba
- 7- 7775 mgto de calefactor a culata
- 8- 7943 mgto de botella a bomba de agua
- 9- 7946 mgto de racor 4 vias a caja termostato
- 10- 7946 mgto de racor 4 vias a radiador
- 11- 7945 mgto doble de botella a racor 4 vias
- 12- 3616 tapa de termostato
- 3082 boquilla metálica clavada en tapa de termostato
- 13- 3059 boquilla metálica clavada en culata
- 14- 3503 brida de plástico conexión manguitos agua
- 15- 3595 botella de expansión
- 3548 tapón botella expansión



C-15 1.9 DIESEL motor DW8 desde 2/'99

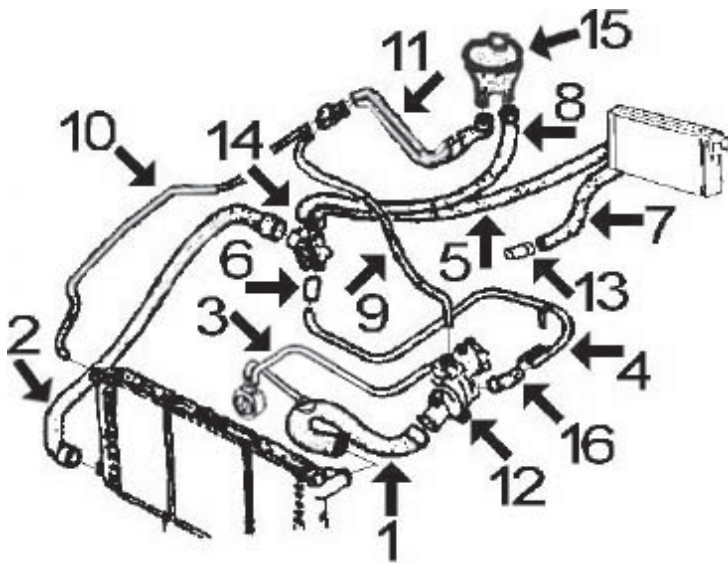

- 1- 9143 mgto superior de radiador
- 2- 8471 mgto inferior de radiador
- 3- 8478 mgto de intercambiador a caja termostato
- 4- 3057 tubo de agua metálico
- 5- 8137 mgto de calefactor a bomba de agua
- 6- 8312 mgto de tubo metálico a bomba
- 7- 7775 mgto de calefactor a culata
- 8- 9147 mgto de botella a bomba de agua
- 9- 7946 mgto de racor 4 vias a caja termostato
- 10- 7946 mgto de racor 4 vias a radiador
- 11- 7945 mgto doble de botella a racor 4 vias
- 12- 3616 tapa de termostato  
3082 boquilla metálica clavada en tapa de termostato
- 13- 3059 boquilla metálica clavada en culata
- 14- 3544 brida de plástico conexión manguitos agua
- 15- 3595 botella de expansión  
3548 tapón botella expansión
- 16- 8480 mgto de tubo metálico a caja termostato

mgts. desvaporizadores C-15 1.7 Diesel XUD7 hasta 10/'86:

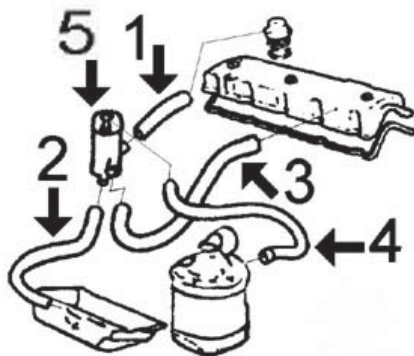

- 1- 8160 tubo a tapón de llenado
- 2- 8160 tubo a cárter de aceite
- 3- 7990 tubo a tapa de balancines
- 4- 8161 tubo a filtro de aire
- 5- 3631 decantador con tapón

mgts. desvaporizadores C-15 1.7 Diesel XUD7 desde 10/'86 hasta 5/'92

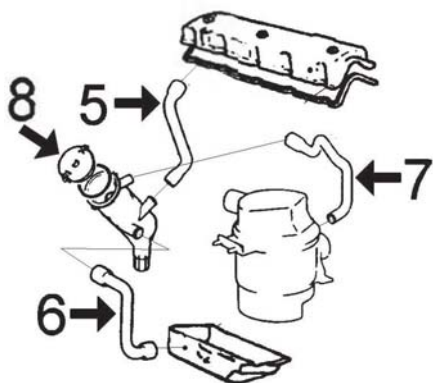

- 5- 8165 tubo a tapa de balancines
- 6- 8166 tubo a bloque motor
- 7- 8164 tubo a filtro de aire
- 8- 3631 decantador con tapón

**mgtos. desvaporizadores C-15 1.7 Diesel XUD7 desde 5/'92:**

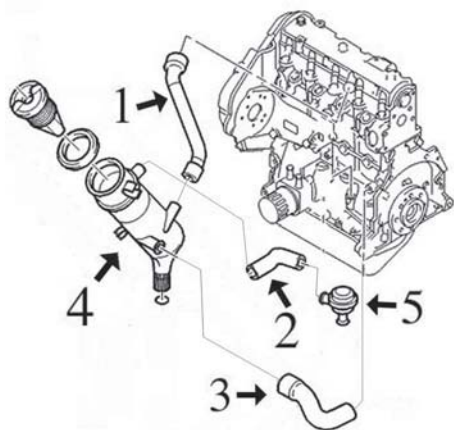

- 1- 8307 tubo de decantador a culata
- 2- 7990 tubo de decantador a válvula hasta 9/'97
- 8473 tubo de decantador a válvula desde 9/'97
- 3- 8166 tubo de decantador a tapa de balancines
- 4- 3631 decantador con tapón
- 5- 3637 válvula desvaporizadora

**mgtos. desvaporizadores C-15 1.9 Diesel DW8 desde '99:**

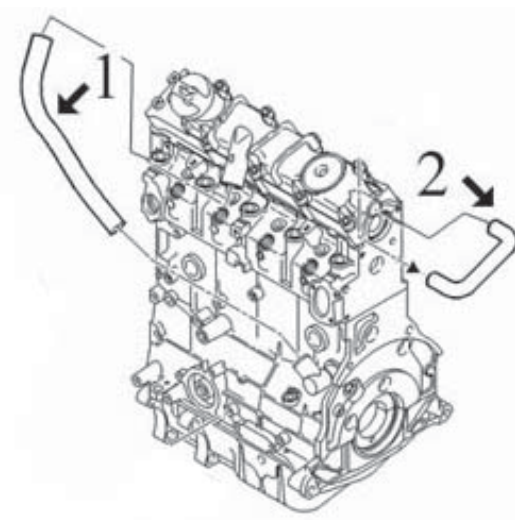

- 1- 8474 tubo de bloque motor a culata
- 2- 8475 tubo de bloque motor a culata

## CITROËN C-15



**7773**  
mgto inferior radiador Diesel y GTI h/'89  
r.o. 95593272



**7774**  
mgto superior radiador Diesel hasta '89  
r.o. 95593274



**7775**  
mgto calefactor a culata Diesel y Visa GTI  
r.o. 95593276



**7776**  
mgto calefactor a bomba Diesel y Visa GTI  
hasta '92, r.o. 95593279 - 95638650



**7777**  
mgto inferior radiador Diesel desde '89  
r.o. 96011359-96142709



**7778**  
mgto superior radiador Diesel desde '89  
r.o. 96011773-96133835



**7939**  
mgto superior radiador 1.1-1.4 TU d/'89  
r.o. 96011775



**7940**  
mgto inferior radiador 1.1-1.4 (TU) d/'89  
r.o. 96011360



**7941**  
mgto de calefactor 1.1-1.4 (TU) desde '89  
(1er. tramo), r.o. 96014856



**7942**  
mgto de termostato a calefactor 1.1-1.4  
(TU) desde '89, r.o. 96018270



**7943**  
mgto de botella a bomba Diesel  
r.o. 95592042



**7944**  
mgto de racor a termostato Diesel h/'89  
r.o. 95593281



**7945**  
mgto de botella a racor Diesel  
r.o. 95593280



**7946**  
mgto de racor a radiador Diesel  
r.o. 95593553-96995008-1307.CG



**7947**  
mgto de tubo a termostato Diesel hasta '89  
r.o. 93501397



**7948**  
mgto de tubo a bomba Diesel  
r.o. 96023032



**7949**  
mgto de tubo a termostato Diesel desde '89  
r.o. 93510787



**7950**  
mgto de radiador a termostato de '89 a '92  
r.o. 95637680



**7952**  
mgto de colector a carburador 1.1-1.4 '89  
r.o. 95636723



**7953**  
mgto de colector a carburador TU-1124 cc  
r.o. 97533257



**7954**  
mgto de colector a carburador TU-1360 cc  
r.o. 1413.94-97533256

## CITROËN C-15

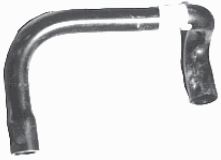

**7990**  
mgto decantador a tapa de balancines D  
r.o. 1192.C9-1192.31-91538414



**8002**  
mgto desvaporizador 1.1-1.4 TU  
r.o. 1191.13-1191.21-1192.62

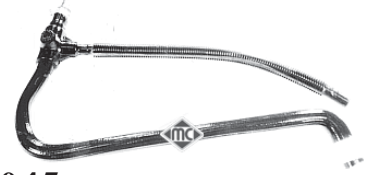

**8045**  
mgto de calefactor 1.1-1.4 desde '89  
r.o. 96012521



**8077**  
mgto de radiador a tapa termostato d/'92  
r.o. 95659500



**8137**  
mgto de calefactor a bomba Diesel d/'91  
r.o. 96142708



**8160**  
mgto de decantador a tapón y cárter  
r.o. 1192.29-1192.30



**8161**  
mgto de decantador a filtro de aire  
r.o. 95600682



**8164**  
mgto de decantador a filtro de aire Diesel  
r.o. 1192.50



**8165**  
mgto de decantador a tapa Diesel desde '87  
r.o. 1192.49



**8166**  
mgto de decantador a cárter Diesel d/'87  
r.o. 1192.48



**8167**  
mgto desvaporizador 1.1-1.4 TU  
r.o. 1192.69-1192.61



**8183**  
mgto de tubo metálico a termostato Diesel  
r.o. 1307.W38471



**8307**  
mgto desvaporizador 1.7D desde '94  
r.o. 1180.86



**8312**  
mgto de tubo metálico a brida 1.9DW8  
r.o. 1307.W4



**8471**  
mgto inferior radiador Diesel desde '93  
r.o. 1351.P3



**8473**  
mgto desvaporizador 1.7D desde '97  
r.o.



**8474**  
mgto desvaporizador 1.9DW8  
r.o. 1180.G4



**8475**  
mgto desvaporizador 1.9DW8  
r.o. 1180.G5



**8478**  
mgto de intercambiador a termost. 1.9DW8  
r.o.



**8480**  
mgto de caja termostato a tubo met. 1.9DW8  
r.o. 1180.G4



**9143**  
mgto superior radiador 1.9DW8  
r.o. 1343.EN



## CITROËN C-15

  <p><b>9147</b> mgto de botella a conector plástico 1.9DW8 r.o. 95631480</p>	 <p><b>2351</b> Ø 41 x 47 mm junta de termostato 1.1 - 1.4 desde '89 (motor TU), r.o. 97523016</p>	
 <p><b>3011</b> boquilla alojamiento termostato 1.1-1.4 TU r.o. 97523152</p>	 <p><b>3019</b> tubo de agua metálico Diesel hasta '89 r.o. 1213.29</p>	 <p><b>3134</b> tubo de agua metálico Diesel desde '89 hasta '91, r.o. 1213.31</p>
 <p><b>3057</b> tubo de agua metálico Diesel desde '91 r.o. 1307.W2</p>	 <p><b>3059</b> boquilla en culata Diesel r.o. 93010296</p>	 <p><b>3081</b> boquilla en tapa termostato 1.1-1.4 TU r.o. 96064657</p>
 <p><b>3082</b> boquilla en tapa termostato Diesel y TU r.o. 96064659</p>	  <p><b>3171</b> boquilla en caja termostato Diesel r.o. 1336.N7</p>	  <p><b>3637</b> válvula desvaporizadora Diesel XUD9 r.o. 0361.58</p>
 <p><b>3503</b> con junta tórica brida plástico conexión manguitos 1.7 Diesel r.o. 1336.G4+1340.28</p>	 <p><b>3544</b> brida plástico conexión manguitos 1.7 Diesel r.o. 1336.P0</p>	 <p><b>3578</b> tapa bomba de agua motor TU con junta tórica, r.o. 1201.66</p>
 <p><b>3611</b> tapa con termostato motor TU desde '99 r.o. 1336.Q2</p>	 <p><b>3616</b> tapa de termostato Diesel r.o. 1336.E8</p>	 <p><b>3631</b> decantador completo con tapón, motor Diesel, r.o.</p>
 <p><b>3595</b> botella de expansión 1.7D y 1.9D desde '94 r.o. 95593183</p>	 <p><b>3548</b> tapón botella de expansión r.o. 1306.84</p>	 <p><b>3608</b> tapón radiador (metálico) 1,20 bar r.o. 1306.85</p>

SUSPENSION DELANTERA Y SOPORTES DE MOTOR:

C-15 1124 y 1360 cc hasta '89 (motor plano)

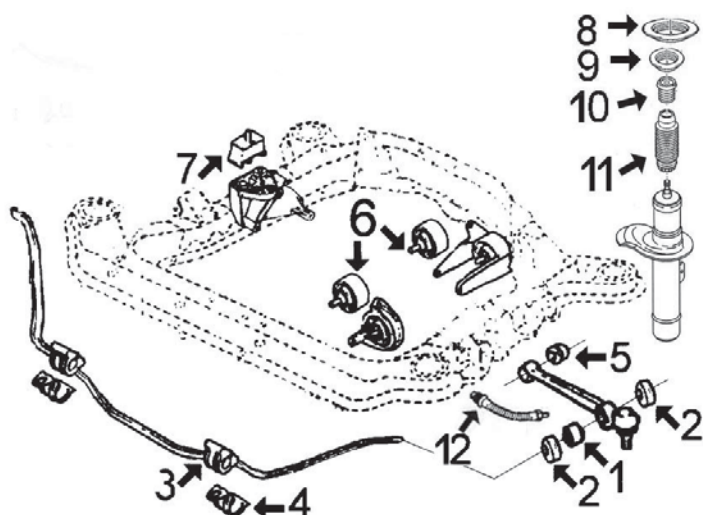

- 1- n/d silentbloc central brazo delantero
- 2- 875 aislador elástico silentbloc central brazo (de poliuretano)
- 3- n/d soporte de goma barra estabilizadora
- 4- n/d abrazadera soporte barra estabilizadora
- 5- 454 silentbloc extremo brazo de suspensión
- 6- n/d silentbloc para soportes de motor izquierdo
- 7- 831 soporte de motor derecho
- 8- 4406 soporte goma amortiguador con rodamiento
- 9- 4181 rodamiento soporte amortiguador
- 10- 2972 tope goma altura 57 mm  
2975 tope poliuretano altura 79 mm
- 11- 2933 capuchón amortiguador
- 12- 96009 latiguillo freno delantero (352 mm)

C-15 todas desde '89:

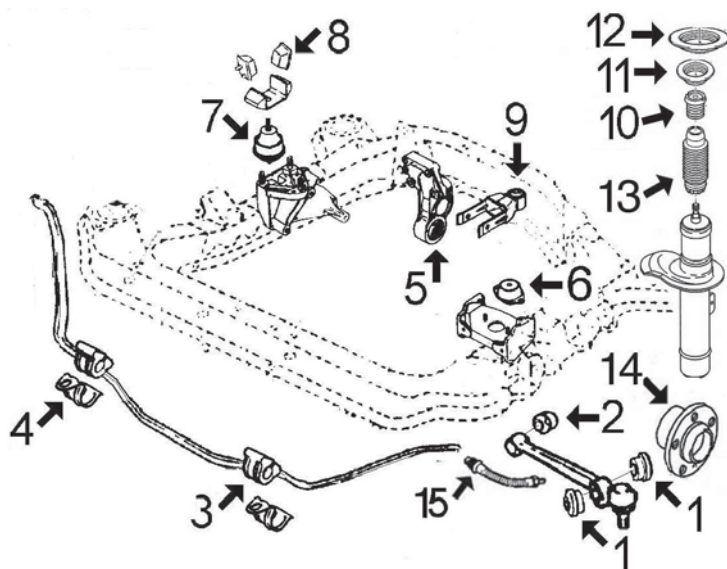

- 1- 685 silentbloc central brazo delantero
- 2- 454 silentbloc extremo brazo delantero
- 3- 687 goma barra estabilizadora Ø 20 mm transparente  
688 goma barra estabilizadora Ø 22 mm verde  
2488 goma barra estabilizadora Ø 23 mm azul  
2915 goma barra estabilizadora Ø 24 mm blanca
- 4- 901 abrazadera de barra estabilizadora
- 5- 751 silentbloc del soporte de motor trasero Ø 65 mm motor TU  
694 silentbloc del soporte de motor trasero Ø 70 mm motor 1.7XUD hasta '92  
2869 silentbloc del soporte de motor trasero Ø 70 mm motor 1.7XUD desde '92  
2980 silentbloc del soporte de motor trasero Ø 70 mm motor 1.9DW8
- 6- 531 soporte de motor izquierdo
- 7- 697 soporte de motor derecho (hidráulico)
- 8- 905 limitador soporte de motor derecho
- 9- 4743 tirante posterior motor completo motor TU  
4744 tirante posterior motor completo 1.7D y 1.9D  
877 silentbloc en tirante posterior motor
- 10- 2972 tope goma altura 57 mm  
2975 tope poliuretano altura 79 mm
- 11- 4181 rodamiento soporte amortiguador
- 12- 4406 juego soporte amortiguador con rodamiento
- 13- 2933 capuchón amortiguador
- 14- 90013 buje rueda delantera
- 15- 96009 latiguillo freno delantero racor hexagonal (352 mm)  
96046 latiguillo freno delantero racor de estriás (355 mm)

SUSPENSION TRASERA:

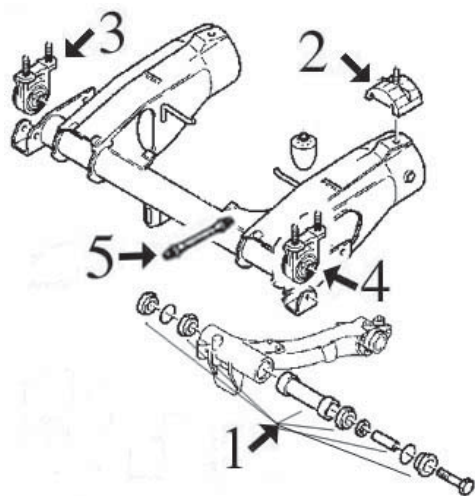

- 1- 2684 juego reparación articulación brazo trasero completo (11 piezas)
- 2- 4943 soporte brazo trasero suspensión
- 3- 2909 soporte derecho puente trasero
- 4- 2910 soporte izquierdo puente trasero
- 5- 96010 latiguillo freno trasero (210 mm)



**875** poliuretano  
aislador silentbloc central, gasolina hasta '89  
r.o.91503310



**454**  
silentbloc extremo brazo de suspensión  
r.o.96096727 (10x28x28x34)



**685**  
silentbloc central brazo delantero desde '89  
r.o.91515653 - 3523.35 (12x36x25, ala47)



**901**  
abrazadera barra estabilizadora desde '89  
r.o.95632726



**687** Ø 20 mm - transparente  
goma barra estabilizadora desde '89  
r.o.91516382 - 5094.36



**688** Ø 22 mm - verde  
goma barra estabilizadora desde '89  
r.o.91539592 - 5094.37



**2488** Ø 23 mm - azul  
goma barra estabilizadora desde '89  
r.o.5094.40



**2915** Ø 24 mm - blanca  
goma barra estabilizadora desde '89  
(+ de 750 Kg.) r.o.91539592



**751** Ø 65 mm  
silentbloc de soporte de motor trasero  
1.1 - 1.4 motor TU (desde '89)



**694** Ø 70 mm  
silentbloc soporte de motor trasero 1.7D  
r.o.



**2869**  
silentbloc soporte de motor trasero 1.7D  
desde '92, r.o.1809.16

## CITROËN C-15



**2980**

silentbloc soporte de motor trasero 1.7D desde '92 y 1.9DW8, r.o. 1809.21

**¡NUEVO!**



**4743**

tirante posterior motor completo motores TU r.o.

**¡NUEVO!**



**4744**

tirante posterior motor completo 1.7D-1.9D r.o. 1854.16



**697**

**HIDRAULICO (650 g.)**

soporte de motor derecho Diesel todas y gasolina desde '89, r.o. 1844.42 - 1844.38



**697/1**

**no hidráulico (460 g.)**

soporte de motor derecho Diesel todas y gasolina desde '89, r.o.



**831**

soporte de motor dcho. gasolina hasta '89 r.o. 91521643



**531**

soporte de motor izquierdo Diesel todas y gasolina desde '89, r.o. 91521643



**2909**

soporte derecho puente trasero r.o. 95632593



**2910**

soporte izquierdo puente trasero r.o. 95632592

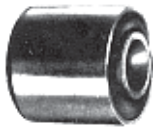

**877**

silentbloc de tirante trasero de motor r.o. 1809.04(12x30x28x34)



**905**

limitador soporte de motor derecho r.o. 91535412 - 1844.17



**4406**

soporte amortiguador con rodamiento r.o. 5031.25 - 5031.92



**2972**

**altura 57 mm**

tope goma suspensión delantera r.o. 5033.23



**2975**

**altura 79 mm**

tope poliuretano suspensión delantera r.o. 5033.26



**2933**

capuchón amortiguador delantero r.o. 5254.13



**4181**

rodamiento superior amortiguador delantero r.o. 5035.27



**2684**

juego reparación brazo suspensión trasero completo con rodamientos

**¡NUEVO!**



**4943**

soporte brazo trasero suspensión r.o. 5149.90



**90013**

buje rueda delantera desde '89 r.o. 3307.49



**96009**

latiguillo freno delantero, racor hexagonal (352mm), r.o. 91515816



**96046**

latiguillo freno delantero, racor de estrías (355mm), r.o. 4806.55



# CITROËN C-15



**96010**

latiguillo freno trasero (210 mm)  
r.o. 4816.26

## ARTICULACIONES PALANCA DE CAMBIO DIESEL:

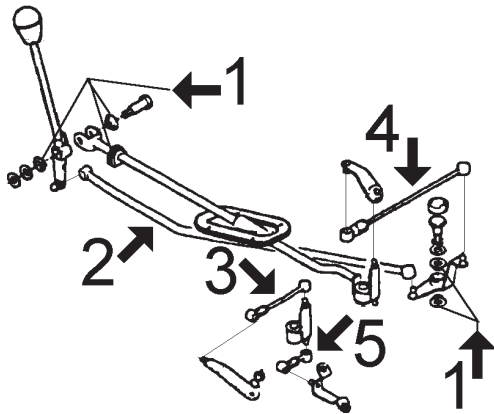

- 1- 2409 juego casquillos palanca de cambio y selector
- 2- 2323 barra paso de velocidades (largo 698 mm)
- 3- 2347 bieleta de selección (largo 135 mm)
- 4- 2348 bieleta de selección (largo 300 mm)
- 5- 2407 bieleta de selección (largo 56 mm)

rótulas de Ø 13 mm



**2323**

barra paso de velocidades Diesel  
(largo 698 mm), r.o. 96035210

long. máx: 135 mm  
long. mín: 90 mm  
rótulas de Ø 10 mm



**2347**

bieleta de selección velocidades Diesel  
r.o. 96006362-2454.74

long. máx: 300 mm  
long. mín: 265 mm  
rótulas de Ø 13 mm



**2348**

bieleta de selección velocidades Diesel  
r.o. 2444.82

rótulas de Ø 10 mm  
long. máx. 67 mm  
long. mín. 52 mm



**2407**

bieleta de selección velocidades Diesel  
(largo 56 mm), r.o. 95589889



**2409**

juego casquillos palanca de cambio y selector,  
r.o. 7910005487-95589866-95589882



**2400**

casquillo eje palanca de cambio C-15 E  
desde '89 (motor TU), r.o. 95634960

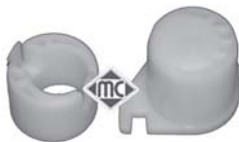

**4043**

juego casquillos horquilla embrague Diesel  
r.o. 2175.20+2175.21



**4052**

horquilla embrague completa Diesel  
(con casquillos), r.o. 2115.25

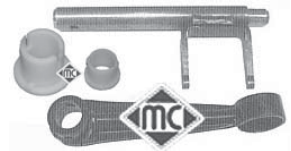

**4300**

horquilla embrague completa motor TU  
(con casquillos), r.o. 2117.52

**¡Nuevo!**



**4424**

casquillo guía embrague 1.1-1.4 TU  
r.o. 2105.14

**¡Nuevo!**



**4605**

casquillo guía embrague 1.7D-1.9D  
r.o. 2105.35



















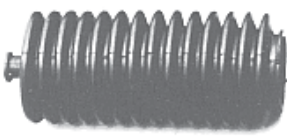

**¡Nuevo!**



**4564**

Ø 30/47 y 40/58 mm  
juego retenes diferencial-transmisión  
r.o. 3121.44+3121.46

## CITROËN C-15

<p><b>¡Nuevo!</b></p>  <p><b>3639</b> tapón aceite motor 1.1-1.4 TU r.o. 0258.55</p>	<p><b>¡Nuevo!</b></p>  <p><b>3642</b> tapón aceite motor 1.9 Diesel-DW8 r.o. 1180.F9</p>	 <p><b>2335</b> varilla nivel aceite motor TU gasolina r.o. 1174.10-1174.49</p>
<p><b>¡Nuevo!</b></p>  <p><b>4597</b> varilla nivel aceite motor 1.9 Diesel-DW8 r.o.</p>	<p><b>¡Nuevo!</b></p>  <p><b>4612</b> varilla nivel aceite motor 1.7 Diesel desde '94 r.o.</p>	<p><b>¡Nuevo!</b></p>  <p><b>3651</b> tapa filtro gasoil 1.9 Diesel-DW8 con brida r.o. 1904.27+1904.26</p>
 <p><b>2848</b>      Ø 142 mm - 5 canales polea cigueñal 1.7 Diesel (compatible con 4 canales) r.o. 0515.K9</p>	<p><b>¡Nuevo!</b></p>  <p><b>2927</b> polea cigueñal 1.9 Diesel-DW8 hasta 11/'03 r.o. 0515.Q6</p>	<p><b>¡Nuevo!</b></p>  <p><b>4610</b> polea cigueñal 1.9 Diesel-DW8 desde 11/'03 r.o. 0515.R5</p>
 <p><b>942</b> funda protectora Delco r.o. 5966.16</p>	<p><b>1268 kit</b>      <b>268 fuelle</b> fuelle cremallera dirección r.o. 91510293</p> 	<p><b>287</b> juego casquillos cremallera r.o.</p> 
 <p><b>4392</b> cruceta dirección (superior) r.o. 95496536</p>	<p><b>4396</b>      <b>360 mm</b> cruceta dirección (inferior) hasta '92 r.o. 95496537</p> 	<p><b>4397</b>      <b>345 mm</b> cruceta dirección (inferior) desde '92 r.o. 96081921</p> 
<p><b>1488E</b> kit rep. transm./rda para montar en cono gasolina hasta '89, r.o. 95532950</p> 	<p><b>1493E</b> kit rep. transm./rda para montar en cono l/rda Diesel hasta '92, r.o. 96009166</p> 	<p><b>1493</b> kit rep. transm. l/rda Diesel hasta '92 r.o. 96009166</p> 
<p><b>1556</b> kit rep. transm. l/cambio gasolina hasta '89 (cárter de 78 mm Ø 70), r.o. 95565567</p> 	<p><b>1533</b> kit rep. transm. l/cambio gasolina desde '90 (cárter de 87 mm Ø 70), r.o. 95619709</p> 	<p><b>1362</b> kit rep. transm. l/cambio Diesel hasta '92 r.o. 95590794</p> 

## CITROËN C-15



**1761E**

kit rep transm. l/rda. **para montar en cono**  
(interior una garganta), r.o. 9403293778



**1273E**

kit rep transm l/rda **para montar en cono**  
(interior doble garganta), r.o. 3293.74



**1273**

kit rep. transm. l/rda gasolina desde '89  
(interior doble garganta), r.o. 3293.74



**1710E**

kit rep. transm. l/rda para montar en cono  
en neopreno especial de elasticidad 800%



**1710**

kit rep. transm. l/rda Diesel desde '92  
hasta '95, r.o. 3293.77



**1521**

kit rep. transmisión l/rueda desde '95 has-  
ta '04, r.o. 3293.05



**1839**

kit rep. transmisión l/cambio desde '95  
r.o. 3287.79



**1427**

kit rep. transm. l/rda todos desde '04  
r.o. 3293.20



**1428**

kit rep. transm. l/cbo. todos desde '04  
r.o.

**¡Nuevo!**



**3697**

juego tapas correa distribución 1.1-1.4  
motores TU1-TU3, r.o. 0320.S2+0320.L3

**¡Nuevo!**



**3698**

juego tapas correa distribución 1.7D desde  
2/'94-, r.o. 0320.H2+0320.H3+0320.F9

**¡Nuevo!**



**3700**

juego tapas correa distribución 1.9D desde  
'99- (DW8), r.o. 0320.N3/X6/N4

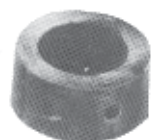

**092**

soporte tubo de escape Ø 30x41  
r.o. 5484441



**366**

soporte silenciador trasero  
r.o. 5481691



**2394**

Ø 58.2 mm  
junta cónica tubo de escape 1.1-1.4 gas.  
hasta '89, r.o. 91537799



**2393**

Ø 46.2 mm  
junta cónica tubo de escape Diesel todas y  
gasolina desde '89, r.o. 95602682

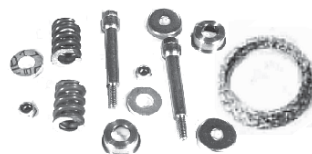

**2390**

Ø 58.2 mm  
kit montaje tubo de escape 1.1-1.4 gasolina  
hasta '89, r.o.



**2392**

Ø 46.2 mm  
kit montaje tubo de escape Diesel todas y  
gasolina desde '89, r.o.



**748**

collarín tubo de escape  
r.o. 95483762



**2025**

arandela tapón cárter motor TU Ø 16 mm  
r.o. 79532428



**667**

tapón cárter de aceite 16x150  
r.o. 7830197000

## CITROËN C-15



**2452**

tapón cárter de aceite 14x125 1.7D desde '94  
r.o.0311.21



**2929**

tapón cárter de aceite 10x125 (1.9DW8)  
r.o.0311.29



**2050**

arandela metaloplástica 14 x 22  
r.o.0313.27



**2051**

arandela plana 10 x 21 para tapón MC-2929  
r.o.0313.33



**4036**

bomba de cebado gasoil c/ válvula antirretorno y boquilla adicional a 90°, r.o. 1579.73



**2770**

cubrepedal freno  
r.o.4504.12



**2771**

cubrepedal embrague  
r.o.2130.13



**2772**

cubrepedal acelerador  
r.o.1604.07



**2728**

tapón de goma ciego Ø 12 mm  
r.o.



**2325**

tapón de goma ciego Ø 16 mm  
r.o.

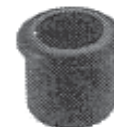

**2326**

tapón goma ciego Ø 20 mm  
r.o.



## CITROËN C25



**7350**  
mgto superior radiador  
r.o. 95572894- 1343.58



**7351**  
mgto inferior radiador  
r.o. 95572893- 1350.75



**709**  
goma puntal tensor brazo delantero  
r.o. 3561.08

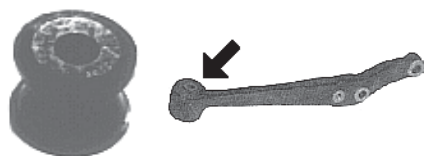

**2863**  
silentbloc brazo delantero suspensión  
r.o. no hay despiece



**1579**  
kit rep. transmisión l/rueda  
r.o. 95569342-3293.97



**1580**  
kit rep. transmisión l/cambio  
r.o.



**1820**  
fuelle cremallera asistida  
r.o. 4066.35



**1620**  
fuelle derecho cremallera manual  
r.o. 975000380 - 4066.19



**1621**  
fuelle izquierdo cremallera manual  
r.o. 975000280 - 4066.18



**2439**  
casquillo cremallera manual  
r.o.



**713**  
soporte de motor derecho  
r.o. 1843.94



**714**  
soporte motor izquierdo  
r.o. 1843.93



**650**  
soporte cambio hasta '91  
r.o. 1843.61



**837**  
soporte cambio desde '91  
r.o. 1843.98



**2470**  
cubrepedal freno y embrague  
r.o.



**366**  
soporte tubo de escape (Ø 32x59)  
r.o. 1755.38 - 1755.60



**667**  
tapón cárter de aceite 16x150  
r.o.

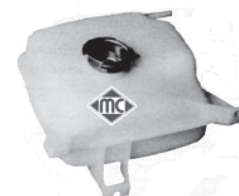

**3526**  
botella de expansión  
r.o. 1303.78



**90031**  
bujie rueda delantera desde '90 (cuello para retén de Ø 69 mm), r.o.



**96144**  
latiguillo freno delantero  
r.o. 4806.35-4806.36



**96095**  
latiguillo freno trasero  
r.o. 4816.27

## CANALIZACIONES DE AGUA:

**motores PSA 1.9 D (XUD9) y 1.9 TD (XUD9TE):**

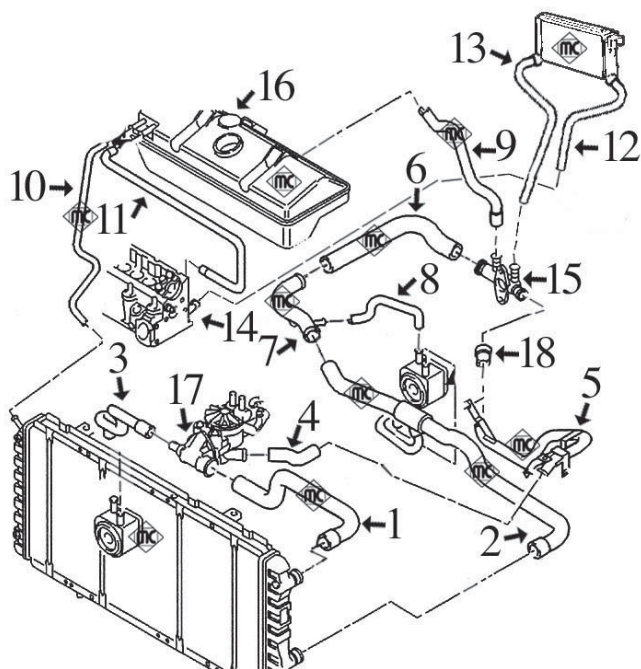

- 1- 8500 mgto superior radiador
- 2- 8502 mgto inferior radiador
- 3- 8506 mgto de tapa termostato a intercambiador
- 4- 8183 mgto de caja termostato a tubo hasta '98
- 8480 mgto de caja termostato a tubo desde '98
- 5- 3057 tubo de agua metálico
- 6- 8505 mgto de tubo metálico a racor plástico
- 7- 3131 tubo de agua metálico
- 8- 8501 mgto de intercambiador a tubo metálico
- 9- 8507 mgto de racor plástico a botella
- 10- 116 mgto de botella a radiador. Cortar de rollo MC-116  
Ø 8 x 15 mm longitud 720 mm
- 11- 8504 mgto de botella a culata
- 12- 8537 mgto de calefactor a culata
- 13- 8538 mgto de calefactor a racor plástico
- 14- 3059 boquilla en culata
- 15- 3503 racor plástico conexión mgts.
- 16- 3572 tapón botella expansión 1.0 bar
- 17- 3546 tapa de termostato
- 18- 8312 mgto de tubo metálico a racor plástico

**motores PSA 2.0HDi (DW10TD) y 2.2HDi (DW12TED):**

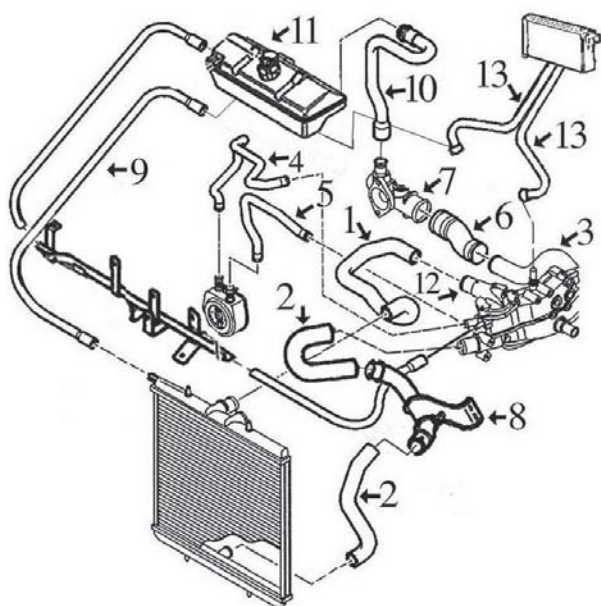

- 1- 8897 mgto superior radiador
  - 2- 8898 mgto inferior radiador (2 tramos)
  - 3- 3139 tubo de agua metálico 2.0HDi
  - 3174 tubo de agua metálico 2.2HDi
  - 4- 8554 mgto de intercambiador a caja termostato
  - 5- 8586 mgto de intercambiador a caja termostato
  - 6- 8587 mgto de tubo metálico a tapa bomba 2.0HDi
  - 8950 mgto de tubo metálico a tapa bomba 2.2HDi
  - 7- 3554 tapa bomba de agua conexión manguitos
  - 8- 3169 tubo de agua metálico empalme mgto inferior
  - 9- n/d mgto de botella a radiador
  - 10- n/d mgto de botella a tapa bomba
  - 11- 3572 tapón botella expansión
  - 12- 3135 tapa de termostato
  - 13- 8946 juego mgts de calefacción
- 8540 mgto desvaporizador

**motores SOFIM 2.5 D (DJ5) y 2.5 TurboD (DJ5T) hasta '97:**

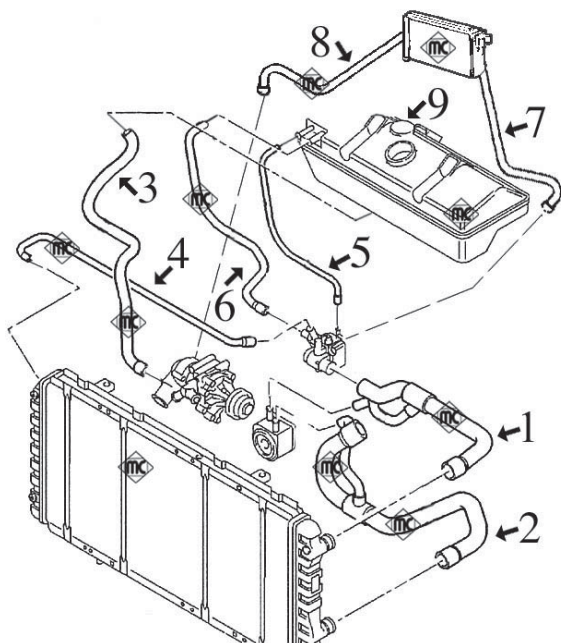

- 1- 8495 mgto superior radiador
- 2- 8496 mgto inferior radiador 2.5 Diesel  
8498 mgto inferior radiador 2.5 TurboD
- 3- 8497 mgto de bomba agua a botella
- 4- 8499 mgto de caja termostato a radiador
- 5- 116 mgto de botella a caja termostato. Cortar de rollo MC-116 Ø 8 x 15 mm longitud 950 mm
- 6- 8503 mgto de botella a caja termostato
- 7- 8508 mgto de calefactor a caja termostato
- 8- 8509 mgto de calefactor a bomba de agua
- 9- 3572 tapón botella expansión 1.0 bar

**motores SOFIM 2.5 TurboD (DJ5T) desde '97:**

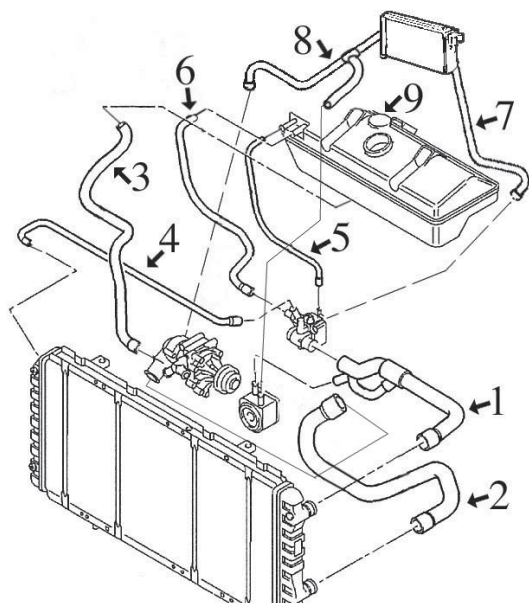

- 1- 8495 mgto superior radiador
- 2- 8901 mgto inferior radiador
- 3- 8497 mgto de bomba agua a botella
- 4- 8499 mgto de caja termostato a radiador
- 5- 116 mgto de botella a caja termostato. Cortar de rollo MC-116 Ø 8 x 15 mm longitud 950 mm
- 6- 8503 mgto de botella a caja termostato
- 7- 8932 mgto de calefactor a caja termostato
- 8- 8929 mgto de calefactor a bomba agua e intercambiador
- 9- 3572 tapón botella expansión 1.0 bar

motores SOFIM 2.8 - 2.8TD y 2.8HDi:

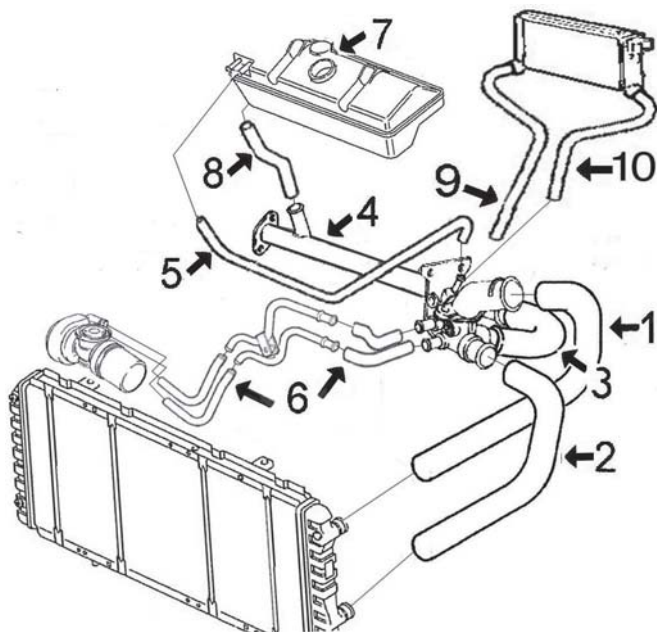

- 1- 8842 mgto superior radiador
- 2- 8843 mgto inferior radiador
- 3- 8832 mgto de caja termostato a tubo metálico
- 4- 3124 tubo de agua metálico
- 5- 117 mgto de caja termostato a botella: cortar de rollo MC-117 Ø 10x17 mm long. 420 mm
- 6- 8835 juego 4 mgtos de caja termostato a tubos metálicos y de tubos a intercambiador
- 7- 3572 tapón botella de expansión
- 8- 843 mgto de tubo metálico a botella: cortar de rollo MC-843 Ø 19x25 mm long. 420 mm
- 9- 8840 mgto de calefactor a culata
- 10- 8841 mgto de calefactor a caja termostato



**mgtos. DESVAPORIZADORES 1.9 Diesel (XUD9) y TurboD (XUD9TE)**  
(motores PSA)

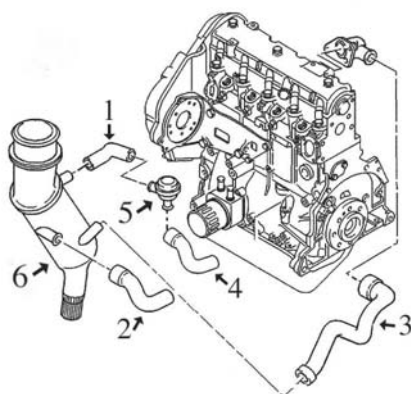

- 1- 8167 mgto de decantador a regulador motor 1.9 Diesel
- 8492 mgto de decantador a regulador motor 1.9 TurboD
- 2- 8166 mgto de cárter a decantador motores D+TD
- 3- 8494 mgto de decantador a culata D+TD
- 4- 8493 mgto de regulador a filtro aire TD
- 5- 3637 válvula desvaporizadora
- 6- 3666 decantador completo con tapón y junta tórica



## CITROËN JUMPER



**8183**

mgto de caja termostato a tubo 1.9D h/'98  
r.o. 1307.W3



**8312**

mgto de tubo metálico a racor plástico  
r.o. 1307.W4



**8480**

mgto de caja termostato a tubo desde '98  
r.o.



**8495**

mgto superior radiador 2.5 D-TD  
r.o.



**8496**

mgto inferior radiador 2.5 D  
r.o.



**8497**

mgto de botella a bomba agua  
r.o.



**8498**

mgto inferior radiador 2.5 TurboD  
r.o.



**8499**

mgto de caja termostato a radiador  
r.o.



**8500**

mgto superior radiador 1.9 D-TD  
r.o.



**8501**

mgto de intercambiador a tubo metálico 1.9  
r.o.



**8502**

mgto inferior radiador 1.9 D-TD  
r.o.



**8503**

mgto de botella a caja termostato 2.5  
r.o.



**8504**

mgto de botella a culata 1.9 D-TD  
r.o.



**8505**

mgto de tubo metálico a racor plástico 1.9  
r.o.



**8506**

mgto de caja termostato a intercambiador  
r.o.



**8507**

mgto de racor plástico a botella 1.9  
r.o.



**8508**

mgto de calefactor a caja termostato 2.5  
r.o.



**8509**

mgto de calefactor a bomba agua 2.5  
r.o.



**8537**

mgto de calefactor a culata 1.9  
r.o.



**8538**















mgto de calefactor a racor plástico 1.9  
r.o.



**8554**

mgto de intercambiador 2.0-2.2HDi  
r.o.

## CITROËN JUMPER

 <p><b>8586</b> mgto de intercambiador 2.0-2.2HDi r.o.</p>	 <p><b>8587</b> mgto de tubo a tapa de plàstico 2.0HDi r.o.</p>	 <p><b>8832</b> mgto de caja termostato a tubo 2.8HDi r.o.</p>
 <p><b>8835</b> jgo mgto intercambiador a caja 2.8HDi r.o.</p>	 <p><b>8840</b> mgto de calefactor a culata 2.8HDi r.o.</p>	 <p><b>8841</b> mgto de calefactor a caja termost. 2.8HDi r.o.</p>
 <p><b>8842</b> mgto superior radiador 2.8HDi r.o.</p>	 <p><b>8843</b> mgto inferior radiador 2.8HDi r.o.</p>	
 <p><b>8897</b> mgto sup radiador 2.0-2.2HDi r.o.</p>	 <p><b>8898</b> mgto inferior radiador 2.0-2.2HDi (2 tramos) r.o.</p>	 <p><b>8901</b> mgto inferior radiador 2.5 TD desde '97 r.o.</p>
 <p><b>8932</b> mgto calefactor a caja termostato 2.5TD r.o.</p>	 <p><b>8929</b> mgto de calefactor a bomba 2.5TD desde '97 r.o.</p>	 <p><b>8946</b> jgo mgto calefactor 2.0-2.2HDi r.o.</p>
 <p><b>8950</b> mgto de tubo a tapa de plàstico 2.2HDi r.o.</p>		

## CITROËN JUMPER

 <p><b>8166</b> mgto desvaporizador 1.9 D y TD r.o. 1192.48</p>	 <p><b>8167</b> mgto desvaporizador 1.9 D r.o. 1180.A3</p>	 <p><b>8492</b> mgto desvaporizador 1.9 TD r.o.</p>
 <p><b>8493</b> mgto desvaporizador 1.9 D y TD r.o.</p>	 <p><b>8494</b> mgto desvaporizador 1.9 TD r.o.</p>	 <p><b>8540</b> mgto desvaporizador 2.0HDi-2.2HDi r.o.</p>
 <p><b>3057</b> tubo de agua metálico 1.9 D-TD r.o. 1307.W2</p>	 <p><b>3059</b> boquilla en culata 1.9 D-TD r.o. 0245.42-0245.44</p>	 <p><b>3124</b> tubo de agua metálico 2.8HDi r.o.</p>
 <p><b>3131</b> tubo de agua metálico 1.9 D-TD r.o.</p>	 <p><b>3135</b> tapa de termostato 2.0-2.2HDi r.o. 1336.P2</p>	 <p><b>3139</b> tubo de agua metálico 2.0HDi r.o. 1307.YZ</p>
 <p><b>3169</b> tubo de empalme mgto inferior 2.0-2.2HDi r.o. 1307.XX</p>	 <p><b>3174</b> tubo de agua metálico 2.2HDi con junta r.o. 1307.SJ</p>	 <p><b>3503</b> racor plástico conexión mgto 1.9 D-TD r.o. 1336.G4</p>
 <p><b>3523</b> racor plástico conexión mgto 2.0 gasolina r.o. 1336.H7</p>	 <p><b>3546</b> tapa de termostato 1.9 D - TD r.o. 1336.G3</p>	 <p><b>3554</b> racor plástico conexión mgto 2.0-2.2HDi r.o. 1336.P5</p>
 <p><b>3572</b> tapón botella expansión 1.0 bar r.o. 1306.E1</p>	 <p><b>3637</b> válvula desvaporizadora 1.9D XUD9 r.o. 0361.58</p>	 <p><b>3666</b> decantador completo con tapón y junta 1.9D(XUD9),r.o. 1180.C0+1170.17</p>

## CITROËN JUMPER

### SUSPENSION DELANTERA y SOPORTES DE MOTOR HASTA -2001 (X23F):

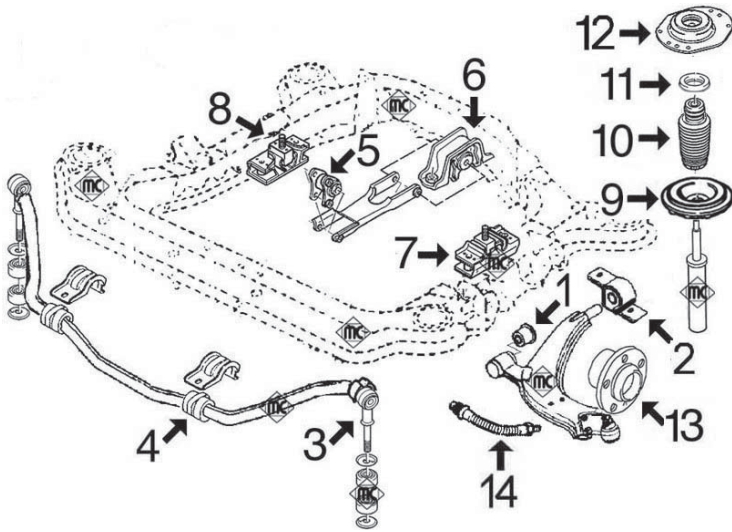

- 1- 2872 silentbloc anterior trapecio delantero
- 2- 2873 silentbloc posterior trapecio delantero
- 3- 2956 bieleta puntal barra estabilizadora completa
- 4- n/d goma barra estabilizadora
- 5- 2985 silentbloc tirante posterior motor
- 6- 2984 soporte motor trasero
- 7- 2987 soporte motor izquierdo 2.0-1.9D-2.5D-2.8D  
4565 soporte motor izquierdo 2.0HDi-2.2HDi-2.8HDi
- 8- 2986 soporte motor derecho 2.0-1.9D-2.5D-2.8D  
4565 soporte motor derecho 2.0HDi-2.2HDi-2.8HDi
- 9- 4446 soporte superior muelle delantero
- 10- 4616 capuchón con tope amortiguador 1.000/1.400 Kg.  
4617 capuchón con tope amortiguador 1.800 Kg.
- 11- 4182 rodamiento soporte amortiguador delantero
- 12- 2918 soporte amortiguador izquierdo  
2925 soporte amortiguador derecho
- 13- 90039 buje de rueda delantera 1.000-1.400 Kg.  
90040 buje de rueda delantera 1.800 Kg.
- 14- 96102 latiguillo freno delantero (490 mm)

### SUSPENSION DELANTERA y SOPORTES DE MOTOR DESDE 2001- (U5F):

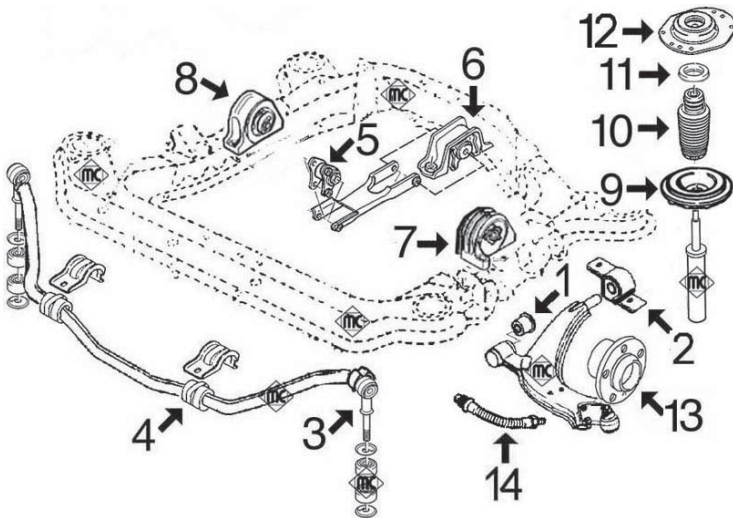

- 1- 2872 silentbloc anterior trapecio delantero
- 2- 2873 silentbloc posterior trapecio delantero
- 3- 2956 bieleta puntal barra estabilizadora completa
- 4- n/d goma barra estabilizadora
- 5- 2985 silentbloc tirante posterior motor
- 6- 2984 soporte motor trasero
- 7- 4566 soporte motor izquierdo
- 8- 4567 soporte motor derecho
- 9- 4446 soporte superior muelle delantero
- 10- 4616 capuchón con tope amortiguador 1.000/1.400 Kg.  
4617 capuchón con tope amortiguador 1.800 Kg.
- 11- 4182 rodamiento soporte amortiguador delantero
- 12- 4570 soporte amortiguador izquierdo  
4571 soporte amortiguador derecho
- 13- 90039 buje de rueda delantera 1.000-1.400 Kg.  
90040 buje de rueda delantera 1.800 Kg.
- 14- 96102 latiguillo freno delantero (490 mm)

### SUSPENSION TRASERA:

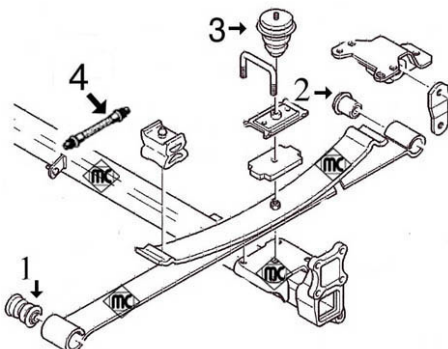

- 1- 2954 silentbloc anterior ballesta
- 2- 2955 silentbloc posterior ballesta
- 3- 2957 tope poliuretano
- 4- 96145 latiguillo freno trasero (360 mm)



## CITROËN JUMPER



**2872**  
silentbloc anterior trapecio delantero  
r.o.



**2873**  
silentbloc posterior trapecio delantero  
r.o.



**2918**  
soporte amortiguador izquierdo  
r.o.5038.18-5038.41



**2925**  
soporte amortiguador derecho  
r.o.5038.19-5038.42



**2954**  
silentbloc anterior ballesta trasera  
r.o.5131.73



**2955**  
silentbloc posterior ballesta trasera  
r.o.5131.72

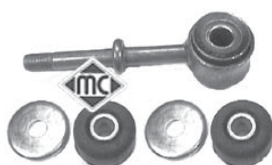

**2956**  
bieleta puntal barra estabilizadora completa  
r.o.5087.37+5093.15



**2957**  
tope poliuretano suspensión posterior  
r.o.



**2984**  
soporte motor trasero  
r.o.1846.66



**2985**  
silentbloc tirante posterior motor  
r.o.1846.65



**2986**  
soporte motor derecho  
r.o.1844.46



**2987**  
soporte motor izquierdo  
r.o.1827.17-1827.18



**4182**  
rodamiento soporte suspensión  
r.o.5035.47

**¡Nuevo!**



**4446**  
soporte superior muelle suspensión delant.  
r.o.5031.40-5031.75

**¡Nuevo!**



**4565**  
soporte motor 2.0-2.0HDi-2.8HDi hasta '01  
r.o.1807.R5-1801.39-1839.A0-1802.53

**¡Nuevo!**

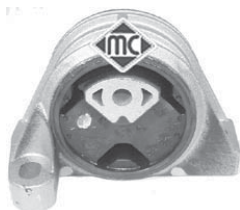

**4566**  
soporte motor izqdo. todos tipos desde '01  
r.o.1801.T1-1807.S9-1807.S7

**¡Nuevo!**



**4567**  
soporte motor dcho. todos tipos desde '01  
r.o.1839.A6-1802.56-1839.AT

**¡Nuevo!**

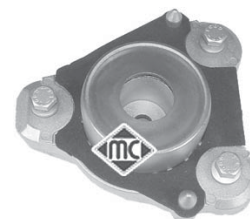

**4570**  
soporte dcho. amortiguador delt. desde '01  
r.o.5038.87-5038.72-

**¡Nuevo!**



**4571**  
soporte izqdo. amortiguador delt. desde '01  
r.o.5038.89-5038.E3

**¡Nuevo!**



**4616**  
capuchón con tope amortg. delt. 1.000-1.400  
kgs, r.o.5033.41

**¡Nuevo!**



**4617**  
capuchón con tope amortg. delt. 1.800 kgs.  
r.o.5033.42

## CITROËN JUMPER

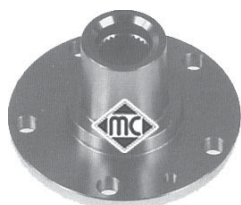

**90039**

buje de rueda delantera 1.000-1.400 Kgs.  
r.o. 3307.65



**90040**

buje de rueda delantera 1.800 Kgs.  
r.o. 3307.66



**96102**

latiguillo freno delantero (490 mm)  
r.o.



**96145**

latiguillo freno trasero (360 mm)  
r.o.

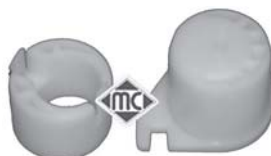

**4043**

juego casquillos horquilla embrg. 1.9D-TD  
r.o. 2175.20+2175.21



**4052**

horquilla embrague completa  
2.0XU y 1.9Diesel y TD, r.o. 2115.25

**¡Nuevo!**



**4601**

horquilla embrague 2.0 HDi  
r.o. 2117.66-2117.57

**¡Nuevo!**



**4554**

pedal embrague completo con muelle retorno  
r.o. 2127.A4+2148.31



**2926**

polea cigüeñal 1.9 D-TD hasta '97  
r.o. 0515.G3



**4202**

polea cigüeñal 1.9 D-TD desde '97  
r.o. 0515.K4

**¡Nuevo!**



**4201**

polea cigüeñal 2.5 D-TD  
r.o. 0515.H3



**2928**

Ø162 mm 6 canales  
polea cigüeñal 2.0 HDi (hasta 5/'04)-2.2 HDi  
sin aire ac., r.o. 0515.P2

**¡Nuevo!**



**4798**

Ø158 mm 6 canales  
polea cigüeñal 2.0 HDi (desde 5/'04)-2.2 HDi  
con aire ac., r.o. 0515.S8

**¡Nuevo!**



**4568**

polea cigüeñal 2.8D-TD-2.8 HDi  
r.o. 0515.P3-0515.P9-0515.N2



**4197**

cardán dirección cremallera manual  
r.o. 4103.E6



**1820**

fuelle cremallera dirección  
r.o. 4006.22



**1225**

kit rep. transmisión l/rda. 1.000-1400 Kg.  
r.o. 3293.98



**2307**

kit rep. transmisión l/rda. 1.800 Kg.  
hasta '96, r.o. 3293.99



**1391**

kit rep. transmisión l/rda. 1.800 Kg. desde  
'96, r.o. 3293.07



**1362**

kit rep. transmisión l/cbo. "1.000 Kg."  
r.o. 3287.90



**1407**

kit rep. transmisión l/cbo. "1.800 Kg."  
r.o. 3287.78

## CITROËN JUMPER

<p><b>¡Nuevo!</b></p>  <p><b>3698</b> juego tapas correa distribución 1.9XUD r.o. 0320.H2/H3/F9</p>	<p><b>¡Nuevo!</b></p>  <p><b>3699</b> juego tapas correa distribución 2.0HDI r.o. 0320.N5/N6/S7</p>	<p><b>¡Nuevo!</b></p>  <p><b>4807</b> tensor correa alternador 2.0HDI sin a/c r.o. 5751.30</p>
<p><b>¡Nuevo!</b></p>  <p><b>5043</b> tensor correa alternador 2.0/2.2HDI desde '04 r.o. 5751.74</p>	<p><b>¡Nuevo!</b></p>  <p><b>4620</b>      <math>\text{Ø } 32/50 \text{ y } 40/58 \text{ mm}</math> juego retenes diferencial-transmisión r.o. 3121.24+3121.44</p>	<p><b>¡Nuevo!</b></p>  <p><b>3642</b> tapón llenado aceite 2.0HDI-2.2HDI r.o. 1180.F9</p>
<p><b>¡Nuevo!</b></p>  <p><b>4995</b> rodillo tensor correa alternador 2.0HDI r.o. 5751.29</p>	<p><b>¡Nuevo!</b></p>  <p><b>4915</b>      <math>\text{Ø } 54,60 \text{ mm}</math> polea de alternador de rueda libre r.o.</p>	<p><b>¡Nuevo!</b></p>  <p><b>4916</b>      <math>\text{Ø } 58,50 \text{ mm}</math> polea de alternador de rueda libre r.o.</p>
<p><b>¡Nuevo!</b></p>  <p><b>4479</b> soporte tapa motor HDI r.o. 0137.11</p>	<p><b>2392</b>      <b>junta de <math>\text{Ø } 60 \times 46 \text{ mm}</math></b> kit montaje colector escape 1.9 Diesel r.o. 1798.76</p> 	<p><b>2940</b>      <b>junta de <math>\text{Ø } 80 \times 66 \text{ mm}</math></b> kit montaje colector escape 1.9 TD y 2.5 r.o.</p> 
<p><b>¡Nuevo!</b></p>  <p><b>4598</b>      <b>junta de <math>\text{Ø } 80 \times 66 \text{ mm}</math></b> kit montaje colector escape 2.0HDI-2.2HDI- 2.8HDI-Sofim 2.5TD, r.o.</p>	<p><b>¡Nuevo!</b></p>  <p><b>4599</b>      <b>junta de <math>\text{Ø } 60 \times 46 \text{ mm}</math></b> kit montaje colector escape Sofim 2.5D- 2.8TD, r.o.</p>	<p><b>366</b> soporte tubo de escape (32x59 mm) r.o. 1755.60</p> 
<p><b>4010</b> soporte tubo escape 2.0HDI-2.2HDI r.o. 1755.68</p> 	<p><b>2638</b> soporte tubo de escape r.o. 1755.65</p> 	<p><b>2452</b> tapón cárter aceite 14 x 125 r.o. 0311.21</p> 
<p><b>667</b> tapón cárter aceite 16 x 150 r.o. 0163.88</p> 		



## CANALIZACIONES DE AGUA:

**mgtos. motor 1.9 D (XUD) y 1.9 TD (XUDTE) (hasta '99)**

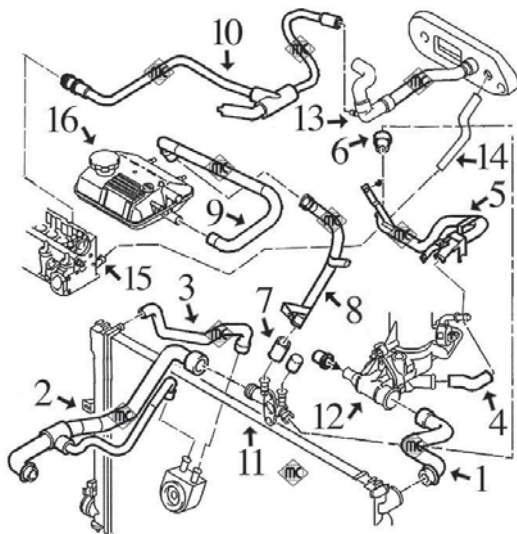

- 1- 8484 mgto superior radiador
- 2- 8483 mgto inferior radiador
- 3- 8489 mgto de radiador a intercambiador
- 4- 8183 mgto de caja termostato a tubo hasta '98  
8480 mgto de caja termostato a tubo desde '98
- 5- 3057 tubo de agua metálico
- 6- 8312 mgto de tubo metálico a racor plástico
- 7- 8488 mgto de racor plástico a tubo metálico
- 8- 3130 tubo metálico de racor plástico a botella
- 9- 8487 mgto de tubo metálico a botella
- 10- 8490 mgto de tubo de calefacción a culata, TurboDiesel
- 11- 3503 racor plástico conexión mgtos.
- 12- 3546 tapa de termostato  
3171 boquilla metálica en caja de termostato
- 13- 8485 mgto dcho. calefactor
- 14- 8486 mgto izqdo. calefactor
- 15- 3059 boquilla en culata
- 16- 3741 botella de expansión  
3547 tapón botella expansión 1.0 bar

**mgtos. motor 1.9DW8 (desde '99)**

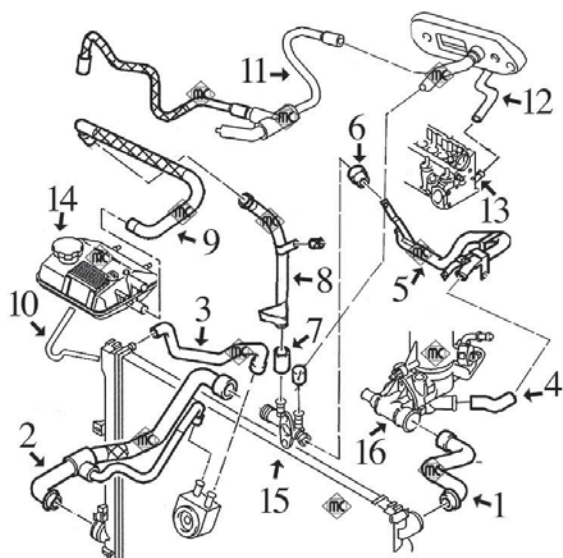

- 1- 8564 mgto superior radiador
- 2- 8557 mgto inferior radiador
- 3- 8556 mgto de radiador a intercambiador hasta '00  
8558 mgto de radiador a intercambiador desde '00
- 4- 8480 mgto de caja termostato a tubo
- 5- 3129 tubo de agua metálico
- 6- 8312 mgto de tubo metálico a racor plástico
- 7- 8488 mgto de racor plástico a tubo metálico hasta '00
- 8- 3138 tubo metálico de racor plástico a botella hasta '00
- 9- 8561 mgto de tubo metálico a botella hasta '00  
8562 mgto de tubo metálico a botella desde '00
- 10- 8563 mgto de botella a radiador
- 11- 8559 mgto de calefactor a botella
- 12- 8560 mgto de calefactor a culata
- 13- 3059 boquilla en culata
- 14- 3741 botella de expansión hasta 6/'00  
3742 botella de expansión desde 6/'00  
3547 tapón botella expansión 1.0 bar
- 15- 3544 racor plástico conexión manguitos
- 16- 3539 tapa de termostato  
3171 boquilla metálica en caja de termostato

**mgtos. motor 2.0 HDi**

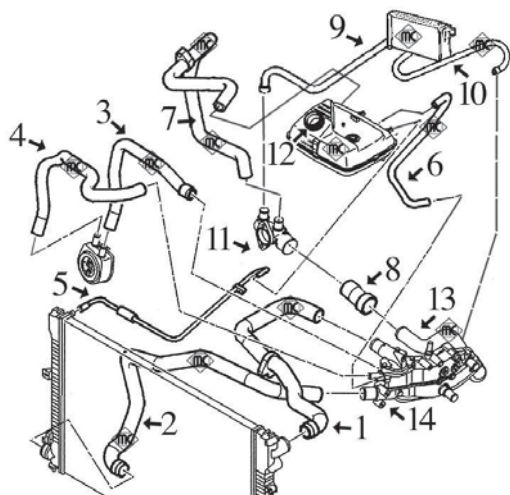

- 1- 8598 mgto superior radiador
- 2- 8597 mgto inferior radiador
- 3- 8585 mgto de intercambiador a caja termostato
- 4- 8596 mgto de intercambiador a caja termostato
- 5- 8592 mgto de botella a radiador
- 6- 8591 mgto de botella a caja termostato
- 7- 8595 mgto de racor plástico a botella
- 8- 8587 mgto de tubo metálico a racor plástico
- 9- 8593 mgto derecho calefactor
- 10- 8594 mgto izquierdo calefactor
- 11- 3554 racor plástico conexión manguitos
- 12- 3742 botella de expansión  
3547 tapón botella expansión 1.0 bar
- 13- 3139 tubo metálico con junta tórica
- 14- 3135 tapa de termostato (aluminio)  
3556 tapa de termostato (plástico)



## CITROËN JUMPY - EVASION



**8183**  
mgto de caja termostato a tubo 1.9D h/'98  
r.o. 1307.W3



**8312**  
mgto de tubo metálico a racor plástico  
r.o. 1307.W4



**8480**  
mgto de caja termostato a tubo  
r.o.



**8483**  
mgto inferior radiador 1.9 D  
r.o.



**8484**  
mgto superior radiador 1.9 D  
r.o.



**8485**  
mgto derecho calefactor 1.9 D  
r.o.



**8486**  
mgto izquierdo calefactor 1.9 D  
r.o.



**8487**  
mgto de tubo metálico a botella  
r.o.



**8488**  
mgto de racor plástico a tubo metálico  
r.o.



**8489**  
mgto de radiador a intercambiador  
r.o.



**8490**  
mgto de tubo calefacción a culata 1.9 TD  
r.o.



**8556**  
mgto de radiador a intercambiador  
r.o.



**8557**  
mgto inferior radiador 1.9 DW8  
r.o.



**8558**  
mgto de radiador a intercambiador  
r.o.



**8559**  
mgto de calefactor a botella  
r.o.



**8560**  
mgto de calefactor a culata  
r.o.



**8561**  
mgto de tubo metálico a botella  
r.o.



**8562**  
mgto de tubo metálico a botella  
r.o.



**8563**  
mgto de botella a radiador  
r.o.



**8564**  
mgto superior radiador 1.9 DW8  
r.o.



**8585**  
mgto de intercambiador 2.0 HDi  
r.o.

## CITROËN JUMPY - EVASION



**8587**  
mgto de tubo metálico a racor plástico HDi  
r.o.



**8591**  
mgto de botella a caja termostato HDi  
r.o.



**8592**  
mgto de botella a radiador HDi  
r.o.



**8593**  
mgto derecho calefactor HDi  
r.o.



**8594**  
mgto izquierdo calefactor HDi  
r.o.



**8595**  
mgto de botella a racor plástico  
r.o.



**8596**  
mgto de intercambiador a caja termostato  
r.o.



**8597**  
mgto inferior radiador 2.0 HDi  
r.o.



**8598**  
mgto superior radiador 2.0 HDi  
r.o.



**3057**  
tubo de agua metálico 1.9 D y TD  
r.o. 1307.W2



**3059**  
boquilla en culata 1.9 Diesel todos  
r.o. 0245.42-0245.44



**3078**  
boquilla en caja termostato 1.8 gasolina  
r.o. 1336.K8



**3129**  
tubo de agua metálico 1.9 DW8  
r.o. 1307.NY



**3130**  
tubo de agua metálico a botella 1.9 D  
r.o. 1307.AY



**3135**  
tapa de termostato 2.0 HDi (aluminio)  
r.o. 1336.P2



**3138**  
tubo de agua metálico 1.9 DW8  
r.o. 1307.PH



**3139**  
tubo de agua metálico 2.0 HDi con junta  
r.o. 1307.YZ



**3171**  
boquilla en caja termostato 1.9D-TD (XU)  
r.o. 1336.N7



**3503**  
racor conexión mgto 1.9 Diesel hasta '99  
r.o. 1336.G4

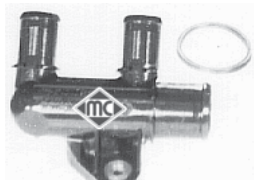

**3523**  
racor conexión mgto 1.8 gasolina  
r.o. 1336.H7



**3538**  
tapa de termostato 1.8 gasolina (XU7)  
r.o. 1336.A1

## CITROËN JUMPY - EVASION



**3539**  
tapa de termostato 1.9 DW8  
r.o. 1336.C9



**3544**  
racor conexión mgts 1.9 Diesel DW8  
r.o. 1336.P0-1336.Q3



**3546**  
tapa de termostato 1.9 Diesel  
r.o. 1336.G3



**3547**  
tapón botella expansión 1.0 bar  
r.o. 1336.E0-1336.C6



**3554**  
racor conexión mgts 2.0 HDi  
r.o.



**3556**  
tapa de termostato 2.0 HDi (plástico)  
r.o. 1336.R9

**¡nuevo!**



**3741**  
botella de expansión 1.6-1.8 gasolina y 1.9D  
hasta 6/00, r.o. 1307.RH-1307.RJ

**¡nuevo!**



**3742**  
botella de expansión 1.9D desde 6/00, 2.0  
gasolina y 2.0 HDi, r.o. 1307.ST

## mgtos. DESVAPORIZADORES 1.9 Diesel-XUD9 y XUD9TE:

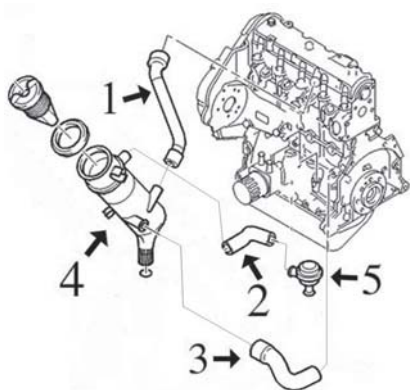

- 1- 8307 mgto de tapa balancines a decantador motores XUD
- 2- 8167 mgto de decantador a válvula motor 1.9D-XUD
- 3- 8166 mgto de bloque a decantador motor 1.9D-XUD9
- 8491 mgto de bloque a decantador motor 1.9TD-XUD9TE
- 4- 3631 decantador completo con tapón 1.9D-XUD
- 5- 3637 válvula desvaporizadora 1.9D-XUD

## mgtos. DESVAPORIZADORES 1.9 Diesel DW8:

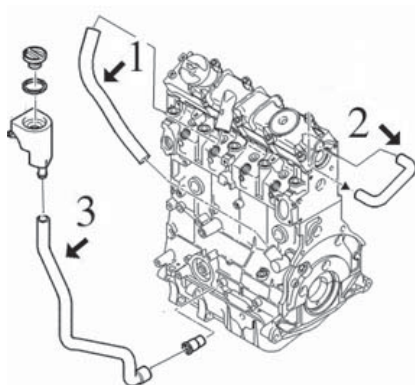

- 1- 8474 mgto de tapa balancines a colector motor 1.9 DW8
- 2- 8475 mgto de bloque a culata motor 1.9 DW8
- 3- n/d mgto de cárter a regulador



**8166**  
mgto desvaporizador 1.9 D y TD  
r.o. 1192.48



**8167**  
mgto desvaporizador 1.9 D y TD  
r.o. 1180.A3



**8307**  
mgto desvaporizador 1.9 D y TD  
r.o. 1180.86



**8474**  
mgto desvaporizador 1.9DW8  
r.o. 1180.G4



**8475**  
mgto desvaporizador 1.9DW8  
r.o. 1180.G5



**8491**  
mgto desvaporizador 1.9 TD (XUDTE)  
r.o.



**3631**  
decantador completo con tapón  
r.o. 1180.95



**3637**  
válvula desvaporizadora 1.9D-TD  
(motores XUD), r.o. 0361.58



**4490**  
soporte decantador motor 1.8 XU7  
r.o. 1439.10



**SUSPENSION DELANTERA y SOPORTES DE MOTOR**  
**MOTORES DE GASOLINA 1.6 (FIAT 1580 SPi) - 1.8 (PSA-XU7) y 2.0 (PSA-EW10)**

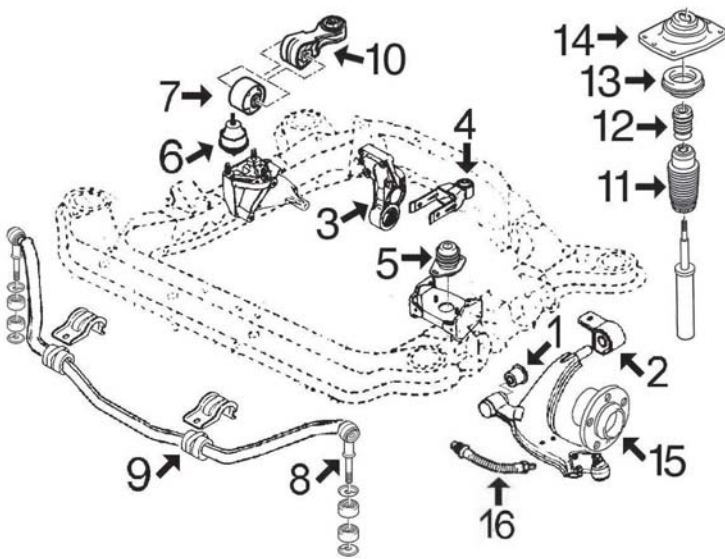

- 1- 2981 silentbloc anterior trapecio delantero
- 2- 2982 silentbloc posterior trapecio delantero izquierdo
- 2983 silentbloc posterior trapecio delantero derecho
- 3- 2869 silentbloc soporte posterior motor 1.6-1.8
- 2966 silentbloc soporte posterior motor 2.0
- 4- 4744 tirante trasero de motor completo
- 877 silentbloc en tirante posterior de motor
- 5- 2794 soporte izquierdo motor, cambio manual
- 2943 soporte izquierdo motor, cambio automático
- 6- 2924 soporte derecho motor 1.6-1.8
- 2942 soporte derecho motor 2.0
- 7- 2869 silentbloc soporte bieleta antipar
- 8- 2948 bieleta puntal barra estabilizadora completa
- 9- 2945 goma soporte barra estabilizadora
- 10- 4744 bieleta antipar 1.8 (XU7)
- 4486 bieleta antipar 2.0 (EW10)
- n/d bieleta antipar 1.6
- 11- 4196 capuchón amortiguador delantero
- 12- n/d tope poliuretano
- 13- 4206 rodamiento
- 14- 2947 soporte amortiguador izquierdo, dirección asistida
- soporte amortiguador derecho, dirección manual
- 2946 soporte amortiguador derecho, dirección asistida
- soporte amortiguador izquierdo, dirección manual
- 15- 90038 buje rueda delantera
- 16- 96032 latiguillo freno delantero (515 mm)

**SUSPENSION DELANTERA y SOPORTES DE MOTOR**  
**MOTORES DIESEL 1.9 D (XUD y DW8) y 2.0 HDi (DW10)**

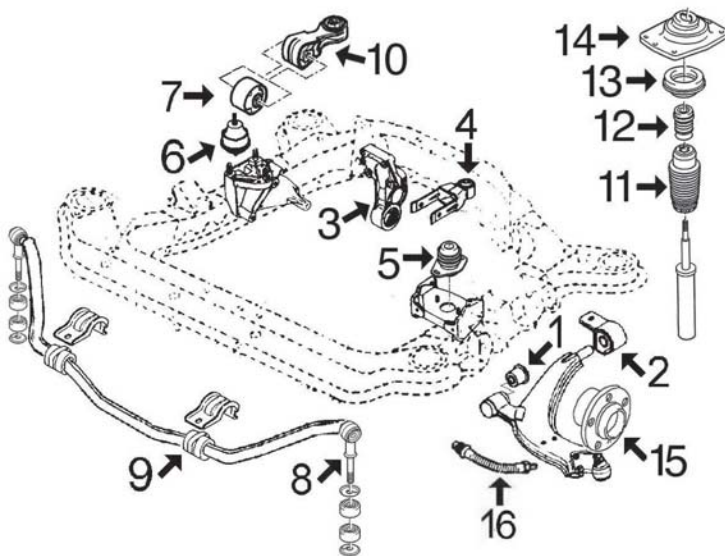

- 1- 2981 silentbloc anterior trapecio delantero
- 2- 2982 silentbloc posterior trapecio delantero izquierdo
- 2983 silentbloc posterior trapecio delantero derecho
- 3- 2980 silentbloc soporte posterior motor 1.9 Diesel-XUD,
- 1.9 Diesel-DW8
- 2966 silentbloc soporte posterior motor 2.0 HDi
- 4- 4744 tirante trasero de motor completo
- 877 silentbloc en tirante posterior de motor
- 5- 2794 soporte izquierdo motor 1.9 Diesel XUD y DW8
- 2943 soporte izquierdo motor 2.0 HDi
- 6- 2924 soporte derecho motor 1.9 Diesel-XUD
- 2942 soporte derecho motor 1.9 Diesel-DW8
- 2944 soporte derecho motor 2.0 HDi
- 7- 2869 silentbloc soporte bieleta antipar hasta 6/'01
- (desde 6/'01 incorporado en bieleta MC-4005)
- 8- 2948 bieleta puntal barra estabilizadora completa
- 9- 2945 goma soporte barra estabilizadora
- 10- 4744 bieleta antipar 1.9D-TD-DW8 y 2.0 HDi hasta 6/'01
- 4005 bieleta antipar 1.9DW8 y 2.0 HDi desde 6/'01
- 11- 4196 capuchón amortiguador delantero
- 12- n/d tope poliuretano
- 13- 4206 rodamiento
- 14- 2947 soporte amortiguador izquierdo, dirección asistida
- soporte amortiguador derecho, dirección manual
- 2946 soporte amortiguador derecho, dirección asistida
- soporte amortiguador izquierdo, dirección manual
- 15- 90038 buje rueda delantera
- 16- 96032 latiguillo freno delantero (515 mm)

# CITROËN JUMPY - EVASION

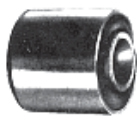

**877**  
silentbloc tirante posterior motor  
r.o.1809.04(12x30x28x34)

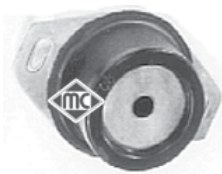

**2794**  
soporte izquierdo motor  
r.o.1844.36-1827.10

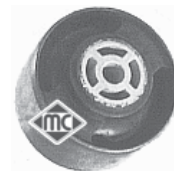

**2869**  
silentbloc soporte trasero motor  
r.o.1809.16



**2924**  
soporte motor derecho 1.6-1.8 y 1.9D  
r.o.1827.14-1827.26



**2942**  
soporte motor derecho 2.0 gasolina y 1.9DW  
r.o.1844.92



**2943**  
soporte motor izquierdo 2.0 HDi y automat.  
r.o.1827.16



**2944**  
soporte motor derecho 2.0 HDi  
r.o.1827.33



**2945**  
goma barra estabilizadora  
r.o.5094.69



**2946**  
soporte amortiguador Dcho-Izqdo.  
r.o.5038.17



**2947**  
soporte amortiguador Dcho-Izqdo.  
r.o.5038.16

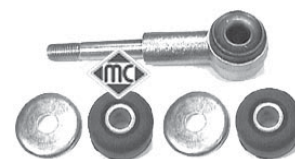

**2948**  
bieleta puntal barra estabilizadora completa  
r.o.5087.35



**2949**  
silentbloc **brazo trasero** de suspensión  
r.o.5152.61(12x46x48x60)



**2966**  
silentbloc soporte motor trasero 2.0 HDi  
r.o.1809.30



**2980**  
silentbloc soporte motor trasero 1.9 D  
r.o.1809.21



**2981**  
silentbloc anterior trapecio delantero  
r.o. no hay despiece



**2982**  
silentbloc posterior trapecio delt. izquierdo  
r.o. no hay despiece



**2983**  
silentbloc posterior trapecio delt. derecho  
r.o. no hay despiece



**4005**  
bieleta tirante derecho motor (antipar)  
r.o.1806.28

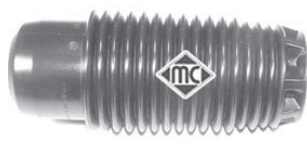











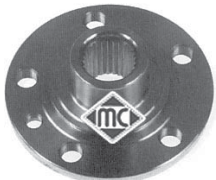



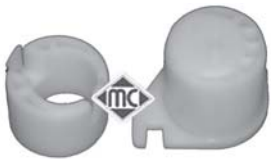



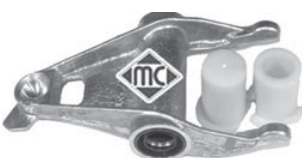

**4196**  
capuchón amortiguador delantero  
r.o.5254.19



**4206**  
rodamiento en soporte amortiguador  
r.o.5035.43

## CITROËN JUMPY - EVASION

<p><b>¡Nuevo!</b></p>  <p><b>4486</b> bieleta tirante de reacción motor 1.8-2.0 gasolina, r.o. 1806.34</p>	<p><b>¡Nuevo!</b></p>  <p><b>4744</b> bieleta tirante reacción y tirante trasero completo, r.o.</p>	 <p><b>90038</b> buje rueda delantera r.o. 3307.64</p>
 <p><b>96032</b> latiguillo freno delantero (515 mm) r.o. 4806.82</p>	 <p><b>96167</b> latiguillo freno trasero (275 mm) r.o. 4806.67</p>	 <p><b>4036</b> bomba cebado manual gasoil r.o.</p>
 <p><b>4159</b> bieleta mando cambio, rótulas de Ø 13 mm (extensible de 75 a 105 mm) r.o.</p>	 <p><b>4043</b> juego casquillos horquilla embrague motores XU y DW, r.o. 2175.20 - 2175.21</p>	 <p><b>4052</b> horquilla embrag. completa con casquillos motores XU y 1.9DW8, r.o. 2115.25</p>
<p><b>¡Nuevo!</b></p>  <p><b>4605</b> casquillo guía embrague con retén r.o. 2105.35</p>	 <p><b>4066</b> horquilla embrague motor 1.9DW8 y 2.0HDi r.o. 2117.58</p>	<p><b>¡Nuevo!</b></p>  <p><b>4799</b> horquilla embrague motor 2.1TD y 2.0HDi completa con casquillos, r.o. 2117.59</p>
<p><b>¡Nuevo!</b></p>  <p><b>4562</b> polea cigueñal 2.0 gasolina-EW10 d/'01 r.o. 0515.R1</p>	<p><b>¡Nuevo!</b></p>  <p><b>4485</b> polea cigueñal 1.8 gasolina (XU7) r.o. 0515.H6</p>	<p><b>¡Nuevo!</b></p>  <p><b>4443</b> polea cigueñal 2.0 gasolina-EW10 hasta '01 r.o. 0515.N3</p>
 <p><b>2926</b> polea cigueñal 1.9 D (XUD, hasta '98) r.o. 0515.G3</p>	 <p><b>2927</b> polea cigueñal 1.9 DW8 sin aire acond. r.o. 0515.Q6</p>	 <p><b>2928</b> polea cigueñal 1.9DW8-2.0HDi hasta 10/'04 r.o. 0515.P2</p>
<p><b>¡Nuevo!</b></p>  <p><b>4477</b> polea cigueñal 1.9DW8-2.0HDi desde 10/'04 r.o. 0515.S4</p>	<p><b>¡Nuevo!</b></p>  <p><b>4738</b> polea cigueñal 2.0HDi/16v r.o. 0515.R9</p>	<p><b>¡Nuevo!</b></p>  <p><b>4479</b> soporte tapa cubre motor 2.0HDi r.o. 0137.11-0137.23</p>



## CITROËN JUMPY - EVASION

<p><b>¡Nuevo!</b></p>  <p><b>3642</b> tapón llenado aceite 1.9DW8-2.0HDi r.o. 1180.F9</p>	<p><b>¡Nuevo!</b></p>  <p><b>4612</b> varilla nivel aceite 1.9D-TD (XUD) r.o. 1174.15</p>	 <p><b>1370</b> fuelle cremallera dirección dcho. e izqd. r.o. 4066.41</p>
 <p><b>1996</b> kit rep. transmisión l/rda 1.6 - 1.8 (cambio BE3)r.o. 3293.01</p>	 <p><b>1520</b> kit rep. transmisión l/rda 1.6 - 1.8 (cambio BE3R)r.o. 3293.96</p>	 <p><b>1222</b> kit rep. transmisión l/rda 1.9 Diesel r.o. 3293.02</p>
 <p><b>1217</b> kit rep. transmisión l/rda Turbo D r.o. 3293.00</p>	 <p><b>1499</b> kit rep. transmisión l/rda 2.0 HDi r.o. 3293.06</p>	 <p><b>1362</b> kit rep. transmisión l/cbo. todos salvo 1.9D r.o. 3287.79</p>
 <p><b>1213</b> kit rep. transmisión l/cbo. 1.9 Diesel r.o. 3287.81</p>	<p><b>¡Nuevo!</b></p>  <p><b>4564</b>      Ø 30/47 y 40/58 mm juego retenes diferencial-transmisión (cambio BE3-BE4), r.o. 3121.44+3121.46</p>	<p><b>¡Nuevo!</b></p>  <p><b>4620</b>      Ø 32/50 y 40/58 mm juego retenes diferencial-transmisión (cambio ME-ML5T), r.o. 3121.44+3121.24</p>
<p><b>¡Nuevo!</b></p>  <p><b>3651</b> tapa filtro gasoil 1.9 DW8 con junta y clip de cierre, r.o. 1904.27+1904.26</p>	 <p><b>2931</b> tensor correa alternador completo 1.9D r.o. 5751.81</p>	<p><b>¡Nuevo!</b></p>  <p><b>3698</b> juego tapas correa distribución 1.9D -'99 (XUD), r.o. 0320.H2/H3/F9</p>
<p><b>¡Nuevo!</b></p>  <p><b>3700</b> juego tapas correa distribución 1.9D '99- (DW8), r.o. 0320.N3/X6/N4</p>	<p><b>¡Nuevo!</b></p>  <p><b>3699</b> juego tapas correa distribución 2.0HDi (DW10), r.o. 0320.N5/N6/S7</p>	<p><b>¡Nuevo!</b></p>  <p><b>5043</b> tensor correa alternador 1.9 DW8 sin A/C r.o. 5751.74</p>
<p><b>¡Nuevo!</b></p>  <p><b>4609</b> tensor correa alternador 1.9 D r.o. 5751.38</p>	<p><b>¡Nuevo!</b></p>  <p><b>4826</b> tensor correa alternador 1.9 D-TD-DW8 r.o. 5751.30</p>	<p><b>¡Nuevo!</b></p>  <p><b>4807</b> tensor correa alternador 2.0HDi r.o. 5751.55</p>



## CITROËN JUMPY - EVASION

<p><b>4929</b> rodillo tensor correa alternador 1.8 con A/C r.o.5751.20</p>	<p><b>4895</b> tensor correa alternador 1.8 con A/C r.o.5751.35</p>	<p><b>4995</b> rodillo tensor correa alternador 1.9DW8-2.0HDI con A/C, r.o. 5751.29</p>
<p><b>4996</b> rodillo tensor correa alternador 2.0HDI sin A/C, r.o.5751.96-5751.57</p>	<p><b>4928</b> rodillo tensor correa alternador 1.9DW8 sin A/C, r.o. 5751.73</p>	<p><b>4915</b>                      <b>Ø 54,60 mm</b> polea de alternador de rueda libre r.o.</p>
<p><b>4916</b>                      <b>Ø 58,50 mm</b> polea de alternador de rueda libre r.o.</p>	<p><b>2938</b>                      <b>junta de Ø 58 x 45 mm</b> kit montaje colector escape 1.9 D (DW8) r.o.1797.12</p>	<p><b>2940</b>                      <b>junta de Ø 80 x 66 mm</b> kit montaje colector escape 1.6-1.8 gasolina r.o.1798.80-1798.75</p>
<p><b>2951</b>                      <b>junta de Ø 71 x 58 mm</b> kit montaje colector escape 1.9 TD (XUD9TE) r.o.1797.22-1798.79</p>	<p><b>2952</b>                      <b>junta de Ø 60 x 46 mm</b> kit montaje colector escape 1.9 D (XUD9) r.o. 1798.81</p>	<p><b>2950</b>                      <b>junta de Ø 78 x 66 mm</b> kit montaje colector escape 2.0 HDi r.o.1797.21</p>
<p><b>2753</b> soporte tubo de escape r.o.1755.69-1755.63</p>	<p><b>2754</b> soporte tubo de escape r.o.1755.62</p>	<p><b>2770</b> cubrepedal freno r.o.4504.12</p>
<p><b>2771</b> cubrepedal embrague r.o.2130.13</p>	<p><b>2772</b> cubrepedal acelerador r.o.1604.07</p>	<p><b>2452</b> tapón cárter de aceite 14 x 125 r.o.0311.21</p>
<p><b>2929</b> tapón cárter de aceite 10 x 125, 1.9 Diesel desde '99, r.o.0311.29</p>	<p><b>2050</b> arandela tapón de cárter metaloplástica (14x22), r.o.0313.27</p>	<p><b>2051</b> arandela tapón de cárter plana 10 x 21 mm r.o.0313.33</p>

## CANALIZACIONES DE AGUA:

SAXO, motores de gasolina 1.1-TU1, 1.3-TU3J, 1.6-TU5J

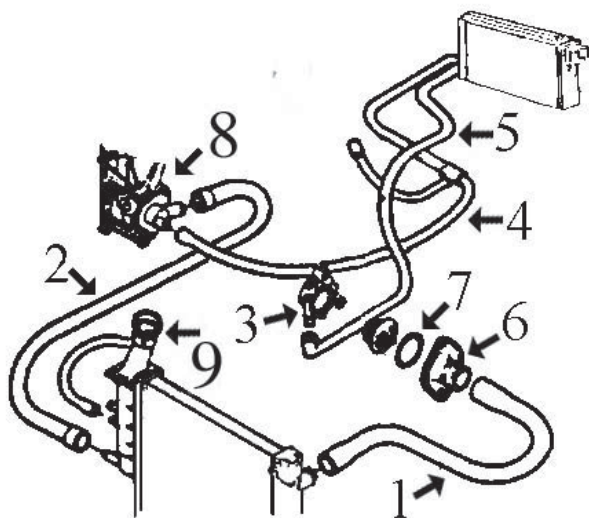

- 1- 8523 mgto superior radiador salvo 1.6 con aire ac.  
8524 mgto superior radiador 1.6 aire acondicionado
- 2- 8526 mgto inferior radiador sin aire acondicionado  
8527 mgto inferior radiador con aire acondicionado
- 3- 3081 boquilla metálica inferior en caja termost. h/'99  
3082 boquilla metálica superior en caja termost. h/'99
- 4- 8536 mgto de calefactor a bomba y colector
- 5- 8528 mgto de calefactor a caja termost. hasta '99  
8529 mgto de calefactor a caja termost. desde '99  
8534 mgto de calefactor a caja termost. automáticos
- 6- 3011 tapa de termostato hasta '99 (metálica)  
3611 tapa (plástico) con termostato desde '99
- 7- 2351 junta de termostato hasta '99
- 8- 3578 tapa bomba de agua 1.1-1.4 hasta 9/'00  
3641 tapa bomba de agua 1.1-1.4 desde 9/'00  
3640 tapa bomba de agua 1.6 desde 9/'00
- 9- 3548 tapón botella expansión 1.4 bar

SAXO motor 1.5 Diesel

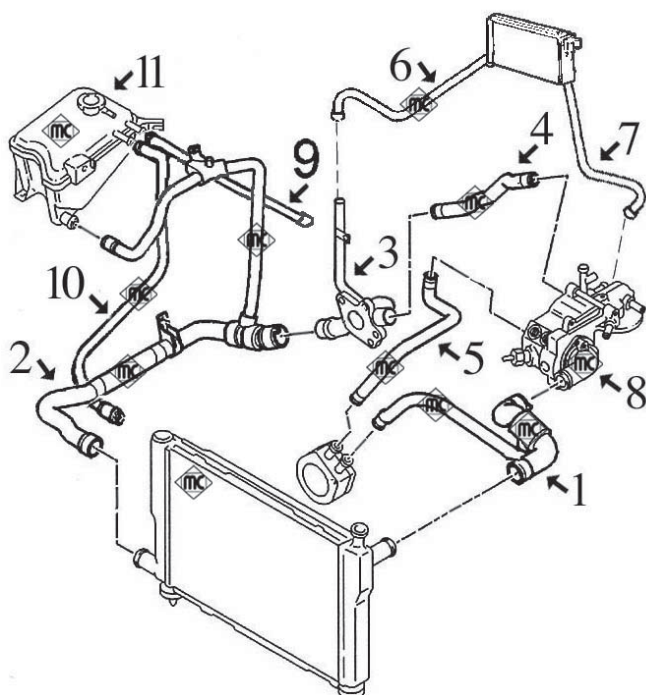

- 1- 8518 mgto superior radiador versiones con intercambiador en filtro de aceite  
8519 mgto superior radiador versiones sin intercambiador en filtro de aceite
- 2- 8516 mgto inferior radiador (juego completo 2 tramos)
- 3- 3133 tubo de agua metálico
- 4- 8511 mgto de tubo metálico a caja termostato
- 5- 8520 mgto de intercambiador a caja termostato
- 6- 8513 mgto de calefactor a tubo metálico
- 7- 8514 mgto de calefactor a caja termostato
- 8- 3550 tapa de termostato (plástico)  
3132 tapa de termostato (aluminio)
- 9- 8510 mgto de botella a caja termostato
- 10- 8517 mgto de botella a radiador
- 11- 3643 botella de expansión  
3548 tapón botella expansión 1.4 bar





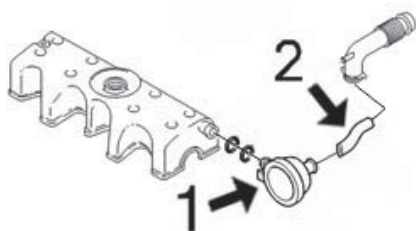











mgto desvaporizador: MC-8533

106 - 1.5 Diesel, desvaporizadores:



- 1- 3655 válvula desvaporizadora con juntas tóricas
- 2- 8533 mgto de válvula desvaporizadora a filtro aire

## CITROËN SAXO

 <p><b>8511</b> mgto de tubo metálico a caja termostato 1.5D r.o.</p>	 <p><b>8513</b> mgto de calefactor a tubo metálico 1.5 D r.o.</p>	 <p><b>8514</b> mgto de calefactor a caja termostato r.o.</p>
 <p><b>8516</b> mgto inferior radiador (juego completo) r.o.</p>	 <p><b>8517</b> mgto de botella a radiador 1.5 D r.o.</p>	 <p><b>8518</b> mgto superior radiador 1.5 D con intercambiador en filtro de aceite, r.o.</p>
 <p><b>8519</b> mgto superior radiador 1.5 D sin intercambiador en filtro de aceite, r.o.</p>	 <p><b>8520</b> mgto de intercambiador a caja termostato 1.5D, r.o.</p>	 <p><b>8523</b> mgto superior radiador 1.1-1.4-1.6 . r.o.</p>
 <p><b>8524</b> mgto superior radiador 1.6 aire acondicion. r.o.</p>	 <p><b>8526</b> mgto inferior radiador gasolina sin aire ac. r.o.</p>	 <p><b>8527</b> mgto inferior radiador gasolina c/ aire ac. r.o.</p>
 <p><b>8528</b> mgto de calefactor a caja termostato r.o.</p>	 <p><b>8529</b> mgto de calefactor a caja termostato r.o.</p>	 <p><b>8533</b> mgto desvaporizador 1.5 Diesel r.o.</p>
 <p><b>8534</b> mgto de calefactor a caja, automáticos r.o.</p>	 <p><b>8536</b> mgto de calefactor a bomba y colector r.o.</p>	

## CITROËN SAXO



**2351** Ø 41 x 47 mm  
junta de termostato 1.1-1.4-1.6 hasta '99  
r.o. 97523016



**3011**  
tapa de termostato hasta '99  
r.o. 1336.44



**3081** Ø 15,5 mm  
boquilla en caja termostato hasta '99  
r.o. 96064657



**3082** Ø 10 mm  
boquilla en caja termostato hasta '99  
r.o. 96064659



**3132**  
tapa de termostato (aluminio)  
r.o. 1336.C2



**3133**  
tubo de agua metálico 1.5 Diesel  
r.o. 1204.38



**3548**  
tapón de radiador / botella expans. 1.4 bar  
r.o. 1336.84-1336.C7



**3550**  
tapa de termostato 1.5 Diesel (plástico)  
r.o. 1336.L2-1336.K2



**3578**  
tapa bomba de agua 1.1-1.4 con junta tórica, r.o. 1201.66



**3611**  
tapa con termostato 1.1-1.4-1.6 desde '99  
r.o. 1336.Q2

**¡Nuevo!**



**3640**  
tapa bomba de agua 1.6 desde 9/'00  
r.o. 1201.C3

**¡Nuevo!**



**3641**  
tapa bomba de agua 1.1-1.4 con junta tórica, r.o. 1201.C2+1206.96

**¡Nuevo!**



**3655**  
válvula reguladora desvaporizador 1.5D  
r.o. 0361.C7



## SUSPENSION DELANTERA Y SOPORTES DE MOTOR:

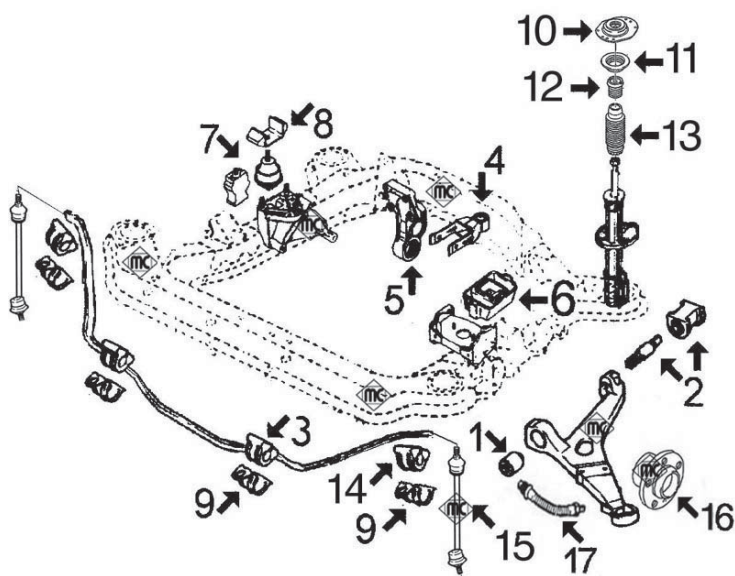

- 1- 2387 silentbloc anterior trapecio delantero salvo VTS  
2970 silentbloc anterior trapecio delantero VTS
- 2- 2386 silentbloc posterior trapecio delantero (juego completo con eje pasador)
- 3- 2989 goma para barra estabiliz. de Ø 18 mm  
2388 goma para barra estabiliz. de Ø 19 mm  
2389 goma para barra estabiliz. de Ø 21 mm  
2990 goma para barra estabiliz. de Ø 22 mm
- 4- 4746 tirante posterior motor completo 1.1-1.4-1.6TU  
4744 tirante posterior motor completo 1.5D  
877 silentbloc del tirante trasero de motor
- 5- 2666 soporte trasero de motor (completo)  
4064 silentbloc del soporte trasero motor
- 6- 531 soporte izquierdo motor 1.1-1.4-1.6  
2786 soporte izquierdo motor 1.5 Diesel y automáticos
- 7- 2784 soporte derecho de motor 0.9-1.1  
2959 soporte dcho. de motor 1.4-1.6 y 1.5D
- 8- 2960 limitador soporte derecho de motor
- 9- n/d abrazadera barra estabilizadora
- 10- 2967 soporte superior amortiguador delantero desde '94
- 11- 4181 rodamiento soporte suspensión
- 12- 2991 tope poliuretano suspensión
- 13- 2974 capuchón amortiguador
- 14- 2701 goma puntal barra estabiliz. de Ø 19 mm  
2702 goma puntal barra estabiliz. de Ø 21 mm
- 15- 2968 bieleta puntal barra estabilizadora 1.6-VTS
- 16- 90044 buje rueda delantera de 3 agujeros, 1.1 sin servo-dirección ni ABS  
90013 buje rueda delantera (4 agujeros) de 21 estrías (hasta '99)  
90045 buje rueda delantera (4 agujeros) de 25 estrías (desde '99)
- 17- 96046 latiguillo freno delantero (rueda de 3 agujeros) 355 mm  
96180 latiguillo freno delantero (rueda de 4 agujeros) 325 mm

## SUSPENSION TRASERA:

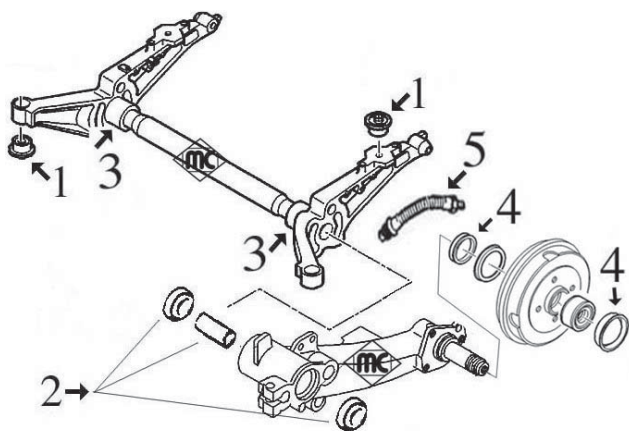

- 1- 2838 silentbloc soporte puente trasero
- 2- 4563 juego de rodamientos, retenes y casquillos brazo trasero
- 3- 4499 eje de brazo trasero (derecho e izquierdo)
- 4- 4828 juego retén eje trasero y tapón tambor
- 5- 96023 latiguillo freno trasero (220 mm)

## CITROËN SAXO



**531**  
soporte motor izquierdo 1.1-1.4-1.6  
r.o. 1843.95

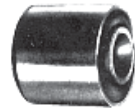

**877**  
silentbloc tirante posterior motor  
r.o. 1809.22

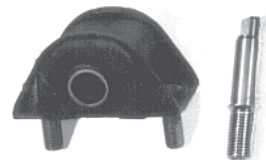

**2386 completo**    **2386/1 sin eje**  
silentbloc posterior trapecio delantero  
r.o. 3523.51 + 3522.44



**2387**  
silentbloc anterior trapecio delantero  
r.o. 3523.50



**2388**  
goma central para barra estabiliz. de 19mm  
r.o. 5094.56



**2389**  
goma central para barra estabiliz. de 21 mm  
r.o. 5094.57



**2666**  
soporte posterior motor completo  
r.o. 1844.54



**2701**                                        **negra**  
goma puntal barra estabilizadora 19 mm  
r.o. 5094.59



**2702**                                        **blanca**  
goma puntal barra estabilizadora 21 mm  
r.o. 5094.60



**2784**  
soporte motor derecho 0.9 - 1.1  
r.o. 1843.99



**2786**  
soporte motor izquierdo Diesel y automátic.  
1844.34



**2959**  
soporte motor derecho 1.4-1.6-1.5D  
r.o. 1844.58 - 1844.60

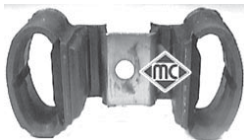

**2960**  
limitador soporte motor dcho. 1.4-1.6-1.5D  
r.o. 1844.59



**2967**  
soporte amortiguador delantero  
r.o. 5038.15



**2968**  
bieleta puntal barra estabilizadora VTS  
r.o. 5087.40



**2970**  
silentbloc anterior trapecio delantero VTS  
r.o. 3523.52



**2974**  
capuchón amortiguador delantero  
r.o. 5254.18



**2989**                                        **con ánima metálica !**  
goma para barra estabilizadora Ø 18 mm  
r.o. 5094.72



**2990**                                        **con ánima metálica !**  
goma para barra estabilizadora de Ø 22 mm  
r.o. 5094.71



**2991**  
tope poliuretano suspensión  
r.o. 5033.35



**4064**  
silentbloc soporte motor trasero  
r.o. no hay despiece

## CITROËN SAXO

 <p><b>4181</b> rodamiento soporte suspensión delantera r.o.5035.23</p>	 <p><b>2838</b> silentbloc puente trasero r.o.5131.63</p>	 <p><b>4499</b> eje brazo trasero derecho e izquierdo r.o.</p>
 <p><b>4563</b> juego rodamientos, retenes y casquillos eje brazo trasero, r.o.</p>	 <p><b>4744</b> tirante posterior motor 1.5D r.o.</p>	 <p><b>4746</b> tirante posterior motor 1.1-1.4-1.6TU r.o.</p>
 <p><b>4828</b> juego retén eje trasero y tapón tambor r.o.3724.24+3740.19</p>	 <p><b>90013</b> buje rueda delantera Ø 129 mm, 21 estrías (hasta '99), r.o. 3307.49</p>	 <p><b>90044</b> buje rueda delantera de 3 agujeros, 1.1 salvo dirección asist. ni ABS, r.o. 3307.74</p>
 <p><b>90045</b> buje rueda delantera Ø 130 mm, 25 estrías (desde '99), r.o. 3307.76</p>	 <p><b>96046</b> latiguillo freno delantero rueda 3 agujeros (355 mm), r.o.4806.55</p>	 <p><b>96180</b> latiguillo freno delantero rueda 4 agujeros (325 mm), r.o.4806.81-4806.56</p>
 <p><b>96023</b> latiguillo freno trasero (220 mm) r.o.4806.81-4806.56</p>		

C- ARTICULACIONES PALANCA DE CAMBIO:

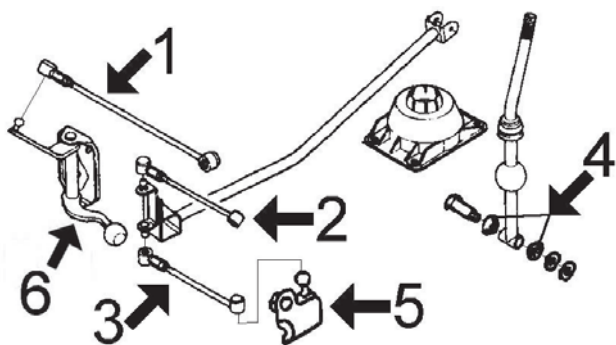

- 1- 2377 bieleta selección cambio velocidades
- 2- 2376 bieleta selección cambio velocidades
- 3- 2375 bieleta selección cambio velocidades
- 4- 2400 casquillo palanca de cambio
- 5- 2396 soporte bieleta inferior
- 6- 4988 articulación reenvío

long. máx. 195 mm  
long. mín. 175 mm  
rótulas de Ø 10 mm



**2375**  
bieleta inferior mando cambio  
r.o. 95636573

long. máx. 190 mm  
long. mín. 175 mm  
rótulas de Ø 10 mm



**2376**  
bieleta central mando cambio  
r.o. 95631090

rótulas de Ø 13 mm



**2377**  
bieleta superior mando cambio  
r.o. 2452.69

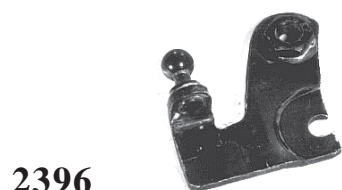

**2396**  
soporte bieleta inferior mando cambio  
r.o. 2163.08



**2400**  
casquillo palanca cambio  
r.o. 95634960



**4988**  
articulación reenvío cambio  
r.o. 2449.65

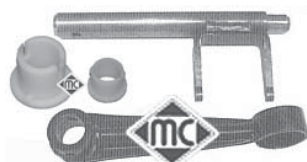

**4300**  
horquilla embrague completa con casquillos  
r.o. 2117.52

¡Nuevo!



**4424** altura 55,50 mm  
casquillo guía embrague con retén  
r.o. 2105.14

¡Nuevo!



**4796** altura 56,50 mm  
casquillo guía embrague con retén  
r.o. 2105.38



**4057**  
juego casquillos horquilla embrague  
r.o. 2175.11+2175.12



**1609**  
fuelle cremallera dirección hasta '98  
r.o. 4066.36



**1064**  
fuelle cremallera asistida desde '98  
r.o. 4066.50



# CITROËN SAXO



**904**  
capuchón izquierdo cremallera dirección  
r.o.4066.32

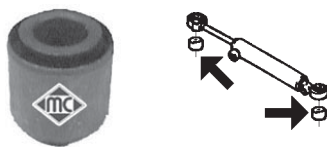

**2911**  
silentbloc pistón cremallera asistida  
r.o.4059.10(12x24x20x24)



**2401**  
casquillo cremallera dirección  
r.o. r.o.



**2958**  
polea cigueñal 1.5 Diesel  
r.o.0515.L6



**4439** **Ø 139 mm 5 canales**  
polea cigueñal 1.6 sin aire acondicionado  
r.o.0515.K8



**4460** **Ø 128 mm 5 canales**  
polea cigueñal 1.6 con aire acondicionado  
r.o.0515.J3



**4593**  
varilla nivel aceite 1.1-1.4-1.6  
r.o.



**4595**  
varilla nivel aceite 1.5 Diesel  
r.o.



**3639**  
tapón llenado aceite 1.1-1.4-1.6 TU  
r.o.0258.55



**3659**  
tapón llenado aceite 1.6-16v  
r.o.0258.65



**4564** **Ø 30/47 y 40/58 mm**  
juego retenes diferencial-transmisión  
r.o.3121.44+3121.46



**1433**  
kit rep. transmisión izquierda l/rda 1.1-1.4  
y 1.5 D, r.o.



**1218**  
kit rep. transmisión derecha l/rda 1.1  
r.o.3293.11



**1434**  
kit rep. transmisión derecha l/rda 1.4-1.5 D  
r.o.3293.93



**1521**  
kit rep. transmisión l/rda 1.6  
r.o.3293.05



**1606**  
kit rep. transmisión l/cambio 0.9-1.1  
r.o.3287.75



**1533**  
kit rep. transmisión l/cambio 1.4-1.5 D (d+i)  
y derecha 1.6, r.o.3287.69



**1537**  
kit rep. transmisión izquierda l/cbo. 1.6  
completo con rodamiento, r.o.3287.89



**3697**  
juego tapas correa distribución 1.1-1.4  
TU1-TU3, r.o.0320.S2/L3



**3696**  
juego tapas correa distribución 1.5 D-TUD5  
r.o.0320.K6/P5

## CITROËN SAXO



**2392** junta de Ø 60 x 46 mm  
kit montaje colector escape 1.1 y 1.5D  
r.o. 1798.76



**2941** junta de Ø 60 x 46 mm  
kit montaje colector escape 1.4  
r.o. 1798.83



**2964** junta de Ø 63 x 48 mm  
kit montaje colector escape 1.6  
r.o. 1798.65



**2692** soporte anterior tubo escape 1.1-1.4-1.6  
r.o. 1755.66

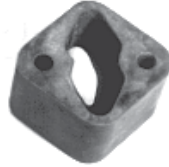

**2417** soporte posterior tubo escape todos  
r.o. 1755.44



**2965** soporte anterior tubo escape 1.5D  
r.o. 1755.70



**2773** cubrepedal freno y embrague  
r.o. 2130.14



**667** tapón cárter de aceite 16x150, 1.1-1.4-1.6  
r.o. 0163.93



**2452** tapón cárter de aceite 14x125, 1.5 Diesel  
r.o. 0311.21



**942** funda Delco  
r.o. 5966.16



**016** tapón cierre inyectores Diesel  
r.o.



**4036** bomba cebado manual Diesel con válvula antirretorno y boquilla adicional a 90°

## CANALIZACIONES DE AGUA

**XANTIA 1.6 (XU5) - 1.8 (XU7) - 1.8-16v (XU7JP4) - 2.0 (XU10) y 2.0-16v (XU10JP4)**  
versiones SINAIRE ACONDICIONADO

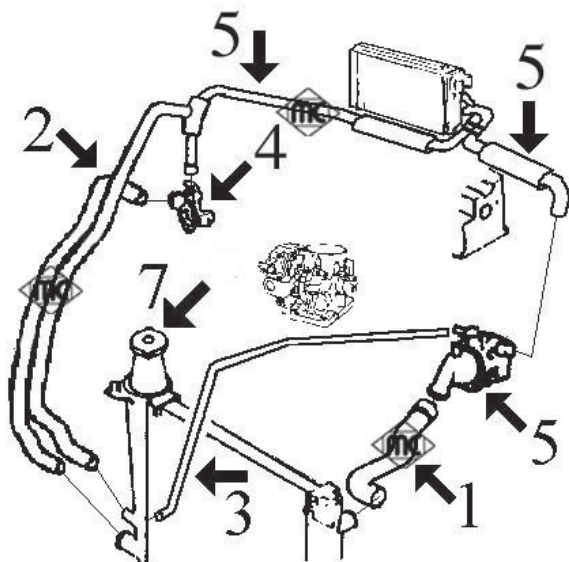

- 1- 8637 mgto superior radiador
- 2- 8640 mgto inferior radiador
- 3- 8663 mgto de radiador a caja termostato
- 4- 3523 racor conexión manguitos
- 5- 8669 mgto doble de calefactor hasta PR-6715 salvo 1.8-16v y 2.0-16v.  
8641 mgto doble de calefactor desde PR-6715 salvo 1.8-16v y 2.0-16v.  
8662 mgto doble de calefactor 1.8-16v y 2.0-16v.
- 6- 3538 tapa de termostato salvo 16v.  
2351 junta de termostato  
3077 boquilla en caja termostato salvo 16v.  
3078 boquilla en caja termostato
- 7- 3608 tapón radiador metálico (1.2 bar)  
3548 tapón de radiador de plástico (1.4 bar)

**DESAPORIZADORES:**

- 8549 mgto desvaporizador 1.6-1.8
- 8550 mgto desvaporizador 1.6-1.8
- 8854 mgto desvaporizador 1.6-1.8

**XANTIA 1.6 (XU5) - 1.8 (XU7) - 1.8-16v (XU7JP4) - 2.0 (XU10) y 2.0-16v (XU10JP4)**  
versiones CONAIRE ACONDICIONADO

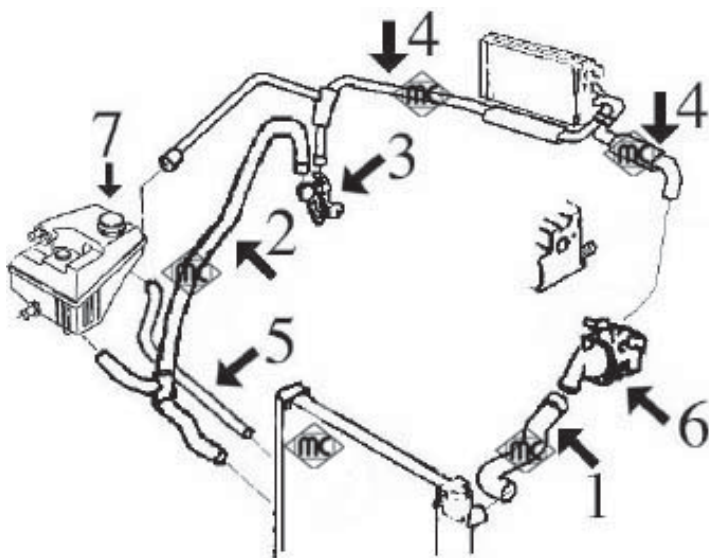

- 1- 8676 mgto superior radiador salvo 16v.  
8638 mgto superior radiador 1.8-16v. y 2.0-16v.
- 2- 8639 mgto inferior radiador
- 3- 3523 racor conexión manguitos
- 4- 8737 mgto doble de calefactor hasta '96  
8641 mgto doble de calefactor desde '96
- 5- 8642 mgto de botella a radiador
- 6- 3538 tapa de termostato salvo 16v.  
2351 junta de termostato  
3077 boquilla en caja termostato salvo 16v.  
3078 boquilla en caja termostato
- 7- 3548 tapón botella expansión 1.4 bar

**DESAPORIZADORES:**

- 8549 mgto desvaporizador 1.6-1.8
- 8550 mgto desvaporizador 1.6-1.8
- 8854 mgto desvaporizador 1.6-1.8

## XANTIA DIESEL 1.9 D (motores XUD9 - XUD9SD) y 1.9 TurboD (motor XUD9TE)

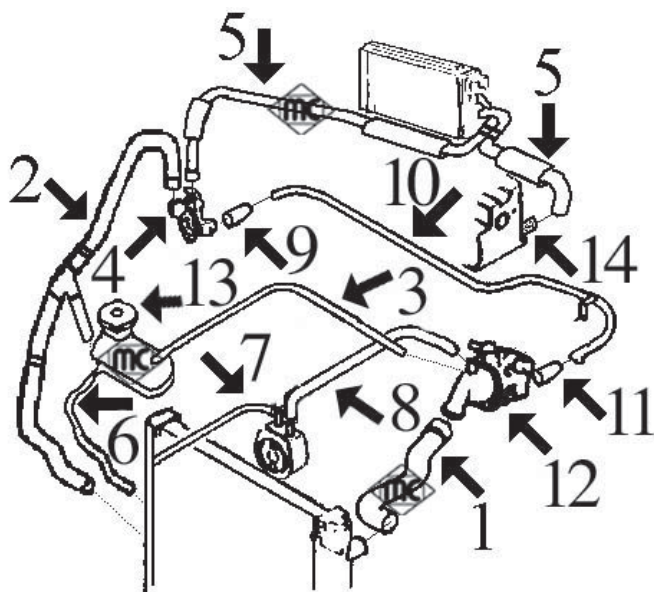

- 1- 8643 mgto superior radiador 1.9 D sin aire acondic.  
8644 mgto superior radiador 1.9 D con aire acondic.  
8645 mgto superior radiador 1.9 TurboD sin aire acond.  
8571 mgto superior radiador 1.9 TurboD con aire acond.
- 2- 8646 mgto inferior radiador 1.9 D sin aire acondicionado (Ø bocas 31-34 mm)  
8639 mgto inferior radiador 1.9 D con aire acondicionado y 1.9 TurboD sin aire acondicionado (Ø bocas 38-31 mm)  
8647 mgto inferior radiador 1.9 TurboD con aire acond. (conexión rápida)
- 3- 8648 mgto de botella a caja termostato
- 4- 3503 racor conexión manguitos
- 5- 8649 mgto doble de calefactor
- 6- 8642 mgto de botella a radiador
- 7- 8672 mgto de intercambiador a radiador 1.9D sin aire ac.  
8650 mgto de intercambiador a radiador 1.9D con aire acondicionado y 1.9SD  
8671 mgto de intercambiador a radiador 1.9 TurboD
- 8- 8313 mgto de intercambiador a caja de termostato
- 9- 8312 mgto e tubo metálico a racor plástico
- 10- 3057 tubo de agua metálico
- 11- 8183 mgto de caja termostato a tubo metálico hasta '96 (Ø bocas 21-21 mm)  
8480 mgto de caja termostato a tubo metálico desde '96 (Ø bocas 22-25 mm)
- 12- 3539 tapa de termostato  
2361 junta de termostato  
3171 boquilla metálica en caja termostato
- 13- 3548 tapón botella de expansión 1.4 bar
- 14- 3059 boquilla metálica en culata

## XANTIA DIESEL 2.1 TurboD (motor XUD11BTE)

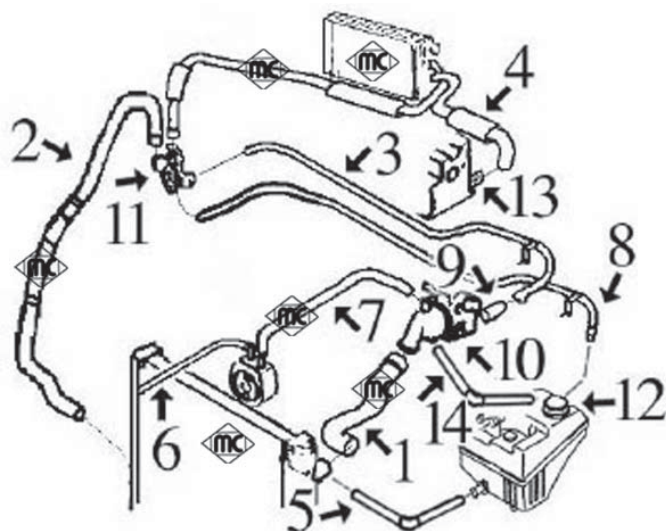

- 1- 8571 mgto superior radiador
- 2- 8653 mgto inferior radiador
- 3- 3137 tubo de agua metálico
- 4- 8655 mgto doble de calefactor
- 5- 116 mgto de botella a radiador, cortar de rollo MC-116 Ø 8x14 mm longitud 650 mm
- 6- 8654 mgto de intercambiador a radiador
- 7- 8313 mgto de intercambiador a caja termostato
- 8- 8657 mgto de botella a racor en bomba de agua
- 9- 8183 mgto de caja termostato a tubo metálico
- 10- 3539 tapa de termostato  
2361 junta de termostato
- 11- n/d racor conexión en bomba de agua
- 12- 3548 tapón botella radiador 1.4 bar
- 13- 3059 boquilla metálica en culata
- 14- 8656 mgto de botella a caja termostato



## XANTIA DIESEL 2.0 HDi

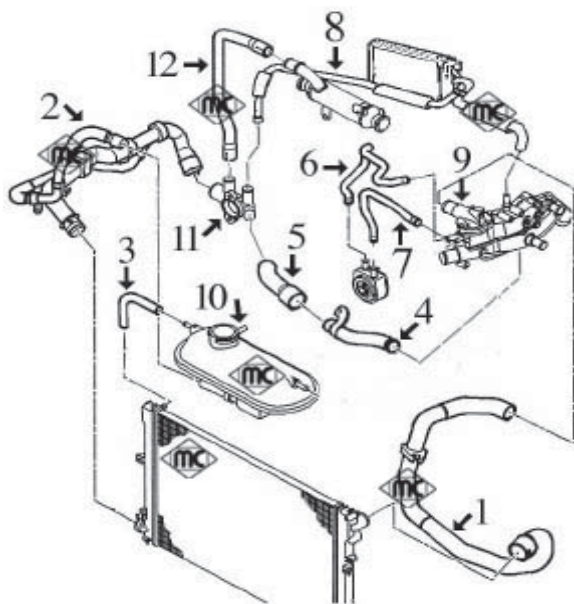

- 1- 8553 mgto superior radiador
- 2- 8646 mgto inferior radiador
- 3- 8651 mgto de botella a radiador
- 4- 3139 tubo de agua metálico
- 5- 8575 mgto de tubo metálico a racor plástico
- 6- 8585 mgto de intercambiador a caja termostato
- 7- 8586 mgto de intercambiador a caja termostato
- 8- 8652 mgto doble de calefactor
- 9- 3135 tapa de termostato
- 10- 3548 tapón botella de expansión
- 11- 3544 racor plástico conexión manguitos
- 12- 8668 mgto de racor a filtro de partículas

## MANGUITOS DESVAPORIZADORES DIESEL

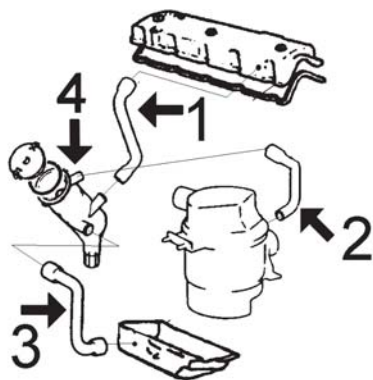

- 1- 8307 mgto de tapa balancines a decantador 1.9D-1.9TD
- 8636 mgto de culata a filtro de aire motor 2.0HDi
- 2- 8167 mgto de decantador a filtro de aire motor 1.9D
- 8552 mgto de decantador a filtro de aire motor 1.9TD
- 8491 mgto de decantador motor 2.1TD
- 3- 8166 mgto de cárter a decantador motores Diesel todos
- 8540 mgto de cárter a culata motor 2.0HDi
- 4- 3631 decantador completo con tapón 1.9D-1.9TD

## CITROËN XANTIA



**8166**

mgto desvaporizador de decantador a cárter Diesel y TurboD, r.o. 1192.48



**8167**

mgto desvaporizador de decantador a filtro Diesel, r.o. 1180.A3



**8183**

mgto de tubo metálico a caja termostato Diesel, r.o. 1307.W3



**8307**

mgto desvaporizador de decantador a tapa balancines Diesel y TurboD, r.o. 1180.86



**8312**

mgto de tubo metálico a brida TurboD r.o. 1307.W4



**8313**

mgto de intercambiador a termost. D-TD r.o. 1307.AA



**8480**

mgto de caja termostato a tubo metálico r.o.



**8491**

mgto desvaporizador 1.9 TD r.o.



**8540**

mgto desvaporizador 2.0 HDi r.o.



**8549**

mgto desvaporizador 1.6 - 1.8 r.o.



**8550**

mgto desvaporizador 1.6 - 1.8 r.o.



**8552**

mgto desvaporizador 1.9 Diesel r.o.



**8553**

mgto superior radiador 2.0 HDi r.o.



**8571**

mgto superior radiador 2.1 TurboD r.o.



**8575**

mgto de caja termostato a tubo 2.0 HDi r.o.



**8585**

mgto de intercambiador a termost. 2.0 HDi r.o.



**8586**

mgto de intercambiador a termost. 2.0 HDi r.o.



**8636**

mgto desvaporizador 2.0 HDi r.o.



**8637**

mgto superior radiador 1.6-1.8 sin a/ac. r.o.



**8638**

mgto superior radiador 1.8-2.0 a/ac. r.o.



**8639**

Ø bocas 38-31 mm  
mgto inferior radiador 1.6-1.8-2.0 a/ac. r.o.

# CITROËN XANTIA



**8640**  
mgto inferior radiador 1.6-1.8-2.0 sin a/ac.  
r.o.



**8641**  
mgto calefactor 1.6-1.8-2.0  
r.o.



**8642**  
mgto de botella a radiador  
r.o.



**8643**  
mgto superior radiador 1.9 D sin a/ac.  
r.o.



**8644**  
mgto superior radiador 1.9 D a/ac.  
r.o.



**8645**  
mgto sup. radiador 1.9 TurboD sin a/ac.  
r.o.



**8646**      Ø bocas 31-34 mm  
mgto inferior radiador 1.9 D  
r.o.



**8647**      racor rápido  
mgto inferior radiador 1.9 TurboD a/ac.  
r.o.

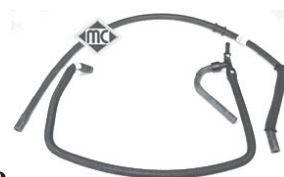

**8648**  
mgto de botella a caja termostato D-TD  
r.o.



**8649**  
mgto calefactor 1.9 D-TD  
r.o.



**8650**  
mgto intercambiador 1.9 D a/ac. y 1.9 SD  
r.o.



**8651**  
mgto de botella a radiador 2.0 HDi  
r.o.



**8652**  
mgto calefactor 2.0 HDi  
r.o.



**8653**  
mgto inferior radiador 2.1 TurboD  
r.o.



**8654**  
mgto intercambiador 2.1 TurboD  
r.o.



**8655**  
mgto calefactor 2.1 TurboD  
r.o.



**8656**  
mgto de botella a caja termostato 2.1 TurboD  
r.o.



**8657**  
mgto de botella a bomba 2.1 TurboD  
r.o.



**8662**  
mgto calefactor 1.8-16v y 2.0 16v  
r.o.



**8663**  
mgto de radiador a caja termostato 1.6-1.8  
r.o.



**8668**  
mgto de racor a filtro de partículas 2.0 HDi  
r.o.

# CITROËN XANTIA



**8669**  
mgto calefactor 1.6-1.8-2.0  
r.o. 96132536



**8671**  
mgto intercambiador 1.9 TurboD  
r.o.



**8672**  
mgto intercambiador 1.9 D sin a/c.  
r.o.



**8676**  
mgto superior radiador 1.6-1.8 aire ac.  
r.o.

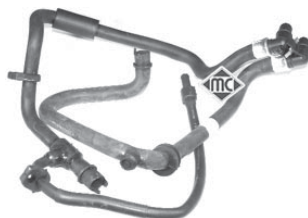

**8737**  
mgto calefactor 1.6-1.8-2.0 con a/ac.  
r.o. 96132555



**8854**  
mgto desvaporizador 1.6-1.8 gasolina  
r.o. 1180.62



**2351** Ø41x47mm **2361** Ø51x58mm  
juntas de termostato 1.6-1.8-2.0 y Diesel  
r.o. 1339.53 y 1339.92



**3057**  
tubo de agua metálico 1.9 D-TD  
r.o. 1307.W2



**3059**  
boquilla en culata 1.9 D-TD y 2.1 TD  
r.o. 0245.44



**3077**  
boquilla en caja termostato 1.6-1.8  
r.o.



**3078**  
boquilla en caja termostato 1.6-1.8  
r.o. 1336.K8



**3135**  
tapa de termostato 2.0 HDi  
r.o. 1336.P2



**3137**  
tubo de agua metálico 2.1 TD con junta  
tórica, r.o.



**3139**  
tubo de agua metálico 2.0 HDi con junta  
r.o. 1307.YZ



**3171**  
boquilla en caja termostato 1.9D-TD  
r.o. 1336.N7



**3503**  
racor conexión manguitos 1.9 D-TD  
r.o. 1336.G4

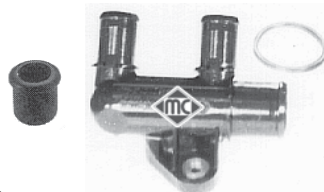

**3523**  
racor conexión manguitos 1.6-1.8-2.0  
r.o. 1336.J7-1336.H7



**3538**  
tapa de termostato 1.6-1.8-2.0  
r.o. 1336.A1



**3539**  
tapa de termostato Diesel todos salvo HDi  
r.o. 1336.C9



**3544**  
racor conexión manguitos 2.0 HDi  
r.o. 1336.P0-1336.Q3



**3548**  
tapón botella expansión / radiador 1.4 bar  
(plástico) r.o. 1336.C7-1336.84



## CITROËN XANTIA



**3608**

tapón de radiador (metálico, 1.2 bar)  
r.o.



**3631**

decantador completo con tapón 1.9D-TD  
r.o. 1180.95

**¡Nuevo!**



**4490**

soporte decantador 1.6-1.8 gasolina  
r.o. 1439.10

### SUSPENSION DELANTERA y SOPORTES DE MOTOR

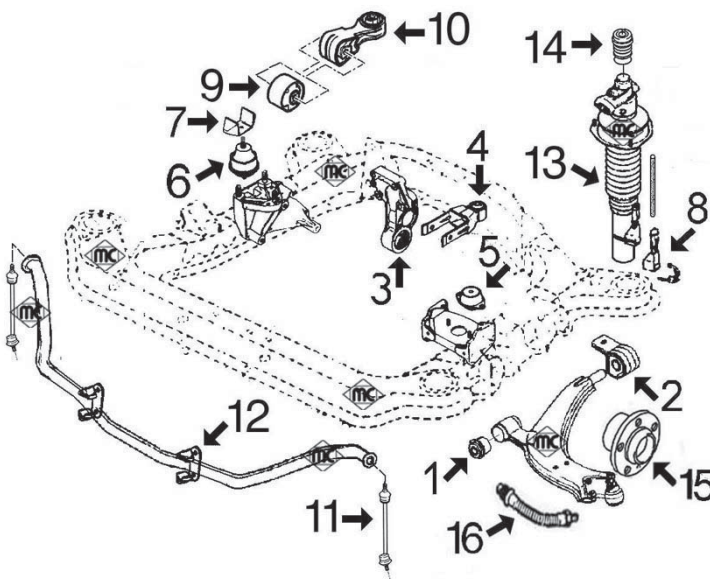

- 1- 2657 silentbloc anterior trapecio delantero
- 2- 2656 silentbloc posterior trapecio delantero izquierdo
- 2825 silentbloc posterior trapecio delantero derecho
- 3- 2869 silentbloc soporte post. motor 1.6-1.8-2.0
- 2980 silentbloc soporte post. motor D y TurboD salvo HDi
- 2966 silentbloc soporte posterior motor HDi
- 4- 4744 tirante posterior motor completo
- 2871 silentbloc tirante post. de motor todos salvo HDi
- 877 silentbloc tirante posterior de motor HDi
- 5- 531 soporte motor izquierdo 1.9 D y 1.6-1.8 (salvo 16v)
- 2794 soporte motor izquierdo 16v. y 1.9 TurboD
- 2943 soporte motor izquierdo 2.1 TurboD y 2.0 HDi
- 6- 2309 soporte motor derecho salvo 2.1 TD y 2.0 HDi
- 2924 soporte motor derecho 2.1 TurboD y 2.0 HDi
- 7- 2884 limitador soporte derecho de motor 1.6-1.8-2.0 y 1.9D-TD
- 8- 2867 juego recuperador líquido de suspensión
- 9- 2869 silentbloc bieleta antipar
- 10- 4006 bieleta antipar hasta 9/'98
- 4486 bieleta antipar desde 9/'98 1.6-1.8-2.0 gasolina
- 4405 bieleta antipar desde 9/'98 1.9D-2.1D-2.0HDi
- 11- 4067 bieleta puntal barra estabilizadora hasta PR6614 (roscas Ø 10 mm)
- 2968 bieleta puntal barra estabilizadora desde PR6615 (roscas Ø 12 mm)
- 12- 4049 goma soporte barra estabilizadora Ø 23 mm
- 4050 goma soporte barra estabilizadora Ø 24 mm
- 13- n/d fuelle columna suspensión
- 14- n/d tope poliuretano suspensión delantera)
- 15- 90012 buje rueda delantera 1.6-1.8-1.9D-1.9TD y 2.0 (sin antibalanceo activo)
- 90066 buje rueda delantera 2.0 (con antibalanceo activo) y 2.1TD
- 16- 96148 latiguillo freno delantero (385 mm)

### SUSPENSION TRASERA

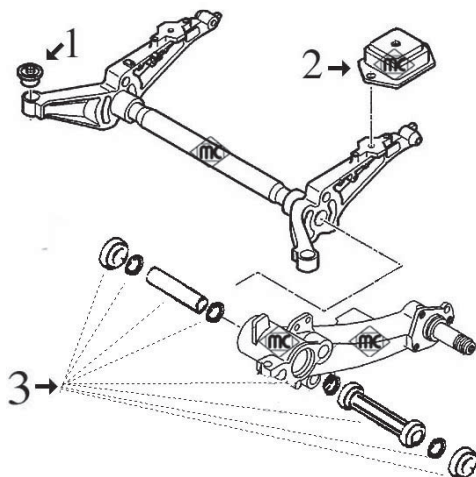

- 1- 4292 silentbloc puente trasero
- 2- 2979 soporte posterior puente trasero
- 3- 2684 juego reparación brazo suspensión completo con rodamientos y tornillo pasador con tuerca

# CITROËN XANTIA



**4067** roscas Ø de 10 mm  
bieleta puntal barra estabilizadora  
r.o. 96145457



**531**  
soporte motor izquierdo 1.6-1.8 y 1.9D  
r.o. 1843.95



**877**  
silentbloc tirante posterior motor HDi  
r.o. 1809.04 (12x30x28x34)



**2309** **HIDRAULICO (950 g.)**  
soporte de motor derecho todos salvo 2.1TD  
y 2.0HDi, r.o. 1844.38



**2309/1** **no hidráulico (610 g.)**  
soporte de motor derecho  
r.o. ----



**2656**  
silentbloc posterior trapecio izquierdo  
r.o.



**2657**  
silentbloc anterior trapecio delantero  
r.o. 96083570



**2684**  
juego reparación brazo suspensión trasero  
completo, r.o. 5132.52+5133.20+5179.12



**2794**  
soporte motor izquierdo 16v. y 1.9 TD  
r.o. 1827.10



**2825**  
silentbloc posterior trapecio derecho  
r.o.



**2867**  
juego recuperador líquido de suspensión  
r.o. 96050399+96127591

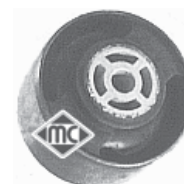

**2869**  
silentbloc soporte posterior motor 1.6-1.8-  
2.0, r.o. 1809.16



**2871**  
silentbloc tirante posterior motor todos sal-  
vo HDi, r.o. 1809.22 (10x30x28x50)



**2884**  
limitador soporte de motor derecho 1.6-1.8-  
1.9D y 1.9 TD, r.o. 1844.25



**2924**  
soporte motor derecho 2.1 TD y 2.0 HDi  
r.o. 1827.14 - 1827.26



**2943**  
soporte motor izquierdo 2.1 TD y 2.0 HDi  
r.o. 1827.16



**2966**  
silentbloc soporte posterior motor HDi  
r.o. 1809.30



**2968** roscas Ø de 12 mm  
bieleta barra estabilizadora delantera  
r.o. 5087.40



**2979**  
soporte posterior puente trasero  
r.o. componente de 5131.75

















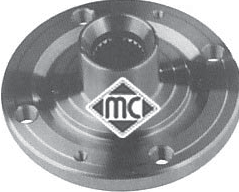



**2980**  
silentbloc soporte motor 1.9D-TD y  
2.1 TD, r.o. 1809.21



**4005**  
bieleta antipar motores Diesel desde 9/98  
r.o. 1806.28

## CITROËN XANTIA

 <p><b>4006</b> tirante antipar motores de gasolina hasta 98 r.o. 1854.20</p>	 <p><b>4049</b> con ánima metálica goma para barra estabilizad. de Ø 23 mm r.o. 96089104</p>	 <p><b>4050</b> con ánima metálica goma para barra estabilizadora de Ø 24 mm r.o. 96089106</p>
 <p><b>4292</b> silentbloc puente trasero r.o. 5131.75</p>	<p><i>¡Nuevo!</i></p>  <p><b>4486</b> bieleta antipar motores de gasolina desde 98 r.o. 1806.34</p>	<p><i>¡Nuevo!</i></p>  <p><b>4744</b> tirante motor trasero completo r.o.</p>
 <p><b>2440</b> racor unión tubos conducción líquido LHM r.o. 5270.14</p>	 <p><b>90012</b> buje rueda delantera 1.6-1.8-1.9D-1.9TD r.o. 3307.69</p>	 <p><b>90066</b> buje rueda delantera 2.0 y 2.1 TurboD r.o. 3307.75</p>
 <p><b>96148</b> latiguillo freno delantero (385 mm) r.o. 96109017</p>		
 <p><b>2926</b> polea cigüeñal 1.9 D y TD r.o. 0515.G3</p>	 <p><b>2976</b> polea cigüeñal 2.1 TD r.o. 0515.J9</p>	 <p><b>2928</b> pola cigüeñal 2.0 HDi r.o. 0515.P2</p>
<p><i>¡Nuevo!</i></p>  <p><b>4481</b> polea cigüeñal 1.8/16v-2.0/16v r.o. 0515.K6</p>	<p><i>¡Nuevo!</i></p>  <p><b>4485</b> polea cigüeñal 1.8-2.0 r.o. 0515.H6</p>	<p><i>¡Nuevo!</i></p>  <p><b>3642</b> tapón llenado aceite 2.0 HDi r.o. 1180.F9</p>
<p><i>¡Nuevo!</i></p>  <p><b>4612</b> varilla nivel aceite motor 1.9D-TD (XUD9) r.o. 1174.15</p>	<p><i>¡Nuevo!</i></p>  <p><b>4594</b> varilla nivel aceite motor 2.0 HDi r.o. 1174.61</p>	 <p><b>2931</b> tensor correa alternador 1.9 TD completo r.o. 5751.81</p>



# CITROËN XANTIA

**¡Nuevo!**



**4992**  
articulación reenvío cambio velocidades  
r.o. 2449.87

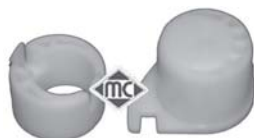

**4043**  
juego casquillos horquilla embrague 1.9TD  
r.o. 2175.20+2175.21



**4044**  
juego casquillos horquilla embrague con  
retenes, 2.1TD/2.0HDI, r.o. 2175.49-2109.53



**4052**  
horquilla embrague completa 1.9 D y TD  
con casquillos, r.o. 2115.25

**¡Nuevo!**



**4799**  
horquilla embrague completa 2.1TD-2.0HDI  
con casquillos, r.o. 2117.59



**2865**  
bieleta mando reenvío cambio velocidades  
r.o. 2454.E5



**2866**  
bieleta mando reenvío cambio velocidades  
r.o. 2452.76

**¡Nuevo!**



**4605**  
casquillo guía embrague  
r.o. 2105.35



**1515**  
fuelle izquierdo cremallera asistida d/'97  
r.o.



**1310**  
fuelle cremallera dirección (manual, fuelle  
dcho. e izqd., asistida izqd.), r.o. 4066.37



**1845**  
fuelle derecho cremallera asistida  
r.o. 4066.28

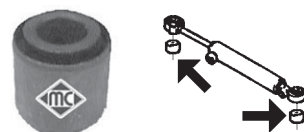

**2911**  
silentbloc pistón cremallera asistida  
hasta '96, r.o. 4059.10 (12x24x20x24)



**844**  
capuchón derecho cremallera asistida  
r.o. 4066.21



**1493**  
kit rep. transmisión l/rda 1.6-1.8 hasta '97  
r.o. 3293.83



**1708**  
kit rep. transmisión Diesel y TD hasta '97  
salvo 2.1 TD, r.o. 3293.91



**2305**  
kit rep. transmisión izquierda l/rda 1.6-1.8-D  
y TD desde '97, r.o. 3293.96



**1839**  
kit rep. transmisión izquierda l/cbo 1.6-1.8-D  
y TD hasta '97, r.o. 3287.79



**1222**  
kit rep. transmisión derecha l/rda 1.6-1.8-D  
y TD desde '97, r.o. 3293.03



**1213**  
kit rep. transmisión derecha l/cbo 1.6-1.8-D  
y TD (salvo 2.1) desde '97, r.o. 3287.81



**1460**  
kit rep. transmisión derecha l/rda 2.0-2.1TD  
y 2.0HDI, r.o.



**1225**  
kit rep. transmisión izquierda l/rda 2.0-  
2.1TD y 2.0HDI, r.o.



# CITROËN XANTIA



**1467**

kit rep. **transmisión derecha** l/cbo 2.0-2.1TD-2.0HDi, r.o.



**1741**

kit rep. **transmisión izquierda** l/cbo 2.0-2.1TD y 2.0HDi, r.o.

**¡Nuevo!**



**4564**

Ø 30/47 y 40/58 mm  
juego retenes diferencial-transmisión 1.6-1.8-1.9D-TD, r.o. 3124.46+3121.44

**¡Nuevo!**



**4620**

Ø 32/50 y 40/58 mm  
juego retenes diferencial-transmisión 2.0-2.1TD y 2.0HDi, r.o. 3121.44+3121.24

**¡Nuevo!**

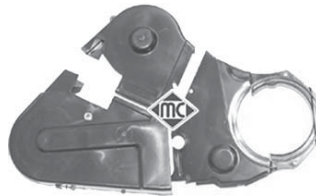

**3698**

juego tapas correa distribución 1.9XUD  
r.o. 0320.H2/H3/F9

**¡Nuevo!**



**3699**

juego tapas correa distribución 2.0HDi  
r.o. 0320.N5/N6/S7

**¡Nuevo!**

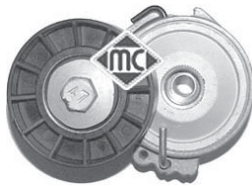

**4807**

tensor correa alternador 2.0HDi  
r.o. 5751.55

**¡Nuevo!**



**4609**

tensor correa alternador 1.9D sin A/C  
r.o. 5751.38

**¡Nuevo!**



**4826**

tensor correa alternador 1.9D-2.1TD A/C  
r.o. 5751.30

**¡Nuevo!**



**4915**

Ø 54,60 mm  
polea de alternador **de rueda libre**  
r.o.

**¡Nuevo!**



**4916**

Ø 58,50 mm  
polea de alternador **de rueda libre**  
r.o.

**¡Nuevo!**



**4929**

Ø 17-90 / 25 mm  
rodillo tensor correa alternador 1.6-1.8-2.0  
r.o. 5751.20

**¡Nuevo!**



**4895**

tensor correa alternador 1.8-2.0  
r.o. 5751.35

**¡Nuevo!**



**4995**

rodillo tensor correa alternador 2.0HDi A/C  
r.o. 5751.29

**¡Nuevo!**



**4996**

rodillo tensor correa alternador 2.0HDi sin A/C, r.o. 5751.96-5751.57



**2392**

Ø 60 x 46 mm  
kit montaje colector escape 1.9 D  
r.o. 1798.76



**2940**

Ø 80 x 66 mm  
kit montaje colector escape 1.6-1.8-2.0-2.1TD y 2.0HDi, r.o.



**4039**

Ø 71 x 58 mm  
kit montaje colector escape 1.9SD - 1.9 TD  
r.o. 1798.74



**084**

soporte tubo de escape  
r.o. 1755.59



**4060**

soporte tubo de escape  
r.o. 1755.77



**2753**

soporte tubo de escape  
r.o. 1755.63

## CITROËN XANTIA



**2770**  
cubrepedal freno  
r.o. 4504.12



**2771**  
cubrepedal embrague  
r.o. 2130.13



**2772**  
cubrepedal acelerador  
r.o. 1604.07



**667**  
tapón de cárter 16x150 (todos hasta '96)  
r.o. 93502063



**2452**  
tapón de cárter 14x125  
r.o. 0311.21



**2024**  
arandela tapón de cárter con retén de goma  
r.o.



**4036**  
bomba manual cebado gasoil con válvula  
antirretorno y boquilla adicional a 90°



**942**  
capuchón distribuidor  
r.o.



**4479**  
jgo soportes tapa motor 2.0HDI  
r.o. 0137.11+0137.23

## SUSPENSION DELANTERA y SOPORTES DE MOTOR

**2.1 Diesel motor XUD11**

**2.0 gasolina 2.0 motores XU10J2 y XU10J2TE (Turbo)**

**(versiones no disponibles: Diesel Turbo motor DK5ATE ni 3.0 gasolina V6)**

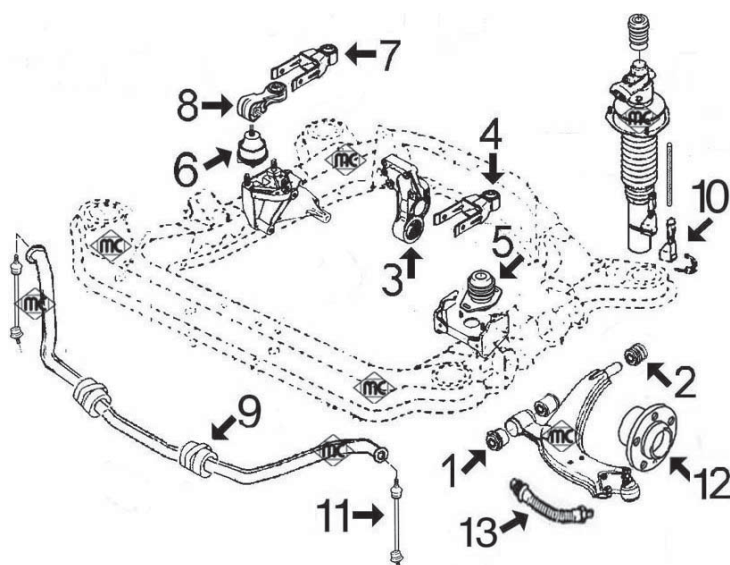

- 1- 4963 silentbloc anterior trapecio delantero
- 2- 4962 silentbloc posterior trapecio delantero
- 3- 2869 silentbloc soporte posterior motor hasta '94  
2980 silentbloc soporte posterior motor desde '94
- 4- 4744 tirante posterior motor
- 5- 2794 soporte motor izquierdo 2.0 gasolina  
2943 soporte motor izquierdo 2.1 Diesel
- 6- 2924 soporte motor derecho 2.0 gasolina  
2944 soporte motor derecho 2.1 Diesel
- 7- 4745 bieleta antipar en soporte derecho 2.0-2.1D
- 8- n/d tirante de reacción
- 9- 2932 goma para barra estabilizadora de Ø 22 mm  
2691 goma para barra estabilizadora de Ø 24 mm
- 10- 2867 juego recuperador líquido de suspensión
- 11- 4959 bieleta puntal barra estabilizadora
- 12- n/d buje rueda delantera
- 13- n/d latiguillo freno delantero



**2691**

goma para barra estabilizadora de Ø 22 mm  
r.o.



**2794**

soporte motor izquierdo 2.0 gasolina  
r.o. 1827.10



**2867**

juego recuperador líquido de suspensión  
r.o. 96050399+96127591



**2869**

silentbloc en soporte motor trasero hasta  
'94, r.o. 1809.16



**2924**

soporte motor derecho 2.0 gasolina  
r.o. 1827.22



**2932**

goma para barra estabilizadora de Ø 24 mm  
r.o. 5094.77



**2943**

soporte motor izquierdo 2.1 Diesel  
r.o. 1827.16



**2944**

soporte motor derecho 2.1 Diesel  
r.o.



**2980**

silentbloc en soporte motor trasero desde  
'94-, r.o. 1809.21

# CITROËN XM

**¡Nuevo!**



**4744**  
tirante posterior motor  
r.o. 1854.16

**¡Nuevo!**



**4745**  
bieleta en tirante de reacción derecho  
r.o. 1854.14

**¡Nuevo!**



**4959**  
bieleta puntal barra estabilizadora  
r.o. 5087.49

**¡Nuevo!**



**4962**  
silentbloc posterior trapecio delantero  
r.o. 3523.96-3523.45

**¡Nuevo!**



**4963**  
silentbloc anterior trapecio delantero  
r.o. 3523.43

**¡Nuevo!**



**4960**  
bieleta **izquierda** barra estabilizadora trasera  
r.o. 5178.43

**¡Nuevo!**



**4961**  
bieleta **derecha** barra estabilizadora trasera  
r.o. 5178.44



**4411**  
polea cigüeñal 2.1 Diesel hasta '95  
r.o. 0515.F8



**2976**  
polea cigüeñal 2.1 Diesel desde '95  
r.o. 0515.J9



**4201**  
polea cigüeñal TurboD motor DK5 ATE  
r.o. 0515.H3



**4052**  
horquilla embague completa 2.0 gasolina  
r.o. 2115.25

**¡Nuevo!**

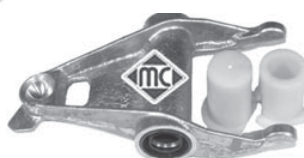

**4799**  
horquilla embague completa TurboD-DK5  
r.o. 5117.59

**¡Nuevo!**



**4605**  
casquillo guía embague  
r.o. 2105.35



**1943**  
kit fuelle lado rueda hasta '93  
r.o.



**1362**  
kit fuelle lado cambio hasta '93  
r.o. 3293.59



**2305**  
kit fuelle lado rueda desde '93  
r.o. 3293.96



**1839**  
kit fuelle lado cambio desde '93  
r.o. 3287.79

**¡Nuevo!**



**4564**      Ø 30/47 y 40/58 mm  
juego retenes diferencial-transmisión  
r.o. 3124.46+3121.44

**¡Nuevo!**



**4620**      Ø 32/50 y 40/58 mm  
juego retenes diferencial-transmisión  
r.o. 3121.44+3121.24



# CITROËN XM



**1515**  
fuelie izquierdo cremallera dirección  
r.o.4066.42



**1536**  
fuelie derecho cremallera dirección  
r.o.4066.30

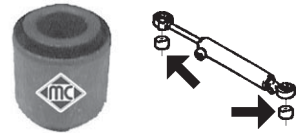

**2911**  
silentbloc pistón cremallera asistida  
r.o.4059.10 (12x24x20x24)



**844**  
capuchón derecho cremallera asistida  
r.o.4066.21



**3548**  
tapón botella de expansión  
r.o.1306.84-1306.C7

**¡Nuevo!**



**4929**  
rodillo tensor correa alternador 2.0 con A/C  
r.o.5751.20

**¡Nuevo!**



**4895**  
tensor correa alternador 2.0 con A/C  
r.o.5751.35

**¡Nuevo!**



**4826**  
tensor correa alternador XUD con A/C  
A/C, r.o.5751.30

**¡Nuevo!**



**4995**  
rodillo tensor correa alternador XUD  
con A/C, r.o.5751.29

**¡Nuevo!**



**4609**  
tensor correa alternador XUD11 sin A/C  
r.o.5751.38

**¡Nuevo!**



**4915** Ø 54,60 mm  
polea de alternador de rueda libre  
r.o.

**¡Nuevo!**



**4916** Ø 58,50 mm  
polea de alternador de rueda libre  
r.o.



**2940** junta de Ø 80 x 66 mm  
kit montaje colector escape 2.0-2.1D  
r.o.1798.75-1798.80



**084**  
soporte tubo de escape  
r.o.1755.59



**749**  
collarín escape  
r.o.



**2770**  
cubrepedal freno  
r.o.4504.12



**2771**  
cubrepedal embrague  
r.o.2130.13

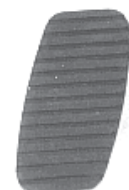

**2772**  
cubrepedal acelerador  
r.o.1604.07



**667**  
tapón de cárter 16x150 (todos hasta '96)  
r.o.93502063



**2452**  
tapón de cárter 14x125  
r.o.0311.21



**2024**  
arandela tapón de cárter con retén de goma  
r.o.

CANALIZACIONES DE AGUA

**XSARA 1.4 y 1.6 motor TU (TU3MC de 1360 cc y TU5JP de 1587 cc) hasta modelo '2000:**

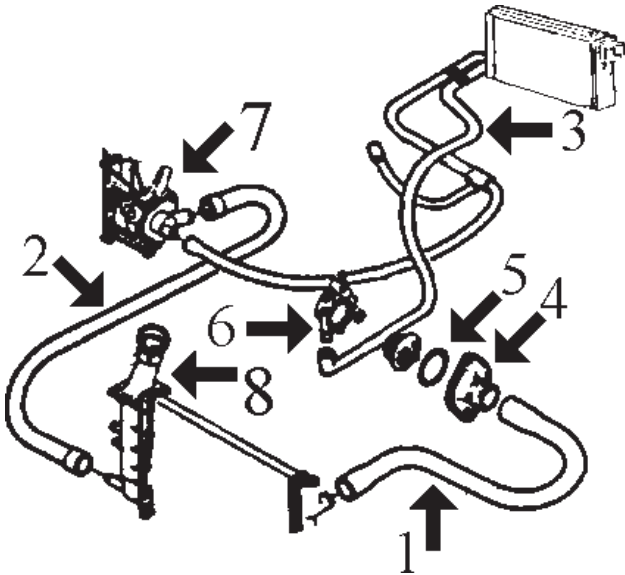

- 1- 8266 mgto superior radiador 1.4 sin aire acondicionado hasta '98
- 8606 mgto superior radiador 1.4-1.6 sin aire acondicionado desde '98
- 8298 mgto superior radiador 1.4 con aire acond. y 1.6 todos hasta '98
- 8607 mgto superior radiador 1.4-1.6 con aire acondicionado desde '98
- 2- 8265 mgto inferior radiador 1.4 y 1.6 hasta '98
- 8476 mgto inferior radiador 1.4 y 1.6 desde '98
- 2113 junta tórica conector rápido mgto inferior hasta '98
- 3- 8300 mgto doble de calefactor 1.4 hasta '98
- 8302 mgto doble de calefactor 1.6 hasta '98
- 8535 mgto doble de calefactor 1.4-1.6 desde '98
- 4- 3011 tapa de termostato hasta '98
- 3611 tapa con termostato desde '98
- 5- 2351 junta de termostato hasta '98
- 6- 3081 boquilla metálica caja termostato Ø 16 mm
- 3082 boquilla metálica caja termostato Ø 10 mm
- 7- 3578 tapa bomba de agua 1.4
- 3640 boquilla en bomba de agua 1.6
- 8- 3548 tapón de radiador
  
- 8541 mgto desvaporizador 1.6
- 8542 mgto desvaporizador 1.6

**XSARA-XSARA PICASSO 1.4 y 1.6 motores TU (TU3MC de 1360 cc y TU5JP de 1587 cc) desde modelo '2001:**

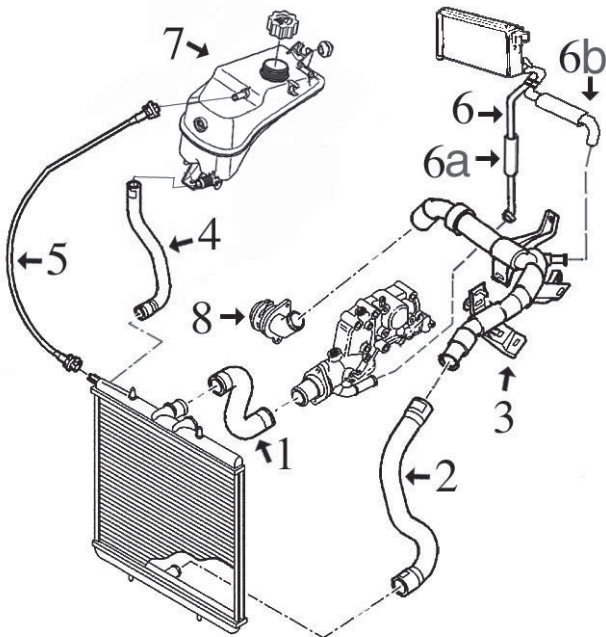

- 1- 8618 mgto superior radiador 1.4 y Picasso
- 8619 mgto superior radiador 1.6 salvo Picasso
- 8624 mgto inferior radiador Picasso
- 2- 8621 mgto inferior radiador salvo Picasso
- 3- n/d tubo de mgto superior a bomba
- 4- n/d mgto de botella a radiador
- 5- 116 mgto de radiador a botella, cortar de rollo MC-116 Ø 8 x 14 mm, longitud 580 mm.
- 6- 8623 mgto doble calefactor salvo Picasso
- 6a- 8661 mgto de calefactor a caja termostato Picasso
- 6b- 8660 mgto de calefactor a tubo Picasso
- 7- 3658 botella de expansión
- 3560 tapón botella expansión 1.4 bar
- 8- 3641 tapa bomba de agua 1.4
- 3640 tapa bomba de agua 1.6

## CITROËN XSARA - XSARA PICASSO

**XSARA 1.8 y 2.0 (motores XU7JP de 1761 cc y XU10J4 de 1998 cc) hasta modelo '2001:**

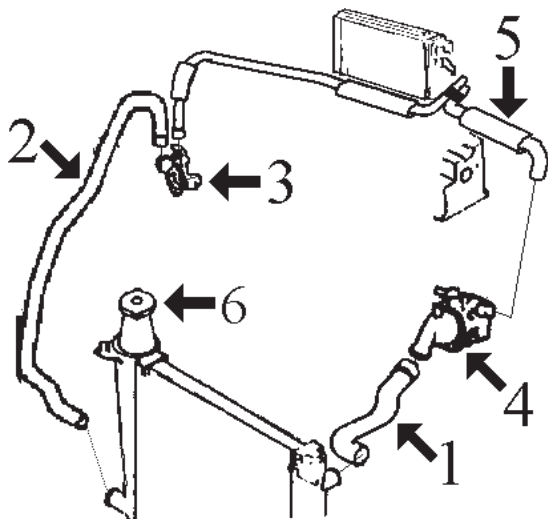

- 1- 8609 mgto superior radiador 1.8  
8670 mgto superior radiador 2.0
- 2- 8294 mgto inferior radiador hasta '98  
8477 mgto inferior radiador desde '98
- 3- 3523 racor de conexión
- 4- 3538 tapa de termostato  
2351 junta de termostato  
3077 boquilla metálica en caja termostato Ø 19 mm  
3078 boquilla metálica en caja termostato Ø 10 mm
- 5- 8610 mgto doble de calefactor
- 6- 3548 tapón de radiador 1.4 bar

**XSARA 1.9 Diesel hasta '99 (motor XUD9) y TurboDiesel hasta '01 (motor XUD9TE)**

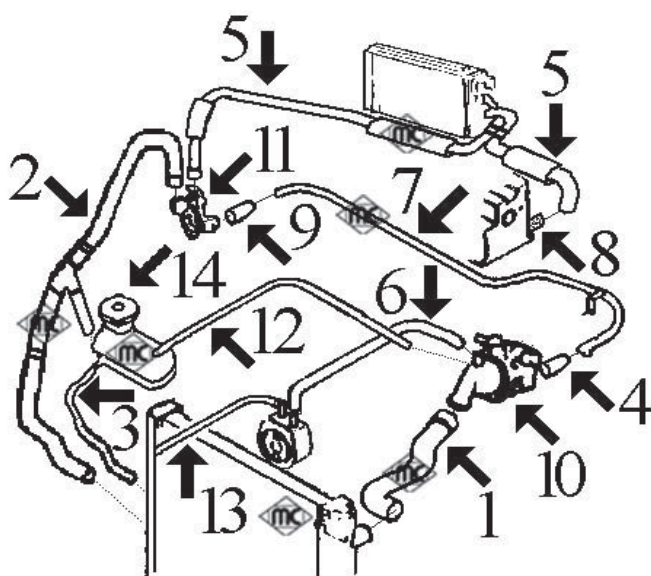

- 1- 8437 mgto superior radiador
- 2- 8664 mgto inferior radiador
- 3- 116 mgto de radiador a botella, cortar de rollo MC-116 Ø 8 x 14 mm, longitud 250 mm.
- 4- 8480 mgto de caja termostato a tubo metálico
- 5- 8303 mgto doble de calefactor hasta '98  
8482 mgto doble de calefactor desde '98
- 6- 8313 mgto de intercambiador a caja termostato
- 7- 3057 tubo de agua metálico
- 8- 3059 boquilla en culata
- 9- 8312 mgto de tubo metálico a brida conexión mgto.
- 10- 3539 tapa de termostato  
2361 junta de termostato Ø 51x58 mm  
3171 boquilla metálica en caja termostato
- 11- 3503 brida agua conexión mgto.
- 12- 8616 mgto de botella a caja termostato
- 13- 8438 mgto de intercambiador a radiador
- 14- 3653 botella de expansión  
3548 tapón botella expansión 1.4 bar

**DESVAPORIZADORES:**

- 8307 mgto de tapa balancines a decantador
- 8166 mgto de cárter a decantador
- 8167 mgto de decantador a filtro de aire

XSARA 1.9 Diesel desde '99 hasta '01, motor DW8

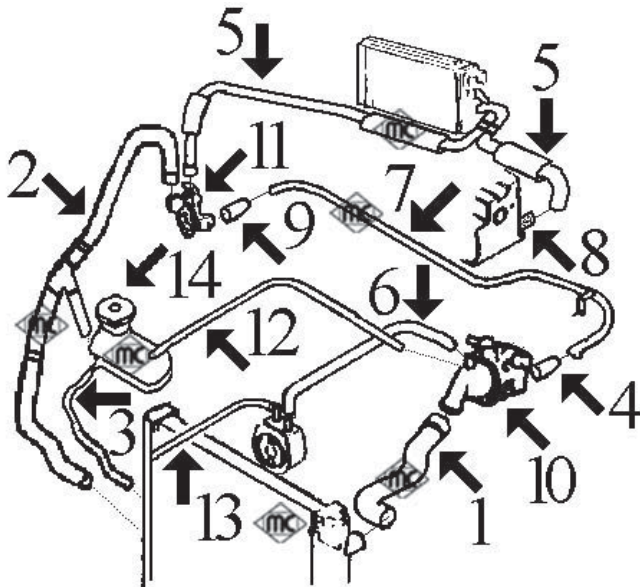

- 1- 8437 mgto superior radiador
- 2- 8664 mgto inferior radiador
- 3- 116 mgto de radiador a botella, cortar de rollo MC-116 Ø 8 x 14 mm, longitud 250 mm.
- 4- 8480 mgto de caja termostato a tubo metálico
- 5- 8303 mgto doble de calefactor 1.9 D hasta '00
- 8482 mgto doble de calefactor 1.9 D desde '01
- 6- 8313 mgto de intercambiador a caja termostato
- 7- 3129 tubo metálico
- 8- 3059 boquilla en culata
- 9- 8312 mgto de tubo metálico a brida conexión mgts.
- 10- 3539 tapa de termostato
- 2361 junta de termostato Ø 51x58 mm
- 3171 boquilla metálica en caja termostato
- 11- 3503 brida agua conexión mgts.
- 12- 8616 mgto de botella a caja termostato
- 13- 8438 mgto de intercambiador a radiador
- 14- 3653 botella de expansión
- 3548 tapón botella expansión 1.4 bar

- 8474 mgto desvaporizador
- 8475 mto desvaporizador

XSARA 2.0 Diesel HDI desde '00 a '01, motor DW10

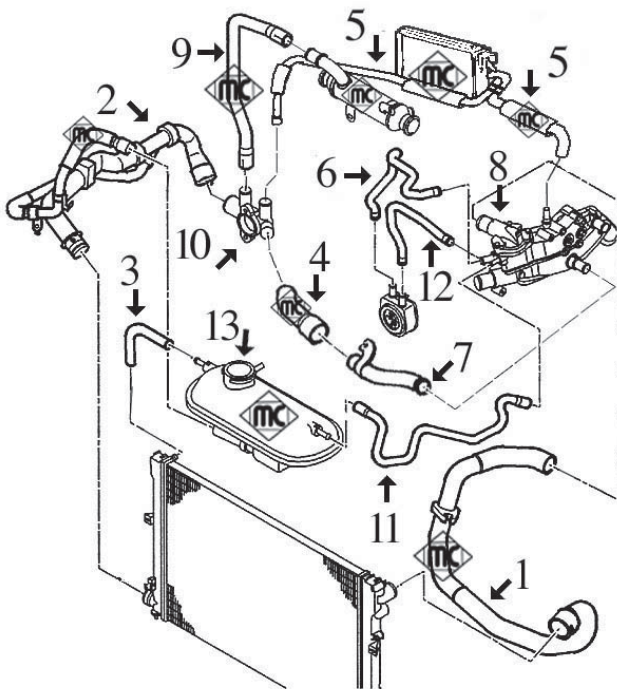

- 1- 8553 mgto superior radiador
- 2- 8664 mgto inferior radiador
- 3- 116 mgto de botella a radiador, cortar de rollo MC-116, Ø 8x14 longitud 250 mm
- 4- 8575 mgto de racor plástico a tubo metálico
- 5- 8555 mgto doble de calefactor
- 6- 8585 mgto de intercambiador a caja termostato
- 7- 3139 tubo de agua metálico
- 8- 3135 tapa de termostato (aluminio)
- 3556 tapa de termostato (plástico)
- 9- 8668 mgto de racor a filtro de partículas
- 10- 3544 racor plástico conexión manguitos
- 11- 8617 mgto de botella a caja de termostato
- 12- 8478 mgto de intercambiador a caja de termostato
- 13- 3653 botella de expansión
- 3548 tapón botella de expansión

- 8540 mgto desvaporizador



# CITROËN XSARA - XSARA PICASSO

## XSARA 1.9 Diesel desde '01, motor DW8

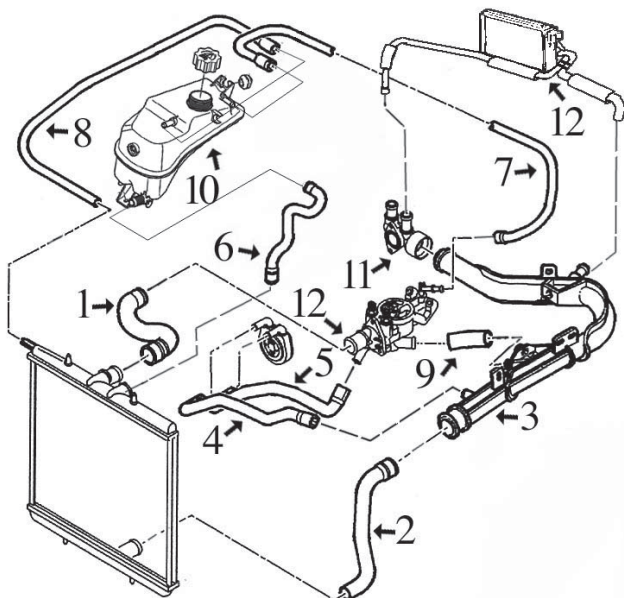

- 1- 8620 mgtto superior radiador
- 2- 8625 mgtto inferior radiador
- 3- n/d tubo de manguito superior a racor
- 4- 8628 mgtto de caja termostato a intercambiador
- 5- 8558 mgtto de caja termostato a intercambiador
- 6- n/d mgtto de botella a radiador (inferior)
- 7- 8629 mgtto de caja termostato a botella
- 8- 116 mgtto de botella a radiador, cortar de rollo MC-116, Ø 8x14 longitud 250 mm.
- 9- 8627 mgtto de caja termostato a tubo
- 10- 3658 botella de expansión  
3560 tapón botella expansión 1.4 bar
- 11- 3555 racor conexión manguitos
- 12- 8626 mgtto doble de calefactor
- 13- 3539 tapa de termostato

- 8474 mgtto desvaporizador
- 8475 mgtto desvaporizador

## XSARA-XSARA PICASSO 2.0 HDi desde '01, motor DW10

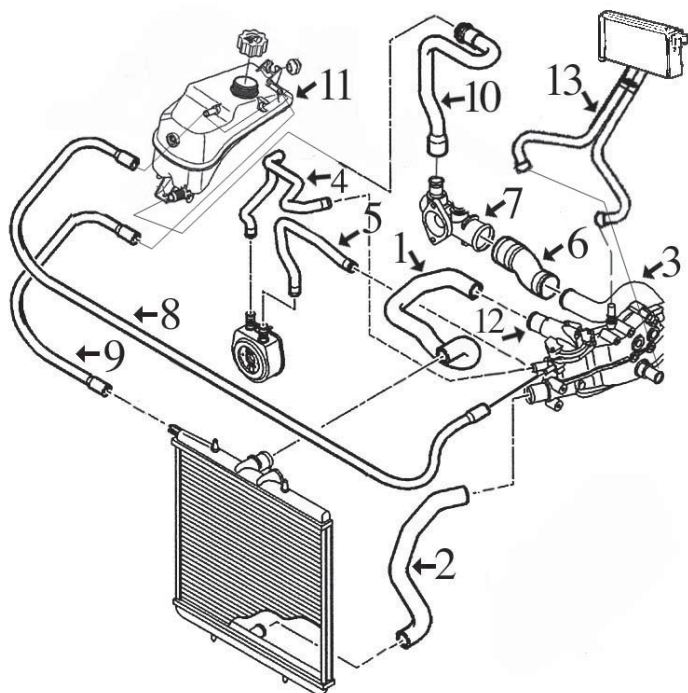

- 1- 8630 mgtto superior radiador berlina (no Picasso)  
8622 mgtto superior radiador Picasso
- 2- 8631 mgtto inferior radiador berlina (no Picasso)  
8633 mgtto inferior radiador Picasso
- 3- 3139 tubo de agua metálico
- 4- 8554 mgtto de intercambiador a caja termostato
- 5- 8586 mgtto de intercambiador a caja termostato
- 6- 8587 mgtto de tubo metálico a racor
- 7- 3554 racor plástico conexión manguitos
- 8- 8629 mgtto de botella a caja termostato
- 9- 116 mgtto de botella a radiador, cortar de rollo MC-116, Ø 8x14 longitud 530 mm (berlina)  
8635 mgtto de botella a radiador Picasso
- 10- n/d no es aplicable en este modelo
- 11- 3658 botella de expansión  
3560 tapón botella expansión 1.4 bar
- 12- 3135 tapa de termostato (aluminio)  
3556 tapa de termostato (plástico)
- 13- 8632 mgtto doble de calefactor salvo Picasso  
8634 mgtto calefactor Picasso (juego completo 3 tubos)

- 8540 mgtto desvaporizador

## CITROËN XSARA - XSARA PICASSO



**8166**  
mgto desvaporizador D y TD  
r.o. 1192.48



**8167**  
mgto desvaporizador D y TD  
r.o. 1180.A3 - 1192.61



**8265**  
mgto inferior radiador 1.4-1.6  
r.o. 1351.J4



**8266**  
mgto superior radiador 1.4-1.6  
r.o. 1343.J2 - 1343.V6



**8294**  
mgto inferior radiador 1.8-2.0  
r.o. 1351.N1



**8298**  
mgto superior radiador 1.4-1.6  
r.o. 1343.J3



**8300**  
mgto doble calefactor 1.4  
r.o. 6464.S3



**8302**  
mgto doble calefactor 1.6  
r.o. 6464.KX



**8303**  
mgto doble calefactor D-TD  
r.o. 6464.NG - 6464.FZ



**8307**  
mgto desvaporizador Diesel y TD  
r.o. 1180.86



**8312**  
mgto de tubo metálico a brida Diesel y TD  
r.o. 1307.W4



**8313**  
mgto de intercambiador a termostato D  
r.o. 1307.AA



**8437**  
mgto superior radiador D-TD  
r.o. 1343.X2



**8438**  
mgto de intercambiador a radiador  
r.o. 1307.JP



**8474**  
mgto desvaporizador Diesel  
r.o.



**8475**  
mgto desvaporizador Diesel  
r.o.



**8476**  
mgto inferior radiador 1.4-1.6  
r.o.



**8477**  
mgto inferior radiador 1.8-2.0  
r.o.



**8478**  
mgto de intercambiador a caja termost.  
r.o.













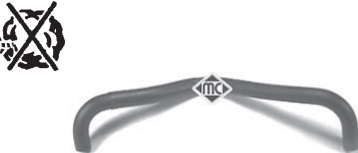





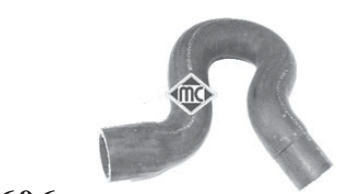

**8480**  
mgto de caja termost. a tubo metálico D-TD  
r.o.



**8482**  
mgto doble calefactor D-TD-DW8  
r.o.

## CITROËN XSARA - XSARA PICASSO

 <p><b>8535</b> mgto doble calefactor 1.4 r.o.</p>	 <p><b>8540</b> mgto desvaporizador 2.0 HDi r.o.</p>	 <p><b>8541</b> mgto desvaporizador 1.6 r.o.</p>
 <p><b>8542</b> mgto desvaporizador 1.6 r.o.</p>	 <p><b>8553</b> mgto superior radiador 2.0 HDi r.o.</p>	 <p><b>8554</b> mgto de intercambiador a caja 2.0 HDi r.o.</p>
 <p><b>8555</b> mgto doble calefactor 2.0 HDi r.o.</p>	 <p><b>8558</b> mgto intercambiador a caja termostato r.o.</p>	 <p><b>8575</b> mgto de tubo metálico a racor 2.0 HDi r.o.</p>
 <p><b>8585</b> mgto de intercambiador a caja termostato 2.0 HDi, r.o.</p>	 <p><b>8586</b> mgto de intercambiador a caja termostato r.o.</p>	 <p><b>8587</b> mgto de tubo metálico a pipa colector HDi r.o.</p>
 <p><b>8606</b> mgto superior radiador 1.4-1.6 r.o.</p>	 <p><b>8607</b> mgto superior radiador 1.4-1.6 r.o.</p>	 <p><b>8609</b> mgto superior radiador 1.8-16v - 2.0-16v r.o.</p>
 <p><b>8612</b> mgto de radiador a racor 1.9 DW8 r.o.</p>	 <p><b>8616</b> mgto de botella a caja termostato 1.9D-TD r.o.</p>	 <p><b>8617</b> mgto de botella a caja termostato 2.0 HDi r.o.</p>
 <p><b>8618</b> mgto superior radiador 1.4 r.o.</p>	 <p><b>8619</b> mgto superior radiador 1.6 r.o.</p>	 <p><b>8620</b> mgto superior radiador 1.9 DW8 r.o.</p>

## CITROËN XSARA - XSARA PICASSO



**8621**  
mgto inferior radiador 1.4-1.6  
r.o.



**8622**  
mgto superior radiador Picasso 2.0 HDi  
(no berlina), r.o.



**8623**  
mgto doble calefactor 1.4-1.6  
r.o.



**8624**  
mgto inferior radiador Picasso 1.6  
r.o.



**8625**  
mgto inferior radiador 1.9 D  
r.o.



**8626**  
mgto doble calefactor 1.9 D  
r.o.



**8627**  
mgto caja termostato a tubo 1.9 D  
r.o.



**8628**  
mgto intercambiador 1.9 D  
r.o.



**8629**  
mgto de botella a caja termostato 2.0 HDi  
r.o.



**8630**  
mgto superior radiador Xsara 2.0 HDi  
(no Picasso) r.o.



**8631**  
mgto inferior radiador 2.0 HDi desde '01  
r.o.



**8632**  
mgto doble calefactor 2.0 HDi  
r.o.



**8633**  
mgto inferior radiador Picasso 2.0 HDi  
r.o.



**8634**  
mgto calefactor Picasso 2.0 HDi  
r.o.



**8635**  
mgto de botella a radiador Picasso 2.0 HDi  
r.o.



**8660**  
mgto calefactor 1.4 - 1.6  
r.o.



**8661**  
mgto calefactor 1.4 - 1.6  
r.o.



**8664**  
mgto inferior radiador Diesel y TurboD  
r.o.



**8668**  
mgto de racor a filtro de partículas HDi  
r.o.



**8670**  
mgto superior radiador 2.0-16v  
r.o.



## CITROËN XSARA - XSARA PICASSO

 <p><b>3011</b> tapa de termostato 1.4-1.6 hasta '98 r.o. 97523152</p>	 <p><b>3057</b> tubo metálico 1.9 Diesel y TurboD r.o. 1307.W2</p>	 <p><b>3059</b> boquilla en culata Diesel-TD salvo HDi r.o. 0245.42 - 0245.44</p>
 <p><b>3077</b> boquilla en caja termostato 1.8 r.o. 1341.63</p>	 <p><b>3078</b> boquilla en caja termostato 1.8 r.o. 1336.K8</p>	 <p><b>3081</b>                      <b>Ø 15,5 mm</b> boquilla en caja termostato 1.4 r.o. 96064657</p>
 <p><b>3082</b>                      <b>Ø 10 mm</b> boquilla en caja termostato 1.4 r.o. 96064659</p>	 <p><b>3129</b> tubo de agua 1.9 Diesel desde '99 (DW8) r.o. 1307.NY</p>	 <p><b>3135</b> tapa de termostato 2.0 HDi (aluminio) r.o. 1336.P2</p>
 <p><b>3139</b> tubo de agua 2.0 HDi con junta tórica r.o. 1307.YZ</p>	 <p><b>3171</b> boquilla metálica en caja termostato 1.9D-TD r.o. 1336.N7</p>	 <p><b>3503</b> brida conexión manguitos Diesel hasta '98 r.o. 1336.G4</p>
 <p><b>3523</b> brida conexión manguitos 1.8 r.o. 1336.H7 - 1336.J7</p>	 <p><b>3538</b> tapa de termostato 1.8 r.o. 1336.A1</p>	 <p><b>3539</b> tapa de termostato 1.9 Diesel y TurboD r.o. 1336.C9</p>
 <p><b>3544</b> brida conex. mgts 1.9 D desde '99 y 2.0 HDi r.o. 1336.P0 - 1336.Q3</p>	 <p><b>3554</b> brida conexión mgts 2.0 HDi desde '01 r.o.</p>	 <p><b>3548</b> tapón radiador / botella expansión 1.4 bar r.o. 1306.C7 - 1306.84</p>
 <p><b>3555</b> brida conexión mgts. 1.9 DW8 desde '99 r.o. 1336.N8</p>	 <p><b>3556</b> tapa de termostato 2.0 HDi (plástico) r.o. 1336.R9</p>	 <p><b>3560</b> tapón botella expansión 1.4 bar r.o. 1306.C9 - 1306.E4</p>

## CITROËN XSARA - XSARA PICASSO



**3578**  
tapa bomba de agua 1.4 hasta '99  
r.o. 1201.66



**3611**  
tapa con termostato 1.4-1.6 desde '98  
r.o. 1336.Q2



**3631**  
decantador completo con tapón 1.9D-TD  
(motor XUD-XUDTE), r.o.

**¡Nuevo!**



**3637**  
válvula desvaporizadora 1.9D-TD (XUD)  
r.o. 0361.58

**¡Nuevo!**



**3640**  
boquilla en bomba de agua 1.6TU  
r.o. 1201.C3

**¡Nuevo!**



**3641**  
tapa bomba de agua 1.4TU desde '99  
r.o. 1201.C2

**¡Nuevo!**



**3653**  
botella de expansión hasta '01  
r.o. 1307.JF

**¡Nuevo!**



**3658**  
botella de expansión desde '01 con tapón de  
sensor, r.o. 1323.23



**2351**                      **Ø 41 x 47 mm**  
junta de termostato 1.8  
r.o. 1339.53



**2361**                      **Ø 51 x 58 mm**  
junta de termostato Diesel  
r.o. 1339.92



**2113**                      **Ø 33,5 x 3,15 mm**  
junta tórica conector mgto inferior rad.  
(hasta '98) r.o. 1307.V8



**2326**                      **Ø 20 mm**  
tapón obturador salidas brida agua  
r.o. 1355.13

## SUSPENSION DELANTERA y SOPORTES DE MOTOR

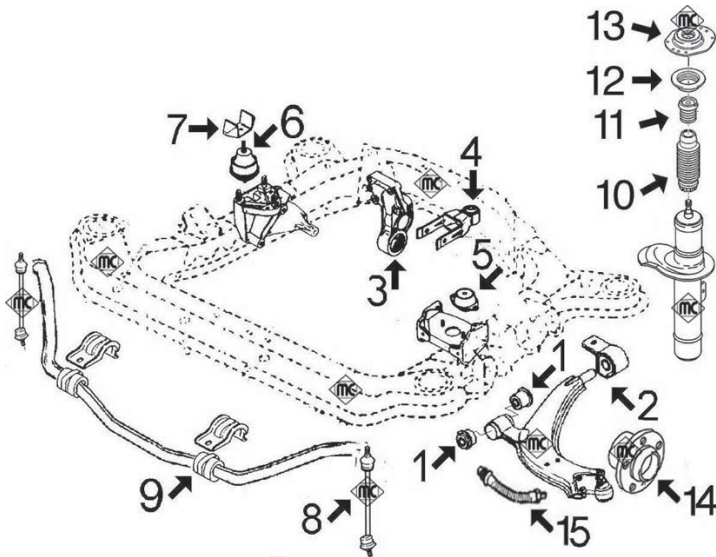

- 1- 962 silentbloc anterior trapecio delantero
- 2- 979 silentbloc posterior trapecio delantero salvo Picasso
- 4063 silentbloc posterior trapecio delantero Picasso
- 3- 751 silentbloc soporte post. motor 1.4-1.6 hasta '98
- 4064 silentbloc soporte post. motor 1.4-1.6 desde '98
- 2980 silentbloc soporte posterior motor 1.8-1.9 Diesel y 2.0 HDi
- 4- 4743 tirante motor trasero completo 1.4-1.6TU
- 4745 tirante motor trasero completo 1.8-1.9D-2.0-2.0HDI (con silentbloc de tornillo de Ø 10 mm)
- 4746 tirante motor trasero completo 1.8-1.9D-2.0-2.0HDI (con silentbloc de tornillo de Ø 12 mm)
- 877 silentbloc tirante posterior de motor 1.4-1.6
- 2871 silentbloc tirante posterior de motor 1.8 y Diesel
- 5- 2786 soporte izquierdo de motor 1.4-1.6
- 2794 soporte izquierdo de motor 1.8-2.0 y Diesel
- 6- 697 soporte derecho motor 1.4-1.6
- 2309 soporte derecho motor 1.8-2.0 y Diesel
- 7- 2884 limitador superior soporte derecho motor hasta '99
- 4058 limitador superior soporte derecho motor desde '99
- 8- 2937 bieleta puntal barra estabilizadora
- 9- 2411 goma barra estabilizadora para barra de Ø 18 mm
- 2412 goma barra estabilizadora para barra de Ø 21 mm
- 2932 goma barra estabilizadora para barra de Ø 22 mm
- 10- 2933 capuchón amortiguador
- 11- 2971 tope poliuretano suspensión delantera
- 12- 4181 rodamiento
- 13- 2935 soporte amortiguador
- 14- 90012 buje rueda delantera
- 15- 96015 latiguillo freno delantero (483 mm)

## BRAZOS SUSPENSION TRASERA

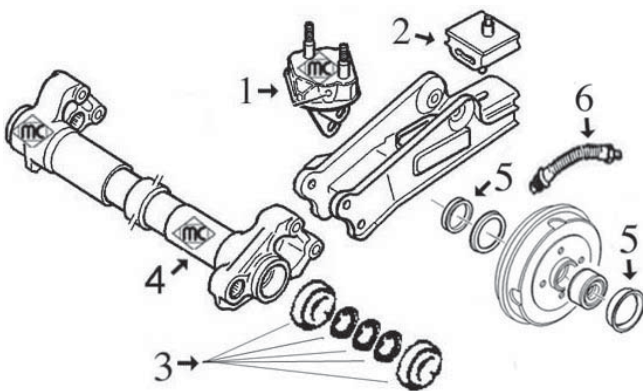

**BERLINA:**

- 1- 2977 soporte anterior brazo trasero derecho
- 2978 soporte anterior brazo trasero izquierdo
- 2- 2694 soporte brazo trasero
- 3- 4413 jgo. reparación brazo trasero con rodamientos
- 4- 4550 eje brazo trasero (derecho e izquierdo)
- 5- 4828 juego tapa y junta tambor trasero
- 6- 96031 latiguillo freno trasero (240 mm)

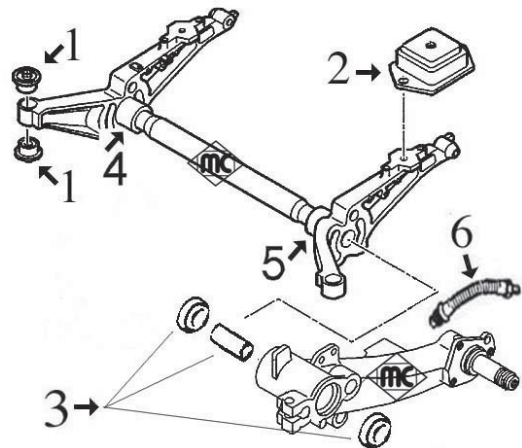

**PICASSO:**

- 1- 4247 silentbloc puente trasero
- 2- 2936 soporte brazo trasero
- 3- 4414 jgo. reparación brazo trasero con rodamientos
- 4- 4552 eje brazo trasero derecho
- 5- 4551 eje brazo trasero izquierdo
- 6- 96031 latiguillo freno trasero (240 mm)

## CITROËN XSARA - XSARA PICASSO

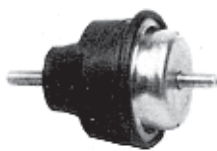

**697** **HIDRAULICO (650 g.)**  
soporte de motor derecho 1.4-1.6  
r.o. 1844.38

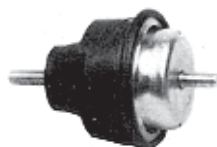

**697/1** **no hidráulico (460 g.)**  
soporte de motor derecho 1.4-1.6  
r.o. ----



**751** **Ø 65 mm**  
silentbloc soporte de motor trasero 1.4-1.6  
hasta '98. r.o. no hay despiece

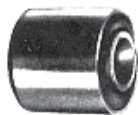

**877**  
silentbloc tirante post. motor 1.1 - 1.4  
r.o. 1809.04 (12x30x28x34)



**962**  
silentbloc anterior trapecio delantero  
r.o. no hay despiece

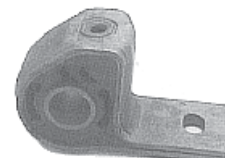

**979**  
silentbloc posterior trapecio delantero  
salvo Picasso, r.o. no hay despiece



**2309** **HIDRAULICO (950 g.)**  
soporte de motor derecho 1.8-2.0 y Diesel  
r.o. 1844.47-1844.73



**2309/1** **no hidráulico (610 g.)**  
soporte de motor derecho 1.8-2.0 y Diesel  
r.o. ----



**2411** **con ánima metálica**  
goma para barra estabilizadora de 18 mm  
r.o. 5094.66



**2412** **con ánima metálica !**  
goma para barra estabilizadora de 21 mm  
r.o. 5094.65



**2694**  
soporte brazo trasero salvo Picasso  
r.o. 5131.71



**2786**  
soporte de motor izquierdo 1.4-1.6  
r.o. 1844.51



**2794**  
soporte de motor izquierdo 1.8-2.0 y Diesel  
r.o. 1844.36



**2871**  
silentbloc tirante posterior motor 1.4-1.6  
r.o. 1809.22 (10x30x28x49)

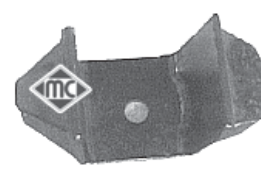

**2884**  
limitador soporte motor derecho hasta '99  
r.o. 1844.25



**2932** **con ánima metálica !**  
goma para barra estabilizadora de 22 mm  
r.o. 5094.77



**2933**  
capuchón amortiguador delantero  
r.o. 5254.13



**2935** **reversible**  
soporte amortiguador delantero **derecho**  
**eizquierdo**, r.o. 5038.24 - 5038.23



**2936**  
soporte posterior puente trasero Picasso  
r.o. 5152.62















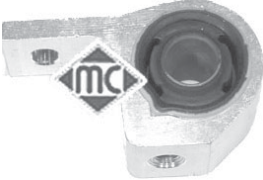



**2937**  
bioleta puntal barra estabilizadora delantera  
r.o. 5087.46



**2971**  
tope suspensión delantera, altura **98 mm**  
r.o. 5033.27 - 5033.51



## CITROËN XSARA - XSARA PICASSO

 <p><b>2977</b> soporte brazo trasero derecho (berlina) r.o. 5131.70-5131.A3</p>	 <p><b>2978</b> soporte brazo trasero izquierdo (berlina) r.o. 5131.69-5131.A2</p>	 <p><b>2980</b> silentbloc soporte de motor tras. 1.8 y D desde '98, r.o. 1809.21</p>
 <p><b>4058</b> limitador soporte motor derecho r.o. 1844.88</p>	 <p><b>4063</b> silentbloc posterior brazo delantero Picasso r.o. 3523.83</p>	 <p><b>4064</b> <span style="float: right;">Ø 65 mm</span> silentbloc soporte de motor tras. 1.1-1.4 desde '98, r.o. no hay despiece</p>
 <p><b>4181</b> rodamiento soporte amortiguador r.o. 5035.27</p>	 <p><b>4247</b> silentbloc puente trasero Picasso r.o. 5131.47</p>	 <p><b>4413</b> jgo. reparación brazo trasero con rodamientos, <b>berlina+break</b>, r.o. 5132.49+5135.45</p>
 <p><b>4414</b> jgo. reparación brazo trasero con rodamientos, <b>Picasso</b>, r.o. 5131.48+5151.49</p>	 <p><b>4550</b> eje brazo trasero <b>berlina+break</b> dcho. e izqd. r.o.</p>	 <p><b>4551</b> eje brazo trasero izquierdo <b>Picasso</b> r.o.</p>
 <p><b>4552</b> eje brazo trasero derecho <b>Picasso</b> r.o.</p>	 <p><b>4743</b> tirante posterior motor completo 1.4-1.6TU r.o.</p>	 <p><b>4745</b> tirante posterior motor completo 1.8-1.9D-2.0-2.0HDI con silentbloc de Ø 10 mm</p>
 <p><b>4746</b> tirante posterior motor completo 1.8-1.9D-2.0-2.0HDI con silentbloc de Ø 12 mm</p>	 <p><b>4828</b> juego tapa y junta tambor trasero r.o. 3724.24+3740.19</p>	 <p><b>90012</b> buje rueda delantera r.o. 3307.72</p>
 <p><b>96015</b> latiguillo freno delantero (483 mm) r.o. 4806.85</p>	 <p><b>96031</b> latiguillo freno trasero (240 mm) r.o. 4806.65-4806.64-4806.65</p>	

ARTICULACIONES PALANCA DE CAMBIO

(salvo "Picasso": cables de mando en lugar de bieletas y articulaciones)

1.4-1.6 (motores TU, cambio MA)

1.8 - 2.0 - Diesel y TurboD (motores XU y DW)  
cambio BE3R (-'01) y BE4R ('01-)

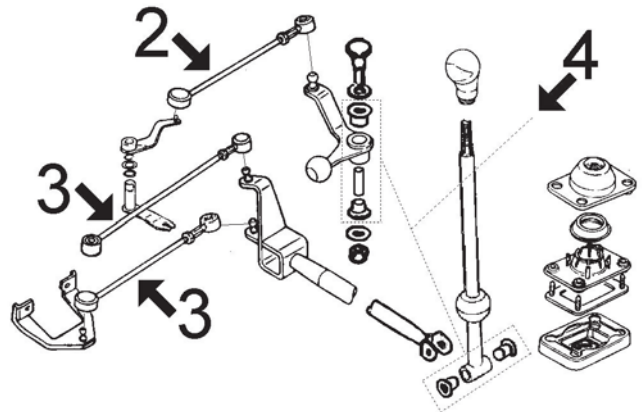
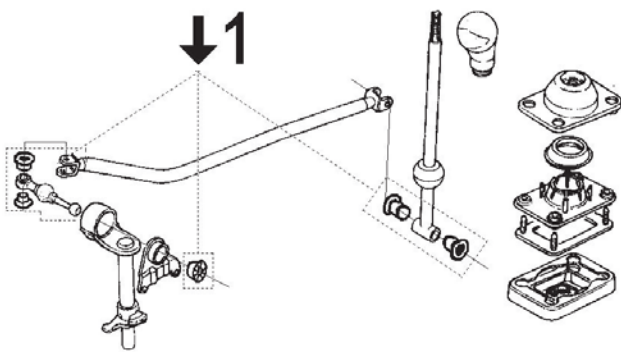









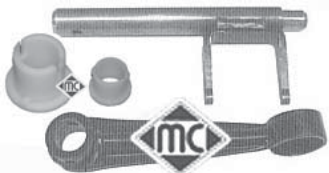





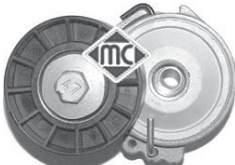





1- 4990 articulación completa con casquillos cambio MA  
2- 2866 bieleta selector velocidades

3- 2865 bieleta selector velocidades  
4- 4992 articulación completa con casquillos cambio BE3R  
5- 4991 articulación completa con casquillos cambio BE4R

<p><b>4990</b> articulación reenvío cambio MA (1.4-1.6TU) completa con casquillos, r.o.</p>	<p><b>4992</b> articulación reenvío cambio BE3R, motores XU hasta '01 completa con casquillos</p>	<p><b>4991</b> articulación reenvío cambio BE4R, motores XU y DW desde '01, completa con casqs.</p>
<p>long. máx 400 mm long. mín 300 mm</p> <p><b>2866</b> bieleta selector velocidades salvo Picasso (rótulas de Ø 13 mm), r.o. 2452.75</p>	<p>long. máx: 135 mm long. mín: 86 mm</p> <p><b>2865</b> bieleta selector velocidades salvo Picasso (rótula de Ø 10 mm), r.o. 2454.E6</p>	<p><b>4057</b> juego casquillos horquilla embreg. 1.4-1.6 r.o.2175.11-2175.12</p>
<p><b>4051</b> juego casquillos horquilla embrague motor XU y DW desde 2/'00, r.o. 2175.54/55</p>	<p><b>4043</b> juego casquillos horquilla embrague motor res XU y DW, r.o. 2175.20-2175.21</p>	<p><b>4052</b> horquilla embrague completa 1.8-1.9-2.0 y 2.0HDi, con casquillos, r.o. 2115.25</p>

## CITROËN XSARA - XSARA PICASSO

 <p><b>4300</b> horquilla embrague completa 1.4-1.6 con casquillos hasta 5/00, r.o. 2117.52</p>	 <p><b>4800</b> horquilla embrague completa 1.4-1.6 con casquillos desde 5/00, r.o. 2117.56</p>	 <p><b>4424</b> altura 55,50 mm casquillo guía embrague cambio MA hasta 5/00, r.o. 2105.14</p>
 <p><b>4796</b> altura 56,50 mm casquillo guía embrague cambio MA desde 5/00, r.o. 2105.38</p>	 <p><b>4605</b> casquillo guía embrague cambio BE4R r.o. 2105.35</p>	 <p><b>4601</b> horquilla embrague 1.4HDi-2.0HDi-1.8EW y 2.0EW, r.o. 2117.66-2117.57</p>
 <p><b>4826</b> tensor correa alternador 1.9D-TD-DW8 r.o. 5751.30</p>	 <p><b>4807</b> tensor correa alternador 2.0HDi r.o. 5751.55</p>	 <p><b>2931</b> tensor correa alternador completo 1.9D-TD r.o. 5751.81</p>
 <p><b>4612</b> varilla nivel aceite 1.9D-TD (XUD) r.o. 1174.15</p>	 <p><b>2335</b> varilla nivel aceite 1.4-1.6TU hasta '01 r.o. 1174.10-1174.49</p>	 <p><b>4593</b> varilla nivel aceite 1.4-TU desde '01 r.o.</p>
 <p><b>4739</b> varilla nivel aceite 1.6TU desde '01 r.o.</p>	 <p><b>4740</b> varilla nivel aceite 1.4HDi r.o.</p>	 <p><b>4596</b> varilla nivel aceite 1.9DW8 hasta '01 r.o.</p>
 <p><b>4597</b> varilla nivel aceite 1.9DW8 desde '01 r.o.</p>	 <p><b>4594</b> varilla nivel aceite 2.0HDi r.o.</p>	 <p><b>3639</b> tapón llenado aceite 1.4TU r.o.</p>
 <p><b>3642</b> tapón llenado aceite 1.9DW8 y 2.0HDi r.o.</p>	 <p><b>3659</b> tapón llenado aceite 1.6/16v-1.8EW-2.0EW r.o.</p>	 <p><b>3651</b> tapa filtro gasoil 1.9DW8 con junta y clip de cierre, r.o. 1904.27+1904.26</p>



# CITROËN XSARA - XSARA PICASSO



**2926**  
polea cigueñal 1.9 Diesel y TurboD (XUD)  
(motores XUD), r.o. 0515.G3



**2927**  
polea cigueñal 1.9 DW8 hasta '02  
(motor DW8), r.o. 0515.Q6



**2928**  
polea cigueñal 2.0 HDi hasta '04  
(motor DW10), r.o. 0515.P2

**¡Nuevo!**



**4441**  
polea cigueñal 1.4 HDi  
r.o. 0515.R0

**¡Nuevo!**



**4477**  
polea cigueñal 2.0 HDi desde '04  
r.o. 0515.S4

**¡Nuevo!**



**4460**  
polea cigueñal 1.6 aire acond.  
r.o. 0515.J3

**¡Nuevo!**



**4481**  
polea cigueñal 1.8/16v-2.0/16v  
r.o. 0515.K6

**¡Nuevo!**



**4443**  
polea cigueñal 2.0/16v  
r.o. 0515.S6-0515.N3

**¡Nuevo!**



**4440**  
polea cigueñal 1.1-1.4 TU  
r.o. 0515.R8-0515.P5

**¡Nuevo!**



**4442**  
polea cigueñal 1.6/16v  
r.o. 0515.S1-0515.P1

**¡Nuevo!**



**4610**  
polea cigueñal 1.9 DW8 desde '02  
r.o. 0515.R5



**¡Nuevo!**



**3697**  
juego tapas correa distribución 1.4 TU  
r.o. 0320.S2+0320.L3

**¡Nuevo!**

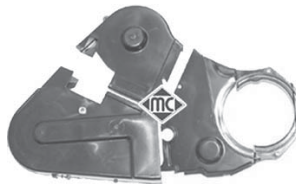

**3698**  
juego tapas correa distribución 1.9 XUD  
r.o. 0320.H2+0320.H3+0320.F9

**¡Nuevo!**



**3700**  
juego tapas correa distribución 1.9 DW8  
r.o. 0320.N3+0320.X6+0320.N4

**¡Nuevo!**



**3699**  
juego tapas correa distribución 2.0 HDi  
r.o. 0320.N5+0320.N6+0320.S7

**¡Nuevo!**



**4915** Ø 54,60 mm  
polea de alternador de rueda libre  
r.o.

**¡Nuevo!**



**4916** Ø 58,50 mm  
polea de alternador de rueda libre  
r.o.

**¡Nuevo!**



**4928** Ø 10-60 / 25 mm  
rodillo tensor correa alternador XUD-1.9 DW  
sin A/C, r.o. 5751.73

**¡Nuevo!**



**4995**  
rodillo tensor correa alternador 1.9 DW8 y  
2.0 HDi con A/C, r.o. 5751.29

**¡Nuevo!**



**4996**  
rodillo tensor correa alternador 2.0 HDi sin  
A/C, r.o. 5751.96-5751.57



## CITROËN XSARA - XSARA PICASSO

<p><b>4929</b> <span style="float: right;">Ø 17-90 / 25 mm</span> rodillo tensor correa alternador 1.8-2.0 r.o.5751.20</p>	<p><b>4895</b> tensor correa alternador 1.8-2.0 r.o.5751.35</p>	<p><b>5043</b> tensor correa alternador 1.9DW8 r.o.5751.74</p>
<p><b>1536</b> fuelle derecho cremallera r.o.4066.22</p>	<p><b>1268</b> fuelle izquierdo cremallera salvo Picasso r.o.</p>	<p><b>1740</b> fuelle izquierdo cremallera Picasso r.o.</p>
<p><b>844</b> capuchón derecho cremallera r.o.4066.16.</p>	<p><b>2410</b> silentbloc pistón cremallera asistida berlina r.o.4059.07 (12x22x20x24)</p>	<p><b>2911</b> silentbloc pistón cremallera asist. Picasso r.o.4059.10(12x24x20x24)</p>
<p><b>1222</b> kit rep. transmisión l/rueda 1.8-2.0-D-TD y 1.4-1.6Picasso,r.o.3293.03</p>	<p><b>1213</b> kit rep. transmisión l/cambio 1.8-2.0-D-TD r.o.3287.81</p>	<p><b>1427</b> kit rep. transmisión l/rueda 1.4-1.6 berlina desde '99,r.o. 3293.20</p>
<p><b>1428</b> kit rep. transmisión l/cambio 1.4-1.6 desde '99 r.o.3287.88</p>	<p><b>1460</b> kit rep. transmisión l/rueda 1.9 D desde '99 r.o.3293.02</p>	<p><b>1521</b> kit rep. transmisión l/rueda 1.4-1.6 hasta '99 r.o.3293.05</p>
<p><b>1533</b> kit rep. transmisión l/cambio 1.4-1.6 hasta '99 r.o.</p>	<p><b>4564</b> <span style="float: right;">Ø 30/47 y 40/58 mm</span> juego retenes diferencial-transmisión r.o.3121.44+3121.46</p>	<p><b>4479</b> juego soporte tapa motor 2.0HDi r.o.0137.11+0137.23</p>
<p><b>016</b> tapón cierre inyectores Diesel r.o.</p>	<p><b>4060</b> soporte tubo de escape todos salvo HDi r.o.1755.77</p>	<p><b>4061</b> soporte tubo de escape Diesel-break r.o.1755.86</p>

## CITROËN XSARA - XSARA PICASSO



**4059**  
soporte tubo de escape 2.0 HDi  
r.o. 1755.91



**2941**                    **junta de Ø 60 x 46 mm**  
kit montaje colector 1.9D hasta '99  
y 1.8-2.0 gasolina desde '99, r.o.



**2938**                    **junta de Ø 58 x 45 mm**  
kit montaje colector 1.9 Diesel desde '98  
(motor DW8), r.o.



**2939**  
kit montaje colector 2.0 HDi  
r.o. 1797.18



**2940**  
kit montaje colector 1.8-2.0 gasolina hasta  
'99, r.o. 1798.80-1798.75



**4039**  
kit montaje colector 1.9 TurboD hasta '00  
r.o. 1798.74



**942**  
funda protectora Delco  
r.o. 5966.16



**4036**  
bomba manual cebado gasoil con válvula  
antirretorno y boquilla adicional a 90°



**2770**  
cubrepedal de freno  
r.o. 4504.12



**2771**  
cubrepedal embrague  
r.o. 2130.13



**2772**  
cubrepedal acelerador  
r.o. 1604.07



**2452**  
tapón cárter aceite rosca 14x125  
r.o. 0311.21



**2929**  
tapón cárter aceite 10x125 1.9D (DW8)  
r.o. 0311.29



**2050**  
arandela metaloplástica 14x22 (HDi)  
r.o. 0313.27



**2051**  
arandela plana tapón cárter 10x21 mm  
r.o. 0313.33



**2024**  
arandela tapón cárter con junta de goma  
14mm, r.o.

## CANALIZACIONES DE AGUA

ZX 1.4 motor TU (motores TU3 de carburador y TU5 de inyección):

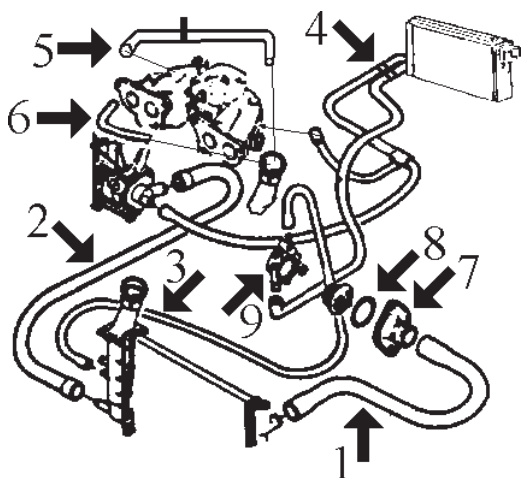

- 1- 8266 mgto superior radiador sin aire acond.  
8298 mgto superior radiador con aire acond.
- 2- 8265 mgto inferior radiador
- 2113 junta tórica conector rápido mgto inferior
- 3- n/d mgto de radiador a caja termostato, sólo versiones con aire acond.
- 4- 8299 mgto doble de calefactor 1.4 carburador (TU3)  
8300 mgto doble de calefactor 1.4 inyección (TU5)
- 5- n/d mgto de colector a bomba de agua
- 6- n/d mgto de colector a caja repartidora
- 7- 3011 tapa de termostato
- 8- 2351 junta de termostato
- 9- 3081 boquilla metálica caja termostato Ø 16 mm  
3082 boquilla metálica caja termostato Ø 10 mm

mgto desvaporizadores: MC-8167 y MC-8002

ZX 1.6i hasta '93 (motor XU5M) y 1.6i desde '93 (motor XU5JP)  
ZX 1.9i hasta '93 (motor XU9JA) y 1.8i desde '93 (motor XU7JP)  
ZX 2.0i desde '93 (motor XU10J2C)

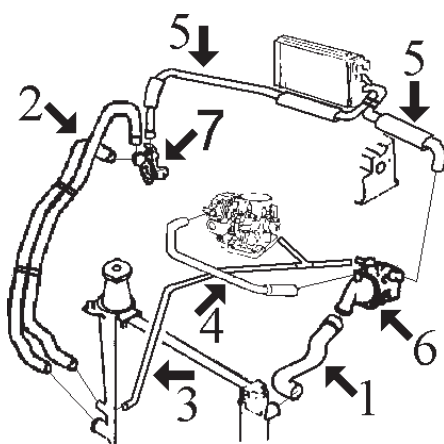

- 1- 8267 mgto superior radiador 1.6 y 1.9 hasta '93  
8295 mgto superior radiador 1.6-1.8 y 2.0 desde '93
- 2- 8230 mgto inferior radiador 1.6 y 1.9 hasta '93  
8292 mgto inferior radiador 1.6-1.8-2.0 de '93 a '96  
8294 mgto inferior radiador desde '96 (grapas perpendiculares al plano del tubo)  
8998 mgto inferior radiador desde '96 (grapas horizontales al plano del tubo)
- 2113 junta tórica conector rápido mgto inferior
- 3- 8310 mgto de radiador a caja termostato 1.6 hasta '93  
8311 mgto de radiador a caja termostato 1.9 hasta '93  
8306 mgto de radiador a caja termostato 1.6, 1.8 y 2.0 desde '93
- 4- 7877 mgto de caja mariposa a termostato 1.9 hasta '93
- 5- 8301 mgto doble de calefactor todos mods.
- 6- 3551 tapa de termostato 1.6-1.9 hasta '93  
3538 tapa de termostato 1.6-1.8-2.0 desde '93  
2351 junta de termostato Ø 41x47  
3077 boquilla metálica en caja termostato Ø 19 mm  
3078 boquilla metálica en caja termostato Ø 10 mm
- 7- 3523 brida agua conexión mgto



MGTO DESVAPORIZADORES 1.6i (motor XU5M) y 1.9i (motor XU9JA):

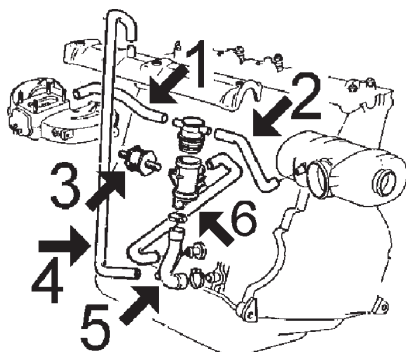

- 1- 8320 mgto de tapón llenado a colector
- 2- 8305 mgto de tapón llenado a filtro de aire
- 3- 4490 soporte elástico decantador
- 4- 8304 mgto de tapa balancines a cárter 1.6-1.9  
8854 mgto doble de tapa a cárter 1.8i
- 5- 8187 mgto de decantador a cárter (3 vías)
- 6- 8309 mgto de decantador a cárter motor

mgto desvaporizadores motores XU5JP y XU7JP, no disponibles

**ZX Diesel (motor XUD9A) desde '91 y  
ZX TurboDiesel (motor XUD9TE) desde '91 hasta '94 (-PR6170)**

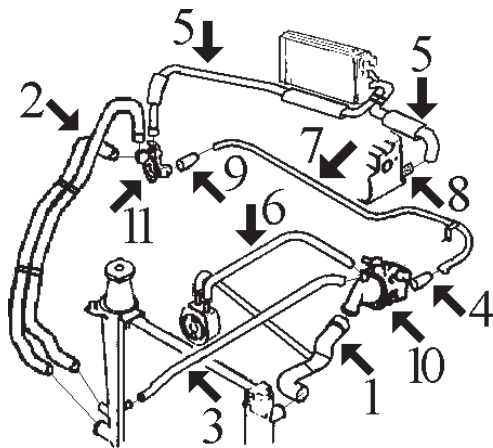

- 1- 8268 mgto superior radiador Diesel y TD
- 2- 8230 mgto inferior radiador Diesel hasta '94
- 8294 mgto inferior radiador desde '95 (grapas perpendiculares al plano del tubo)
- 8998 mgto inferior radiador desde '95 (grapas horizontales al plano del tubo)
- 2113 junta tórica conector rápido mgto inferior
- 3- 8311 mgto degasificador Diesel hasta '94 (PR6170)
- 8306 mgto degasificador Diesel desde '94 (PR-6171)
- 8321 mgto degasificador TurboDiesel
- 4- 8183 mgto de caja termostato a tubo metálico
- 5- 8303 mgto doble de calefactor D y TD
- 6- 8313 mgto de intercambiador a caja termostato D-TD
- 7- 3057 tubo metálico
- 8- 3059 boquilla en culata
- 9- 8312 mgto de tubo metálico a caja entrada
- 10- 3539 tapa de termostato
- 2361 junta de termostato 51x58 mm
- 3171 boquilla en caja termostato
- 11- 3503 brida agua conexión mgtos

**ZX TurboDiesel (motor XUD9TE) desde '94 (desde PR-6171):**

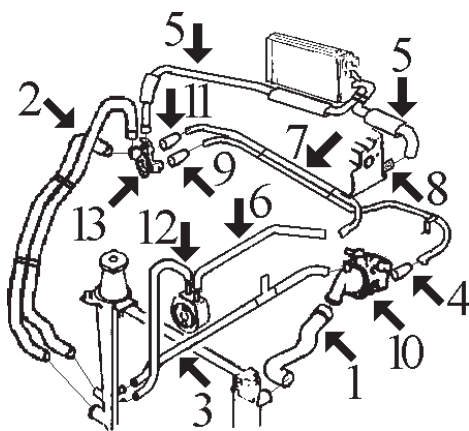

- 1- 8297 mgto superior radiador
- 2- 8294 mgto inferior radiador
- 2113 junta tórica conector rápido mgto inferior
- 3- 8321 mgto degasificador de radiador a caja termostato (tramo de 3ª vía a culata, cortar de rollo MC-115 6x14 mm, longitud 500 mm)
- 4- 8183 mgto de caja termostato a tubo metálico
- 5- 8303 mgto doble de calefactor
- 6- 8314 mgto de intercambiador a tubo metálico
- 7- n/d tubo metálico
- 8- 3059 boquilla en culata
- 9- 8316 mgto de tubo metálico a caja entrada
- 10- 3539 tapa de termostato
- 2361 junta de termostato 51x58 mm
- 3171 boquilla en caja termostato
- 11- 8312 mgto de tubo metálico a caja entrada
- 12- 8315 mgto de radiador a intercambiador
- 13- 3503 brida agua conexión mgtos























**MGTOS DESVAPORIZADORES Diesel y TurboDiesel:**



- 1- 8307 mgto de decantador a tapa de balancines D y TD
- 2- 8167 mgto de decantador a filtro de aire Diesel
- 8308 mgto de decantador a filtro de aire TurboDiesel
- 3- 8166 mgto de decantador a cárter motor
- 4- 3631 decantador completo con tapón 1.9D-TD



## CITROËN ZX

 <p><b>7877</b> mgto de caja mariposa a termostato 1.9 -'93 r.o. 1415.A1</p>	 <p><b>8002</b> mgto desvaporizador 1.4 r.o. 1191.20</p>	 <p><b>8166</b> mgto desvaporizador Diesel y TurboD r.o. 1192.48</p>
 <p><b>8167</b> mgto desvaporizador Diesel r.o. 1180.A3</p>	 <p><b>8183</b> mgto de termostato a tubo metálico D y TD r.o. 1307.W3</p>	 <p><b>8187</b> mgto desvaporizador 1.6-1.9 r.o. 1180.25</p>
 <p><b>8230</b> mgto inferior radiador 1.6-1.9 y D hasta '93 r.o. 95667383</p>	 <p><b>8265</b> mgto inferior radiador 1.4 r.o. 1351.J4</p>	 <p><b>8266</b> mgto sup radiador 1.4 sin aire acond. r.o. 1343.J2</p>
 <p><b>8267</b> mgto sup radiador 1.6-1.9 hasta '93 r.o. 96050236</p>	 <p><b>8268</b> mgto sup radiador Diesel y TD (hasta '94) r.o. 1343.V5</p>	 <p><b>8292</b> mgto inf radiador 1.6-1.8-2.0 de '93 a '96 y 16 v., r.o. 1351.H8</p>
 <p><b>8294</b> mgto inferior radiador Diesel -TD d/ '95 (grapas perpendiculares al plano del tubo)</p>	 <p><b>8295</b> mgto sup radiador 1.6-1.8-2.0 desde '93 r.o. 1343.H7</p>	 <p><b>8297</b> mgto sup radiador TurboD desde '94 r.o. 1343.K2</p>
 <p><b>8298</b> mgto sup radiador 1.4 con aire acond. r.o. 1343.J2</p>	 <p><b>8299</b> mgto doble de calefactor 1.4 carburador r.o. 96050226</p>	 <p><b>8300</b> mgto doble de calefactor 1.4 inyección r.o. 6464.S3</p>
 <p><b>8301</b> mgto doble de calefactor 1.6-1.8-1.9-2.0 r.o. 1351.Q1</p>	 <p><b>8303</b> mgto doble de calefactor Diesel y TurboD r.o. 6464.NG</p>	 <p><b>8304</b> mgto desvaporizador 1.6 y 1.9 r.o. 96099647</p>

## CITROËN ZX



**8305**  
mgto desvaporizador 1.6-1.9  
r.o. 96096800



**8306**  
mgto de radiador a termostato 1.6-1.8-2.0  
r.o. 1351.M2



**8307**  
mgto desvaporizador Diesel y TurboD  
r.o. 1180.86



**8308**  
mgto desvaporizador TurboDiesel  
r.o. 1180.A5



**8309**  
mgto desvaporizador 1.6-1.9  
r.o. 96100920

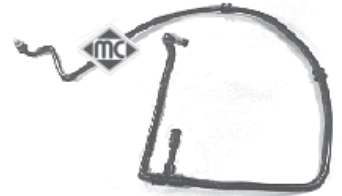

**8310**  
mgto de radiador a termostato 1.6 -'93  
r.o. 96050241



**8311**  
mgto de radiador a termostato 1.9 y D -'93  
r.o. 96050266



**8312**  
mgto de tubo metálico a caja agua D y TD  
r.o. 1307.W4



**8313**  
mgto de intercambiador a termost. D y TD  
r.o. 1307.AA



**8314**  
mgto de intercambiador a tubo TurboDiesel  
r.o. 1307.JC



**8315**  
mgto de radiador a intercambiador TurboD  
r.o. 1307.Y2



**8316**  
mgto de tubo metálico a caja de agua TD  
r.o. 1307.X9



**8320**  
mgto desvaporizador 1.6-1.9  
r.o. 96084132



**8321**  
mgto de radiador a termostato TurboDiesel  
r.o. 1351.M3



**8854**  
mgto desvaporizador 1.8 gasolina (XU7)  
r.o. 1180.62

**¡Nuevo!**

**¡Nuevo!**



**8998**  
mgto inf radiador 1.9D/TD (grapas  
horizontales al plano del tubo)



**3011**  
tapa de termostato 1.4  
r.o. 97523152



**3057**  
tubo metálico Diesel  
r.o. 1307.W2



**3059**  
boquilla en culata Diesel y TurboD  
r.o. 0245.42-0245.44

## CITROËN ZX

 <p><b>3077</b> <span style="float: right;"><b>Ø 19 mm</b></span> boquilla en caja termostato 1.6-1.8-1.9-2.0 r.o. 1341.63</p>	 <p><b>3078</b> boquilla en caja termostato 1.6-1.8-1.9-2.0 r.o. 1336.K8</p>	 <p><b>3081</b> <span style="float: right;"><b>Ø 15,5 mm</b></span> boquilla en caja termostato 1.4 r.o. 96064657</p>
 <p><b>3082</b> boquilla en caja termostato 1.4 r.o. 96064659</p>	 <p><b>3171</b> boquilla en caja termostato 1.9D-TD r.o. 1336.N7</p>	 <p><b>4490</b> soporte decantador vapores aceite r.o. 1439.10</p>
 <p><b>3503</b> <span style="float: right;"><b>con junta tórica</b></span> brida agua conexión mgts Diesel y TD r.o. 1336.G4+1340.28</p>	 <p><b>3523</b> <span style="float: right;"><b>órica</b></span> brida agua conexión mgts todos gasolina. salvo 16v, r.o. 1336.H7 - 1336.J7+1339.79</p>	 <p><b>3538</b> tapa de termostato 1.6-1.8-2.0 gasolina desde '93, r.o. 1336.A1</p>
 <p><b>3539</b> tapa de termostato Diesel y TurboD r.o. 1336.C9</p>	 <p><b>2351</b> <span style="float: right;"><b>Ø 41 x 47</b></span> junta de termostato motor XU r.o. 1339.53</p>	 <p><b>2361</b> <span style="float: right;"><b>Ø 51 x 58</b></span> junta de termostato Diesel r.o. 1339.92</p>
 <p><b>2326</b> <span style="float: right;"><b>Ø 20 mm</b></span> tapón obturador salidas brida agua r.o.</p>	 <p><b>2113</b> <span style="float: right;"><b>Ø 33,5 x 3,15 mm</b></span> junta tórica conector mgto inferior radiador r.o. 1307.V8</p>	 <p><b>3578</b> tapa bomba de agua 1.4 r.o. 1201.66</p>
 <p><b>3551</b> tapa de termostato 1.6-1.9 gasolina hasta '93 r.o. 1336.88</p>	 <p><b>3608</b> tapón de radiador (metálico) 1.2 bar r.o. 1306.85</p>	 <p><b>3548</b> tapón de radiador (plástico) 1.4 bar r.o. 1306.C7 - 1306.84</p>
 <p><b>3631</b> decantador completo con tapón 1.9D-TD r.o. 1180.95</p>		

## SUSPENSION DELANTERA y SOPORTES DE MOTOR todos modelos:

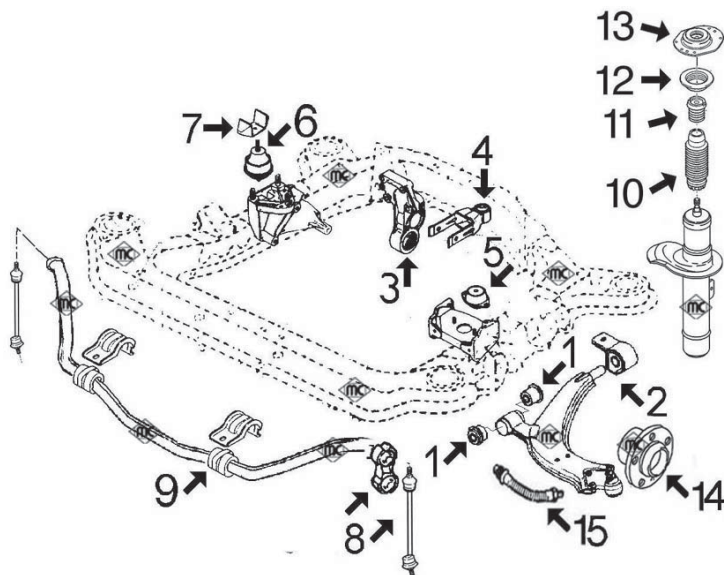

- 1- 962 silentbloc anterior trapecio delantero
- 2- 979 silentbloc posterior trapecio delantero
- 3- 2869 silentbloc de soporte motor trasero 1.6 - 1.8 - 1.9 2.0 - 16 v. - Diesel y TurboD
- 751 silentbloc de soporte de motor trasero 1.4
- 4- 4743 tirante motor trasero completo 1.4 TU
- 4745 tirante motor trasero completo 1.8i-1.9D-TD
- 4744 tirante motor trasero completo 1.6-1.9 gasolina XU
- 877 silentbloc tirante de motor trasero 1.4-1.6-1.9
- 2871 silentbloc tirante de motor trasero 1.8 - 2.0 y D
- 5- 531 soporte de motor izquierdo 1.6-1.9 hasta '93
- 2786 soporte de motor izquierdo 1.4
- 2794 soporte de motor izqdo. 1.6 desde '93- 1.8 - 2.0 Diesel, Turbodiesel y cambios automáticos
- 6- 697 soporte de motor derecho 1.4-1.6-1.8-1.9 salvo cambios automáticos (hidráulico)
- 2309 soporte de motor derecho 2.0 - Diesel - TurboD - 16v. y cambios automáticos
- 7- 2884 limitador de soporte de motor derecho
- 8- 2693 bieleta puntal barra estabilizadora hasta '94
- 2937 bieleta puntal barra estabilizadora desde '94
- 9- 2411 goma barra estabilizadora Ø 18 mm
- 2412 goma barra estabilizadora Ø 21 mm
- 2691 goma barra estabilizadora Ø 24 mm
- 10- 2933 capuchón amortiguador
- 11- 2971 tope poliuretano altura 95 mm (break)
- 2975 tope poliuretano altura 78 mm
- 12- 4181 rodamiento soporte amortiguador
- 13- 2935 soporte amortiguador dcho. e izqdo. (reversible)
- 14- 90013 buje rueda delantera 1.4 sin ABS (21 estrías)
- 90012 buje rueda delantera 1.4 con ABS, 1.6-1.9, D y TD (25 estrías)



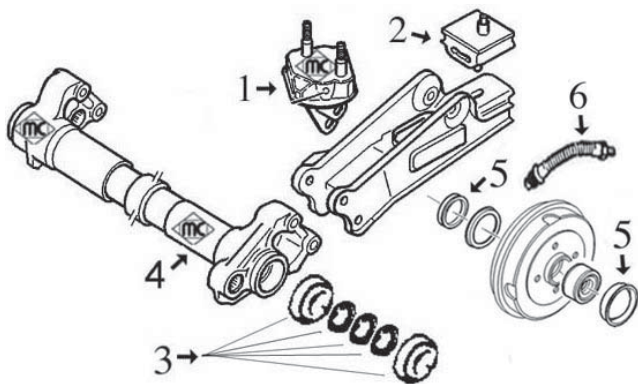









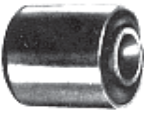

## BRAZO SUSPENSION TRASERA



- 1- 2978 soporte anterior brazo trasero izquierdo
- 2977 soporte anterior brazo trasero derecho
- 2- 2694 soporte posterior brazo trasero
- 3- 4413 jgo.reparación brazo trasero completo con con rodamientos
- 4- 4550 eje brazo (derecho e izquierdo)
- 5- 4828 juego retén eje trasero y tapón tambor
- 6- 96031 latiguillo freno trasero berlina (265 mm)
- 96044 latiguillo freno trasero familiar (177 mm)



## CITROËN ZX

 <p><b>531</b> soporte de motor izquierdo 1.6-1.9 hasta '93 r.o. 1843.95</p>	 <p><b>2869</b>      <b>Ø 70 mm</b> silentbloc soporte de motor trasero todos ex- cepto 1.4, r.o. 1809.17 - 1809.21</p>	 <p><b>697</b>      <b>HIDRAULICO (650 g.)</b> soporte de motor dcho. 1.4-1.8-1.9 salvo automáticos, r.o. 1844.42</p>
 <p><b>2884</b> limitador de soporte de motor derecho r.o. 1844.25</p>	 <p><b>751</b>      <b>Ø 65 mm</b> silentbloc soporte de motor trasero 1.4 r.o.</p>	 <p><b>877</b> silentbloc tirante de motor trasero 1.4-1.6 y 1.9 gasolina, r.o. 1809.04</p>
 <p><b>962</b> silentbloc anterior trapecio delantero r.o. 96011483</p>	 <p><b>979</b> silentbloc posterior trapecio delantero r.o. 96097927 - 3523.75</p>	 <p><b>2309</b>      <b>HIDRAULICO (950 g.)</b> soporte de motor dcho Diesel-TD-2.0-16v. y automáticos, r.o. 1844.47-96171996</p>
 <p><b>2411</b>      <b>con ánima metálica</b> goma para barra estabilizadora de Ø 18 mm r.o. 96158745</p>	 <p><b>2412</b>      <b>con ánima metálica</b> goma para barra estabilizadora de Ø 21 mm r.o. 5094.65</p>	 <p><b>2691</b>      <b>con ánima metálica</b> goma para barra estabiliz. de Ø 24 mm r.o. 96051398</p>
 <p><b>2693</b> bieleta puntal barra estabilizadora hasta '94 r.o. 96052007</p>	 <p><b>2694</b> soporte brazo de suspensión trasero r.o. 5131.71</p>	 <p><b>2786</b> soporte de motor izquierdo 1.4 r.o. 96104506</p>
 <p><b>2794</b> soporte motor izquierdo 1.6 desde '93, 1.8 2.0-16v-Diesel y TurboD, r.o. 1827.10</p>	 <p><b>2871</b> silentbloc tirante de motor trasero 1.8 - 2.0 y Diesel (10x30x28x50), r.o. 1809.22</p>	 <p><b>4181</b> rodamiento soporte amortiguador r.o. 5035.27</p>
 <p><b>2937</b> bieleta puntal barra estabilizadora r.o. 5087.46</p>	 <p><b>2938</b> soporte amortiguador delantero dcho+izqd. r.o. 5038.23-5038.24-5038.21</p>	 <p><b>2971</b> tope amortiguador delantero (altura 95mm) r.o. 5033.27</p>

## CITROËN ZX



**2975**  
tope poliuretano suspensión delantera  
r.o.5033.26



**2977**  
soporte anterior brazo trasero **derecho**  
r.o.5131.70-5131.A2



**2978**  
soporte anterior brazo trasero **izquierdo**  
r.o.5131.69-5131.A3



**4413**  
jgo. reparación brazo suspensión trasero  
r.o.5132.49+5135.45



**2933**  
capuchón amortiguador delantero  
r.o.5254.18



**4550**  
eje brazo trasero (derecho e izquierdo)  
r.o. //(no existe suelto en origen)



**4743**  
tirante trasero de motor completo 1.4 TU  
r.o.



**4744**  
tirante trasero de motor completo 1.6-1.9 car-  
burador, r.o.



**4745**  
tirante tras. de motor completo 1.8i-1.9D-  
1.9TD, r.o.



**4828**  
juego retén eje trasero y tapón tambor  
r.o.3724.24+3740.19



**90013** 21 estrías  
bujе rueda delantera 1.4 sin ABS  
r.o.3307.49



**90012** 25 estrías  
bujе rueda delantera 1.4 con ABS, 1.6, 1.9  
D y TD, r.o.3307.72



**96140**  
latiguillo freno delantero (460 mm)  
r.o.96124230



**96031**  
latiguillo freno trasero berlina (265 mm)  
r.o.4806.64-4806.65



**96044**  
latiguillo freno trasero familiar (177 mm)  
r.o.4806.52

## ARTICULACIONES PALANCA DE CAMBIO:

motor 1.4TU:  
(cambio MA)

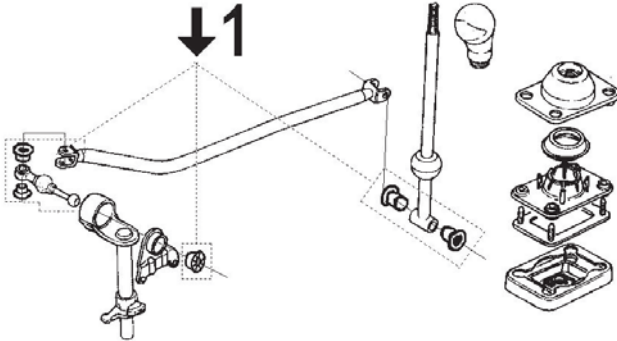



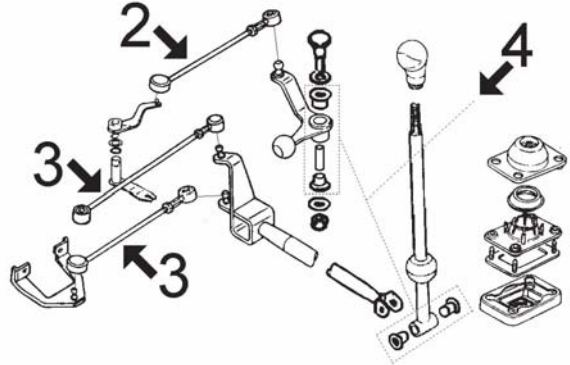





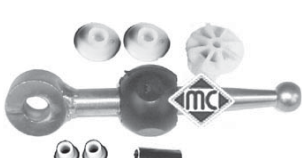

motores 1.6 - 1.8 - 1.9 D/TD - 2.0 y 16 v.:  
(cambio BE3R)

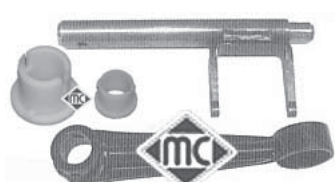

1- 4993 articulación reenvío y jgo casquillos completo  
2- 2348 bieleta selector velocidades 1.6-1.9-2.0 y 16v.

3- 2865 bieleta selector velocidades 1.6-1.9-2.0 y 16v.  
4- 4992 articulación reenvío y jgo casquillos completo











<p><b>¡Nuevo!</b></p>  <p><b>4993</b> articulación reenvío con juego de casquillos completo, cambio MA (motores TU)</p>	<p><b>¡Nuevo!</b></p>  <p><b>4992</b> articulación reenvío con juego de casquillos completo, cambio BE3R (motores XU)</p>	 <p><b>2348</b> bieleta selector velocidades 1.6-1.9-2.0 (rótulas de Ø 13 mm), r.o. 96110640</p>
<p>long. máx: 135 mm long. mín: 86 mm</p>  <p><b>2865</b> bieleta selector velocidades 1.6-1.9-2.0 (rótula de Ø 10 mm), r.o. 2454.E6</p>	 <p><b>2335</b> varilla nivel aceite 1.4 r.o. 1174.10</p>	<p><b>¡Nuevo!</b></p>  <p><b>4612</b> varilla nivel aceite 1.9D-TD r.o. 1174.15</p>
<p><b>¡Nuevo!</b></p>  <p><b>4672</b> varilla nivel aceite 1.6-1.9 xu gasolina r.o. 1172.79</p>	 <p><b>4300</b> horquilla embrague completa motor TU con casquillos, r.o. 2117.52</p>	 <p><b>4057</b> jgo casquillos horquilla embrague mot TU r.o. 2175.11+2175.12</p>
 <p><b>4052</b> horquilla embrague compl. motor XU-XUD con casquillos, r.o. 2115.25</p>	 <p><b>4043</b> jgto casqs. horquilla embrg motor XU-XUD r.o. 2175.20+2175.21</p>	<p><b>¡Nuevo!</b></p>  <p><b>4424</b> casquillo guía embrgue 1.4TU-cambio MA r.o. 2105.14</p>

# CITROËN ZX

<p><b>¡Nuevo!</b></p>  <p><b>4605</b> casquillo guía embrague cambio BE4R r.o.2105.35</p>	 <p><b>3639</b> tapón llenado aceite 1.4TU r.o.0258.55</p>	<p><b>¡Nuevo!</b></p>  <p><b>4564</b>      Ø 30/47 y 40/58 mm juego retenes diferencial-transmisión r.o.3121.44+3121.46</p>
<p><b>¡Nuevo!</b></p>  <p><b>3697</b> juego tapas correa distribución 1.4TU r.o.0320.S2+0320.L3</p>	<p><b>¡Nuevo!</b></p>  <p><b>3698</b> juego tapas correa distribución 1.9D-TD r.o.0320.H2+0320.H3+0320.F9</p>	 <p><b>268</b> fuelle cremallera dirección, dcho+izqd manual, izqdo. asistida, r.o. 91510293</p>
 <p><b>287</b> juego casquillos cremallera manual r.o.7910033422+91506517+7903053527</p>	 <p><b>1845</b> fuelle derecho cremallera asistida r.o.4066.28</p>	 <p><b>844</b> capuchón derecho cremallera asitida r.o.4066.16</p>
 <p><b>2410</b> silentbloc pistón cremallera asistida r.o.96044954-4059.07 (12x22x20x24)</p>	 <p><b>1710E</b> kit rep. transm. l/rda <b>para montar en cono</b> en neopreno especial de elasticidad 800%</p>	 <p><b>1710</b> kit rep. transmisión l/rueda 1.4 r.o.3293.77</p>
 <p><b>1493E</b> kit rep transm l/rda. <b>para montar en cono</b> en neopreno especial de elasticidad 800%</p>	 <p><b>1493</b> kit rep. transm. l/rueda 1.6-1.9 D hasta '93 (hasta PR-5008), r.o. 96009166 - 3293.83</p>	 <p><b>2305</b> kit rep. transm. l/rueda 1.6-1.9D desde '95 (desde PR-5009), r.o. 3293.96</p>
 <p><b>1708E</b> kit rep. transm l/rda <b>para montar con cono</b> en neopreno especial de elasticidad 800%</p>	 <p><b>1708</b> kit rep. transm. l/rueda 2.0-16v y TurboD r.o.95644369 - 3293.80</p>	 <p><b>1222</b> kit rep. transm. l/rueda 1.6-1.8-2.0 d/'94 r.o.3293.03</p>
 <p><b>1533</b> kit rep. transm. l/cambio 1.4 (cárter de 87 mm, Ø 78 mm), r.o. 3287.69</p>	 <p><b>1362</b> kit rep. transm. l/cambio 1.6-1.9-D-TDh'93 r.o. 3293.59</p>	 <p><b>1213</b> kit rep. transm. l/cambio 1.6-1.8-2.0 d/'94 r.o.3287.71</p>



## CITROËN ZX

 <p><b>1839</b> kit rep transm l/cbo 1.6-1.9D-TD desde '93 r.o.3287.76-3287.79</p>	 <p><b>2931</b> tensor correa alternador 1.9D-TD r.o.5751.81</p>	 <p><b>4609</b> tensor correa alternador 1.9D-TD sin A/C r.o.5751.38</p>
 <p><b>4826</b> tensor correa alternador 1.9D-TD con A/C r.o.96230012</p>	 <p><b>4929</b> rodillo tensor correa alternador 1.6-1.8/16v r.o.5751.20</p>	 <p><b>4895</b> tensor correa alternador 1.6-1.8/16v r.o.5751.35</p>
 <p><b>2926</b> polea cigüeñal 19D-TD r.o.0515.G3</p>	 <p><b>4485</b> polea cigüeñal 1.8i (XU7) r.o.0515.H6</p>	 <p><b>2393</b> junta cónica tubo de escape Ø 46.2 mm r.o.95602682</p>
 <p><b>2392</b> kit montaje tubo escape (junta de Ø 46.2) r.o.</p>	 <p><b>088</b> soporte tubo de escape r.o.96125080</p>	 <p><b>084</b> soporte tubo de escape r.o.96037651</p>
 <p><b>2770</b> cubrepedal freno r.o.4504.12</p>	 <p><b>2771</b> cubrepedal embrague r.o.2130.13</p>	 <p><b>2772</b> cubrepedal acelerador r.o.1604.07</p>
 <p><b>2024</b> arandela tapón de cárter Ø 14 mm con retén de goma, r.o.</p>	 <p><b>2025</b> arandela tapón de cárter Ø 16 mm con retén de goma, r.o.97532428</p>	 <p><b>0667</b> tapón de cárter 16x150 r.o.0163.70</p>
 <p><b>2452</b> tapón de cárter 14x125 r.o.0311.21</p>	 <p><b>2434</b> bioleta sujeción cable embrague a pedal r.o.96074781</p>	 <p><b>4036</b> bomba cebado manual Diesel con válvula antirretorno y boquilla adicional a 90°</p>

## FIAT BRAVO-BRAVA-MAREA



**2344**  
soporte motor trasero 1.4-1.6-Diesel hasta '98, r.o.

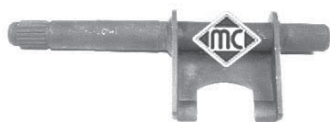

**4268**  
horquilla embrague 1.6 r.o. 7617578



**4011**  
casquillo plástico reenvío mando cambio r.o. 4259848



**4206**  
rodamiento soporte amortiguador delantero r.o. 1303672080



**2345**  
capuchón amortiguador delantero r.o. 7607086



**1996**  
kit fuelle transmisión l/rueda salvo 2.0 r.o.



**1115**  
kit fuelle transmisión l/rueda 2.0 r.o.



**583**  
fuelle transmisión lado cambio 1.4-1.6 sin rodamiento, r.o.



**1583**  
kit fuelle transm. l/cambio 1.4-1.6 hasta '96 completo con rodamiento Ø 23,0 r.o. 7625541



**1120**  
kit fuelle transm. l/cambio 1.4-1.6 desde '96 completo con rodamiento Ø 24,5 mm



**1611**  
kit fuelle transmisión l/cambio 1.8-2.0-JTD r.o.



**1835**  
fuelle cremallera dirección r.o.



**2637**  
bieleta puntal barra estabilizadora completa r.o. 7601647+7601642



**2741**  
goma barra estabilizadora r.o. 7635714



**2675** Ø 19,9 mm  
silentbloc anterior brazo suspensión delt. r.o. 7601064



**2674** Ø 19,9 mm  
silentbloc posterior brazo izquierdo delt. r.o. 7601065



**2673** Ø 19,9 mm  
silentbloc posterior brazo derecho delt. r.o.



**2899** Ø 20,9 mm  
silentbloc anterior brazo suspensión delt. r.o.



**2900** Ø 20,9 mm  
silentbloc posterior brazo izquierdo delt. r.o.



**2901** Ø 20,9 mm  
silentbloc posterior brazo derecho delt. r.o.

## FIAT BRAVO-BRAVA-MAREA



**057**  
soporte tubo de escape 1.4-1.6  
r.o.5989798



**083**  
soporte tubo de escape Diesel  
r.o.7664624



**280**  
soporte tubo de escape desde '98  
r.o.60624931



**2636**  
soporte tubo de escape TD-JTD  
r.o.7749062



**2638**  
soporte tubo de escape  
r.o.46421002



**2639**  
soporte tubo de escape TD-JTD  
r.o.46477073



**2919**  
kit reparación brazo suspensión trasero  
completo con rodamientos

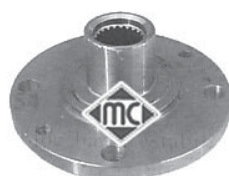

**90016**  
buje rueda delantera 1.4-1.6-1.9D-80-100  
(22 estrías), r.o. 7608131



**90010**  
buje rueda delantera 1.9 TD  
(25 estrías, eje de Ø 37 mm), r.o. 7667265



**90052**  
buje rueda delantera JTD(115)-2.0  
(25 estrías, eje de Ø 42 mm), r.o. 60809805

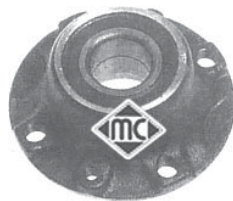

**90508**  
buje rueda trasera sin "Antiskid" (ABS)  
r.o.7787124



**90509**  
buje rueda trasera con "Antiskid" (ABS)  
r.o.60811481



**96033**  
latiguillo freno delantero BRAVO/A (415 mm)  
r.o.46448591



**96042**  
latiguillo freno delantero MAREA (435 mm)  
r.o.46454003



**96031**  
latiguillo freno trasero BRAVO/A (245 mm)  
r.o.7670215



**96043**  
latiguillo freno trasero MAREA (250 mm)  
r.o.7667806

**¡Nuevo!**



**4894**  
polea flexible de alternador  
r.o.

**¡Nuevo!**



**5001**  
polea de alternador de rueda libre  
r.o.9948225

**¡Nuevo!**



**4927**  
tensor correa alternador 1.9D/JTD  
r.o.55180011

## FIAT BRAVO-BRAVA-MAREA



**2789**  
tapón de bloque de Ø 50 mm  
r.o.

*¡Nuevo!*



**4893**  
tapón de bloque de Ø 51 mm  
r.o. 91600682



**4308**  
polea cigueñal 1.9 D/JTD  
r.o. 46780491-60816824-73501275



**3572**  
tapón botella expansión 1.0 bar  
r.o.

*¡Nuevo!*



**3740**  
tapón botella expansión 1.4 bar  
r.o. 46402982

*¡Nuevo!*



**3758**  
botella de expansión 1.6/1.8/2.0/1.9D/TD  
r.o. 46442367

*¡Nuevo!*



**3757**  
caja completa con termostato 1.9D/TD  
r.o. 7625346



**2742**  
tapón llenado aceite motor (1.4 gasolina)  
r.o. 7713649



**4062**  
tapón cárter aceite (18x150)  
r.o. 46476967



**4126**  
tapón cárter aceite (20x150)  
r.o.



## SUSPENSION DELANTERA y SOPORTES DE MOTOR:

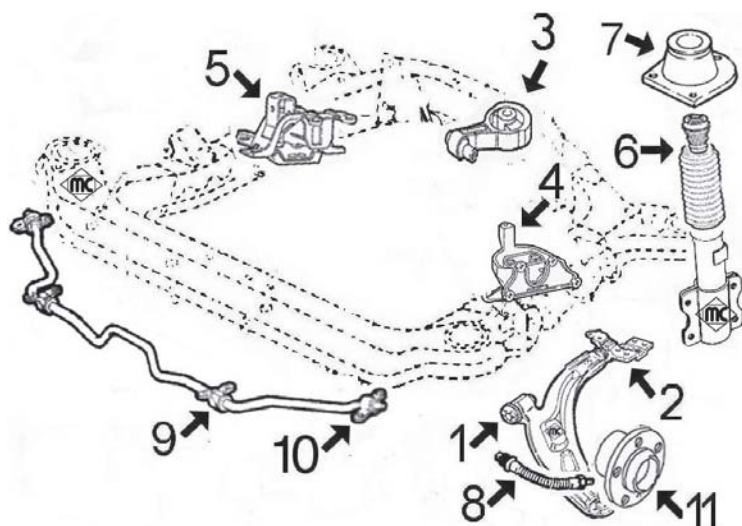

- 1- 4954 silentbloc anterior trapecio delantero
- 2- 4952 silentbloc posterior trapecio delantero derecho  
4951 silentbloc posterior trapecio delantero izquierdo
- 3- 4891 soporte motor trasero 1.2 y 1.9D/JTD
- 4- 4983 soporte motor izquierdo 1.2 y 1.9D/JTD
- 5- 4950 soporte motor derecho 1.2-1.9D/JTD
- 6- 4982 jgo. tope poliuretano y fuelle suspensión delantera
- 7- 4823 soporte amortiguador delantero derecho completo con rodamiento  
4824 soporte amortiguador delantero izquierdo completo con rodamiento
- 8- 96210 latiguillo freno delantero (510 mm)
- 9- 4955 goma para barra estabilizadora de 23 mm  
4956 goma para barra estabilizadora de 24 mm
- 10- 4981 soporte puntal barra estabilizadora
- 11- 90099 buje de rueda delantera

## SUSPENSION TRASERA:

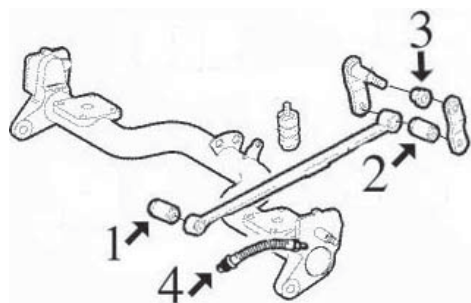

- 1- 4984 silentbloc anterior ballesta trasera
- 2- 4985 silentbloc posterior ballesta trasera (inferior)
- 3- 4986 silentbloc posterior ballesta trasera (superior)
- 4- 96211 latiguillo freno trasero (465 mm)

**¡Nuevo!**



**4823**

soporte amortiguador derecho completo con rodamiento, r.o. 46760674

**¡Nuevo!**



**4824**

soporte amortiguador izquierdo completo con rodamiento, r.o. 46760673

















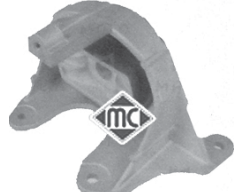

**¡Nuevo!**



**4891**

soporte motor trasero 1.2 y 1.9D/JTD r.o. 46767476

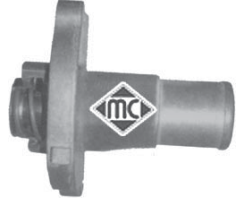
## FIAT DOBLO

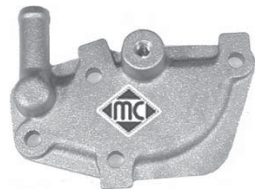
<p><b>¡Nuevo!</b></p>  <p><b>4950</b> soporte motor derecho 1.2 y 1.9D/JTD r.o. 46759568</p>	<p><b>¡Nuevo!</b></p>  <p><b>4951</b> silentbloc posterior trapecio delantero izquierdo, r.o. 51747322</p>	<p><b>¡Nuevo!</b></p>  <p><b>4952</b> silentbloc posterior trapecio delantero derecho, r.o. 51747321</p>
<p><b>¡Nuevo!</b></p>  <p><b>4954</b> silentbloc anterior trapecio delantero r.o. 5174009</p>	<p><b>¡Nuevo!</b></p>  <p><b>4955</b> goma para barra estabilizadora de 23 mm r.o. 46738808</p>	<p><b>¡Nuevo!</b></p>  <p><b>4956</b> goma para barra estabilizadora de 24 mm r.o. 46790552</p>
<p><b>¡Nuevo!</b></p>  <p><b>4981</b> soporte puntal barra estabilizadora r.o. 46841320</p>	<p><b>¡Nuevo!</b></p>  <p><b>4982</b> juego capuchón y tope poliuretano amortiguador delantero, r.o. 46466619+46792633</p>	<p><b>¡Nuevo!</b></p>  <p><b>4983</b> soporte motor izquierdo 1.2 y 1.9D/JTD r.o. 46759737</p>
<p><b>¡Nuevo!</b></p>  <p><b>4984</b> silentbloc anterior ballesta trasera r.o. 46766963-46767261</p>	<p><b>¡Nuevo!</b></p>  <p><b>4985</b> silentbloc posterior ballesta trasera (inferior) r.o. 46473041</p>	<p><b>¡Nuevo!</b></p>  <p><b>4986</b> silentbloc posterior ballesta trasera (superior), r.o. 7763865</p>
<p><b>¡Nuevo!</b></p>  <p><b>96210</b> latiguillo freno delantero (500 mm) r.o. 46738613</p>	<p><b>¡Nuevo!</b></p>  <p><b>96211</b> latiguillo freno trasero (465 mm) r.o. 46749271</p>	<p><b>¡Nuevo!</b></p>  <p><b>90099</b> bujie rueda delantera r.o. 46745258</p>
<p><b>¡Nuevo!</b></p>  <p><b>3736</b> botella de expansión r.o. 51717782</p>	<p><b>¡Nuevo!</b></p>  <p><b>3740</b> tapón botella de expansión 1,40 bar r.o. 46402982</p>	<p><b>¡Nuevo!</b></p>  <p><b>3756</b> tapa completa con termostato 1.2 gasolina r.o. 7589135</p>
<p><b>¡Nuevo!</b></p>  <p><b>3100</b> tubo de agua metálico 1.2 gasolina r.o.</p>	<p><b>¡Nuevo!</b></p>  <p><b>3128</b> boquilla en culata r.o.</p>	<p><b>¡Nuevo!</b></p>  <p><b>4619</b> tapa de agua 1.9 Diesel r.o. 7728241</p>

## FIAT DOBLO

 <p><b>2789</b> tapón de bloque de Ø 50 mm r.o.</p>	 <p><b>4893</b> tapón de bloque de Ø 51 mm r.o. 91600682</p>	 <p><b>4308</b> polea cigüeñal 1.9 D/JTD r.o. 46780491-60816824-73501275</p>
 <p><b>5041</b> polea cigüeñal 1.3JTD '04- r.o. 55182506</p>	 <p><b>4894</b> polea elástica de alternador r.o.</p>	 <p><b>5001</b> polea de alternador de rueda libre r.o. 9948225</p>
 <p><b>4927</b> tensor correa alternador 1.9D-JTD r.o. 55180011</p>	 <p><b>3754</b> juego cubiertas correa distribución 1.2 r.o. 46773346+46782206</p>	 <p><b>3685</b> tapón llenado aceite motor 1.3JTD r.o. 55197222-73501331</p>
 <p><b>1996</b> kit fuelle transm. lado rueda 1.2-1.9D (Ø24-79 mm), r.o.</p>	 <p><b>1432</b> kit fuelle transm. lado rueda 1.9JTD (Ø26-84 mm), r.o.</p>	 <p><b>1120</b> kit fuelle transm. lado cambio completo con rodamiento de Ø 24,50 mm, 1.2-1.9D</p>
 <p><b>1148</b> kit fuelle transm. lado cambio 1.9JTD r.o.</p>	 <p><b>1196</b> fuelle cremallera dirección r.o.</p>	
 <p><b>2639</b> soporte tubo de escape r.o. 46416588</p>	 <p><b>2754</b> soporte tubo de escape r.o. 46515903</p>	 <p><b>4062</b> tapón cárter de aceite 18x150 r.o. 46476967</p>
 <p><b>4126</b> tapón cárter de aceite 20x150 r.o.</p>	 <p><b>676</b> tapón cárter de aceite 22x150 r.o.</p>	 <p><b>413</b> cubrepedal freno y embrague r.o. 4170605</p>

## FIAT DUCATO hasta -1994



**7346**  
mgto superior e inferior radiador  
r.o.5933431-5933432



**3526**  
botella de expansión  
r.o.4431399

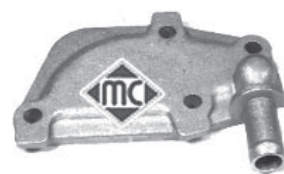

**3141**  
tapa aluminio en culata desde '90  
r.o.5932811



**3123**  
tubo de agua metálico D-TD desde '90 hasta '94, r.o.98455449(7303545)



**709**  
goma puntal tensor brazo delantero  
r.o.4339248



**2863**  
silentbloc brazo delantero  
r.o. no hay despiece



**1579**  
kit rep. transmisión l/rueda hasta '94  
r.o.95569342



**1580**  
kit rep. transmisión l/cambio  
r.o.95569341



**1820**  
fuelle cremallera asistida  
r.o.9945837



**1620**  
fuelle derecho cremallera manual  
r.o.9750000380



**1621**  
fuelle izquierdo cremallera manual  
r.o.9750000280

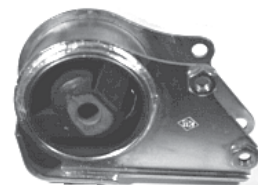

**837**  
soporte cambio desde '91  
r.o.7663999



**650**  
soporte cambio hasta '91  
r.o.4456819



**90031**  
bujie rueda delantera desde '90 (cuello para retén de Ø 69 mm), r.o.



**366**  
soporte tubo de escape (Ø 32x59)  
r.o.4437668



**96144**  
latiguillo freno delantero (455 mm)  
r.o.



**96095**  
latiguillo intermedio trasero (290 mm)  
r.o.



**3607**  
tapón botella radiador 0,70 bar  
r.o.



**667**  
tapón cárter de aceite 16x150  
r.o.



**CANALIZACIONES DE AGUA:**

**motores PSA 1.9 D (1905 W3)  
1.9 TD (1905 TD W3):**

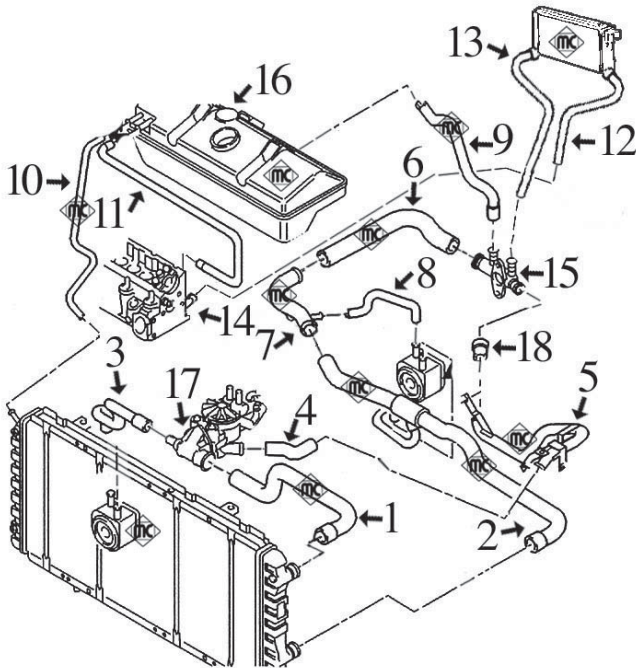

- 1- 8500 mgto superior radiador
- 2- 8502 mgto inferior radiador
- 3- 8506 mgto de tapa termostato a intercambiador
- 4- 8183 mgto de caja termostato a tubo hasta '98  
8480 mgto de caja termostato a tubo desde '98
- 5- 3057 tubo de agua metálico
- 6- 8505 mgto de tubo metálico a racor plástico
- 7- 3131 tubo de agua metálico
- 8- 8501 mgto de intercambiador a tubo metálico
- 9- 8507 mgto de racor plástico a botella
- 10- 116 mgto de botella a radiador. Cortar de rollo MC-116  
Ø 8 x 15 mm longitud 720 mm
- 11- 8504 mgto de botella a culata
- 12- 8537 mgto de calefactor a culata
- 13- 8538 mgto de calefactor a racor plástico
- 14- 3059 boquilla en culata
- 15- 3503 racor plástico conexión mgto.
- 16- 3572 tapón botella expansión 1.0 bar
- 17- 3546 tapa de termostato
- 18- 8312 mgto de tubo metálico a racor plástico

**motores PSA 2.0HDi (DW10TD) y 2.2HDi (DW12TED):**

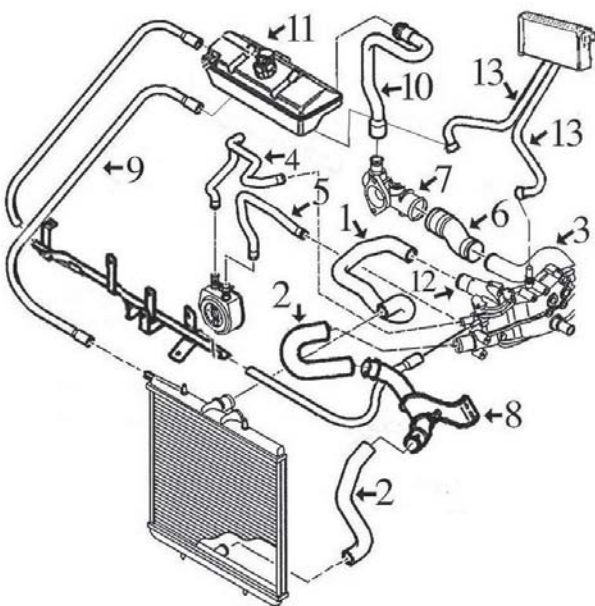

- 1- 8897 mgto superior radiador
  - 2- 8898 mgto inferior radiador (2 tramos)
  - 3- 3139 tubo de agua metálico 2.0HDi  
3174 tubo de agua metálico 2.2HDi
  - 4- 8554 mgto de intercambiador a caja termostato
  - 5- 8586 mgto de intercambiador a caja termostato
  - 6- 8587 mgto de tubo metálico a tapa bomba 2.0HDi  
8950 mgto de tubo metálico a tapa bomba 2.2HDi
  - 7- 3554 tapa bomba de agua conexión manguitos
  - 8- 3169 tubo de agua metálico empalme mgto inferior
  - 9- n/d mgto de botella a radiador
  - 10- n/d mgto de botella a tapa bomba
  - 11- 3572 tapón botella expansión
  - 12- 3135 tapa de termostato
  - 13- 8946 juego mgto de calefacción
- 8540 mgto desvaporizador

motores FIAT

1.9 Diesel (1930 DS)  
1.9 TurboDiesel (1930 TDS)

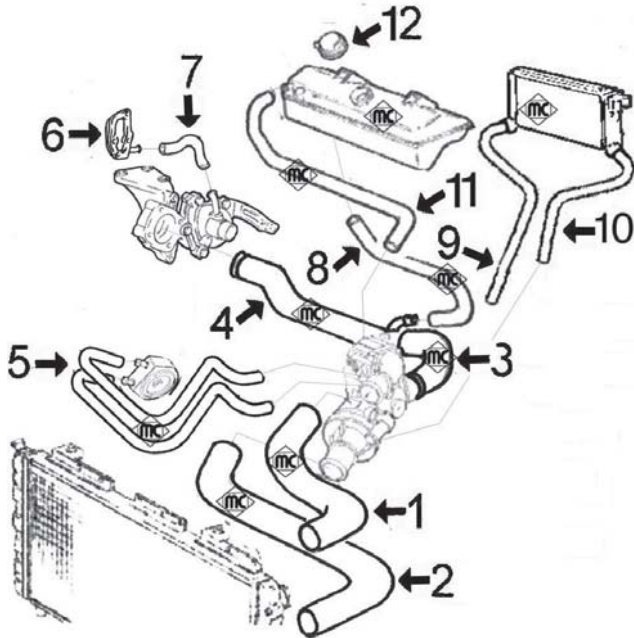

- 1- 8838 mgto superior radiador
- 2- 8839 mgto inferior radiador
- 3- 8819 mgto de caja termostato a tubo metálico
- 4- 3153 tubo de agua metálico con junta tórica
- 5- 8833 juego de tubos de caja termostato a intercambiador
- 6- 3141 tapa de aluminio en culata
- 7- 117 mgto de bomba de agua a tapa aluminio en culata: cortar de rollo MC-117 Ø 10x17 mm long. 120 mm
- 8- 8837 mgto de botella a tubo metálico
- 9- 8830 mgto de calefactor a culata
- 10- 8836 mgto de calefactor a caja termostato
- 11- 117 mgto de botella a caja termostato: cortar de rollo MC-117 Ø 10x17 mm long. 450 mm
- 12- 3572 tapón botella de expansión

motores SOFIM 2.5D/TD-2.8D/TD y 2.8HDi:

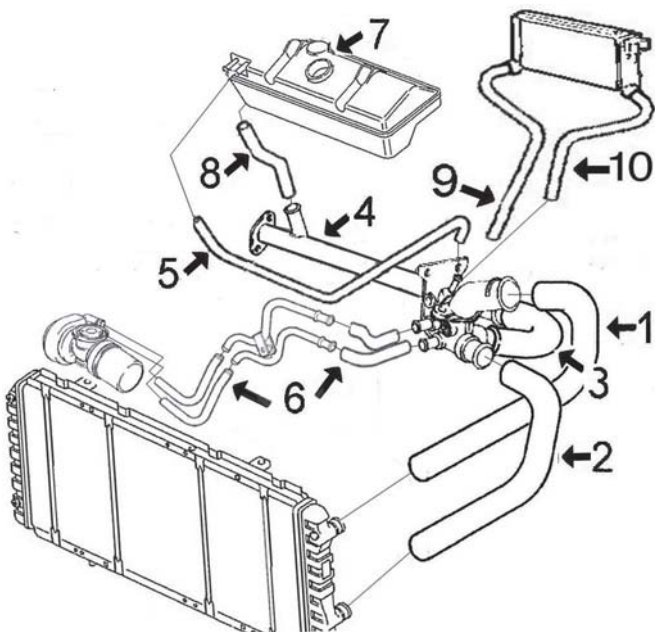





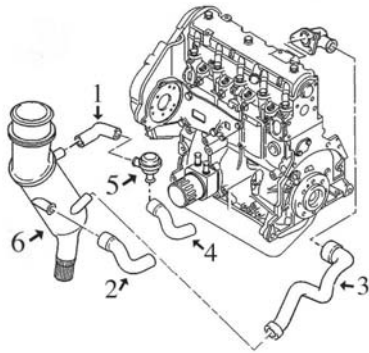

- 1- 8842 mgto superior radiador
- 2- 8843 mgto inferior radiador
- 3- 8832 mgto de caja termostato a tubo metálico
- 4- 3124 tubo de agua metálico
- 5- 117 mgto de caja termostato a botella: cortar de rollo MC-117 Ø 10x17 mm long. 420 mm
- 6- 8835 juego 4 mgto de caja termostato a tubos metálicos y de tubos a intercambiador
- 7- 3572 tapón botella de expansión
- 8- 843 mgto de tubo metálico a botella: cortar de rollo MC-843 Ø 19x25 mm long. 420 mm
- 9- 8840 mgto de calefactor a culata
- 10- 8841 mgto de calefactor a caja termostato

**mgtos. DESVAPORIZADORES 1.9 Diesel (XUD9) y TurboD (XUD9TE)  
(motores PSA)**



- 1- 8167 mgto de decantador a regulador motor 1.9 Diesel
- 8492 mgto de decantador a regulador motor 1.9 TurboD
- 2- 8166 mgto de cárter a decantador motores D+TD
- 3- 8494 mgto de decantador a culata D+TD
- 4- 8493 mgto de regulador a filtro aire TD
- 5- 3637 válvula desvaporizadora
- 6- 3666 decantador completo con tapón y junta tórica

 <p><b>8183</b> mgto de caja termostato a tubo 1.9D h/'98 r.o. 1307.W3</p>	 <p><b>8312</b> mgto de tubo metálico a racor plástico r.o. 1307.W4</p>	 <p><b>8480</b> mgto de caja termostato a tubo desde '98 r.o.</p>
 <p><b>8500</b> mgto superior radiador 1.9 D-TD r.o.</p>	 <p><b>8501</b> mgto de intercambiador a tubo metálico 1.9 r.o.</p>	 <p><b>8502</b> mgto inferior radiador 1.9 D-TD r.o.</p>
 <p><b>8504</b> mgto de botella a culata 1.9 D-TD r.o.</p>	 <p><b>8505</b> mgto de tubo metálico a racor plástico 1.9 r.o.</p>	 <p><b>8506</b> mgto de caja termostato a intercambiador r.o.</p>
 <p><b>8507</b> mgto de racor plástico a botella 1.9 r.o.</p>	 <p><b>8537</b> mgto de calefactor a culata 1.9 r.o.</p>	 <p><b>8538</b> mgto de calefactor a racor plástico 1.9 r.o.</p>
 <p><b>8554</b> mgto de intercambiador 2.0-2.2HDi r.o.</p>	 <p><b>8586</b> mgto de intercambiador 2.0-2.2HDi r.o.</p>	 <p><b>8587</b> mgto de tubo a tapa 2.0HDi r.o.</p>

## FIAT DUCATO desde 1994-



**8819**  
mgto de caja termostato a tubo metálico  
1.9D-TD MOTORFIAT, r.o.



**8830**  
mgto calefactor 1.9D-TD  
MOTORFIAT, r.o.



**8832**  
mgto de caja termostato a tubo 2.8HDi  
r.o.



**8833**  
jgo mgto a intercambiador 1.9D-TD  
MOTORFIAT, r.o.



**8835**  
jgo 4 mgto a intercambiador 2.5-2.8  
MOTORFIAT, r.o.



**8836**  
mgto calefactor 1.9D-TD  
MOTORFIAT, r.o.



**8837**  
mgto de tubo metálico a botella 1.9D-TD  
MOTORFIAT, r.o.



**8838**  
mgto superior radiador 1.9D-TD  
MOTORFIAT, r.o.



**8839**  
mgto inferior radiador 1.9D-TD  
MOTORFIAT, r.o.



**8840**  
mgto de calefactor a culata 2.8HDi  
r.o.



**8841**  
mgto de calefactor a caja termost. 2.8HDi  
r.o.



**8842**  
mgto superior radiador 2.8HDi  
r.o.



**8843**  
mgto inferior radiador 2.8HDi  
r.o.



**8897**  
mgto sup radiador 2.0-2.2HDi  
r.o.



**8898**  
mgto inferior radiador 2.0-2.2HDi (2 tramos)  
r.o.



**8946**  
jgo mgto calefactor 2.0-2.2HDi  
r.o.



**8950**  
mgto de tubo a tapa de plástico 2.2HDi  
r.o.



**8166**  
mgto desvaporizador 1.9 D y TD  
r.o. 1192.48



**8167**  
mgto desvaporizador 1.9 D  
r.o. 1180.A3



**8492**  
mgto desvaporizador 1.9 TD  
r.o.



## FIAT DUCATO desde 1994-



**8493**

mgto desvaporizador 1.9 D y TD  
r.o.



**8494**

mgto desvaporizador 1.9 TD  
r.o.



**8540**

mgto desvaporizador 2.0 HDi-2.2 HDi  
r.o.



**3057**

tubo de agua metálico 1.9 D-TD  
r.o. 1307.W2



**3059**

boquilla en culata 1.9 D-TD  
r.o. 0245.42-0245.44



**3124**

tubo de agua metálico 2.8 HDi  
r.o.



**3131**

tubo de agua metálico 1.9 D-TD  
r.o.



**3135**

tapa de termostato 2.0-2.2 HDi  
r.o.



**3139**

tubo de agua metálico 2.0 HDi  
r.o.



**3141**

tapa aluminio en culata 1.9 D-TD  
MOTORFIAT, r.o. 5932811



**3153**

tubo de agua 1.9 D-TD  
MOTORFIAT, r.o. 1308350080

**¡Nuevo!**



**3169**

tubo de empalme mgto inferior 2.0-2.2 HDi  
r.o. 1307.XX

**¡Nuevo!**



**3174**

tubo de agua metálico 2.2 HDi con junta  
r.o. 1307.SJ



**3503**

racor plástico conexión mgts 1.9 D-TD  
r.o. 1336.G4



**3523**

racor plástico conexión mgts 2.0 gasolina  
r.o. 1336.H7



**3546**

tapa de termostato 1.9 D - TD  
r.o. 1336.G3



**3554**

racor plástico conexión mgts 2.0-2.2 HDi  
r.o. 1336.P5



**3572**

tapón botella expansión 1.0 bar  
r.o. 1306.E1

**¡Nuevo!**



**3637**

válvula desvaporizadora 1.9 D XUD9  
r.o. 0361.58

**¡Nuevo!**



**3666**

decantador completo con tapón y junta  
1.9 D(XUD9), r.o. 1180.C0+1170.17

**SUSPENSION DELANTERA y SOPORTES DE MOTOR HASTA -2002:**

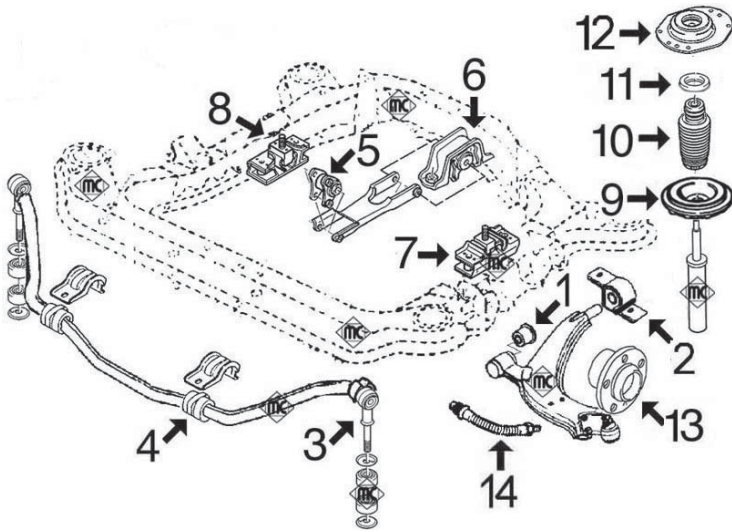

- 1- 2872 silentbloc anterior trapecio delantero
- 2- 2873 silentbloc posterior trapecio delantero
- 3- 2956 bieleta puntal barra estabilizadora completa
- 4- n/d goma barra estabilizadora
- 5- 2985 silentbloc tirante posterior motor
- 6- 2984 soporte motor trasero
- 7- 2987 soporte motor izquierdo 2.0-1.9D-2.5D-2.8D  
4565 soporte motor izquierdo 2.0HDi-2.2HDi-2.8HDi
- 8- 2986 soporte motor derecho 2.0-1.9D-2.5D-2.8D  
4565 soporte motor derecho 2.0HDi-2.2HDi-2.8HDi
- 9- 4446 soporte superior muelle delantero
- 10- 4616 capuchón con tope amortiguador 1.000/1.400 Kg.  
4617 capuchón con tope amortiguador 1.800 Kg.
- 11- 4182 rodamiento soporte amortiguador delantero
- 12- 2918 soporte amortiguador izquierdo  
2925 soporte amortiguador derecho
- 13- 90039 buje de rueda delantera 1.000-1.400 Kg.  
90040 buje de rueda delantera 1.800 Kg.
- 14- 96102 latiguillo freno delantero (490 mm)

**SUSPENSION DELANTERA y SOPORTES DE MOTOR DESDE 2002:**

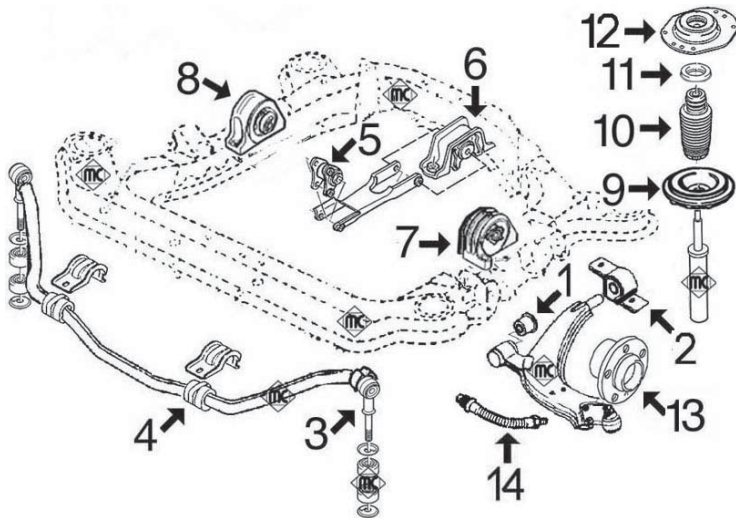

- 1- 2872 silentbloc anterior trapecio delantero
- 2- 2873 silentbloc posterior trapecio delantero
- 3- 2956 bieleta puntal barra estabilizadora completa
- 4- n/d goma barra estabilizadora
- 5- 2985 silentbloc tirante posterior motor
- 6- 2984 soporte motor trasero
- 7- 4566 soporte motor izquierdo
- 8- 4567 soporte motor derecho
- 9- 4446 soporte superior muelle delantero
- 10- 4616 capuchón con tope amortiguador 1.000/1.400 Kg.  
4617 capuchón con tope amortiguador 1.800 Kg.
- 11- 4182 rodamiento soporte amortiguador delantero
- 12- 4570 soporte amortiguador izquierdo  
4571 soporte amortiguador derecho
- 13- 90039 buje de rueda delantera 1.000-1.400 Kg.  
90040 buje de rueda delantera 1.800 Kg.
- 14- 96102 latiguillo freno delantero (490 mm)

**SUSPENSION TRASERA:**

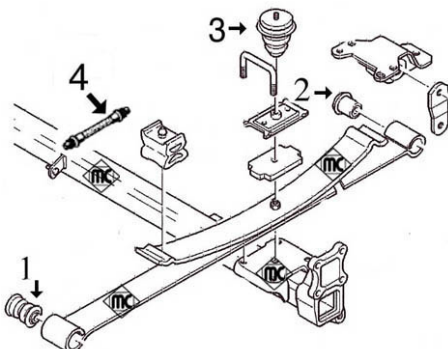

- 1- 2954 silentbloc anterior ballesta
- 2- 2955 silentbloc posterior ballesta
- 3- 2957 tope poliuretano
- 4- 96145 latiguillo freno trasero (360 mm)

## FIAT DUCATO desde 1994-

 <p><b>2872</b> silentbloc anterior trapecio delantero r.o.</p>	 <p><b>2873</b> silentbloc posterior trapecio delantero r.o.</p>	 <p><b>2918</b> soporte amortiguador izquierdo r.o.5038.18-5038.41</p>
 <p><b>2925</b> soporte amortiguador derecho r.o. 5038.19-5038.42</p>	 <p><b>2954</b> silentbloc anterior ballesta trasera r.o.5131.73</p>	 <p><b>2955</b> silentbloc posterior ballesta trasera r.o.5131.72</p>
 <p><b>2956</b> bieleta puntal barra estabilizadora completa r.o.5087.37+5093.15</p>	 <p><b>2957</b> tope poliuretano suspensión posterior r.o.</p>	 <p><b>2984</b> soporte motor trasero r.o.1846.66</p>
 <p><b>2985</b> silentbloc tirante posterior motor r.o.1846.65</p>	 <p><b>2986</b> soporte motor derecho r.o.1844.46</p>	 <p><b>2987</b> soporte motor izquierdo r.o.1827.17-1827.18</p>
 <p><b>4182</b> rodamiento soporte suspensión r.o.5035.47</p>	 <p><b>4446</b> soporte superior muelle suspensión delant. r.o.5031.40-5031.75</p>	 <p><b>4565</b> soporte motor 2.0-2.0HDi-2.8HDi hasta '01 r.o.1807.R5-1801.39-1839.A0-1802.53</p>
 <p><b>4566</b> soporte motor izqdo. todos tipos desde '01 r.o.1801.T1-1807.S9-1807.S7</p>	 <p><b>4567</b> soporte motor dcho. todos tipos desde '01 r.o.1839.A6-1802.56-1839.AT</p>	 <p><b>4570</b> soporte dcho. amortiguador delt. desde '01 r.o.5038.87-5038.72</p>
 <p><b>4571</b> soporte izqdo. amortiguador delt. desde '01 r.o. 5038.89</p>	 <p><b>4616</b> capuchón con tope amortg. delt. 1.000-1.400 kgs, r.o. 5033.41</p>	 <p><b>4617</b> capuchón con tope amortg. delt. 1.800 kgs. r.o.5033.42</p>



FIAT DUCATO desde 1994-



**90039**

buje de rueda delantera 1.000-1.400 Kgs.  
r.o. 3307.65



**90040**

buje de rueda delantera 1.800 Kgs.  
r.o. 3307.66



**96102**

latiguillo freno delantero (490 mm)  
r.o.



**96145**

latiguillo freno trasero (360 mm)  
r.o.

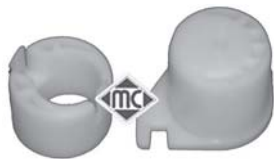

**4043**

juego casquillos horquilla embrg. 1.9D-TD  
r.o. 2175.20+2175.21



**4052**

horquilla embregue completa  
2.0XU y 1.9Diesel y TD, r.o. 2115.25



**¡nuevo!**



**4601**

horquilla embregue 2.0HDi  
r.o. 2117.66-2117.57

**¡nuevo!**



**4554**

pedal embregue completo con muelle retorno  
r.o. 2127.A4+2148.31



**2926**

polea cigueñal 1.9 D-TD hasta '97  
r.o. 0515.G3



**4202**

polea cigueñal 1.9 D-TD desde '97  
r.o. 0515.K4

**¡nuevo!**



**4201**

polea cigueñal 2.5 D-TD  
r.o. 0515.H3



**2928**

Ø162 mm 6 canales  
polea cigueñal 2.0 HDi (hasta 5/'04)-2.2 HDi  
sin aire ac., r.o. 0515.P2

**¡nuevo!**



**4798**

Ø158 mm 6 canales  
polea cigueñal 2.0 HDi (desde 5/'04)-2.2 HDi  
con aire ac., r.o. 0515.S8

**¡nuevo!**



**5042**

polea cigueñal 2.3JTD desde '02-  
r.o. 504076697

**¡nuevo!**



**4568**

polea cigueñal 2.8D-TD-2.8 HDi  
r.o. 0515.P3-0515.P9-0515.N2



**4308**

polea cigueñal 1.9D/TD MOTORFIAT  
r.o. 46780491-60816824



**4197**

cardán dirección cremallera manual  
r.o. 4103.E6



**1820**

fuelle cremallera dirección  
r.o. 4006.22



## FIAT DUCATO desde 1994-

 <p><b>1225</b> kit rep. transmisión l/rda. 1.000-1400 Kg. r.o. 3293.98</p>	 <p><b>2307</b> kit rep. transmisión l/rda. 1.800 Kg. hasta '96, r.o. 3293.99</p>	 <p><b>1391</b> kit rep. transmisión l/rda. 1.800 Kg. desde '96, r.o. 3293.07</p>
 <p><b>1362</b> kit rep. transmisión l/cbo. "1.000 Kg." r.o. 3287.90</p>	 <p><b>1407</b> kit rep. transmisión l/cbo. "1.800 Kg." r.o. 3287.78</p>	
<p><b>¡Nuevo!</b></p>  <p><b>3698</b> juego tapas correa distribución 1.9XUD r.o. 0320.H2/H3/F9</p>	<p><b>¡Nuevo!</b></p>  <p><b>3699</b> juego tapas correa distribución 2.0HDI r.o. 0320.N5/N6/S7</p>	<p><b>¡Nuevo!</b></p>  <p><b>4807</b> tensor correa alternador 2.0HDI sin a/c r.o. 5751.30</p>
<p><b>¡Nuevo!</b></p>  <p><b>5043</b> tensor correa alternador 2.0/2.2HDI desde '04 r.o. 5751.74</p>	<p><b>¡Nuevo!</b></p>  <p><b>4620</b>      Ø 32/50 y 40/58 mm juego retenes diferencial-transmisión r.o. 3121.24+3121.44</p>	<p><b>¡Nuevo!</b></p>  <p><b>3642</b> tapón llenado aceite 2.0HDI-2.2HDI r.o. 1180.F9</p>
<p><b>¡Nuevo!</b></p>  <p><b>4995</b> rodillo tensor correa alternador 2.0HDI r.o. 5751.29</p>	<p><b>¡Nuevo!</b></p>  <p><b>4915</b>      Ø 54,60 mm polea de alternador de rueda libre (motor PSA), r.o.</p>	<p><b>¡Nuevo!</b></p>  <p><b>4916</b>      Ø 58,50 mm polea de alternador de rueda libre (motor PSA), r.o.</p>
<p><b>¡Nuevo!</b></p>  <p><b>5001</b>      Ø 65,50 mm polea de alternador de rueda libre (motores FIAT), r.o.</p>	<p><b>¡Nuevo!</b></p>  <p><b>4894</b> polea elástica de alternador (motores FIAT), r.o.</p>	
<p><b>¡Nuevo!</b></p>  <p><b>4479</b> soporte tapa motor HDi r.o. 0137.11</p>	<p><b>2392</b>      junta de Ø 60 x 46 mm kit montaje colector escape 1.9 Diesel r.o. 1798.76</p> 	<p><b>2940</b>      junta de Ø 80 x 66 mm kit montaje colector escape 1.9 TD y 2.5 r.o.</p> 







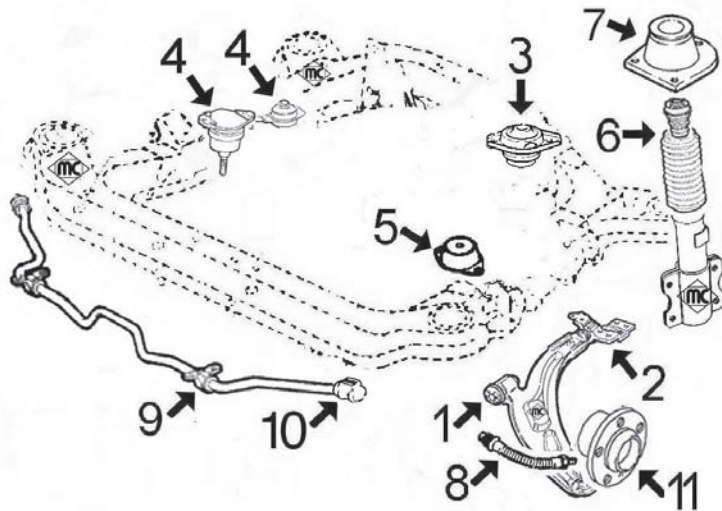

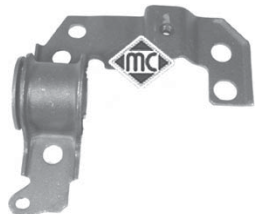

FIAT DUCATO desde 1994-

<p><b>¡Nuevo!</b></p>  <p><b>4598</b> junta de Ø 80 x 66 mm kit montaje colector escape 2.0HDi-2.2HDi-2.8HDi-Sofim 2.5TD, r.o.</p>	<p><b>¡Nuevo!</b></p>  <p><b>4599</b> junta de Ø 60 x 46 mm kit montaje colector escape Sofim 2.5D-2.8TD, r.o.</p>	 <p><b>366</b> soporte tubo de escape (32x59 mm) r.o.1755.60</p>
 <p><b>4010</b> soporte tubo escape 2.0HDi-2.2HDi r.o.1755.68</p>	 <p><b>2638</b> soporte tubo de escape r.o.1755.65</p>	 <p><b>2452</b> tapón cárter aceite 14 x 125 r.o.0311.21</p>
 <p><b>667</b> tapón cárter aceite 16 x 150 r.o.0163.88</p>		

SUSPENSION DELANTERA y SOPORTES DE MOTOR:

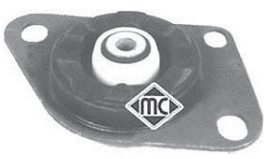

- 1- 4954 silentbloc anterior trapecio delantero
- 2- 4952 silentbloc posterior trapecio delantero derecho
- 4951 silentbloc posterior trapecio delantero izquierdo
- 3- 5087 soporte motor trasero-izquierdo 1.2-1.6-1.7TD-1.9D
- 4- 5086 soporte motor derecho 1.2
- 5089 soporte motor derecho 1.6-1.7TD-1.9D
- 5- 5088 soporte motor delant.-izquierdo 1.2-1.6-1.7TD-1.9D
- 6- 4982 jgo. tope poliuretano y fuelle suspensión delantera
- 7- 4823 soporte amortiguador delantero derecho completo con rodamiento
- 4824 soporte amortiguador delantero izquierdo completo con rodamiento
- 8- 96210 latiguillo freno delantero (510 mm)
- 9- 4955 goma central barra estabilizadora
- 10- 4953 goma puntal barra estabilizadora
- 11- 90099 buje de rueda delantera 1.9D desde '02-

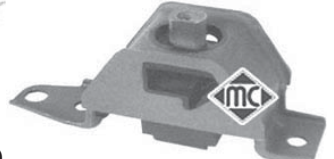
<p><b>¡Nuevo!</b></p>  <p><b>4823</b> soporte amortiguador derecho completo con rodamiento, r.o. 46760674</p>	<p><b>¡Nuevo!</b></p>  <p><b>4824</b> soporte amortiguador izquierdo completo con rodamiento, r.o. 46760673</p>	<p><b>¡Nuevo!</b></p>  <p><b>4951</b> silentbloc posterior trapecio delantero izquierdo, r.o. 51747322</p>
<p><b>¡Nuevo!</b></p>  <p><b>4952</b> silentbloc posterior trapecio delantero derecho, r.o. 51747321</p>	<p><b>¡Nuevo!</b></p>  <p><b>4953</b> goma puntal barra estabilizadora r.o. 7520850</p>	<p><b>¡Nuevo!</b></p>  <p><b>4954</b> silentbloc anterior trapecio delantero r.o. 5174009</p>
<p><b>¡Nuevo!</b></p>  <p><b>4955</b> goma central barra estabilizadora r.o. 46738808</p>	<p><b>¡Nuevo!</b></p>  <p><b>4982</b> juego capuchón y tope poliuretano amortiguador delantero, r.o. 46466619+46792633</p>	<p><b>¡Nuevo!</b></p>  <p><b>5086</b> soporte motor derecho 1.2 r.o. 46523938</p>
<p><b>¡Nuevo!</b></p>  <p><b>5087</b> soporte motor trasero-izquierdo 1.2-1.6-1.7TD-1.9D, r.o. 46540380-46440552</p>	<p><b>¡Nuevo!</b></p>  <p><b>5088</b> soporte motor delantero-izquierdo 1.2-1.6-1.7TD-1.9D, r.o. 46520124-51709070</p>	<p><b>¡Nuevo!</b></p>  <p><b>5089</b> soporte motor derecho 1.6-1.7TD-1.9D r.o. 46439600-46440550</p>

## FIAT PALIO-SIENA



**96210**  
latiguillo freno delantero (500 mm)  
r.o. 46738613



**96043**  
latiguillo freno trasero (250 mm)  
r.o. 7667806



**90099**  
bujе rueda delantera 1.9TD desde '02-  
r.o. 46745258



**90523**  
bujе rueda trasera con rodamiento  
r.o. 7769902



**3740**  
tapón botella de expansión 1,40 bar  
r.o. 46402982



**3743**  
botella de expansión 1.2-1.6 gasolina  
r.o. 46425870



**3748**  
botella de expansión 1.7TD-1.9D  
r.o. 46440542



**3753**  
cubierta correa distribución 1.2  
r.o. 7748306



**2789**  
tapón de bloque de Ø 50 mm  
r.o.

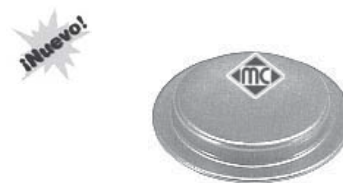

**4893**  
tapón de bloque de Ø 51 mm  
r.o. 91600682



**5041**  
polea de cigüeñal 1.3 Diesel (2002-)  
r.o. 55182506



**4894**  
polea flexible de alternador  
r.o.



**5001**  
polea de alternador de rueda libre  
r.o. 9948225



**4308**  
polea de cigüeñal 1.9 Diesel  
r.o.

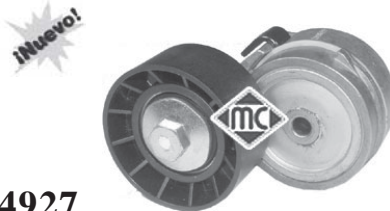

**4927**  
tensor correa alternador 1.9D  
r.o. 55180011



**5090**  
tensor correa alternador 1.2  
r.o. 46548452



**3100**  
tubo de agua metálico 1.2 con junta tórica  
r.o. 46419454



**3193**  
tubo de agua metálico 1.2 con junta  
r.o. 46527322



**3096**  
tubo de agua metálico 1.7TD con junta  
r.o. 7721394



## FIAT PALIO-SIENA

<p><b>4619</b> tapa aluminio bomba de agua 1.9D/JTD r.o. 7728241</p> 	<p><b>3756</b> tapa con termostato 1.2 r.o. 7589135</p> 	
<p><b>1618</b> kit fuelle transmisión l/rueda 1.2 r.o.</p> 	<p><b>1996</b> kit fuelle transmisión l/rueda 1.6-1.7TD-1.9D r.o.</p> 	<p><b>1079</b> kit fuelle transmisión l/cambio r.o.</p> 
<p><b>1583</b> kit fuelle transmisión l/cambio completo con rodamiento de Ø 23,0 mm</p> 	<p><b>1120</b> kit fuelle transmisión l/cambio completo con rodamiento de Ø 24,5 mm</p> 	<p><b>1617</b> fuelle cremallera manual r.o.</p> 
<p><b>1835</b> fuelle cremallera asistida r.o.</p> 	<p><b>2742</b> tapón llenado aceite motor 1.2 r.o. 7728241</p> 	<p><b>3685</b> tapón llenado aceite motor 1.3JTD (2002-) r.o. 55197222-73501331</p> 
<p><b>413</b> cubrepedal freno y embrague r.o.</p> 	<p><b>2639</b> soporte tubo de escape r.o. 7718578</p> 	<p><b>2638</b> soporte tubo de escape r.o. 7740653-7718577</p> 
<p><b>4062</b> tapón cárter aceite 18x150 r.o.</p> 	<p><b>4126</b> tapón cárter aceite 20x150 r.o.</p> 	<p><b>676</b> tapón cárter aceite cónico 22x150 r.o.</p> 

## FIAT PUNTO-I (1993-1999)



**8459**  
mgto superior radiador 55-60-75  
r.o. 7718664-7770566-7745653

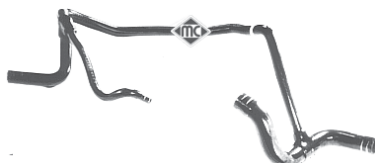

**8460**  
mgto inferior radiador 55-60-75  
r.o. 7797503-7772356



**8468**  
mgto calefactor 55-60  
r.o. 7755054



**2837**  
boquilla 4 vias 55-60  
r.o. 7603190



**3038**  
tubo de agua metálico 55-60-75 hasta '94  
r.o. 7634934



**3100**  
tubo de agua metálico 55-60-75 desde '94  
r.o. 46419454



**8461**  
mgto superior radiador TurboD  
r.o. 7730814

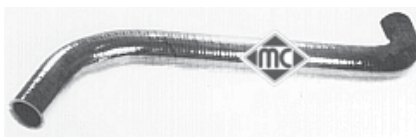

**8462**  
mgto inferior radiador TurboD  
r.o. 7730815



**3096**  
tubo de agua metálico TurboD con junta  
tórica, r.o. 7721394



**8467**  
mgto de termostato a tubo metálico TD  
r.o. 4368408



**3128**  
boquilla metálica en colector  
r.o. 7747183



**3530**  
botella de expansión 1.7D/TD  
r.o. 7745647

**¡Nuevo!**



**3760**  
botella de expansión 1.2 aire acondicionado  
r.o. 7760964



**3740**  
tapón botella de expansión 1,4 bar  
r.o. 46402982



**3572**  
tapón botella de expansión 1,0 bar  
r.o. 46402983

**¡Nuevo!**

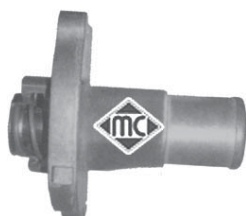

**3756**  
tapa completa con termostato 1.1-1.2  
r.o. 7589135

**¡Nuevo!**

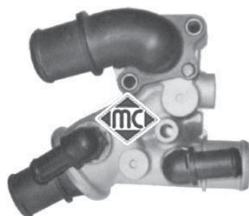

**3755**  
caja de termostato completa 1.7TD  
r.o. 7741883-7741884

SUSPENSION DELANTERA y SOPORTES DE MOTOR:

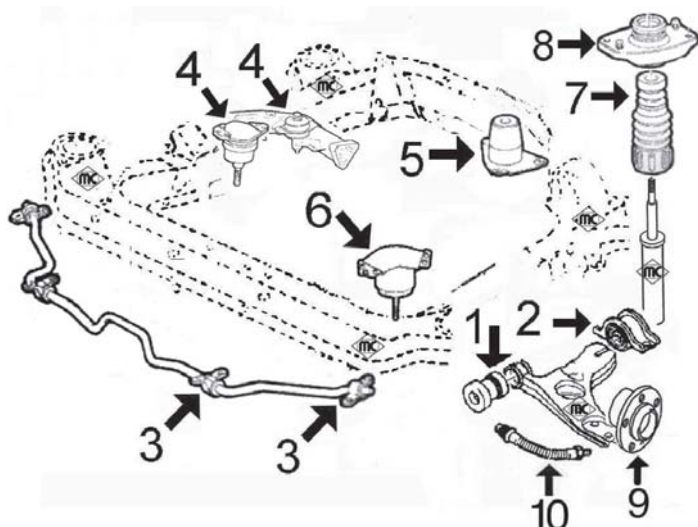

- 1- 486 silentbloc anterior trapecio delantero
- 2- 2826 silentbloc posterior trapecio delantero derecho
- 2827 silentbloc posterior trapecio delantero izquierdo
- 3- 2834 goma para barra estabilizadora de 19 mm
- 2835 goma para barra estabilizadora de 21 mm
- 4- 5079 silentbloc en soporte motor derecho gasolina
- 5082 soporte motor derecho Diesel y TurboD
- 5- 5081 soporte motor trasero
- 6- 5080 soporte motor delantero izquierdo
- 7- 2820 capuchón amortiguador delantero
- 8- 4980 soporte amortiguador delantero
- 9- 90016 buje rueda delantera de 22 estrias (gasolina)
- 90010 buje rueda delantera de 25 estrias (Diesel y TD)
- 10- 96045 latiguillo freno delantero (420 mm)

SUSPENSION TRASERA:

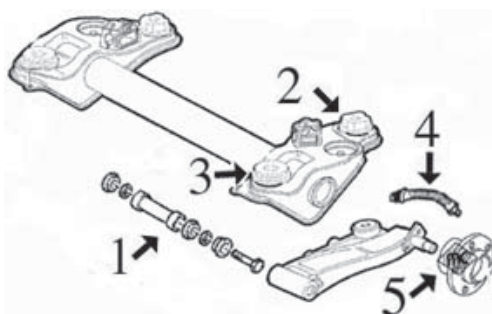

- 1- 2920 juego completo reparación rodamientos brazo tras.
- 2- 4372 silentbloc posterior puente trasero
- 3- 4373 silentbloc anterior puente trasero
- 4- 96020 latiguillo freno trasero (218 mm)
- 5- 90508 buje rueda trasera para vehículos sin Antiskid
- 90523 buje rueda trasera para vehículos con Antiskid

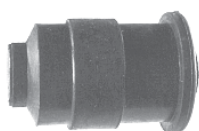

**486**  
silentbloc anterior brazo delantero susp.  
r.o. 5927292



**2820**  
capuchón amortiguador delantero  
r.o. 7762158



**2826**  
silentbloc posterior brazo delt. **derecho**  
r.o.



**2827**  
silentbloc posterior brazo delt. **izquierdo**  
r.o.





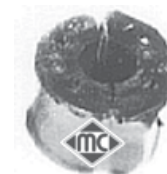













**2834**  
goma barra estabilizadora **Ø 19 mm**  
r.o. 7780450

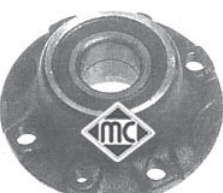

**2835**  
goma barra estabilizadora **Ø 21 mm**  
r.o. 7750982

## FIAT PUNTO-I (1993-1999)

 <p><b>2920</b> kit reparación brazo suspensión trasero completo con rodamientos</p>	 <p><b>4372</b> silentbloc posterior puente trasero r.o. 7756218</p>	 <p><b>4373</b> silentbloc anterior puente trasero r.o. 7755671</p>
<p><i>¡Nuevo!</i></p>  <p><b>4980</b> soporte amortiguador delantero completo con rodamientos</p>	<p><i>¡Nuevo!</i></p>  <p><b>5079</b> silentbloc en soporte motor derecho r.o.</p>	<p><i>¡Nuevo!</i></p>  <p><b>5080</b> soporte motor delantero izquierdo r.o. 7765891</p>
<p><i>¡Nuevo!</i></p>  <p><b>5081</b> soporte motor trasero r.o. 46413537-7784343</p>	<p><i>¡Nuevo!</i></p>  <p><b>5082</b> soporte motor derecho 1.7D-TD r.o. 46431619</p>	 <p><b>90010</b> buje rueda delantera de 25 estrías r.o. 7667265</p>
 <p><b>90016</b> buje rueda delantera de 22 estrías r.o. 75608131</p>	 <p><b>90508</b> buje rueda trasera sin Antiskid r.o. 7787124</p>	 <p><b>90523</b> buje rueda trasera con Antiskid r.o. 7766902</p>
<p><b>96020</b> latiguillo freno trasero (218 mm) r.o. 7563852</p>	<p><b>96045</b> latiguillo freno delantero (420 mm) r.o. 7735011</p>	
<p><i>¡Nuevo!</i></p>  <p><b>3752</b> tapa correa distribución 1.1 r.o. 7739437</p>	<p><i>¡Nuevo!</i></p>  <p><b>3753</b> tapa correa distribución 1.2 r.o. 7748306</p>	 <p><b>1115</b> kit fuelle transm. lado rueda GT/TD desde '96, r.o.</p>
 <p><b>1996</b> kit fuelle transmisión lado rueda todos salvo GT/TD, r.o. 7761570</p>	<p><b>1079</b> kit fuelle transmisión lado cambio 55-60-90-75-85-90-D(hasta '97), r.o.</p>	 <p><b>1611</b> kit fuelle transmisión lado cambio GT/TD r.o.</p>



## FIAT PUNTO-I (1993-1999)



**1120**  
kit fuelle transmisión lado cambio TD d/'97  
completo con rodamiento Ø 24,50 mm



**1835**  
fuelle cremallera manual y asistida  
r.o.

**¡Nuevo!**



**4619**  
tapa aluminio en culata Diesel y TurboD  
r.o. 7728241



**2789**  
tapón de bloque de Ø 50 mm  
r.o.

**¡Nuevo!**



**4893**  
tapón de bloque de Ø 51 mm  
r.o. 91600682



**4308**  
polea cigüeñal 1.9 JTD  
r.o. 46780491-60816824-73501275



**2639**  
soporte tubo de escape  
r.o. 7718578



**2638**  
soporte tubo de escape  
r.o. 7740653-7718577



**2742**  
tapón llenado aceite motor (motores de  
gasolina de 8 válvulas), r.o. 7545141



**676**  
tapón cárter de aceite cónico 22x150  
r.o.



**4062**  
tapón cárter de aceite 18x150  
r.o.







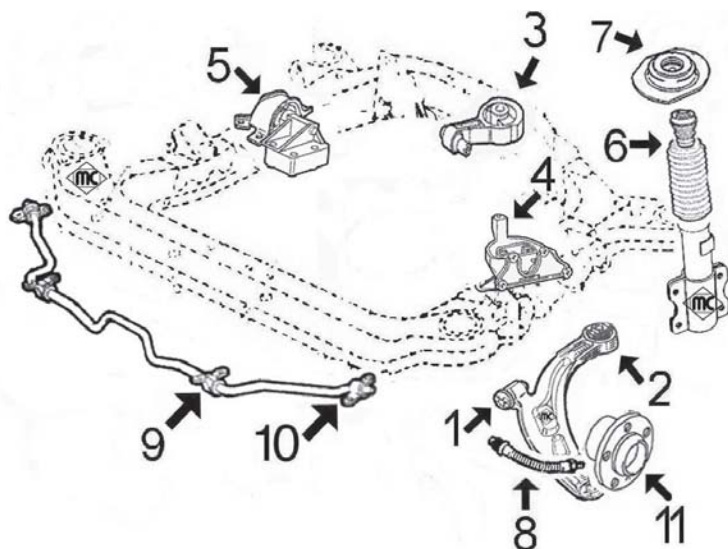







**4126**  
tapón cárter de aceite 20x150  
r.o.

SUSPENSION DELANTERA y SOPORTES DE MOTOR:

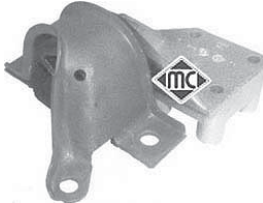

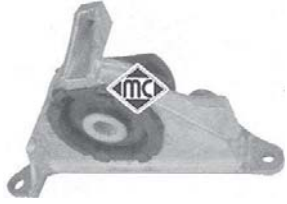
- 1- 4978 silentbloc anterior trapecio delantero
- 2- 4979 silentbloc posterior trapecio delantero
- 3- 4890 soporte motor trasero 1.2
- 4892 soporte motor trasero 1.9D/JTD
- 4- 5085 soporte motor izquierdo 1.2
- 5084 soporte motor izquierdo 1.9D/JTD
- 5- 5067 soporte motor derecho 1.2
- 5083 soporte motor derecho 1.9D/JTD
- 6- n/d capuchón amortiguador delantero
- 7- 4884 soporte amortiguador delantero
- 8- 96050 latiguillo freno delantero (510 mm)
- 9- 2834 goma para barra estabilizadora de 19 mm
- 2835 goma para barra estabilizadora de 21 mm
- 10- 4981 soporte puntal barra estabilizadora
- 11- 90016 buje rueda delantera 1.2-1.9D
- 90010 buje rueda delantera 1.8-1.9JTD

 <p><b>2834</b> goma barra estabilizadora r.o.</p>	 <p><b>2835</b> goma barra estabilizadora r.o.</p>	 <p><b>4884</b> soporte amortiguador delantero r.o.46746544</p>
 <p><b>4890</b> soporte motor trasero 1.2 r.o.46528871</p>	 <p><b>4892</b> soporte motor trasero 1.9D/JTD r.o.46772002</p>	 <p><b>4978</b> silentbloc anterior trapecio delantero r.o.</p>
 <p><b>4979</b> silentbloc posterior trapecio delantero r.o.</p>	 <p><b>4981</b> soporte puntal barra estabilizadora r.o.</p>	 <p><b>5067</b> soporte motor derecho 1.2 r.o.46809632</p>
 <p><b>5083</b> soporte motor derecho 1.9D/JTD r.o.46528850</p>	 <p><b>5084</b> soporte motor izquierdo 1.9D/JTD r.o.46528869</p>	 <p><b>5085</b> soporte motor izquierdo 1.2 r.o.46809633</p>

## FIAT PUNTO-II (1999-2006)

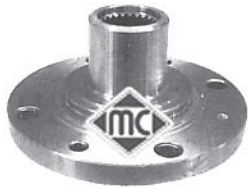

**90010**

buje rueda delantera 1.8-1.9JTD (25 estrías)  
r.o. 7667265

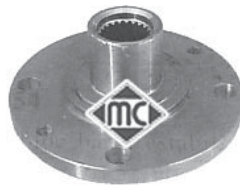

**90016**

buje rueda delantera 1.2-1.9D (22 estrías)  
r.o. 7608131



**96050**

latiguillo freno delantero (480 mm)  
r.o. 46760308



**96051**

latiguillo freno trasero (195 mm)  
r.o. 46542040



**¡Nuevo!**

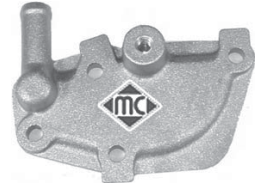

**4619**

tapa aluminio bomba de agua 1.9D/JTD  
r.o. 7728241

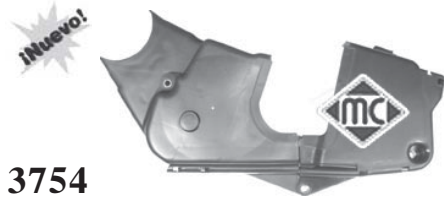

**3754**

cubierta correa distribución 1.2/8v  
r.o. 46542040



**2789**

tapón de bloque de Ø 50 mm  
r.o.

**¡Nuevo!**



**4893**

tapón de bloque de Ø 51 mm  
r.o. 91600682



**5090**

tensor correa alternador 1.2/8v - 1.2/16v  
r.o. 46548452



**4927**

tensor correa alternador 1.9D-JTD desde '02-  
r.o. 55180011

**¡Nuevo!**



**3193**

tubo de agua metálico 1.2 con junta tórica  
r.o. 46527322-73500704-55185418-55185056

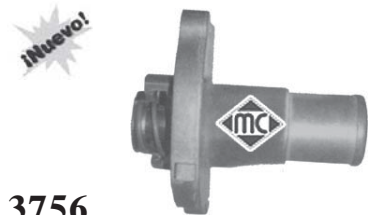

**3756**

tapa con termostato 1.2  
r.o. 7589135



**4894**

polea flexible de alternador  
r.o.



**5001**

polea de alternador de rueda libre  
r.o. 9948225



**1618**

kit fuelle transmisión l/rueda 1.2-1.9D  
r.o.



**1614**

kit fuelle transmisión l/rueda 1.8-1.9JTD  
r.o.



**1079**

kit fuelle transmisión l/cambio 1.2  
r.o.



**1120**

kit fuelle transmisión l/cambio 1.9D (completo  
con rodamiento Ø 24,50 mm), r.o. 46307784



**1611**

kit fuelle transmisión l/cambio 1.8-1.9JTD  
r.o. 4402237

**¡Nuevo!**



**3740**

tapón botella de expansión 1,40 bar  
r.o. 46402982

## FIAT PUNTO-II (1999-2006)

<p><b>¡Nuevo!</b></p>  <p><b>3759</b> botella de expansión 1.8-1.9D/TD r.o. 46745205</p>	 <p><b>1835</b> fuelle cremallera asistida r.o.</p>	 <p><b>1617</b> fuelle cremallera manual r.o.</p>
 <p><b>413</b> cubrepedal freno y embrague r.o. 4170605</p>	 <p><b>2639</b> soporte tubo de escape r.o. 7718578</p>	 <p><b>2638</b> soporte tubo de escape r.o. 7740653-7718577</p>
 <p><b>4062</b> tapón cárter aceite 18x150 r.o.</p>	 <p><b>4126</b> tapón cárter aceite 20x150 r.o.</p>	 <p><b>676</b> tapón cárter aceite cónico 22x150 r.o.</p>
 <p><b>2742</b> tapón llenado aceite motor 1.2/8v r.o. 7545141</p>		



## FIAT REGATA



**5118**

mgto de termostato a bomba 70-85 S  
r.o.4291934

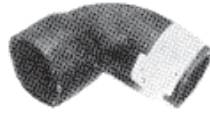

**7354**

mgto de termostato a bomba 1.9Diesel  
r.o.5999905



**3015**

tubo de agua metálico 1.3 - 1.5  
r.o.82378912

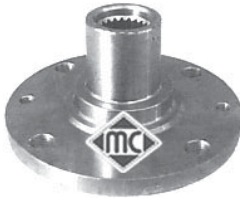

**90002**

buje rueda delantera  
r.o.4390949



**90501**

buje rueda trasera  
r.o.4381043



**459**

silentbloc extremo brazo delantero  
r.o.4402362

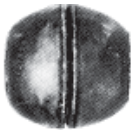

**489**

silentbloc punta tirante brazo delantero  
r.o.4215492-4125489



**230**

silentbloc trapecio trasero  
r.o.



**96017**

latiguillo freno delantero (436 mm)  
r.o.5986578



**280**

soporte tubo de escape  
r.o.5983764



**165**

soporte tubo de escape  
r.o.4387294



**676**

tapón de cárter cónico 22x150  
r.o.

## CANALIZACIONES DE AGUA:

**mgtos. motor 1.9 DS (PSA-XUD) y 1.9 TDS (PSA-XUDTE) (hasta '99)**

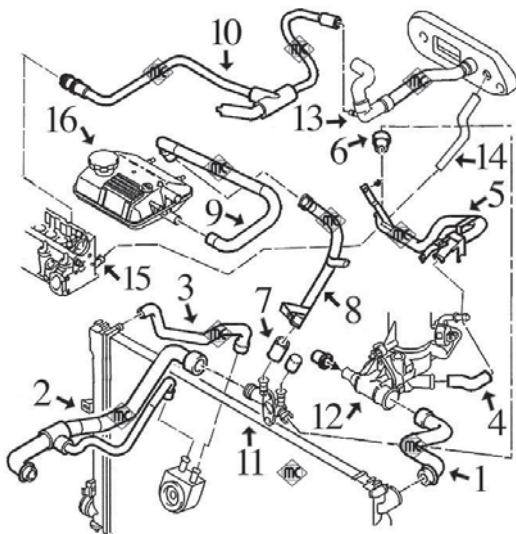

- 1- 8484 mgto superior radiador
- 2- 8483 mgto inferior radiador
- 3- 8489 mgto de radiador a intercambiador
- 4- 8183 mgto de caja termostato a tubo hasta '98  
8480 mgto de caja termostato a tubo desde '98
- 5- 3057 tubo de agua metálico
- 6- 8312 mgto de tubo metálico a racor plástico
- 7- 8488 mgto de racor plástico a tubo metálico
- 8- 3130 tubo metálico de racor plástico a botella
- 9- 8487 mgto de tubo metálico a botella
- 10- 8490 mgto de tubo de calefacción a culata, TurboDiesel
- 11- 3503 racor plástico conexión mgtos.
- 12- 3546 tapa de termostato  
3171 boquilla metálica en caja de termostato
- 13- 8485 mgto dcho. calefactor
- 14- 8486 mgto izqdo. calefactor
- 15- 3059 boquilla en culata
- 16- 3741 botella de expansión  
3547 tapón botella expansión 1.0 bar

**mgtos. motor 1.9DS (PSA-DW8 desde '99)**

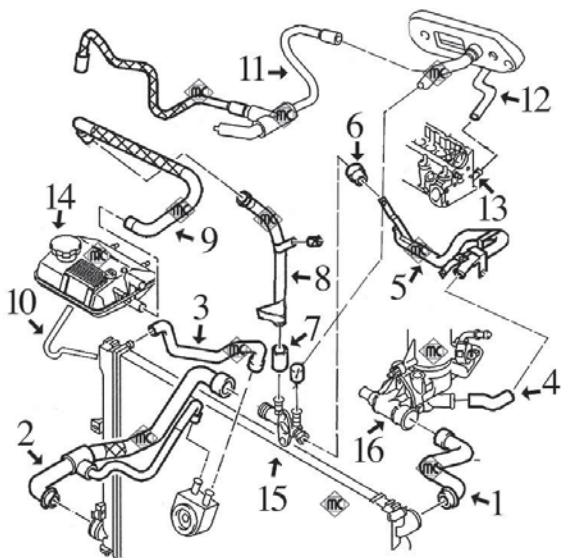

- 1- 8564 mgto superior radiador
- 2- 8557 mgto inferior radiador
- 3- 8556 mgto de radiador a intercambiador hasta '00  
8558 mgto de radiador a intercambiador desde '00
- 4- 8480 mgto de caja termostato a tubo
- 5- 3129 tubo de agua metálico
- 6- 8312 mgto de tubo metálico a racor plástico
- 7- 8488 mgto de racor plástico a tubo metálico hasta '00
- 8- 3138 tubo metálico de racor plástico a botella hasta '00
- 9- 8561 mgto de tubo metálico a botella hasta '00  
8562 mgto de tubo metálico a botella desde '00
- 10- 8563 mgto de botella a radiador
- 11- 8559 mgto de calefactor a botella
- 12- 8560 mgto de calefactor a culata
- 13- 3059 boquilla en culata
- 14- 3741 botella de expansión hasta 6/'00  
3742 botella de expansión desde 6/'00  
3547 tapón botella expansión 1.0 bar
- 15- 3544 racor plástico conexión manguitos
- 16- 3539 tapa de termostato  
3171 boquilla metálica en caja de termostato

**mgtos. motor 2.0JTD (PSA-HDi)**

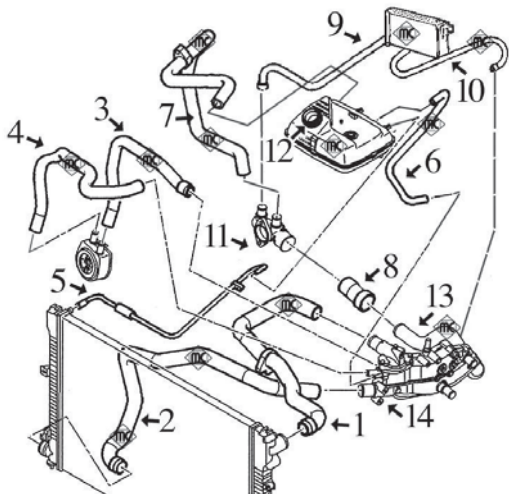

- 1- 8598 mgto superior radiador
- 2- 8597 mgto inferior radiador
- 3- 8585 mgto de intercambiador a caja termostato
- 4- 8596 mgto de intercambiador a caja termostato
- 5- 8592 mgto de botella a radiador
- 6- 8591 mgto de botella a caja termostato
- 7- 8595 mgto de racor plástico a botella
- 8- 8587 mgto de tubo metálico a racor plástico
- 9- 8593 mgto derecho calefactor
- 10- 8594 mgto izquierdo calefactor
- 11- 3554 racor plástico conexión manguitos
- 12- 3742 botella de expansión  
3547 tapón botella expansión 1.0 bar
- 13- 3139 tubo metálico con junta tórica
- 14- 3135 tapa de termostato (aluminio)  
3556 tapa de termostato (plástico)

## FIAT SCUDO - ULYSSE



**8183**

mgto de caja termostato a tubo 1.9D h/'98  
r.o. 1307.W3



**8312**

mgto de tubo metálico a racor plástico  
r.o. 1307.W4



**8480**

mgto de caja termostato a tubo  
r.o.



**8483**

mgto inferior radiador 1.9 D  
r.o.



**8484**

mgto superior radiador 1.9 D  
r.o.



**8485**

mgto derecho calefactor 1.9 D  
r.o.



**8486**

mgto izquierdo calefactor 1.9 D  
r.o.



**8487**

mgto de tubo metálico a botella  
r.o.



**8488**

mgto de racor plástico a tubo metálico  
r.o.



**8489**

mgto de radiador a intercambiador  
r.o.



**8490**

mgto de tubo calefacción a culata 1.9 TD  
r.o.



**8556**

mgto de radiador a intercambiador  
r.o.



**8557**

mgto inferior radiador 1.9 DW8  
r.o.



**8558**

mgto de radiador a intercambiador  
r.o.



**8559**

mgto de calefactor a botella  
r.o.



**8560**

mgto de calefactor a culata  
r.o.



**8561**

mgto de tubo metálico a botella  
r.o.



**8562**

mgto de tubo metálico a botella  
r.o.



**8563**

mgto de botella a radiador  
r.o.



**8564**

mgto superior radiador 1.9 DW8  
r.o.



**8585**

mgto de intercambiador 2.0 HDi  
r.o.

## FIAT SCUDO - ULYSSE



**8587**  
mgto de tubo metálico a racor plástico HDi  
r.o.



**8591**  
mgto de botella a caja termostato HDi  
r.o.



**8592**  
mgto de botella a radiador HDi  
r.o.



**8593**  
mgto derecho calefactor HDi  
r.o.



**8594**  
mgto izquierdo calefactor HDi  
r.o.



**8595**  
mgto de botella a racor plástico  
r.o.



**8596**  
mgto de intercambiador a caja termostato  
r.o.



**8597**  
mgto inferior radiador 2.0 HDi  
r.o.



**8598**  
mgto superior radiador 2.0 HDi  
r.o.



**3057**  
tubo de agua metálico 1.9 D y TD  
r.o. 1307.W2



**3059**  
boquilla en culata 1.9 Diesel todos  
r.o. 0245.42-0245.44



**3078**  
boquilla en caja termostato 1.8 gasolina  
r.o. 1336.K8



**3129**  
tubo de agua metálico 1.9 DW8  
r.o. 1307.NY



**3130**  
tubo de agua metálico a botella 1.9 D  
r.o. 1307.AY



**3135**  
tapa de termostato 2.0 HDi (aluminio)  
r.o. 1336.P2



**3138**  
tubo de agua metálico 1.9 DW8  
r.o. 1307.PH



**3139**  
tubo de agua metálico 2.0 HDi con junta  
r.o. 1307.YZ



**3171**  
boquilla en caja termostato 1.9D-TD (XU)  
r.o. 1336.N7



**3503**  
racor conexión mgto 1.9 Diesel hasta '99  
r.o. 1336.G4

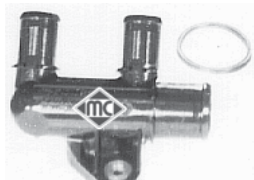

**3523**  
racor conexión mgto 1.8 gasolina  
r.o. 1336.H7



**3538**  
tapa de termostato 1.8 gasolina (XU7)  
r.o. 1336.A1



## FIAT SCUDO - ULYSSE



**3539**  
tapa de termostato 1.9 DW8  
r.o. 1336.C9



**3544**  
racor conexión mgts 1.9 Diesel DW8  
r.o. 1336.P0-1336.Q3



**3546**  
tapa de termostato 1.9 Diesel  
r.o. 1336.G3



**3547**  
tapón botella expansión 1.0 bar  
r.o. 1336.E0-1336.C6



**3554**  
racor conexión mgts 2.0 HDi  
r.o.



**3556**  
tapa de termostato 2.0 HDi (plástico)  
r.o. 1336.R9

**¡nuevo!**



**3741**  
botella de expansión 1.6-1.8 gasolina y 1.9D  
hasta 6/00, r.o. 1307.RH-1307.RJ

**¡nuevo!**



**3742**  
botella de expansión 1.9D desde 6/00, 2.0  
gasolina y 2.0 HDi, r.o. 1307.ST

mgtos. DESVAPORIZADORES 1.9 Diesel-XUD9 y XUD9TE:

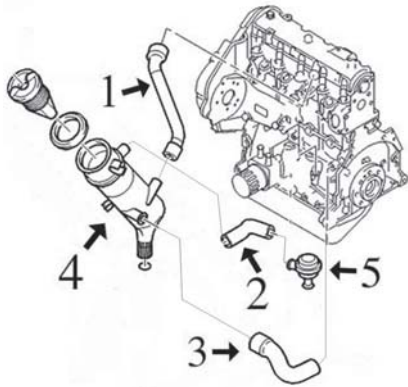

- 1- 8307 mgto de tapa balancines a decantador motores XUD
- 2- 8167 mgto de decantador a válvula motor 1.9D-XUD
- 3- 8166 mgto de bloque a decantador motor 1.9D-XUD9
- 8491 mgto de bloque a decantador motor 1.9TD-XUD9TE
- 4- 3631 decantador completo con tapón 1.9D-XUD
- 5- 3637 válvula desvaporizadora 1.9D-XUD

mgtos. DESVAPORIZADORES 1.9 Diesel DW8:

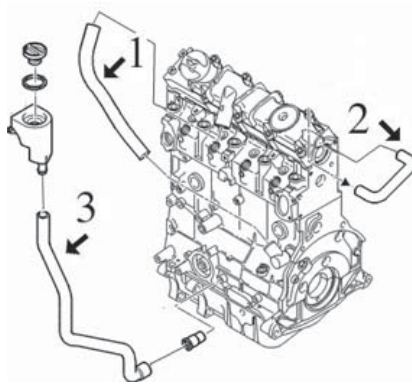

- 1- 8474 mgto de tapa balancines a colector motor 1.9 DW8
- 2- 8475 mgto de bloque a culata motor 1.9 DW8
- 3- n/d mgto de cárter a regulador



**8166**  
mgto desvaporizador 1.9 D y TD  
r.o. 1192.48



**8167**  
mgto desvaporizador 1.9 D y TD  
r.o. 1180.A3



**8307**  
mgto desvaporizador 1.9 D y TD  
r.o. 1180.86



**8474**  
mgto desvaporizador 1.9DW8  
r.o. 1180.G4



**8475**  
mgto desvaporizador 1.9DW8  
r.o. 1180.G5



**8491**  
mgto desvaporizador 1.9 TD (XUDTE)  
r.o.



**3631**  
decantador completo con tapón  
r.o. 1180.95



**3637**  
válvula desvaporizadora 1.9D-TD  
(motores XUD), r.o. 0361.58



**4490**  
soporte decantador motor 1.8 XU7  
r.o. 1439.10

## SUSPENSION DELANTERA y SOPORTES DE MOTOR MOTORES DE GASOLINA 1.6 (FIAT 1580 SPi) - 1.8 (PSA-XU7) y 2.0 (PSA-EW10)

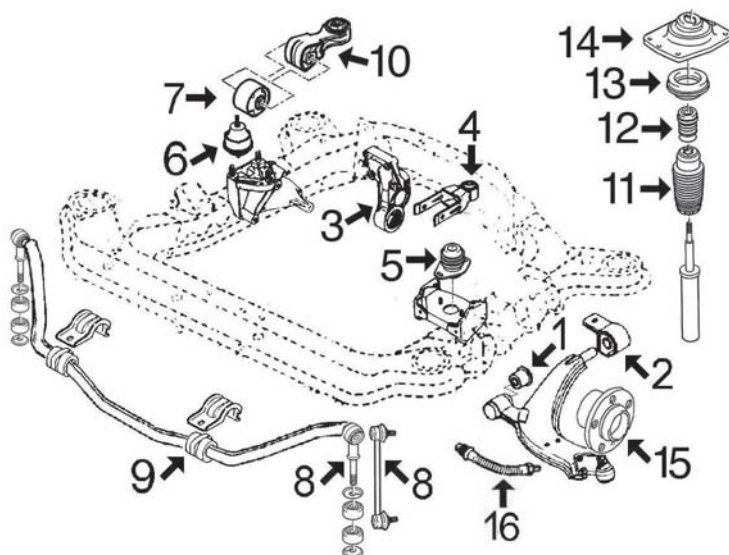

- 1- 2981 silentbloc anterior trapecio delantero
- 2- 2982 silentbloc posterior trapecio delantero izquierdo
- 2983 silentbloc posterior trapecio delantero derecho
- 3- 2869 silentbloc soporte posterior motor 1.6-1.8
- 2966 silentbloc soporte posterior motor 2.0
- 4- 4744 tirante trasero de motor completo
- 877 silentbloc en tirante posterior de motor
- 5- 2794 soporte izquierdo motor, cambio manual
- 2943 soporte izquierdo motor, cambio automático
- 6- 2924 soporte derecho motor 1.6-1.8
- 2942 soporte derecho motor 2.0
- 7- 2869 silentbloc soporte bieleta antipar
- 8- 2948 bieleta puntal barra estabilizadora Scudo todos y Ulysse hasta -'02
- 5055 bieleta puntal barra estabilizadora Ulysse desde '02-
- 9- 2945 goma soporte barra estabilizadora
- 10- 4744 bieleta antipar 1.8 (XU7)
- 4486 bieleta antipar 2.0 (EW10)
- n/d bieleta antipar 1.6
- 11- 4196 capuchón amortiguador delantero
- 12- n/d tope poliuretano
- 13- 4206 rodamiento
- 14- 2947 soporte amortiguador izquierdo, dirección asistida
- soporte amortiguador derecho, dirección manual
- 2946 soporte amortiguador derecho, dirección asistida
- soporte amortiguador izquierdo, dirección manual
- 15- 90038 buje rueda delantera
- 16- 96032 latiguillo freno delantero (515 mm)

## SUSPENSION DELANTERA y SOPORTES DE MOTOR MOTORES DIESEL 1.9 D (XUD y DW8) y 2.0 HDi (DW10)

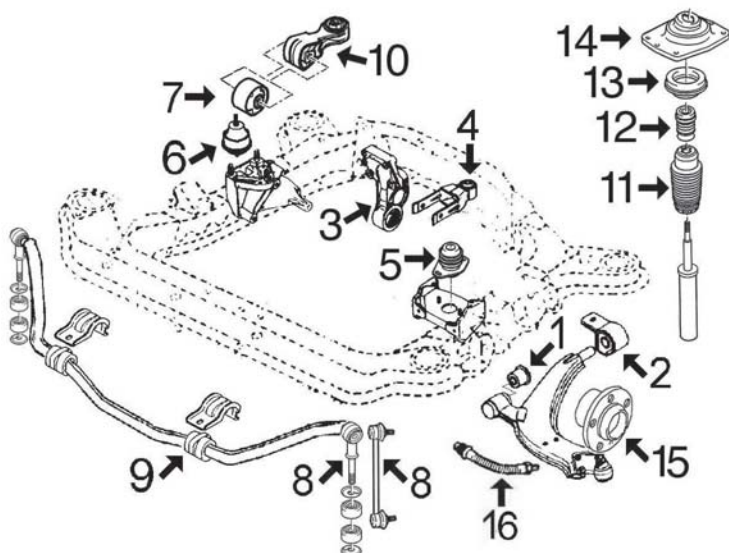

- 1- 2981 silentbloc anterior trapecio delantero
- 2- 2982 silentbloc posterior trapecio delantero izquierdo
- 2983 silentbloc posterior trapecio delantero derecho
- 3- 2980 silentbloc soporte posterior motor 1.9 Diesel-XUD, 1.9 Diesel-DW8
- 2966 silentbloc soporte posterior motor 2.0 HDi
- 4- 4744 tirante trasero de motor completo
- 877 silentbloc en tirante posterior de motor
- 5- 2794 soporte izquierdo motor 1.9 Diesel XUD y DW8
- 2943 soporte izquierdo motor 2.0 HDi
- 6- 2924 soporte derecho motor 1.9 Diesel-XUD
- 2942 soporte derecho motor 1.9 Diesel-DW8
- 2944 soporte derecho motor 2.0 HDi
- 7- 2869 silentbloc soporte bieleta antipar hasta 6/'01 (desde 6/'01 incorporado en bieleta MC-4005)
- 8- 2948 bieleta puntal barra estabilizadora Scudo todos y Ulysse hasta -'02
- 5055 bieleta puntal barra estabilizadora Ulysse desde '02-
- 9- 2945 goma soporte barra estabilizadora
- 10- 4744 bieleta antipar 1.9D-TD-DW8 y 2.0 HDi hasta 6/'01
- 4005 bieleta antipar 1.9DW8 y 2.0 HDi desde 6/'01
- 11- 4196 capuchón amortiguador delantero
- 12- n/d tope poliuretano
- 13- 4206 rodamiento
- 14- 2947 soporte amortiguador izquierdo, dirección asistida
- soporte amortiguador derecho, dirección manual
- 2946 soporte amortiguador derecho, dirección asistida
- soporte amortiguador izquierdo, dirección manual
- 15- 90038 buje rueda delantera
- 16- 96032 latiguillo freno delantero (515 mm)

## FIAT SCUDO - ULYSSE

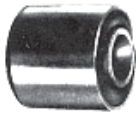

**877**  
silentbloc tirante posterior motor  
r.o.1809.04(12x30x28x34)



**2794**  
soporte izquierdo motor  
r.o.1844.36-1827.10



**2869**  
silentbloc soporte trasero motor  
r.o.1809.16



**2924**  
soporte motor derecho 1.6-1.8 y 1.9D  
r.o.1827.14-1827.26



**2942**  
soporte motor derecho 2.0 gasolina y 1.9DW  
r.o.1844.92



**2943**  
soporte motor izquierdo 2.0 HDi y automat.  
r.o.1827.16



**2944**  
soporte motor derecho 2.0 HDi  
r.o.1827.33



**2945**  
goma barra estabilizadora  
r.o.5094.69



**2946**  
soporte amortiguador Dcho-Izqdo.  
r.o.5038.17



**2947**  
soporte amortiguador Dcho-Izqdo.  
r.o.5038.16



**2948**  
bieleta puntal barra estabilizadora completa  
Scudo todos y Ulysse hasta '02,r.o. 5087.35



**2949**  
silentbloc **brazo trasero** de suspensión  
r.o.5152.61(12x46x48x60)



**2966**  
silentbloc soporte motor trasero 2.0 HDi  
r.o.1809.30



**2980**  
silentbloc soporte motor trasero 1.9 D  
r.o.1809.21



**2981**  
silentbloc anterior trapecio delantero  
r.o. no hay despiece



**2982**  
silentbloc posterior trapecio delt. izquierdo  
r.o. no hay despiece



**2983**  
silentbloc posterior trapecio delt. derecho  
r.o. no hay despiece



**4005**  
bieleta tirante derecho motor (antipar)  
r.o.1806.28

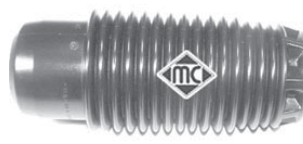

















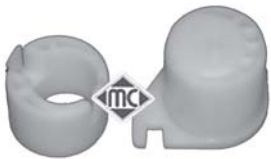



**4196**  
capuchón amortiguador delantero  
r.o.5254.19



**4206**  
rodamiento en soporte amortiguador  
r.o.5035.43



## FIAT SCUDO - ULYSSE

<p><b>¡Nuevo!</b></p>  <p><b>4486</b> bieleta tirante de reacción motor 1.8-2.0 gasolina, r.o. 1806.34</p>	<p><b>¡Nuevo!</b></p>  <p><b>4744</b> bieleta tirante reacción y tirante trasero completo, r.o.</p>	<p><b>¡Nuevo!</b></p>  <p><b>5055</b> bieleta puntal barra estabilizadora Ulysse desde '02-, r.o. 5087.51</p>
 <p><b>900038</b> bujes rueda delantera r.o. 3307.64</p>	 <p><b>96032</b> latiguillo freno delantero (515 mm) r.o. 4806.82</p>	 <p><b>96167</b> latiguillo freno trasero (275 mm) r.o. 4806.67</p>
 <p><b>4159</b> bieleta mando cambio, rótulas de Ø 13 mm (extensible de 75 a 105 mm) r.o.</p>	 <p><b>4043</b> juego casquillos horquilla embrague motores XU y DW, r.o. 2175.20 - 2175.21</p>	 <p><b>4052</b> horquilla embrague completa con casquillos motores XU y 1.9DW8, r.o. 2115.25</p>
<p><b>¡Nuevo!</b></p>  <p><b>4605</b> casquillo guía embrague con retén r.o. 2105.35</p>	 <p><b>4066</b> horquilla embrague motor 1.9DW8 y 2.0HDi r.o. 2117.58</p>	<p><b>¡Nuevo!</b></p>  <p><b>4799</b> horquilla embrague motor 2.1TD y 2.0HDi completa con casquillos, r.o. 2117.59</p>
<p><b>¡Nuevo!</b></p>  <p><b>4562</b> polea cigueñal 2.0 gasolina-EW10 d/'01 r.o. 0515.R1</p>	<p><b>¡Nuevo!</b></p>  <p><b>4485</b> polea cigueñal 1.8 gasolina (XU7) r.o. 0515.H6</p>	<p><b>¡Nuevo!</b></p>  <p><b>4443</b> polea cigueñal 2.0 gasolina-EW10 hasta '01 r.o. 0515.N3</p>
 <p><b>2926</b> polea cigueñal 1.9 D (XUD, hasta '98) r.o. 0515.G3</p>	 <p><b>2927</b> polea cigueñal 1.9 DW8 sin aire acond. r.o. 0515.Q6</p>	 <p><b>2928</b> polea cigueñal 1.9DW8-2.0HDi hasta 10/'04 r.o. 0515.P2</p>
<p><b>¡Nuevo!</b></p>  <p><b>4477</b> polea cigueñal 1.9DW8-2.0HDi desde 10/'04 r.o. 0515.S4</p>	<p><b>¡Nuevo!</b></p>  <p><b>4738</b> polea cigueñal 2.0HDi/16v r.o. 0515.R9</p>	<p><b>¡Nuevo!</b></p>  <p><b>4479</b> soporte tapa cubre motor 2.0HDi r.o. 0137.11-0137.23</p>

## FIAT SCUDO - ULYSSE

<p><b>¡Nuevo!</b></p>  <p><b>3642</b> tapón llenado aceite 1.9DW8-2.0HDi r.o. 1180.F9</p>	<p><b>¡Nuevo!</b></p>  <p><b>4612</b> varilla nivel aceite 1.9D-TD (XUD) r.o. 1174.15</p>	 <p><b>1370</b> fuelle cremallera dirección dcho. e izqd. r.o. 4066.41</p>
 <p><b>1996</b> kit rep. transmisión l/rda 1.6 - 1.8 (cambio BE3) r.o. 3293.01</p>	 <p><b>1520</b> kit rep. transmisión l/rda 1.6 - 1.8 (cambio BE3R) r.o. 3293.96</p>	 <p><b>1222</b> kit rep. transmisión l/rda 1.9 Diesel r.o. 3293.02</p>
 <p><b>1217</b> kit rep. transmisión l/rda Turbo D r.o. 3293.00</p>	 <p><b>1499</b> kit rep. transmisión l/rda 2.0 HDi r.o.</p>	 <p><b>1362</b> kit rep. transmisión l/cbo. todos salvo 1.9D r.o. 3287.79</p>
 <p><b>1213</b> kit rep. transmisión l/cbo. 1.9 Diesel r.o. 3287.81</p>	<p><b>¡Nuevo!</b></p>  <p><b>4564</b>      Ø 30/47 y 40/58 mm juego retenes diferencial-transmisión (cambio BE3-BE4), r.o. 3121.44+3121.46</p>	<p><b>¡Nuevo!</b></p>  <p><b>4620</b>      Ø 32/50 y 40/58 mm juego retenes diferencial-transmisión (cambio ME-ML5T), r.o. 3121.44+3121.24</p>
<p><b>¡Nuevo!</b></p>  <p><b>3651</b> tapa filtro gasoil 1.9 DW8 con junta y clip de cierre, r.o. 1904.26+1904.27</p>	 <p><b>2931</b> tensor correa alternador completo 1.9D r.o. 5751.81</p>	<p><b>¡Nuevo!</b></p>  <p><b>3698</b> juego tapas correa distribución 1.9D -'99 (XUD), r.o. 0320.H2/H3/F9</p>
<p><b>¡Nuevo!</b></p>  <p><b>3700</b> juego tapas correa distribución 1.9D '99- (DW8), r.o. 0320.N3/X6/N4</p>	<p><b>¡Nuevo!</b></p>  <p><b>3699</b> juego tapas correa distribución 2.0HDi (DW10), r.o. 0320.N5/N6/S7</p>	<p><b>¡Nuevo!</b></p>  <p><b>5043</b> tensor correa alternador 1.9 DW8 sin A/C r.o. 5751.74</p>
<p><b>¡Nuevo!</b></p>  <p><b>4609</b> tensor correa alternador 1.9 D r.o. 5751.38</p>	<p><b>¡Nuevo!</b></p>  <p><b>4826</b> tensor correa alternador 1.9 D-TD-DW8 r.o. 5751.30</p>	<p><b>¡Nuevo!</b></p>  <p><b>4807</b> tensor correa alternador 2.0HDi r.o. 5751.55</p>

## FIAT SCUDO - ULYSSE

<p><b>¡Nuevo!</b></p>  <p><b>4929</b>      <math>\text{Ø } 17 \times 90 \text{ mm}</math> rodillo tensor correa alternador 1.8 con A/C r.o. 5751.20</p>	<p><b>¡Nuevo!</b></p>  <p><b>4895</b> tensor correa alternador 1.8 con A/C r.o. 5751.35</p>	<p><b>¡Nuevo!</b></p>  <p><b>4995</b> rodillo tensor correa alternador 1.9DW8-2.0HDi con A/C, r.o. 5751.29</p>
<p><b>¡Nuevo!</b></p>  <p><b>4996</b> rodillo tensor correa alternador 2.0HDi sin A/C, r.o. 5751.96-5751.57</p>	<p><b>¡Nuevo!</b></p>  <p><b>4928</b> rodillo tensor correa alternador 1.9DW8 sin A/C, r.o. 5751.73</p>	<p><b>¡Nuevo!</b></p>  <p><b>4915</b>      <math>\text{Ø } 54,60 \text{ mm}</math> polea de alternador de rueda libre r.o.</p>
<p><b>¡Nuevo!</b></p>  <p><b>4916</b>      <math>\text{Ø } 58,50 \text{ mm}</math> polea de alternador de rueda libre r.o.</p>	<p><b>¡Nuevo!</b></p>  <p><b>2938</b>      junta de <math>\text{Ø } 58 \times 45 \text{ mm}</math> kit montaje colector escape 1.9 D (DW8) r.o.</p>	<p><b>¡Nuevo!</b></p>  <p><b>2940</b>      junta de <math>\text{Ø } 80 \times 66 \text{ mm}</math> kit montaje colector escape 1.6-1.8 gasolina r.o.</p>
 <p><b>2951</b>      junta de <math>\text{Ø } 71 \times 58 \text{ mm}</math> kit montaje colector escape 1.9 TD (XUD9TE) r.o.</p>	 <p><b>2952</b>      junta de <math>\text{Ø } 60 \times 46 \text{ mm}</math> kit montaje colector escape 1.9 D (XUD9) r.o.</p>	 <p><b>2950</b>      junta de <math>\text{Ø } 78 \times 66 \text{ mm}</math> kit montaje colector escape 2.0 HDi r.o.</p>
 <p><b>2753</b> soporte tubo de escape r.o. 1755.69-1755.63</p>	 <p><b>2754</b> soporte tubo de escape r.o. 1755.62</p>	 <p><b>2770</b> cubrepedal freno r.o. 4504.12</p>
 <p><b>2771</b> cubrepedal embrague r.o. 2130.13</p>	 <p><b>2772</b> cubrepedal acelerador r.o. 1604.07</p>	 <p><b>2452</b> tapón cárter de aceite 14 x 125 r.o. 0311.21</p>
 <p><b>2929</b> tapón cárter de aceite 10 x 125, 1.9 Diesel desde '99, r.o. 0311.29</p>	 <p><b>2050</b> arandela tapón de cárter metaloplástica (14x22), r.o. 0313.27</p>	 <p><b>2051</b> arandela tapón de cárter plana 10 x 21 mm r.o. 0313.33</p>



## CANALIZACIONES DE AGUA

**TIPO - TEMPRA 1.4 - 1.6 (gasolina)**

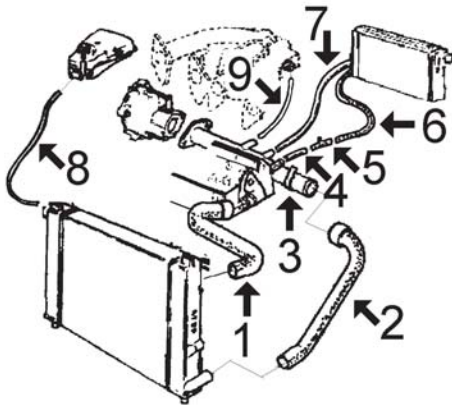

- 1- 8054 mgto superior radiador
- 2- 8055 mgto inferior radiador
- 3- 3021 tubo de agua metálico
- 4- 118 tubo de boquilla en culata a purgador: Cortar de rollo MC-118 Ø 13x20 mm longitud 9 cms
- 5- 971 purgador circuito agua
- 6- 118 mgto de calefactor a purgador: Cortar de rollo MC-118 Ø 13x20 mm longitud 45 cms
- 7- n/d mgto de calefactor a tubo metálico
- 8- 117 mgto de botella a radiador: Cortar de rollo MC-117 Ø 10x17 mm, longitud 95 cms
- 9- 117 mgto de tubo metálico a colector: Cortar de rollo MC-117 Ø 10x17 mm, longitud 25 cms

**TIPO - TEMPRA 1.9 Diesel:**

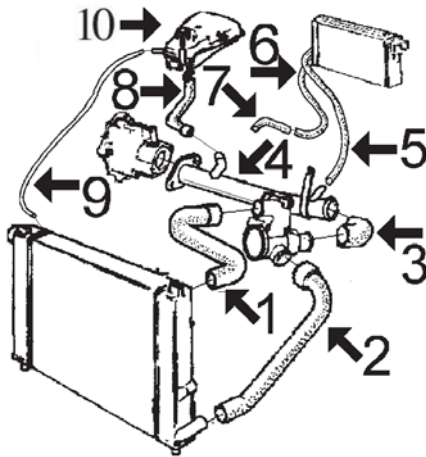

- 1- 8056 mgto superior de radiador
  - 2- 8057 mgto inferior de radiador
  - 3- 7354 mgto de termostato a tubo metálico Diesel
  - 8467 mgto de termostato a tubo metálico TurboD
  - 4- 3098 tubo de agua metálico
  - 5- n/d mgto de calefactor a tubo metálico
  - 6- n/d mgto de calefactor a culata, 1er. tramo
  - 7- n/d mgto de calefactor a culata, 2º tramo
  - 8- n/d mgto de botella a tubo metálico
  - 9- 117 mgto de sobrante de botella a radiador: Cortar de rollo MC-117 Ø 10x17 mm, long. 95 cms
  - 10- 3533 botella de expansión
  - 3740 tapón botella de expansión 1,4 bar
  - 3572 tapón botella de expansión 1,0 bar
- n/d no disponible



**8054**  
mgto superior radiador 1.4-1.6  
r.o. 7609904



**8055**  
mgto inferior radiador 1.4-1.6  
r.o. 7609905



**8056**  
mgto superior radiador Diesel y TD  
r.o. 7603601



**8057**  
mgto inferior radiador Diesel y TD  
r.o. 7603602



**7354**  
mgto de termostato a tubo Diesel  
r.o. 5999905

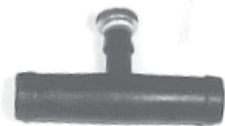

**971**  
purgador circuito de agua 1.4-1.6  
r.o.



**3021**  
tubo de agua metálico, 1.4-1.6  
r.o. 7596811



**3098**  
tubo de agua metálico 1.9 Diesel  
r.o. 7784387



**3533**  
botella de expansión Diesel  
r.o. 92517058



## FIAT TIPO - TEMPra



**8319**  
mgto desvaporizador  
r.o.



**4206**  
rodamiento soporte amortiguador delantero  
r.o. 1303672080



**2344**  
soporte motor trasero 1.4-1.6-Diesel  
r.o. 762902-7652240-7642540



**890**  
soporte motor derecho gasolina y Diesel  
r.o. 7610157

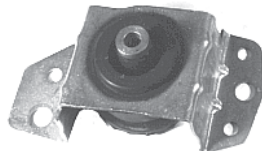

**2343**  
soporte motor delantero derecho 1.4-1.6  
r.o. 7610541

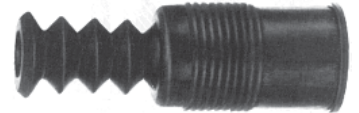

**2345**  
capuchón amortiguador delantero  
r.o. 7607086



**4011**  
casquillo plástico reenvío mando cambio  
r.o. 4259848

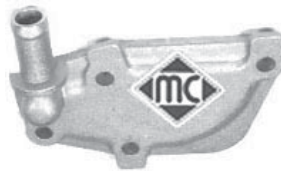

**3141**  
tapa aluminio en culata  
r.o. 5932811



**4268**  
horquilla embrague  
r.o. 7617578



**1618**  
kit rep. transmisión l/rueda todos salvo TD  
r.o. 7635255



**1619**  
kit rep. transmisión l/rueda TurboDiesel  
r.o. 8243745



**583**  
fuelle transmisión lado cambio  
r.o.



**1583**  
kit rep. transmisión l/cambio completo con  
rodamiento, r.o. 7625541



**1835**  
fuelle cremallera asistida  
r.o.

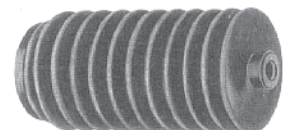

**1617**  
fuelle cremallera dirección manual  
r.o. 7566840



**2675** Ø 19,9 mm  
silentbloc anterior brazo suspensión delt.  
(hasta '90), r.o. no hay despiece



**2674** Ø 19,9 mm  
silentbloc posterior **brazo izquierdo** delt.  
(hasta '90), r.o. no hay despiece



**2673** Ø 19,9 mm  
silentbloc posterior **brazo derecho** delt.  
(hasta '90), r.o. no hay despiece



**2899** Ø 20,9 mm  
silentbloc anterior brazo suspensión delt.  
(desde '90), r.o. no hay despiece



**2900** Ø 20,9 mm  
silentbloc posterior **brazo izquierdo** delt.  
(desde '90), r.o. no hay despiece



**2901** Ø 20,9 mm  
silentbloc posterior **brazo derecho** delt.  
(desde '90), r.o. no hay despiece

## FIAT TIPO - TEMPRA



**2637**  
bioleta puntal barra estabilizadora completa  
r.o. 7601647+7601642



**3572**  
tapón botella expansión 1.0 bar  
r.o. 1306.E1



**3740**  
tapón botella expansión 1.4 bar  
r.o. 46402982



**2741**  
goma barra estabilizadora  
r.o. 7635714



**2700**  
soporte carburador  
r.o. 7685482



**2742**  
tapón llenado aceite motor  
r.o. 7713649



**083**  
soporte tubo de escape Diesel  
r.o. 7664624



**094**  
soporte tubo de escape 1.4-1.6  
r.o. 7600807



**127**  
soporte tubo de escape 1.4-1.6  
r.o. 7637572



**057**  
soporte tubo de escape 1.4-1.6  
r.o. 5989798



**2636**  
soporte tubo de escape Diesel desde '93  
r.o. 7749062



**2919**  
kit reparación brazo suspensión trasero  
completo con rodamientos



**96022**  
latiguillo freno delantero (405 mm)  
r.o. 7655156



**96024**  
latiguillo freno trasero (245 mm)  
r.o. 7619751



**90016**  
buje rueda delantera salvo 1.9TurboD  
(22 estrías), r.o. 7608131



**90010**  
buje rueda delantera 1.9 TurboDiesel  
(25 estrías), r.o. 7667265

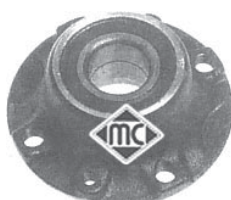

**90508**  
buje rueda trasera sin "Antiskid" (ABS)  
r.o. 7787124



**90509**  
buje rueda trasera con "Antiskid" (ABS)  
r.o. 60811481



**3757**  
caja completa con termostato 1.7D-1.9D  
r.o. 7625346

r.o.

r.o. 46402982

## FIAT UNO - FIORINO



**5700**  
mgto superior radiador 45-45 S  
r.o. 5953049



**5702**  
mgto superior radiador 55-70-70 S  
r.o. 5938965



**7336**  
mgto calefactor todos modelos  
r.o.



**5703**  
mgto inferior radiador 55-70-70 S  
r.o. 5938966



**8174**  
mgto inferior radiador 1.0/1.1 FIRE  
r.o. 7568331



**8175**  
mgto superior radiador 1.0/1.1 FIRE  
r.o. 7559884



**8052**  
mgto inferior radiador 1.7 Diesel y TD  
r.o. 7570385



**8053**  
mgto superior radiador 1.7 Diesel y TD  
r.o. 7570384



**3021**  
tubo de agua metálico UNO 1.4 desde '89  
r.o. r.o. 7596811



**3015**  
tubo de agua 55-70 hasta '89  
r.o. 82378912



**3007**  
tubo de agua 45 hasta '89  
r.o. 4257466-5399571



**3128**  
boquilla en culata motor FIRE  
r.o. 7747183



**3097**  
tubo de agua metálico 1.3 TurboDiesel  
r.o. 7784785



**3098**  
tubo de agua 1.9 Diesel  
r.o. 5996758



**3038**  
tubo de agua 1.0/1.1 FIRE con junta tórica  
r.o. 7545122

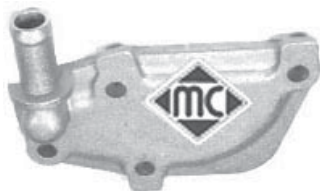

**3141**  
tapa aluminio en culata  
r.o. 5932811

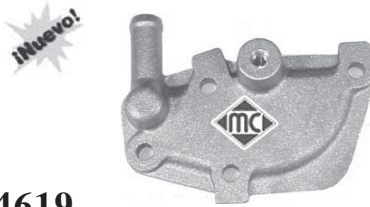

**4619**  
tapa aluminio en culata  
r.o. 7728241



**2836**  
boquilla 3 vias con purgador  
r.o. 7537069



**2837**  
boquilla 4 vias, motores Fire  
r.o. 7603190



**3531**  
botella de expansión Diesel hasta '89  
r.o. 5981712



**3532**  
botella de expansión Diesel desde '89  
r.o. 7765020



## FIAT UNO - FIORINO

 <p><b>3750</b> cubierta tapa distribución (una pieza) r.o. 7656118</p>	 <p><b>3751</b> jgo. cubierta tapa distribución (dos piezas) r.o. 7752155-7752153</p>	 <p><b>478</b> juego casquillos palanca de cambio h/ '88</p>
 <p><b>957</b> juego casquillos palanca de cambio d/ '88 r.o.</p>	 <p><b>715</b> capuchón amortiguador delantero r.o. 5978771</p>	 <p><b>4205</b> soporte amortiguador delantero r.o. 5968311</p>
 <p><b>486</b> silentbloc anterior trapecio delantero r.o. 5927292</p>	 <p><b>487</b> silentbloc posterior trapecio delantero r.o. 5927293</p>	 <p><b>2670</b> goma central barra estabilizadora r.o. 7563151</p>
 <p><b>660</b> soporte trasero derecho motor 45-55-70-Fire r.o. 5974775</p>	 <p><b>662</b> soporte delantero motor 45-55-70-Fire r.o. 5937315</p>	 <p><b>836</b> soporte trasero izquierdo motor 45-55-70 y Fire, r.o. 5974777-7589253</p>
 <p><b>2908</b> soporte delantero motor 1.7Diesel-1.9Diesel r.o. 7622921</p>	 <p><b>2907</b> <b>hidráulico</b> soporte motor trasero derecho 1.7D-1.9D r.o. 7589520</p>	 <p><b>886</b> soporte trasero izquierdo motor 1.7D-1.9D r.o. 7571214</p>
 <p><b>661</b> soporte superior amortiguador trasero r.o. 5960254</p>	 <p><b>257</b> fuelle derecho cremallera r.o. 7583243</p>	 <p><b>258</b> fuelle izquierdo cremallera r.o. 7583242</p>
 <p><b>245</b> goma varilla nivel aceite r.o.</p>	 <p><b>289</b> casquillo cremallera dirección r.o.</p>	 <p><b>2742</b> tapón llenado aceite r.o. 7713649</p>



## FIAT UNO - FIORINO



**1514**  
kit fuelle transmisión l/rueda  
r.o. 5987092



**1577**  
kit fuelle transm. l/rueda Turbo i.e. hasta '88  
r.o. 7578083



**3607**  
tapón radiador 0,7 bar  
r.o.



**057**  
soporte tubo de escape Diesel  
r.o. 5987998



**165**  
soporte tubo de escape  
r.o. 4387294



**207**  
soporte tubo de escape  
r.o. 4287293

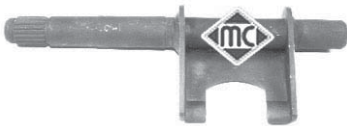

**4268**  
horquilla embrague  
r.o. 7617578



**094**  
soporte tubo de escape Diesel  
r.o. 7612390



**2720**  
soporte escape FIORINO  
r.o. 7527810



**2789**  
tapón bloque motor FIRE Ø 50 mm  
r.o. 7579570

**¡Nuevo!**



**4893**  
tapón bloque motor FIRE Ø 51 mm  
r.o. 91600682

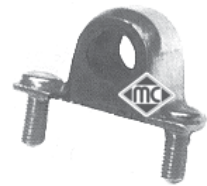

**2648**  
soporte central barra estabilizadora  
r.o. 7603476



**90002**  
bujes rueda delantera hasta '89  
r.o. 4390949



**90001**  
bujes rueda delantera desde '89 salvo Diesel y CS, r.o. 4399777

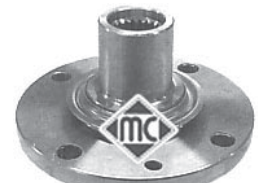

**90017**  
bujes rueda delantera desde '89 Diesel y CS  
r.o. 7643294

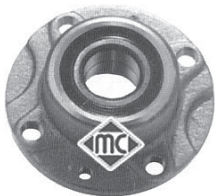

**90501**  
bujes rueda trasera hasta '89  
r.o. 4381043



**90510**  
bujes rueda trasera desde '89  
r.o. 7603485

**¡Nuevo!**



**3756**  
termostato completo UNO Fire 1.0  
r.o. 7589135

**¡Nuevo!**



**3757**  
termostato completo UNO 1.7D '89 a '95  
r.o. 7625346



**96017**  
latiguillo freno delantero (436 mm)  
r.o. 5966685



**96020**  
latiguillo freno trasero (218 mm)  
r.o. 5944402

## CANALIZACIONES DE AGUA:

**ESCORT - ORION 1300 - 1600 cc gasolina  
(motores HL) desde 1981 hasta 1986**

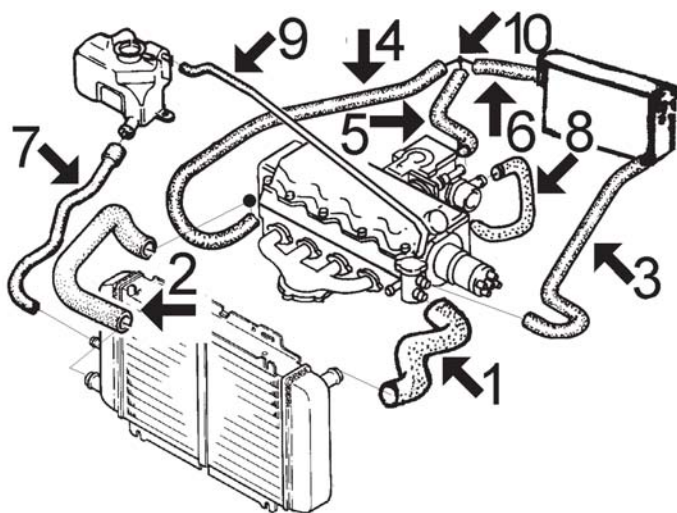

- 1- 8024 mgtto superior radiador
- 2- n/d mgtto inferior radiador
- 3- 7881 mgtto de calefactor a termostato
- 4- 7882 mgtto de calefactor a bomba de agua
- 5- 8204 mgtto de racor empalme a carburador (versiones con stárter automático)
- 8027 mgtto de racor empalme a colector (versiones con stárter manual)
- 6- 8033 mgtto de racor empalme a calefactor
- 7- 119 mgtto de botella a radiador: Cortar de rollo MC-119 Ø 16x22 mm, longitud 550 mm
- 8- 8203 mgtto de carburador a colector de admisión, sólo versiones con stárter automático
- 9- 7946 mgtto de sobrante de botella a termostato
- 10- 2717 racor enlace mgttos de calefacción

**ESCORT - ORION 1400 - 1600 cc gasolina  
(motores HL) desde 1986 hasta 1991:**

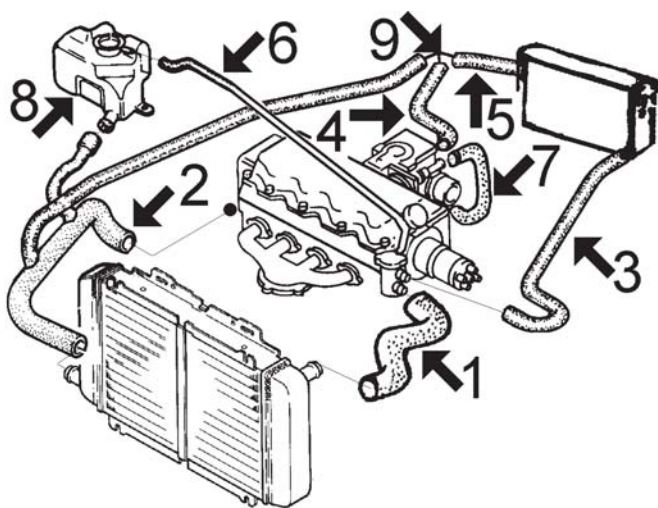

- 1- 8024 mgtto superior radiador
  - 2- 8025 mgtto inferior radiador (4 vias)
  - 3- 8026 mgtto de calefactor a termostato 1400
  - 7881 mgtto de calefactor a termostato 1600
  - 4- 8027 mgtto de racor empalme a colector (versiones con stárter manual)
  - 8204 mgtto de racor empalme a carburador (versiones con stárter automático)
  - 5- 8033 mgtto de racor empalme a calefactor
  - 6- 7301 mgtto de sobrante de botella a termostato
  - 7- 8203 mgtto de carburador a colector de admisión, sólo versiones con stárter automático
  - 8- 3561 tapón botella de expansión
  - 3512 botella de expansión
  - 9- 2717 racor enlace mgttos calefacción
- 8360 juego mgttos desvaporizadores

## FORD ESCORT - ORION

### ESCORT - ORION 1600 Diesel (1984 - 1988):

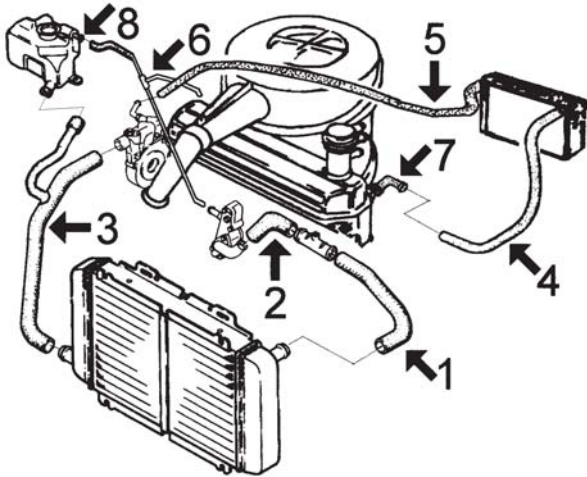

- 1- n/d mgto superior radiador (1er. tramo)
- 2- n/d mgto superior radiador (2º tramo)
- 3- n/d mgto inferior radiador hasta '86
- n/d mgto inferior radiador desde '86 (3 vias)
- 4- 8031 mgto de calefactor a boquilla en culata
- 5- 8035 mgto de calefactor a bomba de agua
- 6- n/d mgto de sobrante de botella a termostato y a culata (3 vias)
- 7- 3061 boquilla roscada en culata (codo de aluminio)
- 8- 3561 tapón botella expansión
- 3512 botella de expansión desde '86
  
- 8361 juego mgtos desvaporizadores

### ESCORT - ORION 1300 - 1400 - 1600 cc gasolina desde 1991 hasta 1998:

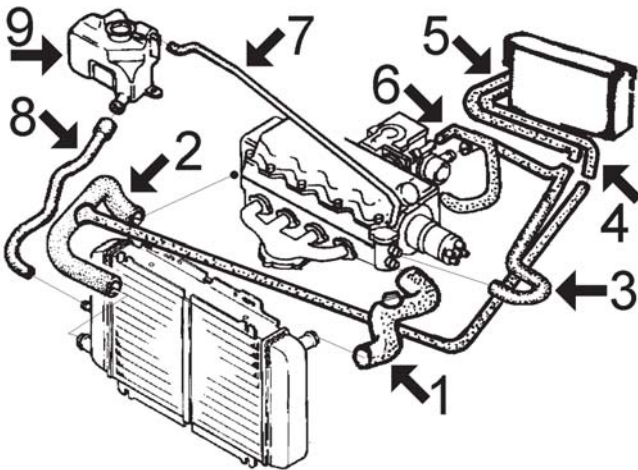

- 1- 8024 mgto superior radiador sin aire acondicionado
- 8139 mgto superior radiador con aire acondicionado (con boquilla roscada para sensor)
- 2- 8125 mgto inferior radiador (3 vias)
- 3- 8346 mgto de calefactor a calefactor (1er. tramo) y a carburador (3 vias) 1.6i
- 9144 mgto de calefactor a calefactor (1er. tramo) y a carburador (3 vias) 1.4i-1.6 carburador
- 4- 8347 mgto de 3º via de mgto inferior a calefactor
- 5- 8347 mgto de calefactor a enlace mgto a termostato
- 6- 8204 mgto de carburador a colector de admisión
- 7- 8353 mgto de sobrante de botella a termostato
- 8- 8367 mgto de botella a radiador
- 9- 3561 tapón botella de expansión
- 3579 botella de expansión
  
- 8360 juego mgtos desvaporizadores

### ESCORT - ORION 1800 Diesel (no TurboD) desde 1988:

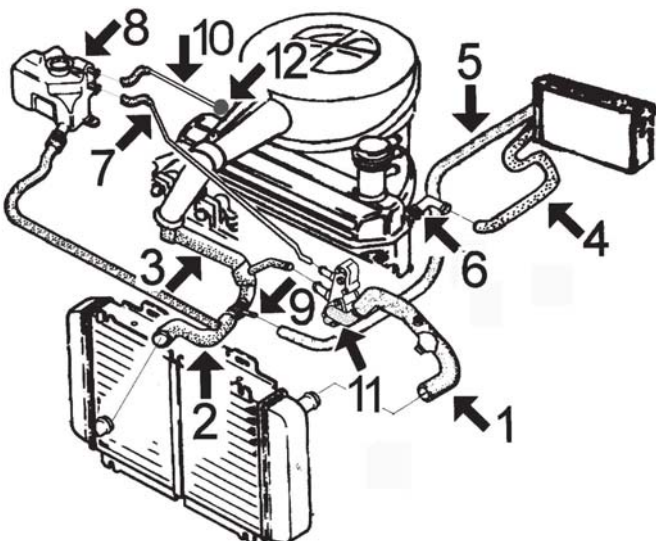

- 1- 8350 mgto superior radiador sin aire acondicionado
- 8131 mgto superior radiador con aire acondicionado (con boquilla roscada para sensor)
- 2- 8355 mgto inferior radiador desde '88 hasta '91
- 8356 mgto inferior radiador desde '91
- 3- 8138 mgto de bomba de agua a racor empalme mgto inferior y a termostato (3 vias)
- 4- 8349 mgto de calefactor a boquilla roscada en culata
- 5- 8348 mgto de calefactor a racor empalme entre mgto inferior y mgto de bomba de agua
- 6- 3061 boquilla metálica roscada en culata (codo, aluminio)
- 3126 boquilla metálica roscada en culata (recta, aluminio)
- 7- 116 mgto de sobrante de botella a termostato. Cortar de rollo MC-116 Ø 8x14 longitud 70 cms.
- 8- 3561 tapón botella de expansión
- 3512 botella de expansión hasta '91
- 3579 botella de expansión desde '91
- 9- 3066 tubo metálico enlace mgto inferior
- 10- 8351 mgto de sobrante de botella a racor en culata, sólo desde modelo '91
- 11- 4845 cuerpo de termostato con junta
- 3606 tapa de termostato hasta '96 (plástico)
- 3151 tapa de termostato desde '96 (aluminio)
- 12- 3152 boquilla en culata (recta, Ø 8 mm)
- 3149 boquilla en culata (codo, Ø 8 mm)
  
- 8361 juego mgtos desvaporizadores



## FORD ESCORT - ORION

### ESCORT - ORION 1.6 - 1.8 gasolina, motores ZETEC de 16v. desde 1993

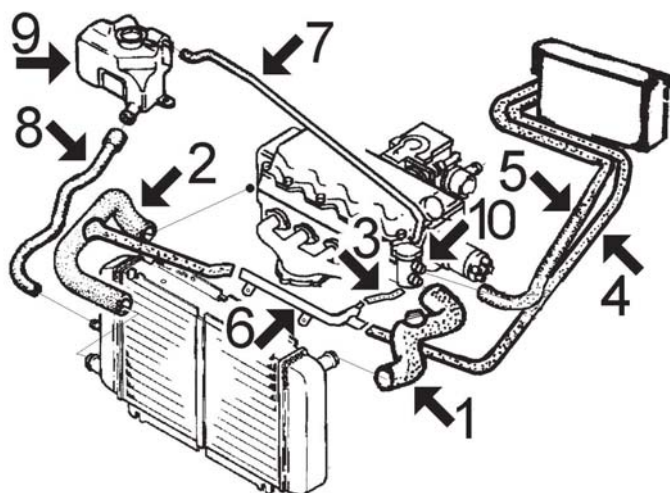

- 1- 8140 mgtto superior radiador
- 2- 8357 mgtto inferior radiador hasta '97  
8820 mgtto inferior radiador desde '97
- 3- 8358 mgtto de tubo metálico a caja termostato
- 4- 8348 mgtto de calefactor a tubo metálico
- 5- 8349 mgtto de calefactor a caja termostato
- 6- 3089 tubo de agua metálico
- 7- 8353 mgtto de sobrante de botella a caja termostato
- 8- 8368 mgtto de botella a radiador
- 9- 3561 tapón botella de expansión  
3579 botella de expansión
- 10- 3562 tapa de termostato

### ESCORT - ORION 1.8 TURBODIESEL desde 1993:

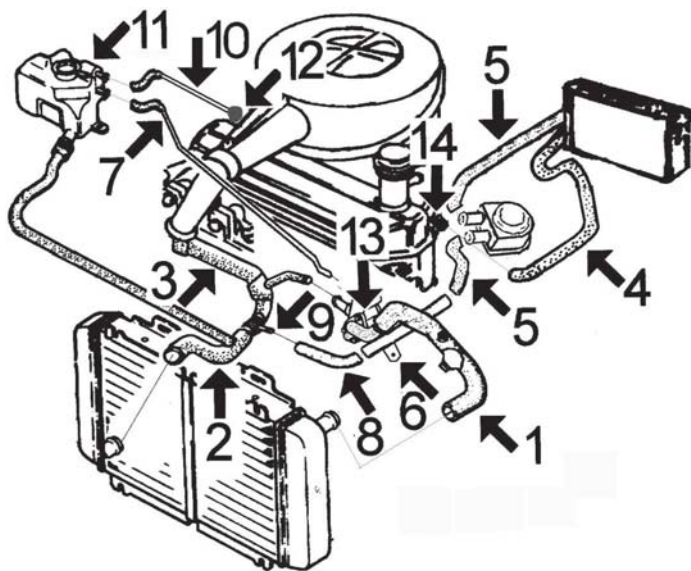



- 1- 8963 mgtto superior radiador sin aire acondicionado  
8369 mgtto superior radiador con aire acondicionado
- 2- 8356 mgtto inferior radiador
- 3- 8138 mgtto de bomba de agua a racor metálico y a caja de termostato (3 vías)
- 4- 8347 mgtto de calefactor a racor en culata
- 5- 8366 juego mgttos del intercambiador: mgtto de calefactor a bloque y mgtto de tubo metálico a bloque
- 6- n/d tubo de agua metálico
- 7- 116 mgtto de sobrante de botella a caja de termostato, cortar de rollo MC-116 Ø 8x14 longitud 70 cms.
- 8- 8033 mgtto de tubo metálico a pipeta en tubo metálico
- 9- 3066 tubo metálico enlace mgtto inferior con mgtto de bomba de agua
- 10- 8352 mgtto de sobrante de botella a caja de termostato y a culata, 3 vías
- 11- 3561 tapón botella de expansión  
3579 botella de expansión
- 12- 3152 boquilla en culata (recta, Ø 8 mm)  
3149 boquilla en culata (codo, Ø 8 mm)
- 13- 4845 cuerpo de termostato  
3606 tapa de termostato hasta '96 (plástico)  
3151 tapa de termostato desde '96 (aluminio)
- 14- 3061 boquilla metálica roscada en culata (codo, aluminio)  
3126 boquilla metálica roscada en culata (recta, aluminio)

8361 juego mgttos desvaporizadores



## FORD ESCORT - ORION

 <p><b>7301</b> mgto de sobrante de botella 1.4-1.6 desde '86, r.o.</p>	 <p><b>7946</b> mgto de sobrante de botella 1.4-1.6 d/ '90 y 1.3-1.6 hasta '86, r.o.</p>	 <p><b>7881</b> mgto de calefactor 1.3-1.6 r.o. 1604864</p>
 <p><b>7882</b> mgto de calefactor a bomba 1.3-1.6 h/ '86 r.o. 6117937</p>	 <p><b>8024</b> mgto superior radiador 1.4-1.6 r.o. 1643126</p>	 <p><b>8025</b> mgto inferior radiador 1.4-1.6 desde '86 r.o. 6159897-6165328</p>
 <p><b>8026</b> mgto calefactor a termostato 1.4 r.o. 6165793</p>	 <p><b>8027</b> mgto de calefactor a colector 1.4-1.6 r.o. 6153992</p>	 <p><b>8031</b> mgto izquierdo calefactor 1.6 Diesel r.o. 6163327-6147485</p>
 <p><b>8033</b> mgto de racor a calefactor 1.3-1.4-1.6 r.o. 6091771</p>	 <p><b>8035</b> mgto derecho calefactor 1.6 Diesel r.o. 6141351</p>	 <p><b>8125</b> mgto inferior radiador 1.4-1.6 desde '90 r.o. 6632151</p>
 <p><b>8131</b> mgto superior radiador 1.8 Diesel con aire acondicionado, r.o. 6609334-6965910</p>	 <p><b>8138</b> mgto de bomba de agua 1.8 Diesel r.o. 6466032-6180942</p>	 <p><b>8139</b> mgto superior radiador 1.4-1.6 desde '90 con aire acondicionado, r.o. 6557103</p>
 <p><b>8140</b> mgto superior radiador Escort '92 EFI (con boquilla roscada), r.o. 6827019</p>	 <p><b>8203</b> mgto de carburador a colector 1.3-1.4-1.6 (con stárter automático), r.o. 6170465</p>	 <p><b>8204</b> mgto de racor a carburador 1.3-1.4-1.6 con stárter automático, r.o. 6179685</p>
 <p><b>8346</b> mgto de calefactor a carburador y colector 1.4-1.6 modelo '91, r.o. 6562154-6617104</p>	 <p><b>8347</b> mgto de calefactor 1.4-1.6 modelo '91 r.o. 7072771</p>	 <p><b>8348</b> mgto de calefactor 1.8 Diesel r.o. 1654411</p>

## FORD ESCORT - ORION



**8349**  
mgto de calefactor 1.8 Diesel  
r.o. 1654409



**8350**  
mgto superior radiador 1.8D sin aire acond.  
r.o. 1661877



**8352**  
mgto de sobrante de botella 1.8D/TD d/'95  
r.o. 1026908



**8353**  
mgto de sobrante de botella 1.6-1.8 Zetec  
r.o. 7168233-7168231



**8355**  
mgto inferior radiador 1.8 D hasta '91  
r.o. 6201895



**8356**  
mgto inferior radiador 1.8 D y TD desde '91  
r.o. 1055271-6755964



**8357**  
mgto inferior radiador motores Zetec 16v  
hasta '97, r.o. 7112681-6828716



**8358**  
mgto de tubo metálico a termostato Zetec  
r.o. 1052034



**8360**  
jgo mgto desvaporizadores 1.4-1.6 d/'86  
r.o. 6196128/6196127+6140438/6137838



**8361**  
jgo mgto desvaporizadores 1.8 D y TD  
r.o. 6179491+6162286



**8366**  
juego mgto intercambiador 1.8 TurboD  
r.o. 6596757+7112336



**8367**  
mgto de botella a radiador 1.4-1.6 d/'91  
r.o. 6710520



**8368**  
mgto de botella a radiador motor Zetec 16v  
r.o. 6939318



**8369**  
mgto superior radiador 1.8 TurboD aire ac.  
r.o. 7293450



**8820**  
mgto inferior radiador motores Zetec  
desde '97, r.o.



**8963**  
mgto sup radiador 1.8 TurboD sin aire acond.  
r.o.



**9144**  
mgto calefactor 1.4i-1.6 desde '91  
r.o. 6617104



**3061**  
boquilla en culata 1.6 D y 1.8 Diesel y en  
colector 1.3-1.4-1.6, r.o. 1592026



**3066**  
tubo enlace mgto inferior 1.8 Diesel y TD  
r.o. 6180946

## FORD ESCORT - ORION

 <p><b>3089</b> tubo de agua metálico 1.6-16v motor Zetec r.o. 1057173</p>	 <p><b>3152</b> racor en culata 1.8 Diesel y TD (Ø 8 mm) (alternativamente a MC-3149), r.o.</p>	 <p><b>3149</b> boquilla en culata 1.8 Diesel y TD (Ø 8mm) (alternativamente a MC-3152), r.o.</p>
 <p><b>3126</b> <span style="float: right;">aluminio</span> boquilla en culata 1.8 D-TD (Ø 16mm) (alternativamente a MC-3061), r.o.</p>	 <p><b>3606</b> tapa de termostato 1.8 Diesel-TD hasta '96 r.o. 6189058</p>	 <p><b>3151</b> tapa de termostato 1.8 Diesel-TD desde '96 r.o. 1031904</p>
 <p><b>3562</b> tapa de termostato 1.6-16v Zetec r.o. 6574963</p>	 <p><b>3512</b> botella de expansión desde '86 hasta '91 r.o. 6134285-6134284</p>	 <p><b>3579</b> botella de expansión desde '91 r.o. 1047497-6589367</p>
 <p><b>3561</b> tapón botella de expansión r.o. 7267962</p>	 <p><b>2717</b> racor empalme mgntos de calefacción r.o. 6085829</p>	 <p><b>7334</b> tubo llenado combustible (Ø 44 x 53-largo 330) r.o. 6117885</p>
 <p><b>4845</b> cuerpo de termostato con junta 1.8D-TD r.o. 1079905-1131995</p>	 <p><b>2728</b> <span style="float: right;">Ø 12 mm</span> tapón obturador salida adicional radiador r.o. 1610100</p>	

## SUSPENSION DELANTERA Y SOPORTES DE MOTOR

ESCORT 1.1 desde 1981 hasta 1983:

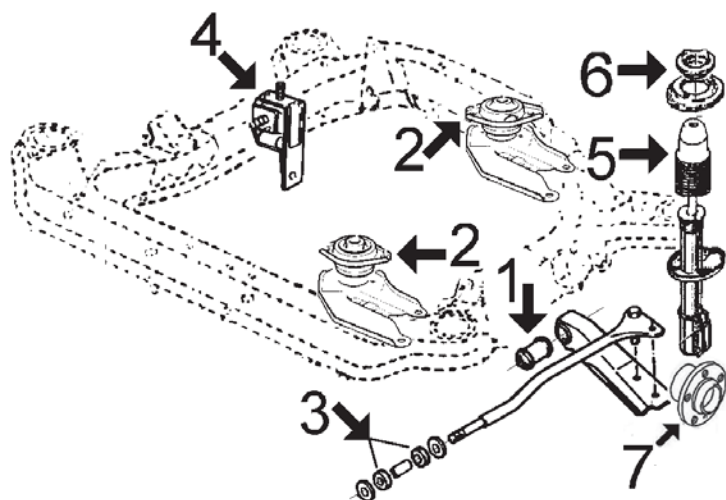

- 1- 429 silentbloc brazo delantero
- 2- 544 soporte de motor delantero y trasero 1.1
- 3- 775 jgo silentblocs tirante brazo delantero
- 4- 2484 soporte de motor derecho 1.1
- 5- 475 capuchón amortiguador delantero
- 6- 2729 soporte amortiguador delantero
- 7- 90021 buje rueda delantera

ESCORT y ORION 1.3 (HL) y 1.6 Gasolina desde 1981 hasta 1986:  
 ESCORT 1.6 Diesel y ORION 1.6 Diesel desde 1984 hasta 1986:

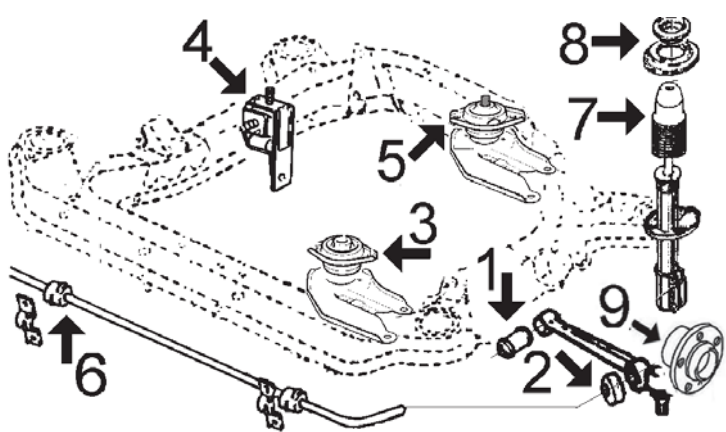

- 1- 881 silentbloc extremo brazo delantero
- 2- 734 silentbloc central brazo delantero
- 3- 544 soporte de motor delantero Escort gasolina (No Orion)
- 2712 soporte de motor delt. Orion gasolina y diésel y Escort sólo diésel (hidráulico negro)
- 4- n/d soporte de motor dcho. Escort y Orion gasolina
- 2368 soporte de motor dcho. Escort y Orion diésel
- 5- 544 soporte de motor trasero Escort gasolina (No Orion)
- 954 soporte de motor tras. Orion gasolina y diésel y Escort sólo diésel (hidráulico verde)
- 6- n/d goma barra estabilizadora Ø 22 mm
- n/d goma barra estabilizadora Ø 24 mm
- 7- 475 capuchón amortiguador delantero
- 8- 2729 soporte amortiguador delantero
- 9- 90021 buje rueda delantera



## FORD ESCORT - ORION

**ORION (no ESCORT) 1.4 - 1.6 Gasolina desde 1986 hasta 1991:  
ORION y ESCORT 1.6 Diesel desde 1986 hasta 1988:**

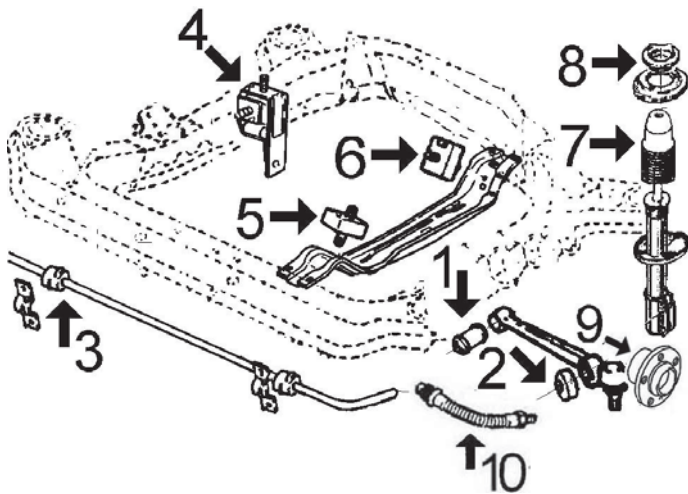

- 1- 881 silentbloc extremo brazo delantero
- 2- 734 silentbloc central brazo delantero
- 3- 2712 soporte de motor delantero (hidráulico negro)
- 4- 2716 soporte de motor derecho Gasolina  
2368 soporte de motor derecho Diésel
- 5- 954 soporte de motor trasero (hidráulico verde)
- 6- 2912 goma barra estabilizadora Ø 22 mm desde '87  
2913 goma barra estabilizadora Ø 24 mm desde '87
- 7- 475 capuchón amortiguador delantero
- 8- 2729 soporte amortiguador delantero
- 9- 90021 buje rueda delantera
- 10- 96039 latiguillo freno delantero (375 mm)

**ESCORT (no ORION) 1.3 - 1.4 y 1.6 Gasolina desde 1986 hasta 1991:  
ESCORT y ORION 1.8 Diesel desde 1988 hasta 1991:**

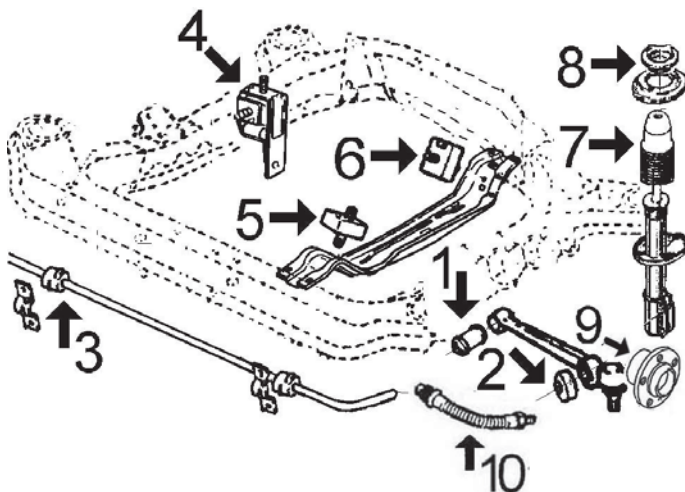

- 1- 881 silentbloc extremo brazo delantero
- 2- 734 silentbloc central brazo delantero
- 3- 2912 goma barra estabilizadora Ø 22 mm desde '87  
2913 goma barra estabilizadora Ø 24 mm desde '87
- 4- 929 soporte de motor derecho Escort 1.4-1.6 gasolina desde '86 hasta '89  
2484 soporte de motor derecho 1.3 desde '86 hasta '91  
2716 soporte de motor derecho Escort 1.4-1.6 gasolina desde '89 hasta '91  
2625 soporte de motor derecho 1.8 Diesel hasta '91
- 5- 512 soporte de motor delantero gasolina y diésel
- 6- 512 soporte de motor trasero 1.3-1.4 y 1.6 gasolina  
833 soporte de motor trasero 1.8 Diesel hasta '91
- 7- 475 capuchón amortiguador delantero
- 8- 2729 soporte amortiguador delantero
- 9- 90021 buje rueda delantera
- 10- 96039 latiguillo freno delantero

**ESCORT y ORION 1.3 BL - 1.4 HL - 1.6 HL gasolina desde 1991:  
(excepto motores ZETEC-16v)**

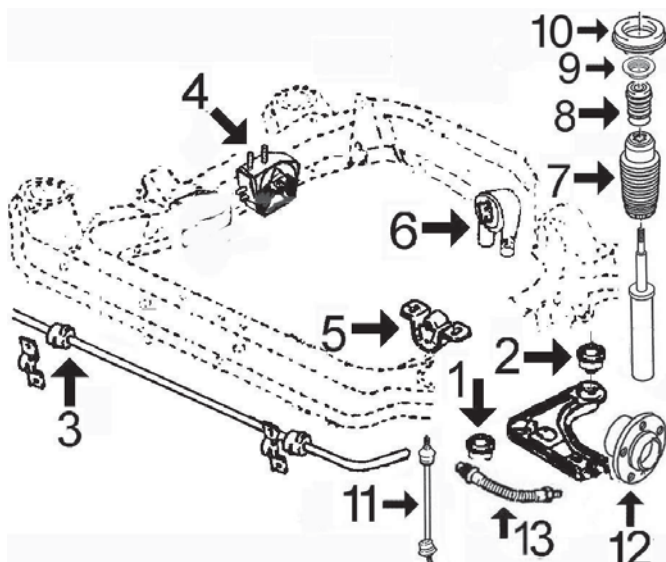

- 1- 980 silentbloc anterior trapecio delantero
- 2- 981 silentbloc posterior trapecio delantero
- 3- 2632 goma barra estabilizadora hasta '94 (Ø 16 mm)  
2631 goma barra estabilizadora desde '94 (Ø 16 mm)
- 4- 936 soporte motor derecho
- 5- 2369 soporte motor izquierdo
- 6- 2486 soporte motor trasero hasta '96  
2992 soporte motor trasero desde '96
- 7- 2998 capuchón amortiguador
- 8- 2996 tope goma suspensión delantera
- 9- 4212 rodamiento soporte amortiguador hasta '95  
4210 rodamiento soporte amortiguador desde '95
- 10- 2650 soporte amortiguador delantero hasta '95  
4012 soporte amortiguador delantero desde '95
- 11- 4263 bieleta puntal barra estabilizadora
- 12- 90041 buje rueda delantera
- 13- 96081 latiguillo freno delantero izquierdo (470 mm)  
96052 latiguillo freno delantero izquierdo (450 mm)  
96080 latiguillo freno delantero derecho (470 mm)  
96048 latiguillo freno delantero derecho (450 mm)

## FORD ESCORT - ORION

ESCORT - ORION gasolina

motor 1.6 ZETEC-16v desde 1992  
motor 2.0 RS-2000 desde 1992

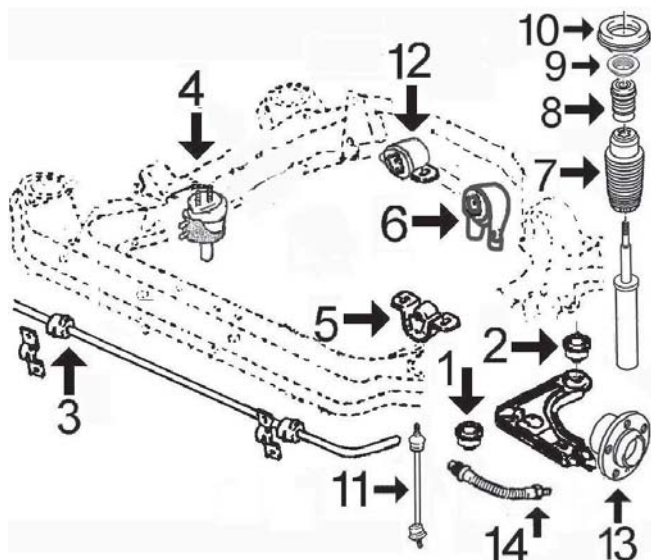

- 1- 980 silentbloc anterior trapecio delantero
- 2- 981 silentbloc posterior trapecio delantero
- 3- 2632 goma barra estabilizadora hasta '94 (Ø 16 mm)
- 2631 goma barra estabilizadora desde '94 (Ø 16 mm)
- 4- n/d soporte motor derecho 1.6 Zetec
- 4315 soporte motor derecho 2.0 RS
- 5- 2369 soporte motor delantero izquierdo hasta 2/'94
- 2993 soporte motor delantero izquierdo desde 2/'94
- 6- 2486 soporte motor trasero izquierdo hasta 8/'92
- 2992 soporte motor trasero izquierdo desde 8/'92
- 7- 2998 capuchón amortiguador
- 8- 2996 tope goma suspensión delantera
- 9- 4212 rodamiento soporte amortiguador hasta '95
- 4210 rodamiento soporte amortiguador desde '95
- 10- 2650 soporte amortiguador delantero hasta '95
- 4012 soporte amortiguador delantero desde '95
- 11- 4263 bieleta puntal barra estabilizadora
- 12- 2995 soporte motor inferior trasero
- 13- 90041 buje rueda delantera
- 14- 96081 latiguillo freno delantero izquierdo (470 mm)
- 96052 latiguillo freno delantero izquierdo (450 mm)
- 96080 latiguillo freno delantero derecho (470 mm)
- 96048 latiguillo freno delantero derecho (450 mm)

ESCORT - ORION 1.8 DIESEL (no TurboD) desde '91:

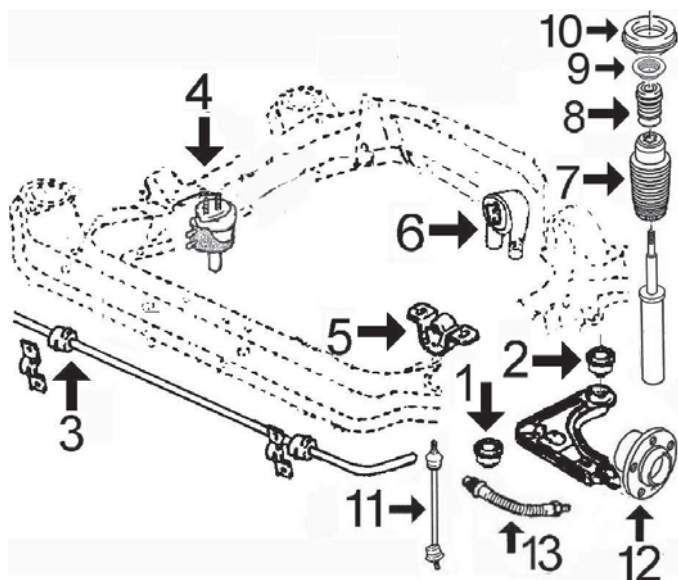

- 1- 980 silentbloc anterior trapecio delantero
- 2- 981 silentbloc posterior trapecio delantero
- 3- 2632 goma barra estabilizadora hasta '94 (Ø 16 mm)
- 2631 goma barra estabilizadora desde '94 (Ø 16 mm)
- 4- 4315 soporte motor derecho
- 5- 2369 soporte motor izquierdo hasta 6/'93
- 2994 soporte motor izquierdo desde 6/'93
- 6- 2486 soporte motor trasero hasta 6/'93
- 2992 soporte motor trasero desde 6/'93
- 7- 2998 capuchón amortiguador
- 8- 2996 tope goma suspensión delantera
- 9- 4212 rodamiento soporte amortiguador hasta '95
- 4210 rodamiento soporte amortiguador desde '95
- 10- 2650 soporte amortiguador delantero hasta '95
- 4012 soporte amortiguador delantero desde '95
- 11- 4263 bieleta puntal barra estabilizadora
- 12- 90041 buje rueda delantera
- 13- 96081 latiguillo freno delantero izquierdo (470 mm)
- 96052 latiguillo freno delantero izquierdo (450 mm)
- 96080 latiguillo freno delantero derecho (470 mm)
- 96048 latiguillo freno delantero derecho (450 mm)

## FORD ESCORT - ORION

### ESCORT - ORION 1.8 TURBODIESEL desde '91:

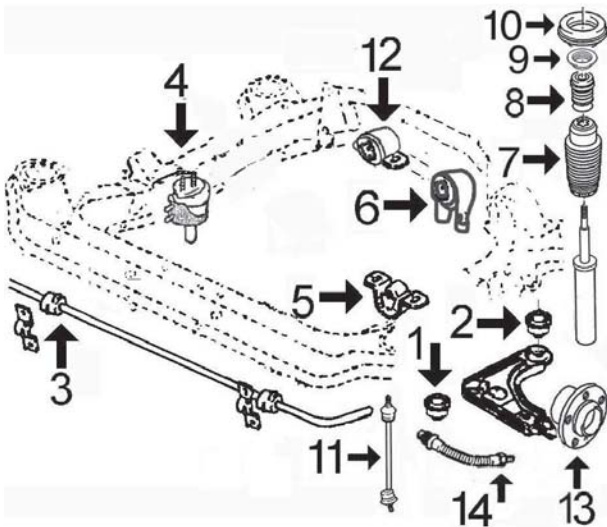

- 1- 980 silentbloc anterior trapecio delantero
- 2- 981 silentbloc posterior trapecio delantero
- 3- 2632 goma barra estabilizadora hasta '94 (Ø 16 mm)
- 2631 goma barra estabilizadora desde '94 (Ø 16 mm)
- 4- 4315 soporte motor derecho
- 5- 2994 soporte motor delantero izquierdo
- 6- 2992 soporte motor trasero izquierdo
- 7- 2998 capuchón amortiguador
- 8- 2996 tope goma suspensión delantera
- 9- 4212 rodamiento soporte amortiguador hasta '95
- 4210 rodamiento soporte amortiguador desde '95
- 10- 2650 soporte amortiguador delantero hasta '95
- 4012 soporte amortiguador delantero desde '95
- 11- 4263 bieleta puntal barra estabilizadora
- 12- 2995 soporte motor inferior trasero
- 13- 90041 buje rueda delantera
- 14- 96081 latiguillo freno delantero izquierdo (470 mm)
- 96052 latiguillo freno delantero izquierdo (450 mm)
- 96080 latiguillo freno delantero derecho (470 mm)
- 96048 latiguillo freno delantero derecho (450 mm)

### SUSPENSION TRASERA ESCORT y ORION hasta modelo '91:

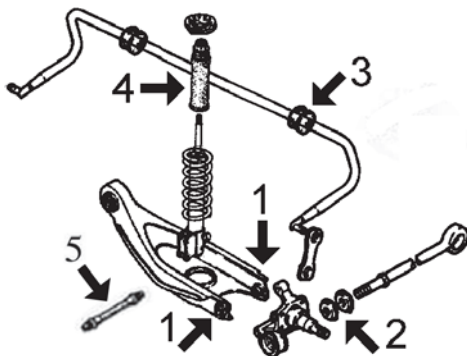

- 1- 2808 silentbloc trapecio trasero (2 por brazo)
- 2- 734 silentbloc tirante de reacción (2 por tirante)
- 3- 2634 goma barra estabilizadora Ø 12 mm
- 2635 goma barra estabilizadora Ø 20 mm
- 4- 475 capuchón amortiguador trasero
- 5- 96037 latiguillo freno trasero izquierdo (250 mm)
- 96038 latiguillo freno trasero derecho (225 mm)

### SUSPENSION TRASERA ESCORT y ORION desde modelo '91:

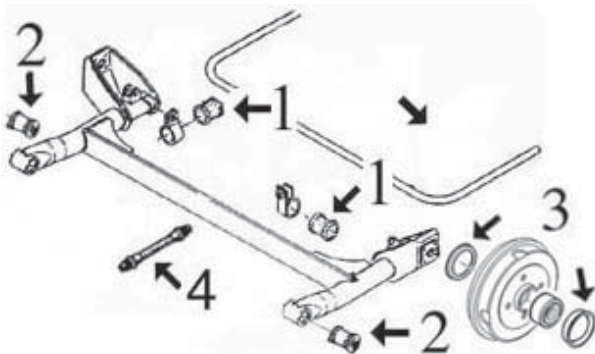

- 1- 2632 goma barra estabilizadora Ø 16 mm
- 2634 goma barra estabilizadora Ø 12 mm
- 2- 2690 silentbloc puente trasero hasta '95
- 2997 silentbloc puente trasero desde '95
- 3- 4849 juego retén eje-mangueta y tapa cubo rueda
- 4- 96141 latiguillo freno trasero (495 mm)



## FORD ESCORT - ORION



**429**  
silentbloc extremo brazo delantero 1.1  
r.o. 1619120

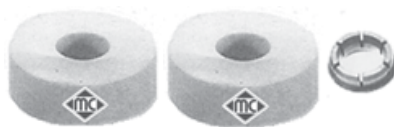

**775**  
jgo silentbloc (poliuretano) tirante brazo 1.1  
r.o. 6140086+6154160



**881**  
silentbloc extremo brazo delantero 1.3-1.4  
1.6-1.6Dy 1.8D, r.o. 6087890



**734**  
silentbloc central brazo delantero 1.3-1.4-1.6y Diesel, r.o. 1652910



**980**  
silentbloc anterior trapecio delantero desde modelo '91, r.o. (no hay despiece)



**981**  
silentbloc posterior trapecio delantero desde modelo '91, r.o. (no hay despiece)

con ánima metálica



**2912** Ø 22 mm  
goma barra estabilizadora desde '87 a '91  
r.o. 1634900

con ánima metálica

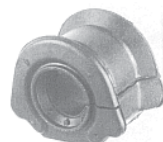

**2913** Ø 24 mm  
goma barra estabilizadora desde '87 a '91  
r.o. 1634901



**2631** Ø 16 mm  
goma barra estabiliz. delantera desde '91 a '94  
r.o. 6543416



**2632** Ø 16 mm  
goma barra estabiliz. delantera desde '94  
r.o. 7102392



**2996**  
tope de goma suspensión delantera desde '91, r.o. 6532212



**4212**  
rodamiento soporte amortiguador delantero desde '91 a '95, r.o.



**4210**  
rodamiento soporte amortiguador delantero desde '95, r.o. 7331751-1002513



**475**  
capuchón amortiguador hasta '91  
r.o. 6136219



**2998**  
capuchón amortiguador delantero desde '95  
r.o. 7379687



**4263**  
bieleta puntal barra estabilizadora desde '91  
r.o. 1661237



**2729**  
soporte amortiguador delantero desde '81 hasta '91, r.o. 6150277



**2650**  
soporte amortiguador delantero desde '91 hasta '95, r.o. 6495311

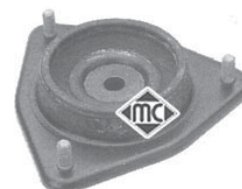

**4012**  
soporte amortiguador delantero desde '95  
r.o. 7350847



## FORD ESCORT - ORION



**544**  
soporte motor delantero y trasero 1.3-1.6 hasta '86, r.o. 6140218 - 6140223

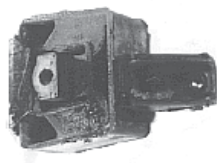

**2484**  
soporte motor derecho 1.3 desde '86 a '91 r.o. 1638511 - 6160228



**2716**  
soporte de motor derecho 1.4-1.6 desde '89 hasta '91, r.o. 6178900



**929**  
soporte de motor derecho 1.4-1.6 desde '86 hasta '89, r.o. 1637005 - 1640021



**2368**  
soporte de motor derecho 1.6 Diesel r.o. 6139310 - 6132061 - 6160229



**2625**  
soporte de motor derecho 1.8 Diesel r.o. 6186726



**954** "verde"  
soporte de motor trasero Orion todos hasta '91 y Escort 1.6 Diesel, r.o. 6172938



**2712** "negro"  
soporte de motor delantero Orion todos hasta '91 y Escort 1.6 Diesel, r.o. 6137369

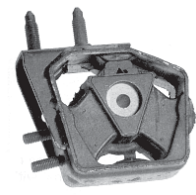

**936**  
soporte de motor derecho 1.4-1.6 d/'91 hasta '93, r.o. 6793344

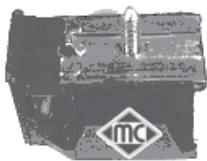

**512** tetones simétricos  
soporte de motor delantero y trasero 1.4-1.6 desde '86 hasta '91, r.o. 6203710

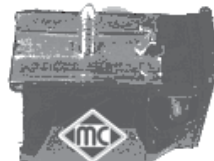

**833** tetones asimétricos  
soporte de motor trasero 1.8 Diesel h/'91 r.o. 6170427 - 1661786

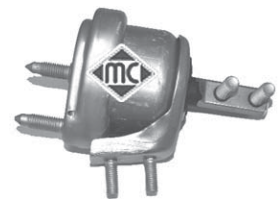

**4315**  
soporte motor derecho 1.6 Zetec, D- TD r.o. 7204687



**2486**  
soporte de motor trasero todos desde '91 r.o. 6766044 - 6766045



**2369**  
soporte de motor izquierdo todos desde '91 r.o. 6494751 - 6845224 - 7023194



**2992** hidráulico  
soporte motor trasero izquierdo desde '92 r.o. 1040404



**2993**  
soporte motor izquierdo gasolina desde '94 r.o. 7023194



**2994**  
soporte motor izquierdo 1.8 TurboDiesel r.o. 1025086



**2995**  
soporte motor inferior 1.8 TurboDiesel r.o. 6656135



**2634**  
goma barra estabiliz. trasera Ø 12 mm r.o. 1652936 - 6046476



**2632**  
goma barra estabiliz. trasera Ø 16 mm r.o. 7102392



**2635**  
goma barra estabilizadora trasera Ø 20 mm r.o. 1659591

## FORD ESCORT - ORION



**2808**  
silentbloc trapecio trasero hasta '91  
r.o. no hay despiece



**2690**  
silentbloc brazo trasero desde '91 hasta '95  
r.o. 6745350



**2997**  
silentbloc brazo trasero desde '95  
r.o. 1041979



**4849**  
juego retén y tapa cubo de rueda trasera  
r.o. 1003554+1103509



**90021**  
buje rueda delantera hasta '91  
r.o. 1644842

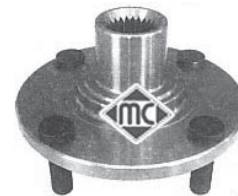

**90041**  
buje rueda delantera desde '91  
r.o. 6517013



**96039**  
latiguillo freno delantero '86 a '91 (417 mm)  
r.o. 6135220



**96081**  
latiguillo freno delantero **izquierdo** desde '91  
(470 mm), r.o. 6941702



**96080**  
latiguillo freno delantero **derecho** desde '91  
(470 mm), r.o. 6941704



**96052**  
latiguillo freno delantero **izquierdo** desde '91  
(450 mm), r.o. 7111981



**96048**  
latiguillo freno delantero **derecho** desde '91  
(450 mm), r.o. 7111983



**96037**  
latiguillo freno trasero **izquierdo** '86 a '91  
(250 mm), r.o. 4167824



**96038**  
latiguillo freno trasero **derecho** '86 a '91  
(225 mm), r.o.



**96141**  
latiguillo freno trasero desde '91 (495 mm)  
r.o. 7272225

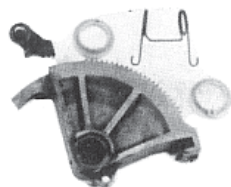

**325**  
serreta pedal embrague hasta '89  
r.o. 6186200

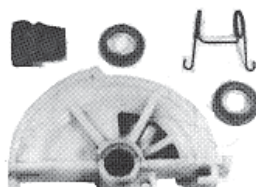

**519**  
serreta pedal embrague desde '89 hasta '95  
r.o. 6180329-6189055



**2819**  
serreta pedal embrague desde '95  
r.o. 1029013(7333649-7333650)



**4370**  
palanca de desembrague 1.8 Diesel  
r.o. 6737887

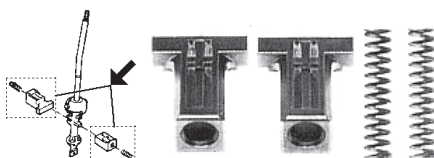

**2303**  
juego casquillos palanca cambio (5 veloci-  
dades desde '87), r.o. 6172154

# FORD ESCORT - ORION

 <p><b>1534</b> fuelle cremallera manual desde '83 r.o. 6127744</p>	 <p><b>1527</b> fuelle cremallera asistida r.o. 6182818</p>	 <p><b>442</b> casquillo cremallera manual hasta '83 r.o. 6076533</p>
 <p><b>2384</b> casquillo cremallera manual desde '83 r.o.</p>	 <p><b>1623</b> kit rep. transmisión l/rda 1.1 r.o. 6028724</p>	 <p><b>1623E</b> para montar con cono kit rep. transmisión l/rueda 1.1 r.o. 6028724</p>
 <p><b>1342E</b> para montar con cono kit rep. transmisión l/rueda 1.3-1.4-1.6-D r.o. 6043191</p>	 <p><b>1342</b> kit rep. transmisión l/rueda 1.3-1.4-1.6-D r.o. 6043191</p>	 <p><b>1341</b> kit rep. transmisión l/cambio 1.1 y Diesel r.o. 6028751</p>
 <p><b>2451</b> kit rep. transmisión l/rueda 1.8 D desde '91 y Zetec, r.o. 6676136</p>	 <p><b>1227</b> kit rep. transmisión l/cambio D-TD d/'92 r.o. 6676140</p>	 <p><b>3705</b> tapón llenado aceite motor Zetec 1.4-1.6 y 1.8D, r.o. 7167665</p>
 <p><b>4820</b> polea cigüeñal 1.8 Diesel r.o. 6186296</p>	 <p><b>4815</b> polea cigüeñal 1.8 Diesel r.o. 6811202</p>	
 <p><b>247</b> soporte tubo de escape hasta '83 r.o. 6053849</p>	 <p><b>974</b> SILICONA soporte tubo de escape desde '91 r.o. 6882943</p>	 <p><b>232</b> soporte tubo de escape desde '83 a '91 r.o. 6120254</p>
 <p><b>2756</b> SILICONA soporte tubo de escape desde '91 r.o. 6679949</p>	 <p><b>2418</b> SILICONA soporte tubo de escape desde '91 r.o. 6905927</p>	 <p><b>4269</b> GOMA soporte tubo de escape desde '91 r.o. 1022729</p>

## FORD ESCORT - ORION



**2419** **SILICONA**  
soporte tubo de escape motores Zetec  
r.o. 6831302



**2420**  
soporte tubo de escape Diesel-TurboD  
r.o. 6882943



**2788** **Ø 55 x 64 mm**  
junta cónica tubo de escape  
(alambre inox con mica), r.o. 6688868



**2431** **Ø 50 x 67 mm**  
junta cónica tubo de escape  
(alambre inox con mica), r.o. 6616584



**2432** **Ø 60 x 69 mm**  
junta cónica tubo de escape  
(alambre inox con mica), r.o. 6745092



**2433** **Ø 75x93 mm**  
junta cónica tubo de escape  
(alambre inox con mica), r.o. 6789153



**933**  
tuerca rueda  
r.o. 6069623



**418**  
cubrepedal freno y embrague  
r.o.

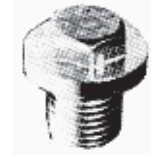

**669**  
tapón de cárter  
r.o. 1454117



**2020**  
arandela tapón de cárter nylon blanca  
(hasta '91), r.o.



**2024**  
arandela tapón de cárter con retén de goma  
(desde '91 hasta '96), r.o.



CANALIZACIONES DE AGUA:

FIESTA 950 (1976-1989)  
 FIESTA 1100 (1976-1989)  
 FIESTA 1300 (1976-1983)

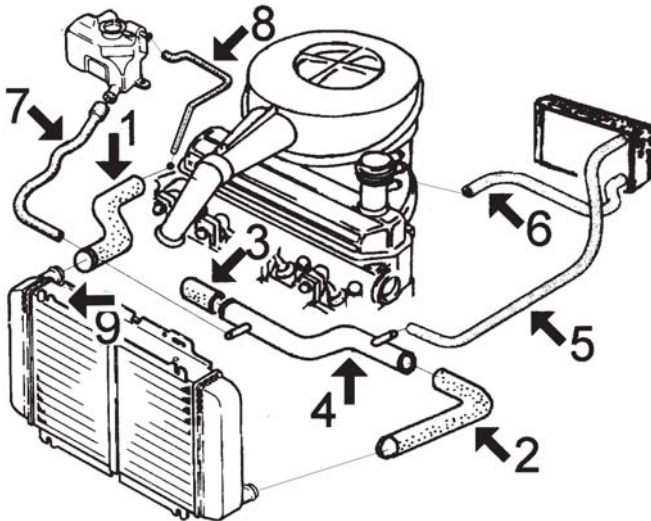

- 1- 7591 mgtto superior radiador 950-1100 '76 a '83  
 7574 mgtto superior radiador 950-1100 '83 a '89  
 n/d mgtto superior radiador 1300 hasta '83
- 2- 5972 mgtto inferior radiador 950-1100 '76 a '83  
 7575 mgtto inferior radiador 950-1100 '83 a '89  
 n/d mgtto inferior radiador 1300 hasta '83
- 3- 7545 mgtto tubo metálico a bomba de agua todos
- 4- n/d tubo metálico 950-1100 hasta '83  
 3014 tubo metálico 950-1100 desde '83 hasta '89  
 n/d tubo metálico 1300 hasta '83
- 5- 5988 mgtto de calefactor a tubo metálico 950-1100-1300
- 6- 7833 mgtto de calefactor a colector de admisión 950-1100-1300
- 7- 116 mgtto de botella a radiador 950-1100-1300 hasta '83: Cortar de rollo MC-116 Ø8x14 mm, longitud 1050 mm  
 8197 mgtto de botella a tubo metálico, 950-1100 desde '83 hasta '89
- 8- 7989 mgtto sobrante de botella a tapa de termostato, 950-1100 desde '83
- 9- 3607 tapón de radiador 0,7 bar

FIESTA 1300 modelo '83 (BL, 1983-1986) - 1600/XR2, (HL, 1983-1989) y  
 FIESTA 1400 modelo '86, (HL, 1986-1989),

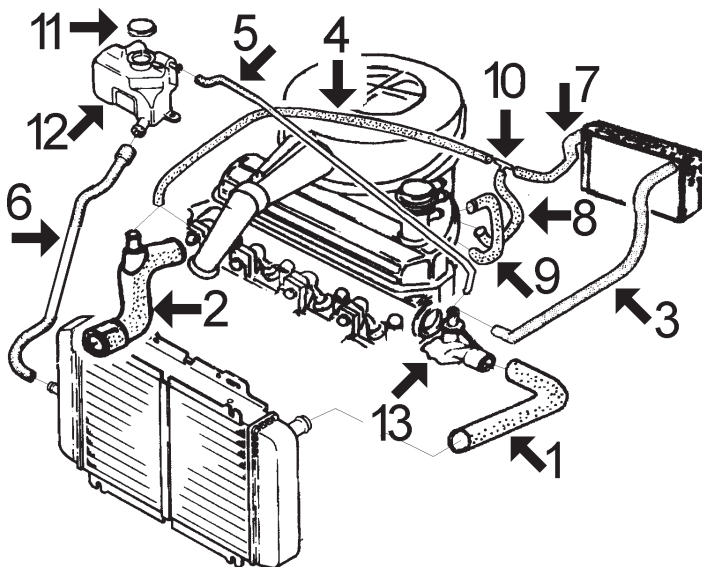

- 1- n/d mgtto superior radiador 1300-1400 y XR2
- 2- n/d mgtto inferior radiador 1300  
 8760 mgtto inferior radiador 1400 y XR2 (con boquilla para 3ª vía)
- 3- 7881 mgtto de calefactor a termostato 1300  
 8026 mgtto de calefactor a termostato 1400 y XR2
- 4- 7882 mgtto de bomba a racor empalme 1300 (1er tramo de bomba a calefactor)  
 118 mgtto de boquilla en mgtto inferior a racor de emalme 1400 y XR2 (1er. tramo de mgtto a calefact.)  
 Cortar de rollo MC-118 Ø13x19, long. 900 mm
- 5- 7301 mgtto de sobrante de botella a termostato
- 6- 8198 mgtto de botella a radiador
- 7- 8040 mgtto de racor empalme a calefactor
- 8- 8027 mgtto de racor empalme a colector (versiones sin starter automático)  
 8204 mgtto de racor empalme a carburador (versiones con starter automático)
- 9- 8203 mgtto de colector a carburador (sólo versiones con starter automático)
- 10- 2717 racor empalme mgttos calefacción
- 11- 3607 tapón botella expansión hasta '85 (metálico)  
 3561 tapón botella expansión desde '85 (plástico)
- 12- 3508 botella de expansión desde '85
- 13- n/d tapa de termostato

8360 juego mgttos degasificadores motores HL (1.4-1.6)

FIESTA 1600 Diesel (1984-1988)

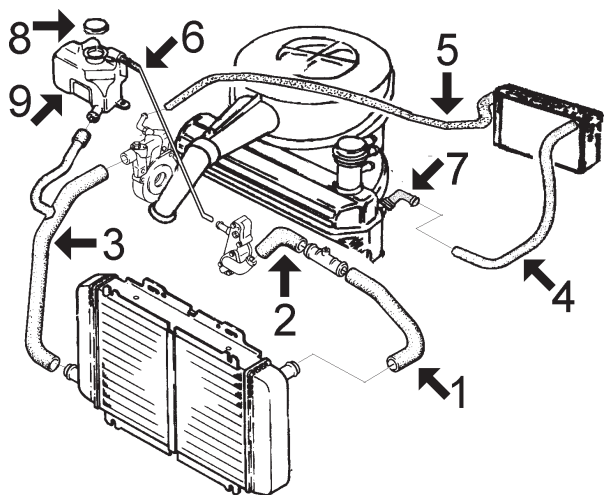

- 1- n/d mgto superior radiador, 1er. tramo
- 2- n/d mgto superior radiador, 2º tramo
- 3- n/d mgto inferior radiador hasta 4/'86
- n/d mgto inferior radiador desde 4/'86
- 4- 8031 mgto de calefactor a boquilla en culata
- 5- 8035 mgto de calefactor a bomba de agua
- 6- 7301 mgto de sobrante de botella a caja termostato
- 7- 3061 boquilla metálica roscada en culata
- 8- 3607 tapón botella de expansión hasta '85 (metálico)
- 3561 tapón botella de expansión desde '85 (plástico)
- 9- 3508 botella de expansión desde '85

FIESTA 1100 - 1300 (BL) modelo '89

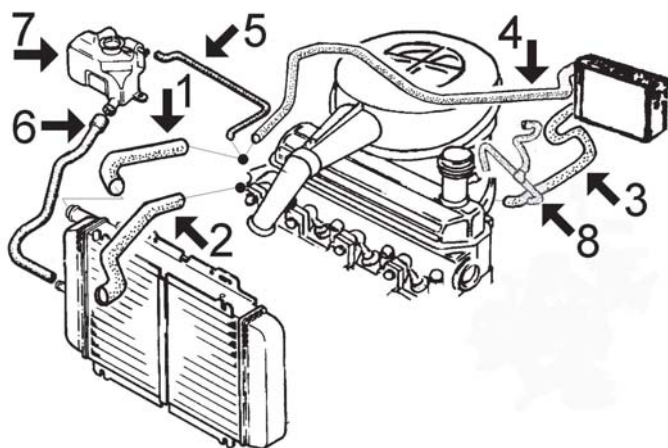

- 1- 7985 mgto superior de radiador 1.1 todos y 1.3 sin aire acondicionado
- 8786 mgto superior radiador 1.3 con aire acondicionado
- 2- 7986 mgto inferior de radiador 1.1 todos y 1.3 sin aire acondicionado
- 8787 mgto inferior radiador 1.3 con aire acondicionado
- 3- 8038 mgto de calefactor a colector de admisión
- 4- 8039 mgto de calefactor a tapa de termostato
- 5- 7989 mgto de sobrante de botella a termostato
- 6- 8198 mgto de botella a radiador
- 7- 3561 tapón botella de expansión
- 3509 botella de expansión
- 8- 8744 mgto de carburador/bloque inyector a colector

FIESTA 1400 - 1600 cc (HL) modelo '89, hasta 8/'96:

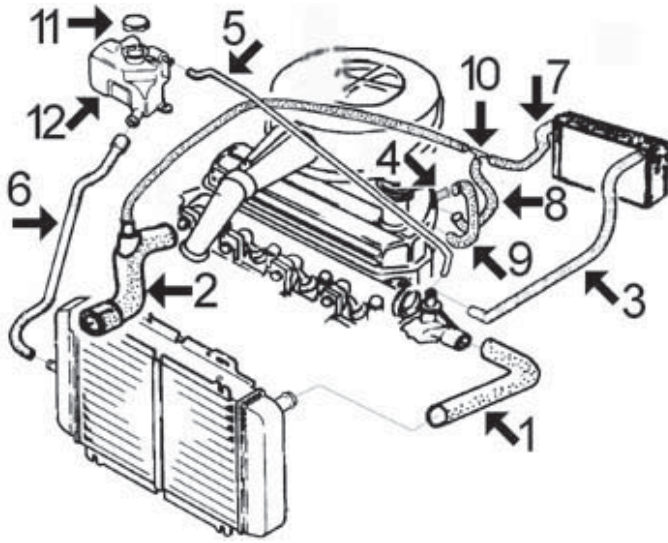

- 1- 7822 mgto superior radiador
- 2- 8760 mgto inferior radiador 1.4 sin aire acondicionado  
8745 mgto inferior radiador 1.4 con aire acondicionado hasta 1/'94  
8759 mgto inferior radiador 1.4 con aire acondicionado desde 1/'94
- 3- 8199 mgto de calefactor a termostato
- 4- 3061 boquilla en culata (codo, aluminio)  
3126 boquilla en culata (recta, aluminio)
- 5- 7301 mgto de sobrante de botella a tapa de termostato
- 6- 8197 mgto de botella a radiador
- 7- 8040 mgto de racor empalme a calefactor
- 8- 8027 mgto de racor empalme a colector de admisión
- 9- 8203 mgto de carburador a colector 1400, sólo versiones con stárter automático  
8204 mgto de carburador a colector 1600, sólo versiones con stárter automático
- 10- 2717 racor empalme tubos de calefacción
- 11- 3561 tapón botella de expansión (1,20 bar)
- 12- 3509 botella de expansión

8360 juego mgto desvaporizadores

FIESTA 1.8 DIESEL - COURIER de '89 hasta '96:

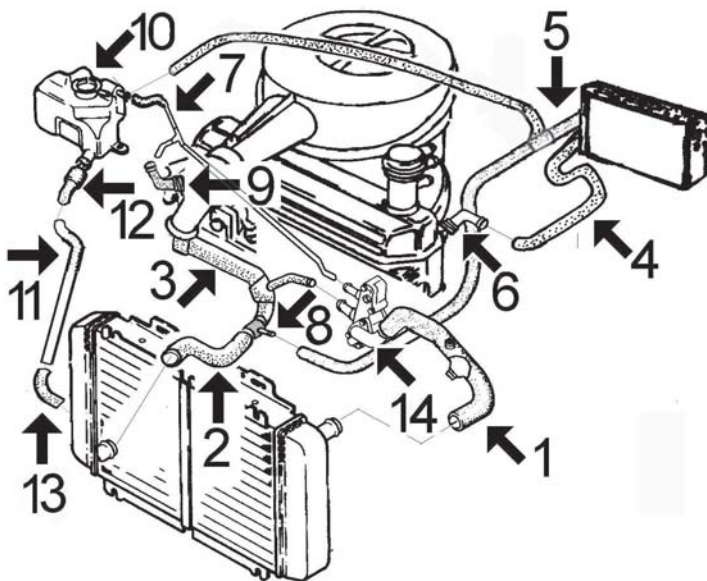

- 1- 7853 mgto superior radiador
- 2- 8276 mgto inferior radiador
- 3- 8138 mgto de bomba de agua a termostato y a racor empalme con mgto inferior de radiador
- 4- 8200 mgto de calefactor a boquilla roscada en culata
- 5- 8201 mgto de calefactor a racor empalme hasta 12/'93  
8761 mgto de calefactor a racor y botella desde 12/'93 (3 vias)
- 6- 3061 boquilla metálica roscada en culata (codo)  
3126 boquilla metálica roscada en culata (recta)
- 7- 8291 mgto de sobrante de botella a termostato
- 8- 3066 tubo de agua metálico en mgto inferior
- 9- 3149 racor en culata (banjo) Ø 8 mm
- 10- 3561 tapón botella de expansión  
3509 botella de expansión
- 11- n/d tubo metálico de botella a radiador hasta 12/'93
- 12- n/d mgto de botella a tubo metálico hasta 12/'93
- 13- 8027 mgto de tubo metálico a radiador hasta 12/'93
- 14- 3606 tapa de termostato  
4845 cuerpo de termostato con junta

8361 juego mgto desvaporizadores



**5972**  
mgto inferior radiador 0.9-1.1 hasta '83  
r.o. 6047976



**5988**  
mgto calefactor 0.9-1.1 hasta '89  
r.o. 1562615



**7301**  
mgto sobrante de botella  
r.o. 84FB8B08HF

FORD FIESTA '76 - '83 - '89 - COURIER '89



**7545**  
mgto de tubo metálico a bomba de agua  
r.o. 1562258



**7574**  
mgto superior radiador 0.9-1.1 mod. '83  
r.o. 6112689



**7575**  
mgto inferior radiador 0.9-1.1 mod. '83  
r.o. 6139472-6133570



**7591**  
mgto superior radiador 0.9-1.1 hasta '83  
r.o. 6051492



**7822**  
mgto superior radiador 1.4-1.6 modelo '89  
r.o. 6186120



**7833**  
mgto calefactor 0.9-1.1 hasta '89  
r.o. 6114422

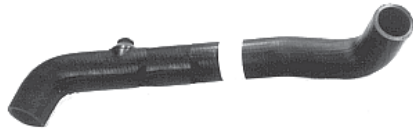

**7853**  
mgto superior radiador 1.8 D sin aire acond.  
r.o. 6182777



**7881**  
mgto calefactor 1.3 modelo '83  
r.o. 6146240



**7882**  
mgto calefactor 1.3 modelo '83  
r.o. 6160288



**7985**  
mgto superior radiador 1.1 modelo '89  
r.o. 6182772



**7986**  
mgto inferior radiador 1.1 modelo '89  
r.o. 6182778



**7989**  
mgto de sobrante de botella a termostato  
r.o. 6182763



**8026**  
mgto calefactor 1.4-1.6 modelo '83  
r.o. 6158021



**8027**  
mgto calefactor 1.4-1.6 modelo '83 y a co-lector,  
r.o. 6177356



**8031**  
mgto izqd. calefactor 1.6D  
r.o. 6143720-6163367



**8035**  
mgto dcho. calefactor 1.6 D  
r.o. 6146306-1644378

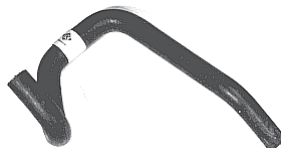

**8038**  
mgto calefactor 1.1 modelo '89  
r.o. 6186538



**8039**  
mgto calefactor 1.1 modelo '89  
r.o. 6178704





















**8040**  
mgto calefactor 1.4-1.6 mod. 89 2º tramo  
r.o. 6178705



**8138**  
mgto de bomba de agua 1.8 Diesel  
r.o. 6180942-6466032



FORD FIESTA '76 - '83 - '89 - COURIER '89

 <p><b>8197</b> mgto de botella a tubo rígido mod. '83 r.o. 6136053</p>	 <p><b>8198</b> mgto de botella a radiador mod. 1.4-1.6 '83 r.o. 6143587</p>	 <p><b>8199</b> mgto izqd. calefactor 1.4-1.6 modelo '89 r.o. 6179054-6164296</p>
 <p><b>8200</b> mgto izqd. calefactor 1.8 Diesel r.o. 6202491</p>	 <p><b>8201</b> mgto de calefactor a racor 1.8 Diesel r.o. 6202492</p>	 <p><b>8203</b> mgto de colector a carburador 1.3-1.4-1.6 (stárter automático), r.o. 6170465</p>
 <p><b>8204</b> mgto de racor a carburador (stárter auto- mático), r.o. 6179685</p>	 <p><b>8276</b> mgto inferior radiador 1.8 Diesel r.o. 6199865</p>	 <p><b>8291</b> mgto de sobrante de botella 1.8 Diesel r.o. 6550210</p>
 <p><b>8360</b> jgo mgto desvaporizadores 1.4-1.6 r.o. 6196128+6196127</p>	 <p><b>8361</b> jgo mgto desvaporizadores 1.8 Diesel r.o. 6179491+6162286</p>	 <p><b>8744</b> mgto de carburador a colector 1.3 BL r.o.</p>
 <p><b>8745</b> mgto inferior radiador 1.4 con aire acond. r.o.</p>	 <p><b>8759</b> mgto inferior radiador 1.4 con aire acond. r.o.</p>	 <p><b>8760</b> mgto inferior radiador 1.6 r.o.</p>
 <p><b>8761</b> mgto de calefactor a culata y botella 1.8D desde '93, r.o.</p>	 <p><b>8786</b> mgto superior radiador 1.3 con aire acond. r.o.</p>	 <p><b>8787</b> mgto inferior radiador 1.3 con aire acond. r.o.</p>

FORD FIESTA '76 - '83 - '89 - COURIER '89



**3508**  
botella de expansión desde '83 hasta '89  
r.o. 6181109



**3509**  
botella de expansión desde '89  
r.o. 1004005



**3561**  
tapón botella de expansión  
r.o. 7267962



**3607**  
tapón radiador/botella expansión hasta '85  
0,7 bar, r.o.



**3113**  
tapa de termostato 950-1100 desde '83 a '96  
r.o. 6814635



**3114**  
tapa de termostato 950-1100 hasta '83  
r.o. 6028494



**3606**  
tapa de termostato 1.8 Diesel  
r.o. 6189058



**3014**  
tubo de agua 950-1100 desde '83 a '89  
r.o. 6133569



**3066**  
tubo metálico enlace mgto inferior 1.8 D  
r.o. 6180946



**3061**  
boquilla roscada en culata 1.4-1.6 y Diesel  
r.o. 1592026



**3149**  
racor en culata 1.8 D (banjo de Ø 8 mm)  
r.o. 6720378

**¡Nuevo!**



**4845**  
cuerpo de termostato con junta 1.8 Diesel  
r.o. 1079905+1032504



**2717**  
racor empalme tubos de calefacción  
r.o. 6085829

SUSPENSION DELANTERA y SOPORTES DE MOTOR:

FIESTA todos modelos hasta '89

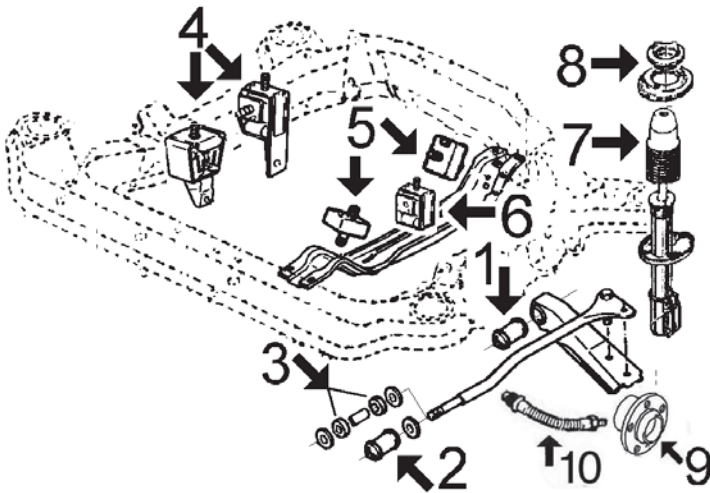

- 1- 429 silentbloc brazo delantero
- 2- n/d silentbloc tirante brazo hasta '83
- 3- 775 silentblocs (poliuretano) tirante brazo delantero desde '83 hasta '89
- 4- n/d soporte de motor derecho 950 y 1100 hasta '83
- 2484 soporte de motor derecho 950 y 1100 desde '83
- 929 soporte de motor derecho 1.4 y 1.6 XR2 desde modelo '83 y 1.6 Diesel desde '84 hasta '86
- 2368 soporte de motor derecho 1.6 Diesel desde '86
- 5- 441 soporte de motor delantero y trasero todos salvo 1.6 D desde '86
- 512 soporte de motor delt. y tras. 1.6 D desde '86
- 6- n/d soporte de motor izquierdo, sólo 1300 hasta '83
- 7- 475 capuchón amortiguador delantero
- 8- 2729 soporte amortiguador delantero desde '83
- 9- 90021 buje rueda delantera desde '83
- 10- 96040 latiguillo freno delantero (385 mm)

FIESTA / COURIER todos modelos desde '89 hasta '96

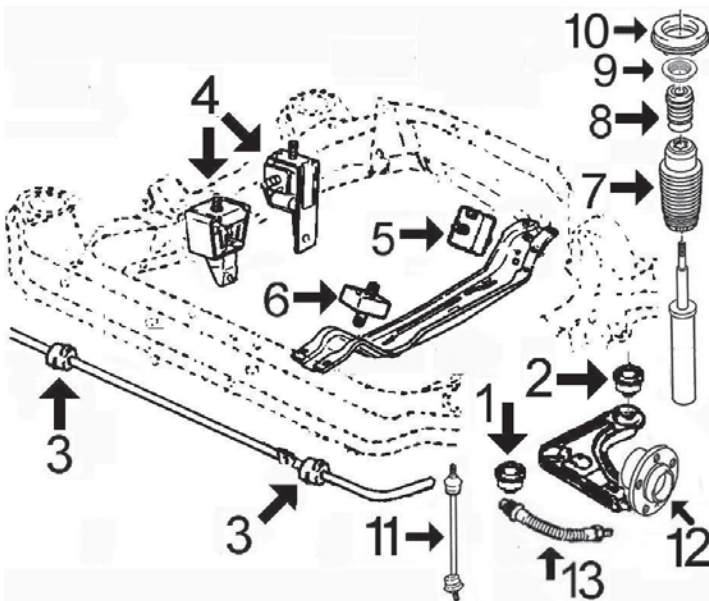

- 1- 980 silentbloc anterior trapecio delantero
- 2- 981 silentbloc posterior trapecio delantero
- 3- 2634 goma barra estabilizadora hasta '94, Ø 12 mm
- 2632 goma barra estabilizadora hasta '94, Ø 16 mm
- 2631 goma barra estabilizadora desde '94, Ø 16 mm
- 4- 513 soporte de motor derecho 1.1-1.3 (BL)
- 2688 soporte de motor derecho 1.4-1.6 (HL)
- 2624 soporte de motor derecho 1.8 Diesel
- 5- 441 soporte de motor delantero todos salvo Diesel
- 512 soporte de motor delantero 1.8 Diesel
- 6- 441 soporte de motor trasero todos salvo Diesel
- 833 soporte de motor trasero 1.8 Diesel
- 7- 2998 capuchón amortiguador delantero
- 8- 4265 tope de goma amortiguador delantero hasta 1/'94
- 2996 tope de goma amortiguador delantero desde 1/'94
- 9- 4211 rodamiento soporte amortiguador delantero
- 10- 2729 soporte amortiguador delantero
- 11- 4264 bieleta puntal barra estabilizadora 1.8 Diesel
- 4263 bieleta puntal barra estabilizadora 1.1-1.3-1.4 y 1.6 gasolina
- 12- 90022 buje rueda delantera hasta '94
- 90041 buje rueda delantera desde '94
- 10- 96055 latiguillo freno delantero (415 mm)

FORD FIESTA '76 - '83 - '89 - COURIER '89



**429**  
silentbloc brazo delantero hasta '89  
r.o. 1619120

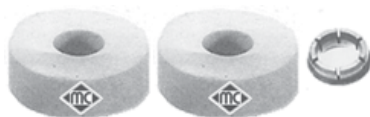

**775**  
jgo silentblocs tirante brazo (poliuretano)  
d/'83 hasta '89 r.o. 6140086 + 6154160



**980**  
silentbloc anterior trapecio delt. desde '89  
r.o: no hay despiece, trapecio completo



**981**  
silentbloc posterior trapecio delt. desde '89  
r.o: no hay despiece, trapecio completo



**2632** Ø 16 mm  
goma barra estabiliz. delantera hasta '94  
r.o. 6543416



**2631** Ø 16 mm  
goma barra estabiliz. delantera desde '94  
r.o. 7102392



**929**  
soporte de motor derecho 1.4-1.6 desde '83  
a '89, r.o. 1637005 - 1640021 - 6133404

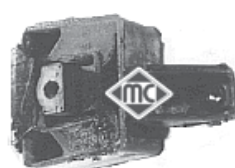

**2484** "pata corta"  
soporte motor derecho 950-1.1 de '83 a '89  
r.o. 1638511 - 6160228 - 6131375

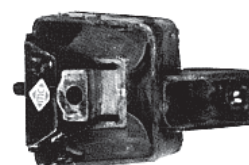

**513** "pata larga"  
soporte de motor derecho 1.6 D hasta '86  
r.o. 6161627 - 7229329 - 6517658



**2688**  
soporte de motor derecho 1.4-1.6 desde '89  
r.o. 6161628



**2368**  
soporte de motor derecho 1.6 Diesel  
r.o. 6160229



**2624**  
soporte de motor derecho 1.8 Diesel  
r.o. 6185027

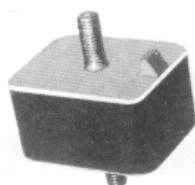

**441**  
soporte de motor delt. y tras. todos salvo  
Diesel, r.o. 6049904 - 6194624

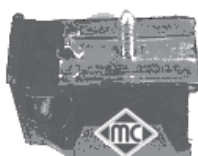

**512** tetones simétricos  
soporte de motor delt. y tras. 1.6 Diesel  
r.o. 6203710

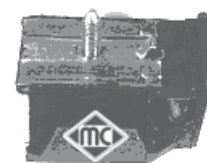

**833** tetones asimétricos  
soporte de motor trasero 1.8 Diesel  
r.o. 6170427 - 1661786



**2996**  
tope de goma suspensión delantera d/'94  
r.o. 6532212



**4265**  
tope de goma suspensión delantera desde  
'89 hasta '94, r.o. 6167869



**2998**  
capuchón amortiguador delant. desde '89  
r.o. 7379687



**4211**  
rodamiento soporte amortg. desde '89  
r.o. 6150276



**4263**  
bieleta puntal barra estabilizadora 1.1-1.3-1.4  
y 1.6 gasolina d/'89, r.o. 1661237 (240 mm)



**4264**  
bieleta puntal barra estabiliz. 1.8 Diesel  
desde '89 hasta '96, r.o. (262 mm)



FORD FIESTA '76 - '83 - '89 - COURIER '89



**2634** Ø 12 mm  
goma barra estabilizadora delantera y trasera  
r.o. 1652936-6046476



**475**  
capuchón amortiguador delantero h/ '89  
r.o. 145821-6136219



**2729**  
soporte amortiguador delantero desde '83  
r.o. 6150277



**2713**  
tirante eje trasero completo de '83 a '89  
r.o. 6051518



**2635** Ø 20 mm  
goma barra estabilizadora trasera  
r.o. 1659591



**2690**  
silentbloc brazo trasero desde '89  
r.o. 6745350



**90021**  
buje rueda delantera desde '83 hasta '89  
r.o. 1644842



**90022**  
buje rueda delantera desde '89 hasta '94  
r.o. 6517014

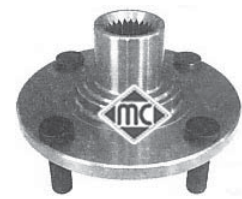

**90041**  
buje rueda delantera desde '94  
r.o. 6517013(3903036)



**96040**  
latiguillo freno delantero '83 a '89 (385 mm)  
r.o. 6114613



**96055**  
latiguillo freno delantero '89 a '95 (415 mm)  
r.o. 1021841



**96036**  
latiguillo freno trasero '76 a '89 (315 mm)  
r.o. 6049556

**¡Nuevo!**



**96047**  
latiguillo freno trasero '89 a '95 (340 mm)  
r.o. 6714710

FORD FIESTA '76 - '83 - '89 - COURIER '89

**¡Nuevo!**



**4820**  
polea cigüeñal 1.8 Diesel  
r.o.

**¡Nuevo!**



**4815**  
polea cigüeñal 1.8 Diesel  
r.o.

**¡Nuevo!**



**4849**  
juego retén eje y tapa cubo rueda trasera  
r.o. 1003554+1103509

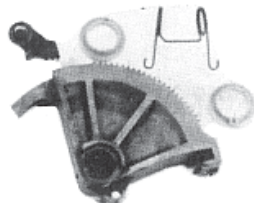

**325**  
serreta pedal embrague hasta '89  
r.o.

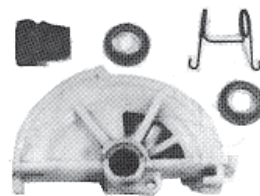

**519**  
serreta pedal embrague desde '89  
r.o. 6183029



**1197**  
fuelle cremallera asistida Fiesta '89-Courier  
r.o. 7138554



**1534**  
fuelle cremallera manual desde '83  
r.o. 6127744



**444**  
casquillo cremallera dirección  
r.o. 6076533



**2905**  
cruceta caña de dirección (desde '89)  
r.o. 7257202

**¡Nuevo!**



**3705**  
tapón llenado aceite Zetec-1.4/1.6 y 1.8D  
r.o. 71676665



**1341**  
kit rep. transmisión l/cambio 950-1.1  
r.o. 6028751

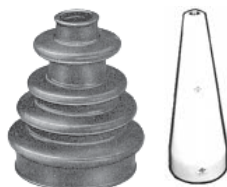

**1623E** para montar con cono  
kit rep. transmisión l/rueda 950-1.1  
r.o. 6028724



**1342E** para montar con cono  
kit rep transmisión l/rda 1.4-1.6 y Diesel  
r.o. 6043191



**4370**  
palanca de desembrague 1.8 Diesel  
r.o. 6737887

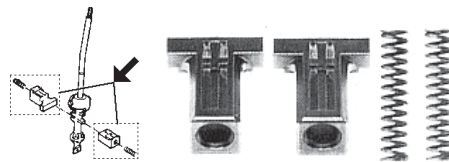

**2303**  
juego de casquillos palanca de cambio  
(5 veloc.) todos desde '87, r.o. 6172154



**247**  
soporte tubo de escape hasta '83  
r.o. 6053849



**232**  
soporte tubo de escape desde '83  
r.o. 6120254



**2756** **silicona**  
soporte tubo de escape desde '92-  
r.o. 6679949



**974** **silicona**  
soporte escape Fiesta '92 (motores Zetec)  
r.o. 6788494

FORD FIESTA '76 - '83 - '89 - COURIER '89



**2420**  
soporte tubo de escape Fiesta '92-  
r.o. 6882943



**2431**  $\text{Ø } 50 \times 67 \text{ mm}$   
junta cónica tubo de escape (mods. con ca-  
talizador), r.o. 6616584



**2433**  $\text{Ø } 75 \times 93 \text{ mm}$   
junta cónica tubo de escape (modelos con  
catalizador), r.o. 6789153



**2788**  $\text{Ø } 55 \times 64 \text{ mm}$   
junta cónica tubo de escape 1.8 D  
r.o. 6688868



**933**  
tuerca rueda  
r.o. 6069623



**418**  
cubrepedal freno y embrague  
r.o.



**669**  
tapón de cárter 14x150  
r.o. 6732529



**2020**  
arandela nylon blanca tapón de cárter  
r.o.



**2024**  
arandela tapón cárter con retén de goma  
(todos modelos desde '92), r.o.

CANALIZACIONES DE AGUA:

FIESTA - COURIER - PUMA 1.3i motor de gasolina HCS hasta 5/99:

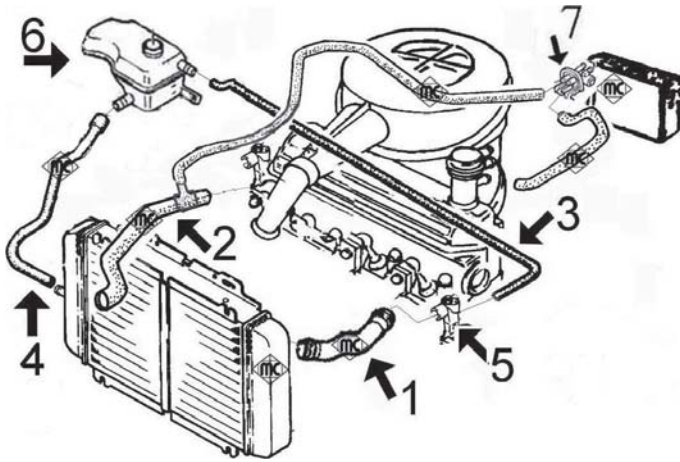

- 1- 8762 mgto superior radiador hasta 1/98  
8763 mgto superior radiador desde 1/98
- 2- 8783 mgto inferior radiador sin aire acondicionado (conjuntamente con mgto de calefacción)  
8764 mgto inferior radiador con aire acondicionado (conjuntamente con mgto de calefacción)
- 3- 8765 mgto de botella a tapa de termostato
- 4- 8766 mgto de botella a radiador
- 5- 3150 tapa de termostato hasta 1/98  
3142 tapa de termostato desde 1/98
- 6- 3561 tapón botella de expansión  
3576 botella de expansión
- 7- 4822 válvula de calefacción

FIESTA - COURIER - PUMA 1.25-1.4-1.6 motores de gasolina ZETEC-16v

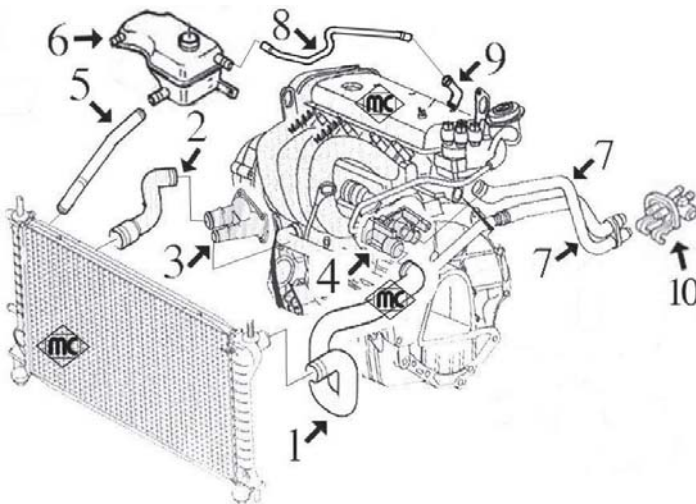

- 1- 8767 mgto superior radiador
- 2- 8768 mgto inferior radiador sin aire acondicionado  
8769 mgto inferior radiador con aire acondicionado
- 3- 3577 tapa de termostato
- 4- 4844 cuerpo aluminio conexión mgto
- 5- 8766 mgto de botella a radiador
- 6- 3576 botella de expansión  
3561 tapón botella de expansión
- 7- 8771 mgto doble de calefactor a culata y tapa de termost.  
8770 mgto de sobrante de botella a culata
- 8- 3126 boquilla en culata
- 9- 3126 boquilla en culata
- 10- 4822 válvula de calefacción

8778 jgo mgto desvaporizadores

FIESTA - COURIER - PUMA 1.3i motor de gasolina Duratec-8v EFI desde 5/99

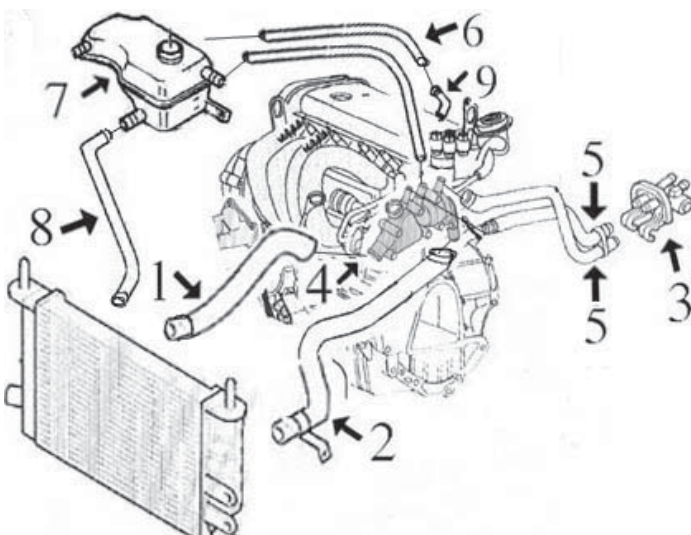

- 1- n/d mgto superior radiador
- 2- n/d mgto inferior radiador
- 3- 4822 válvula de calefacción
- 4- 3709 cuerpo completo con termostato, tapa y juntas
- 5- n/d jgo mgto de calefactor a cuerpo termostato
- 6- 8770 mgto de sobrante de botella a culata
- 7- n/d botella de expansión  
3561 tapón botella de expansión
- 8- 8766 mgto de botella a radiador
- 9- 3140 boquilla aluminio en culata



FIESTA - COURIER 1.8 Diesel motor Kent hasta 4/'99:

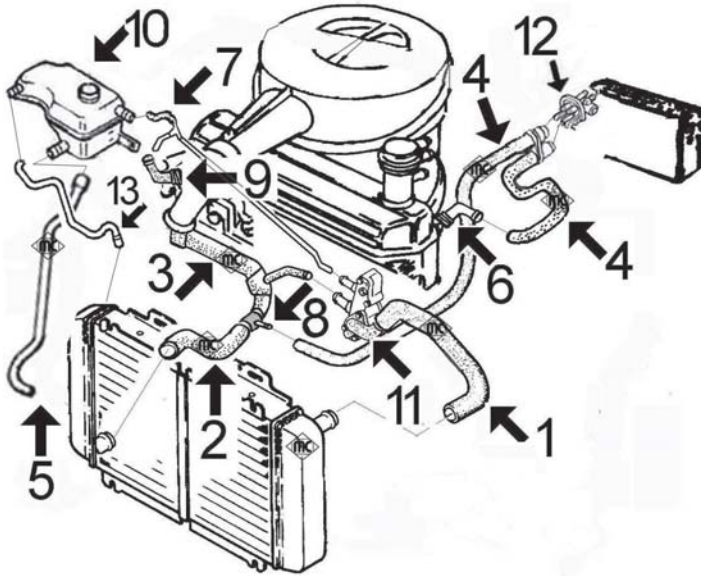

- 1- 8772 mgto superior radiador
- 2- 8773 mgto inferior radiador hasta 1/'99  
8774 mgto inferior radiador desde 1/'99
- 3- 8138 mgto de bomba de agua a tapa y tubo metálico
- 4- 8777 mgto doble de calefacción
- 5- 8766 mgto de botella a radiador
- 6- 3126 boquilla en culata, recta (alternativamente a 3061)  
3061 boquilla en culata, codo (alternativamente a 3126)
- 7- 8776 mgto de sobrante de botella a culata y caja termost.
- 8- 3066 tubo de agua metálico
- 9- 3149 boquilla en culata (alternativamente a 3152)  
3152 boquilla en culata (alternativamente a 3149)
- 10- 3576 botella de expansión  
3561 tapón botella de expansión
- 11- 4845 cuerpo de termostato  
3151 tapa de termostato
- 12- 4822 válvula de calefacción
- 13- 8775 mgto de sobrante de botella a radiador

FIESTA - COURIER 1.8 Diesel motor Lynx desde 4/'99:

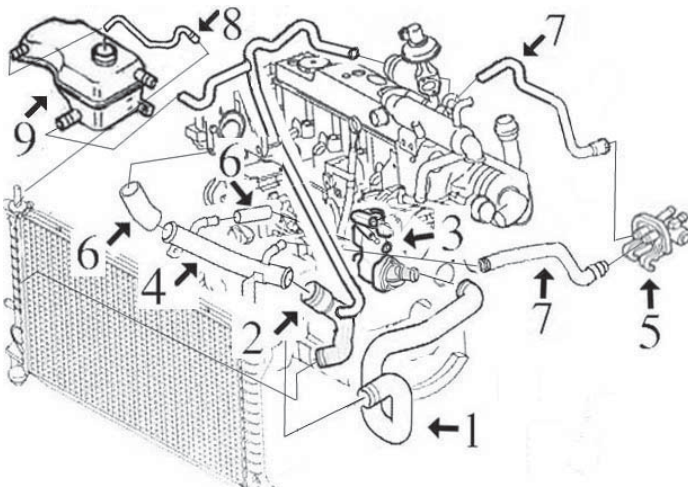

- 1- 9141 mgto superior radiador
- 2- 9142 mgto inferior radiador, a botella e intercambiador
- 3- 4845 cuerpo de termostato (aluminio)  
3151 tapa de termostato hasta
- 4- 3191 tubo de agua metálico
- 5- 4822 válvula de calefacción
- 6- 9131 jgo mgto de tubo metálico a bomba y a caja termost.
- 7- 9140 jgo mgto de entrada/salida calefactor  
3561 tapón botella de expansión
- 8- 8775 mgto de sobrante de botella a radiador
- 9- 3576 botella de expansión  
3561 tapón botella de expansión

FORD FIESTA / COURIER / PUMA 1996-2002



**8138**  
mgto de bomba agua a tubo 1.8 Diesel  
r.o. 6180942-6466032



**8762**  
mgto superior radiador 1.3i HCS hasta 1/98  
r.o.



**8763**  
mgto superior radiador 1.3i HCS desde 1/99  
r.o.



**8764**  
mgto inferior radiador 1.3i HCS con aire acondicionado, r.o.



**8765**  
mgto de botella a tapa termostato 1.3i HCS  
r.o.



**8766**  
mgto de botella a radiador 1.25-1.4 Zetec  
r.o.



**8767**  
mgto superior radiador 1.25-1.4 Zetec  
r.o.



**8768**  
mgto inferior radiador 1.25-1.4 Zetec sin aire acondicionado, r.o.



**8769**  
mgto inferior radiador 1.25-1.4 Zetec con aire acondicionado, r.o.



**8770**  
mgto de sobrante botella a bloque 1.25-1.4  
r.o.



**8771**  
mgto doble de calefactor a culata y tapa de termostato, r.o.



**8772**  
mgto superior radiador 1.8 Diesel  
r.o.



**8773**  
mgto inferior radiador 1.8 Diesel hasta 2/99  
r.o.



**8774**  
mgto inferior radiador 1.8 Diesel desde 2/99  
r.o.



**8775**  
mgto de botella a radiador 1.8 Diesel  
r.o.



**8776**  
mgto de sobrante botella a tapa termostato 1.8 Diesel, r.o.



**8777**  
mgto doble de calefacción 1.8 Diesel  
r.o.



**8778**  
jgo mgto desvaporizadores 1.4 Zetec  
r.o.



**8783**  
mgto inferior radiador 1.3i HCS sin aire acondicionado, r.o.



**9131**  
jgo mgto de tubo metálico a bomba y caja de termostato 1.8D, r.o.



**9140**  
jgo mgto calefactor 1.8 Diesel Lynx  
r.o.

FORD FIESTA / COURIER / PUMA 1996-2002



**9141**  
mgto superior radiador 1.8D Lynx  
r.o.



**9142**  
mgto inferior radiador 1.8D Lynx  
r.o.



**3061**  
boquilla en culata 1.8 Diesel Kent  
r.o. 1592026



**3066**  
tubo de agua metálico 1.8 Diesel Kent  
r.o. 6180946



**3126**  
boquilla en culata 1.8 Diesel Kent (aluminio), r.o. 6148087-6733022



**3140**  
boquilla en culata 1.25-1.4 Zetec  
r.o. 1008789



**3149**  
boquilla en culata 1.8 Diesel Ø 8 mm  
r.o. 6720378



**3142**  
tapa de termostato 1.3i desde 1/98  
r.o. 1027596



**3150**  
tapa de termostato 1.3i hasta 5/98  
r.o. 1002815



**3151**  
tapa de termostato 1.8 Diesel  
r.o. 1031904



**3152**  
boquilla en culata 1.8 Diesel Ø 8 mm  
r.o. 6574963

**¡Nuevo!**



**3191**  
tubo de agua metálico 1.8D Lynx  
r.o.



**3561**  
tapón botella de expansión  
r.o. 7267962



**3576**  
botella de expansión todos mods.  
r.o. 1018016-1102678



**3577**  
tapa de termostato 1.25/1.4/1.6 Zetec  
r.o. 1112977-1072177

**¡Nuevo!**



**3709**  
cuerpo con termostato completo 1.3 Duratec desde 5/99, r.o. 1149691+1148164

**¡Nuevo!**

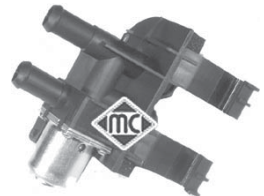

**4822**  
válvula de calefacción  
r.o. 1085638-1047752

**¡Nuevo!**



**4844**  
caja entrada agua 1.4/1.6 Zetec con junta  
r.o. 1098780-1141206-1301772-1221325

**¡Nuevo!**



**4845**  
cuerpo de termostato 1.8 Diesel hasta 8/02  
r.o. 1079905-1131995



SUSPENSION DELANTERA y SOPORTES DE MOTOR:

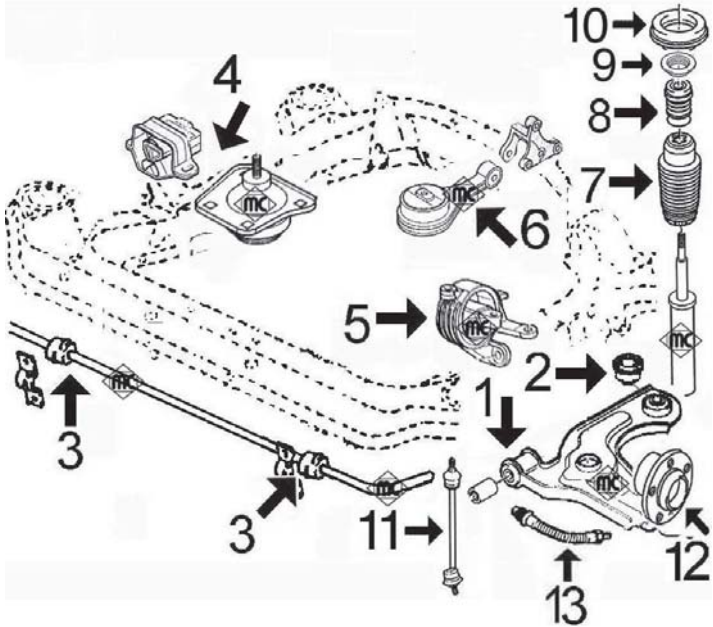

- 1- 2828 silentbloc anterior trapecio delantero
- 2- 2829 silentbloc posterior trapecio delantero
- 3- 4267 goma para barra estabiliz. de Ø 15 mm -Fiesta  
2631 goma para barra estabiliz. de Ø 16 mm -Courier
- 4- 4000 soporte motor derecho 1.25/1.4/1.6 gasolina  
5066 soporte motor derecho 1.3 Duratec desde 5/'99  
2999 soporte motor derecho Diesel
- 5- 4001 soporte motor izquierdo
- 6- 4002 soporte motor trasero gasolina  
4003 soporte motor trasero diesel
- 7- 2998 capuchón amortiguador delantero
- 8- 2996 tope de goma amortiguador delantero
- 9- 4210 rodamiento soporte amortiguador delantero
- 10- 4018 soporte superior amortiguador delantero
- 11- 4263 bieleta puntal barra estabilizadora
- 12- 90041 buje rueda delantera
- 13- 96055 latiguillo freno delantero (415 mm)

SUSPENSION TRASERA berlina (NO Courier):

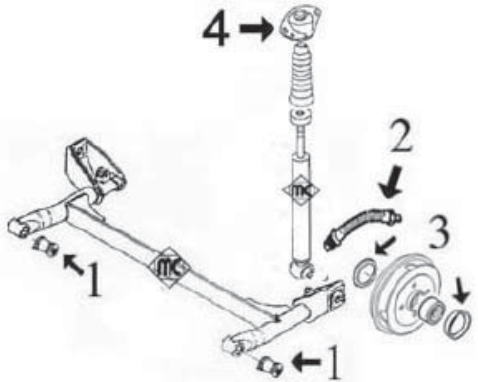

- 1- 4836 silentbloc soporte puente tras. Fiesta (no Courier)
- 2- 96062 latiguillo freno trasero (335 mm)
- 3- 4849 juego retén y tapa cubo rueda trasera
- 4- 4032 soporte amortiguador trasero



**2631**  
goma barra estabilizadora Courier Ø 16 mm  
r.o. 7102392



**2828**  
silentbloc anterior trapecio delantero  
r.o. 1010037



**2829**  
silentbloc posterior trapecio delantero  
r.o. 1014654



**2996**  
tope de goma amortiguador delantero  
r.o. 6532212



**2998**  
capuchón amortiguador delantero  
r.o. 7379687



**2999**  
soporte motor derecho 1.8 Diesel  
r.o. 1060402



FORD FIESTA / COURIER / PUMA 1996-2002



**4000**  
soporte motor derecho gasolina  
r.o. 1060401



**4001**  
soporte motor izquierdo  
r.o. 1010530



**4002**  
soporte motor trasero gasolina  
r.o. 1055171



**4003**  
soporte motor trasero 1.8 Diesel  
r.o. 1059003



**4018**  
soporte amortiguador delantero  
r.o. 1013794



**4032**  
soporte amortiguador trasero  
r.o. 1023587



**4210**  
rodamiento soporte amortiguador del.  
r.o. 1002513



**4263**  
bioleta puntal barra estabilizadora  
r.o. 1130273-1067818-1661237



**4267**  
goma barra estabilizadora Fiesta Ø 16 mm  
r.o. 1003609



**4836**  
silentbloc soporte puente trasero (excepto  
Courier), r.o. 1016439



**4849**  
juego retén y tapa cubo rueda trasera  
r.o. 1003554+1103509



**5066**  
soporte motor derecho 1.3 desde '99  
(motor Duratec), r.o. 1091516

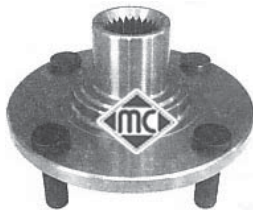

**90041**  
buje rueda delantera  
r.o. 6517013 (3903036)



**96055**  
latiguillo freno delantero (425 mm)  
r.o. 1021841



**96062**  
latiguillo freno trasero (335 mm)  
r.o. 1014204

FORD FIESTA / COURIER / PUMA 1996-2002

<p><b>4847</b> polea cigueñal motor Zetec 1.25-1.4-1.6 r.o. 1087320</p>	<p><b>4852</b> polea cigueñal Puma 1.6 desde 1/00 r.o. 1087321</p>	<p><b>4838</b> polea cigueñal 1.8 Diesel hasta 4/99 r.o. 1005817</p>
<p><b>4853</b> polea cigueñal 1.8 Diesel desde 4/99 a 8/99 r.o. 1106411</p>	<p><b>4818</b> polea cigueñal 1.8 Diesel motor Lynx des- de 8/99, r.o. 1100051</p>	
<p><b>3705</b> tapón llenado aceite 1.4/1.6/1.8 Diesel r.o. 7167665-1018103</p>	<p><b>4887</b> tensor correa alternador 1.8 Diesel Lynx ('99-) r.o. 1079392</p>	
<p><b>1534</b> fuelle cremallera manual r.o. 6935233</p>	<p><b>442</b> casquillo cremallera manual r.o. 6076533</p>	<p><b>1197</b> fuelle cremallera asistida r.o. 1012814</p>
<p><b>2816</b> silentbloc pistón cremallera asistida r.o. 6180930</p>	<p><b>1075</b> kit rep. transmisión l/rueda 1.3 BL r.o.</p>	<p><b>1342E</b> kit rep. transmisión l/rda 1.25-1.4 Zetec y Diesel, r.o. 1016760 -montaje con cono-</p>
<p><b>1186</b> kit rep. transmisión l/cambio hasta '97 r.o. 1005597</p>	<p><b>1079</b> kit rep. transmisión l/cambio desde '97 r.o.</p>	<p><b>2757</b> soporte tubo de escape Courier r.o. 7092700</p>
<p><b>2418</b> soporte tubo de escape r.o. 6905927</p> <p>SILICONA</p>	<p><b>2419</b> soporte tubo de escape r.o. 6831302</p> <p>SILICONA</p>	<p><b>4269</b> soporte tubo de escape r.o. 1022729</p> <p>GOMA</p>

FORD FIESTA / COURIER / PUMA 1996-2002



**4270**  
soporte tubo de escape  
r.o.



**418**  
cubrepedal freno y embrague  
r.o.6168375



**669**  
tapón cárter de aceite hasta 5/98  
r.o.1663906



**2024**  
arandela tapón de cárter con retén de  
de goma, r.o.



**2903**  
tapón de cárter desde 5/98 con junta  
r.o.1013938



**2021**  
arandela tapón de cárter desde 5/98  
r.o.1005593

SUSPENSION DELANTERA y SOPORTES DE MOTOR:

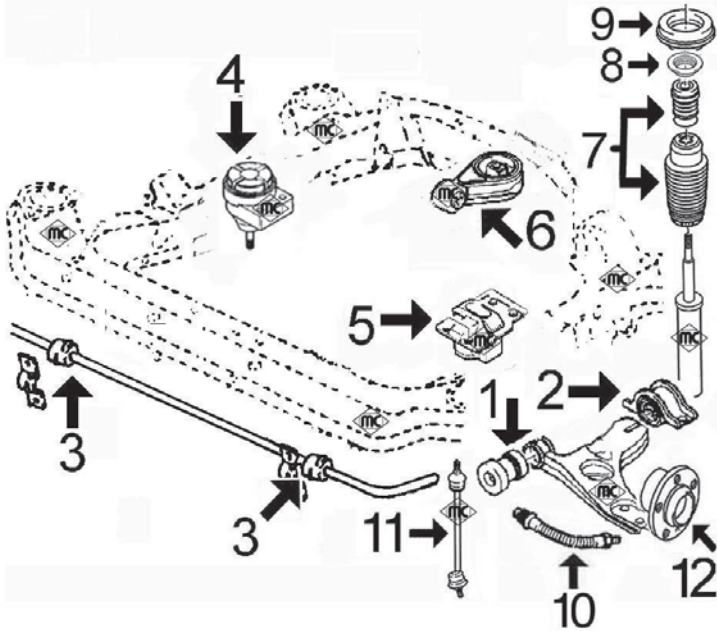

- 1- 4877 silentbloc anterior trapecio delantero
- 2- 4878 silentbloc posterior trapecio delantero
- 3- 4854 goma barra estabilizadora
- 4- 4105 soporte motor derecho
- 5- 4851 soporte motor izquierdo
- 6- 4850 soporte motor trasero
- 7- 4897 juego tope poliuretano y capuchón amortiguador
- 8- 4898 rodamiento soporte amortiguador
- 9- 4882 soporte amortiguador delantero
- 10- 96054 latiguillo freno delantero (520 mm)
- 11- 4855 bieleta puntal barra estabilizadora
- 12- n/d buje de rueda delantera



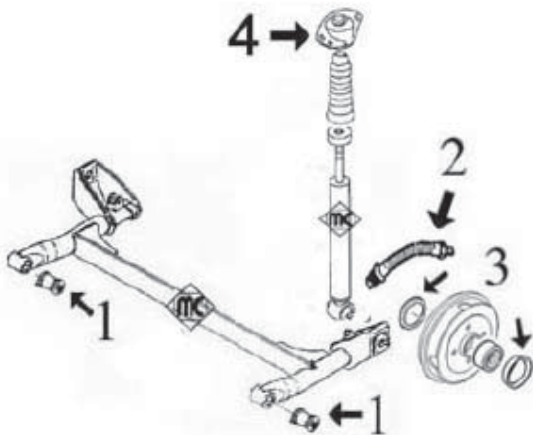









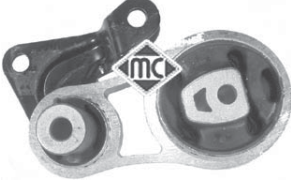



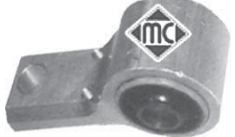

SUSPENSION TRASERA:



- 1- 4843 silentbloc soporte puente trasero
- 2- 96057 latiguillo freno trasero (320 mm)
- 3- 4849 juego retén y tapa cubo rueda trasera
- 4- n/d soporte amortiguador trasero



## FORD FIESTA '02 - FUSION

 <p><b>4105</b> soporte motor derecho r.o.</p>	 <p><b>4843</b> silentbloc puente trasero r.o. 1146160</p>	 <p><b>4849</b> juego retén y tapa cubo de rueda trasero r.o. 1003554+1103509</p>
 <p><b>4850</b> soporte motor trasero r.o.</p>	 <p><b>4851</b> soporte motor izquierdo r.o.</p>	 <p><b>4854</b> goma barra estabilizadora r.o. 1152852</p>
 <p><b>4855</b> bieleta puntal barra estabilizadora r.o. 1146150</p>	 <p><b>4877</b> silentbloc anterior trapecio delantero r.o.</p>	 <p><b>4878</b> silentbloc posterior trapecio delantero r.o.</p>
 <p><b>4882</b> soporte amortiguador delantero r.o.</p>	 <p><b>4897</b> juego capuchón y tope amortiguador delt. r.o.</p>	 <p><b>4898</b> rodamiento en soporte amortiguador delt. r.o.</p>
 <p><b>96054</b> latiguillo freno delantero (520 mm) r.o. 1201141</p>	 <p><b>96057</b> latiguillo freno trasero (320 mm) r.o. 1217819</p>	
 <p><b>3140</b> boquilla en culata 1.4-1.6 (aluminio) r.o.</p>	 <p><b>3561</b> tapón botella de expansión r.o. 7267962</p>	 <p><b>3577</b> tapa de termostato 1.4-1.6 Zetec-S r.o.</p>
 <p><b>3703</b> botella de expansión r.o. 1141512-1141514</p>	 <p><b>3716</b> caja de termostato completa 1.3i-Duratec r.o. 1149691+1149620</p>	 <p><b>4844</b> caja agua aluminio 1.4-1.6 Zetec-S r.o.</p>

## FORD FIESTA '02 - FUSION

 <p><b>8778</b> jgo mgto desvaporizadores 1.4-1.6 r.o.</p>	 <p><b>3642</b> tapón llenado aceite 1.4 TdCi r.o.1147687</p>	 <p><b>418</b> cubrepedal freno y embrague r.o.</p>
 <p><b>4848</b> polea cigüeñal 1.4 Zetec-S r.o.</p>	 <p><b>4852</b> polea cigüeñal 1.6 Zetec-S r.o.</p>	 <p><b>4441</b> polea cigüeñal 1.4 TdCi r.o.</p>
 <p><b>1298</b>      Ø 31-74 mm kit rep. transmisión l/rueda 1.3-1.4-1.6 r.o.</p>	 <p><b>1373</b>      Ø 24-73 mm kit rep. transmisión l/rueda 1.3-1.4-1.6 r.o.</p>	 <p><b>2378</b>      Ø 19-67 mm kit rep. transmisión l/rueda 1.4 TdCi r.o.</p>
 <p><b>1145</b>      Ø 21-60 mm kit rep. transmisión l/cambio 1.3-1.4-1.6 r.o.</p>	 <p><b>1049</b>      Ø 29-62 mm kit rep. transmisión l/cambio 1.3-1.4-1.6 r.o.</p>	 <p><b>1142</b>      Ø 19-60 mm kit rep. transmisión l/cambio 1.4 TdCi r.o.</p>
 <p><b>1141</b> fuelle cremallera dirección r.o.4330628</p>	 <p><b>2903</b> tapón cárter aceite con junta de goma r.o.1013938</p>	 <p><b>2021</b> junta de goma tapón de cárter r.o.</p>
 <p><b>2426</b> soporte escape r.o.1142851</p>		

## CANALIZACIONES DE AGUA:

### Focus 1.4-1.6 gasolina, motores Zetec-S:

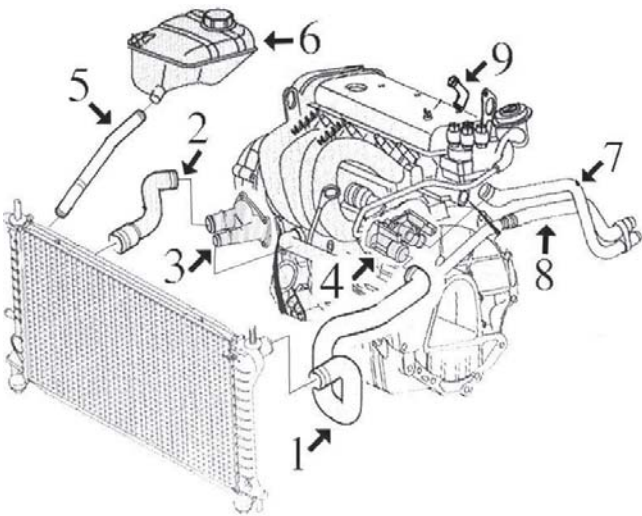

- 1- 9123 mgto superior radiador
- 2- 9124 mgto inferior radiador
- 3- 3577 tapa de termostato
- 4- 4844 caja de agua (aluminio)
- 5- 9125 mgto de botella a radiador
- 6- 3565 botella de expansión  
3561 tapón botella de expansión
- 7- 9133 mgto de calefactor a caja de agua
- 8- 9132 mgto de calefactor a tapa de termostato
- 9- 3140 boquilla en culata (aluminio)

8778 jgo mgts desvaporizadores

### Focus 1.8/16v-2.0/16v gasolina, motores Zetec-E:

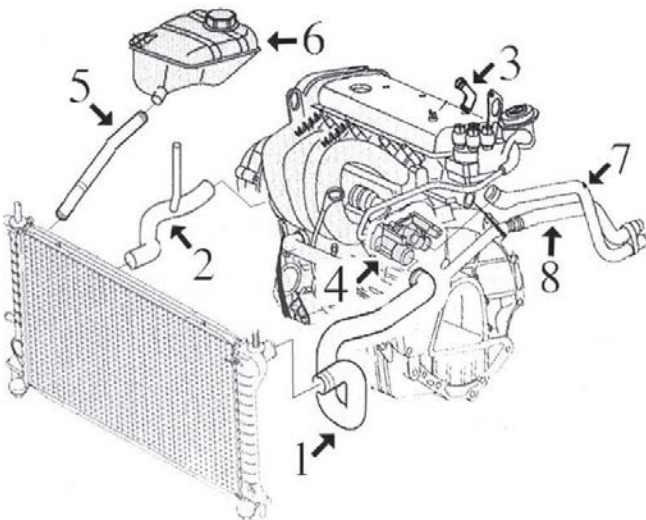

- 1- 9129 mgto superior radiador
- 2- 9130 mgto inferior radiador
- 3- 3140 boquilla en culata (aluminio)
- 4- 3562 tapa de termostato
- 5- 9125 mgto de botella a radiador
- 6- 3744 botella de expansión  
3561 tapón botella de expansión
- 7- n/d mgto de calefactor a caja de agua
- 8- n/d mgto de calefactor a tapa de termostato

### Focus 1.8 Diesel motor Lynx:

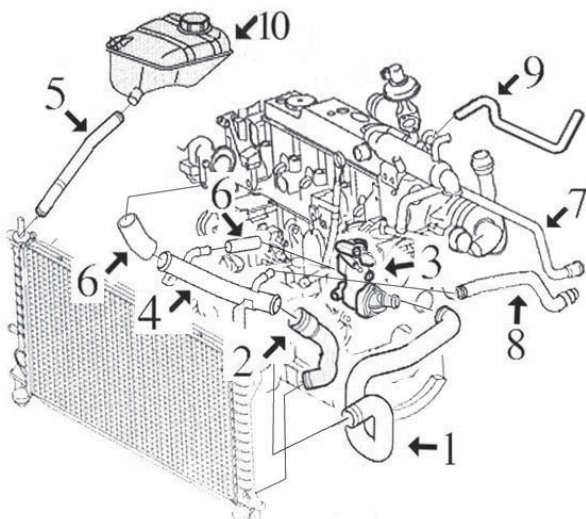

- 1- 9126 mgto superior radiador
- 2- 9127 mgto inferior radiador
- 3- 4845 cuerpo de termostato hasta 8/'02 (aluminio)  
3151 tapa de termostato hasta 8/'02 (aluminio)  
3713 cuerpo completo con termostato y tapa desde 8/'02
- 4- 3191 tubo de agua metálico
- 5- 9125 mgto de botella a radiador
- 6- 9131 jgo mgts de tubo metálico a bomba y caja termost.
- 7- 9135 mgto de calefactor a intercambiador en filtro aceite
- 8- 9134 mgto de calefactor a tubo, 1.er tramo  
3192 mgto de calefactor a tubo, 2º tramo (tubo metálico con manguito que empalma en tubo n° 4)
- 9- 9128 mgto a intercambiador en filtro de aceite
- 10- 3744 botella de expansión  
3561 tapón botella de expansión



## FORD FOCUS



**8778**  
jgo mgto desvaporizadores 1.4-1.6  
r.o.

**iNuevo!**



**9123**  
mgto superior radiador 1.4-1.6  
r.o.

**iNuevo!**



**9124**  
mgto inferior radiador 1.4-1.6  
r.o.

**iNuevo!**



**9125**  
mgto de botella a radiador todos mods.  
r.o.

**iNuevo!**



**9126**  
mgto superior radiador 1.8 Diesel  
r.o.

**iNuevo!**



**9127**  
mgto inferior radiador 1.8 Diesel  
r.o.

**iNuevo!**



**9128**  
mgto a intercambiador 1.8 Diesel  
r.o.

**iNuevo!**



**9129**  
mgto superior radiador 1.8-2.0 gasolina  
r.o.

**iNuevo!**



**9130**  
mgto inferior radiador 1.8-2.0 gasolina  
r.o.

**iNuevo!**



**9131**  
juego mgto de tubo metálico a caja 1.8D  
r.o.

**iNuevo!**



**9132**  
mgto de calefactor a tapa termostato 1.4-1.6  
r.o.

**iNuevo!**



**9133**  
mgto de calefactor a caja agua 1.4-1.6  
r.o.

**iNuevo!**



**9134**  
mgto de calefactor a tubo 1.8 Diesel  
r.o.

**iNuevo!**



**9135**  
mgto de calefactor a intercambiador 1.8D  
r.o.



**3140**  
boquilla en culata 1.4-1.6 (aluminio)  
r.o.



**3151**  
tapa de termostato 1.8 Diesel  
r.o.

**iNuevo!**

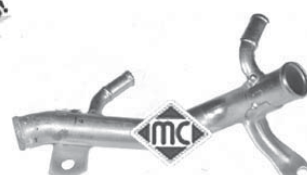

**3191**  
tubo de agua metálico 1.8 Diesel  
r.o.



**3192**  
tubo metálico con mgto de calefactor 1.8D  
r.o.



**3561**  
tapón botella de expansión  
r.o. 7267962



**3562**  
tapa de termostato 1.8-2.0  
r.o. 1052405



## FORD FOCUS



**3565**  
botella de expansión 1.4-1.6  
r.o. 1091364

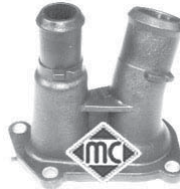

**3577**  
tapa de termostato 1.4-1.6  
r.o.

**¡Nuevo!**



**3709**  
caja termostato completa 1.3Rocam ('03-)  
r.o. 1149691+1149620

**¡Nuevo!**



**3713**  
caja de termostato completa 1.8D desde 8/02  
r.o.

**¡Nuevo!**

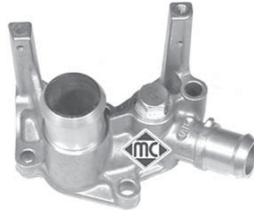

**4844**  
caja agua aluminio 1.4-1.6 con junta  
r.o.

**¡Nuevo!**



**4845**  
caja de termostato 1.8Diesel hasta -8/02  
r.o.

**¡Nuevo!**



**3744**  
botella de expansión 1.8-2.0 y 1.8Diesel,  
r.o. 1104120

SUSPENSION DELANTERA y SOPORTES DE MOTOR

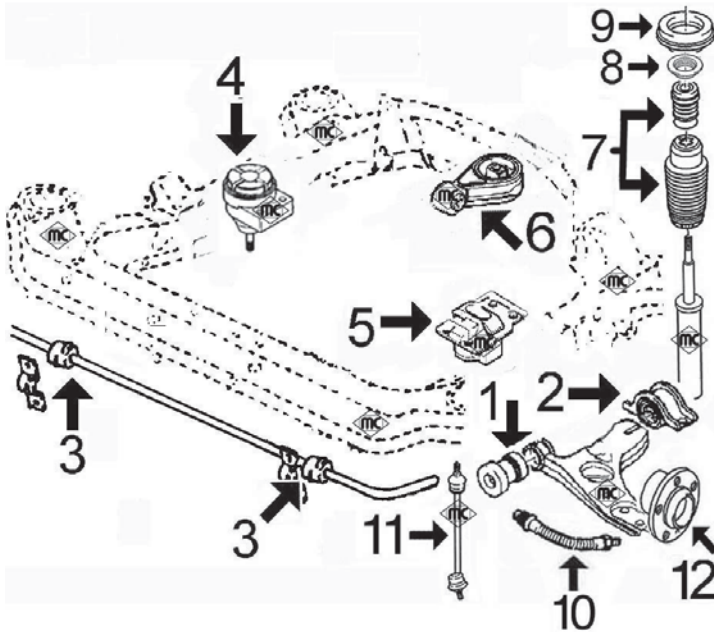

- 1- 4020 silentbloc anterior trapecio delantero
- 2- 4021 silentbloc posterior trapecio delantero
- 3- 4213 goma barra estabilizadora
- 4- 4105 soporte motor derecho 1.4 y 1.6 (Zetec S)
- 4107 soporte motor derecho 1.8 y 2.0 (Zetec E)
- 4108 soporte motor derecho 1.8 Diesel TdDi
- 5- 4104 soporte motor izquierdo
- 6- 4106 soporte motor trasero
- 7- 4876 juego tope poliuretano y capuchón amortiguador
- 8- 4207 rodamiento soporte amortiguador
- 9- 4111 soporte amortiguador delantero
- 10- 96082 latiguillo freno delantero (370 mm)
- 11- 4160 bieleta puntal barra estabilizadora
- 12- 90041 buje de rueda delantera (salvo "RS")
- 90060 buje de rueda delantera "RS"

SUSPENSION TRASERA

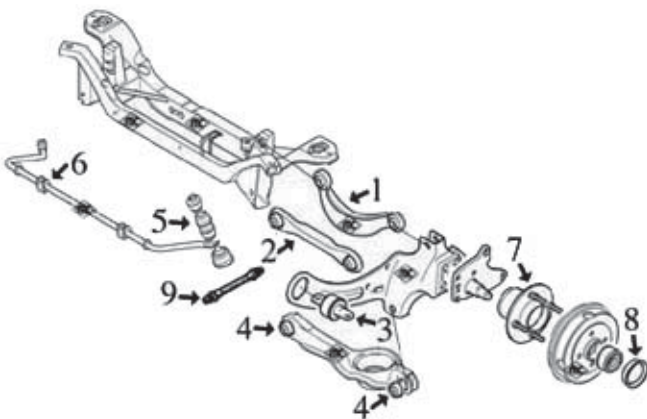

- 1- 4939 brazo superior completo
- 2- 4938 tirante inferior completo
- 3- 4256 silentbloc mangueta trasera
- 4- 4940 juego silentblocs brazo inferior
- 5- 4885 bieleta puntal barra estabilizadora trasera
- 6- 4941 goma barra estabilizadora trasera
- 7- 90515 buje rueda trasera completo con rodamiento
- 8- 4849 juego tapa tambor trasero
- 9- 96084 latiguillo freno trasero (223 mm)

## FORD FOCUS



**4020**  
silentbloc anterior trapecio delantero  
r.o. 1061570



**4021**  
silentbloc posterior trapecio delantero  
r.o. no hay despiece (va con trapecio)

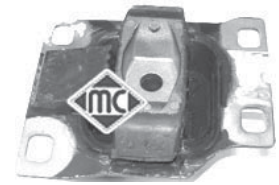

**4104**  
soporte motor izquierdo  
r.o. 1133019



**4105**  
soporte motor derecho 1.4-1.6 (Zetec S)  
r.o. 1139257

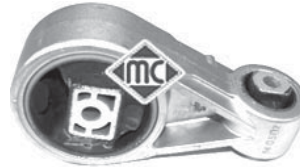

**4106**  
soporte motor trasero  
r.o. 1094591



**4107**  
soporte motor derecho 1.8-2.0 (Zetec E)  
r.o. 1112025



**4108**  
soporte motor derecho 1.8 Diesel TdDi  
r.o. 1142702



**4111**  
soporte amortiguador delantero  
r.o. 1087177



**4160**  
bieleta puntal barra estabilizadora (reemplaza la de aluminio, anulada en FORD)



**4207**  
rodamiento soporte amortiguador delantero  
r.o. 1115132



**4213**  
goma barra estabilizadora delantera  
r.o. 1073217

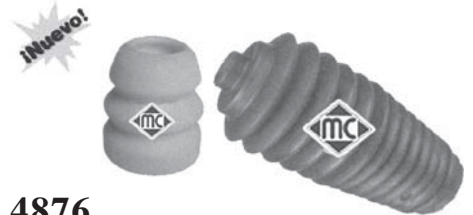

**4876**  
juego tope poliuretano y capuchón amortg.  
r.o.



**4019**  
goma barra estabilizadora trasera  
r.o. 1073249



**4256**  
silentbloc portamangueta trasera  
r.o. no hay despiece, solo brazo completo



**4849**  
juego tapa cubo rueda trasera  
r.o.



**4885**  
bieleta puntal barra estabilizadora trasera  
r.o. 1070175-1061713-1061702



**4940**  
juego silentblocs brazo inferior trasero  
r.o. montan en brazo 1064128



**4938**  
tirante inferior suspensión trasera  
r.o. 1061668



**4939**  
brazo superior suspensión trasera completo  
r.o. 1061659



**4941**  
goma barra estabilizadora trasera  
r.o. 1073249

## FORD FOCUS



**90041**

buje rueda delantera 1.4-1.6-2.0-Diesel (salvo "RS"), r.o. 3903036



**90060**

buje rueda delantera Focus "RS" r.o. 7346525



**90515**

buje rueda trasera con rodamiento r.o.



**96082**

latiguillo freno delantero (370 mm) r.o. 1068964



**96084**

latiguillo freno trasero (223 mm) r.o. 1064257



**¡Nuevo!**



**4852**

polea cigüeñal 1.4-1.6 (Zetec S) r.o.

**¡Nuevo!**



**4817**

polea cigüeñal 1.8-2.0 (Zetec-E) r.o.

**¡Nuevo!**



**4818**

polea cigüeñal 1.8 Diesel r.o.

**¡Nuevo!**



**3704**

tapón llenado aceite motor 1.8 Diesel r.o.

**¡Nuevo!**



**3705**

tapón llenado aceite motor 1.4-1.6 r.o.



**2903**

tapón cárter de aceite con junta de goma r.o. 1013938



**2021**

arandela tapón cárter de aceite r.o. 1005593

**¡Nuevo!**



**4752**

tensor correa alternador con polea de rueda libre, 1.8 Diesel de 100 y 115CV, r.o. 1151207

**¡Nuevo!**



**4887**

tensor correa alternador 1.8 Diesel de 75 y 90CV, r.o. 1334133



**1351**

fuelle cremallera dirección (asistida) r.o.



**1298**

kit rep transmisión l/rueda r.o.



**1049**

kit rep transmisión l/cambio r.o.



**4168**

soporte tubo de escape r.o.



**4270**

soporte tubo de escape r.o.



**418**

cubrepedal freno y embrague r.o.



## CANALIZACIONES DE AGUA

SHARAN motores 1.9 TDi y 2.0 gasolina hasta 2000:

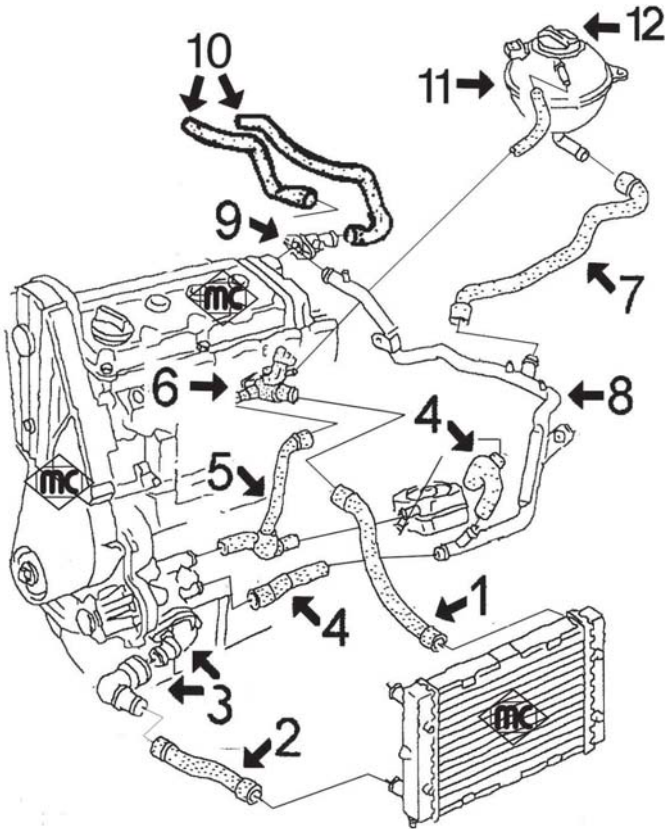

- 1- 8889 mgtto superior radiador
- 2- 8890 mgtto inferior radiador
- 3- 3667 boquilla en bomba de agua hasta '01  
3597 boquilla en bomba de agua desde '01
- 4- 8891 juego mgtos de tubo metálico a intercambiador y de tubo metálico a bomba de agua
- 5- 8394 mgtto de bomba de agua a brida en culata e intercambiador 2.0 gasolina  
8382 mgtto de bomba de agua a brida en culata e intercambiador 1.9TDi de 90cv  
8893 mgtto de bomba de agua a brida en culata e intercambiador 1.9TDi de 110cv
- 6- 3522 brida en culata conexión mgtos 2.0 gasolina  
3542 brida en culata conexión mgtos 1.9TDi
- 7- 8894 mgtto de tubo metálico a botella
- 8- 3170 tubo de agua metálico 2.0 gasolina  
3168 tubo de agua metálico 1.9TDi
- 9- 3517 boquilla en culata hasta '00  
3591 boquilla en culata 1.9TDi desde '00
- 10- 8892 juego mgtos entrada/salida calefactor
- 11- 3649 botella de expansión
- 12- 3650 tapón botella de expansión

## MANGUITOS DESVAPORIZADORES 1.9TDi y 2.0 gasolina

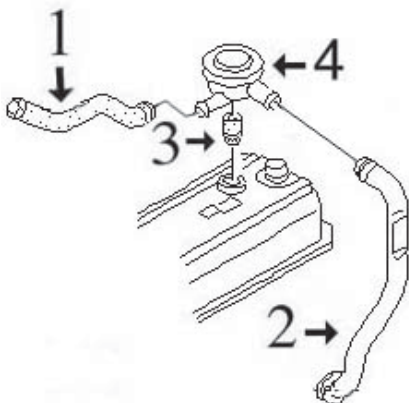

- 1- 8895 mgtto desvaporizador
- 2- 3644 tubo plástico desvaporizador 1.9TDi  
n/d tubo plástico desvaporizador 2.0 gasolina
- 3- 2669 junta válvula desvaporizadora
- 4- 3719 válvula desvaporizadora

## FORD GALAXY



**8382**  
mgto de bomba a brida en culata 1.9TDi de 90cv, r.o.



**8394**  
mgto de bomba a brida en culata 2.0 r.o.



**8889**  
mgto superior radiador 1.9TDi y 2.0 r.o.



**8890**  
mgto inferior radiador 1.9TDi y 2.0 r.o.



**8891**  
jgo mgto de tubo metálico a bomba de agua y a intercambiador, r.o.



**8892**  
jgo mgto entrada/salida calefactor r.o.



**8893**  
mgto de bomba a brida en culata 1.9TDi de 110cv, r.o.



**8894**  
mgto de tubo metálico a botella expansión r.o.



**8895**  
mgto desvaporizador 1.9TDi y 2.0 r.o.



**3168**  
tubo de agua metálico 1.9TDi r.o. 7M0121065AA/AE

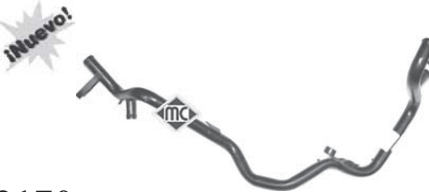

**3170**  
tubo de agua metálico 2.0 gasolina r.o. 7M0121065AF



**3517**  
boquilla en culata 2.0 y 1.9TDi hasta '00 r.o. 026121145E



**3522**  
brida frontal en culata 2.0 gasolina r.o.



**3542**  
brida frontal en culata 1.9TDi r.o.



**3591**  
boquilla en culata 1.9TDi desde '00 r.o.



**3597**  
boquilla en culata 2.0 y 1.9TDi desde '00 r.o. 06A121121C



**3644**  
tubo plástico desvaporizador 1.9Diesel r.o. 028103491J



**3649**  
botella de expansión r.o. 7M0121407A-7M3121407A



**3650**  
tapón botella de expansión r.o. 7M0121321C-7M3121321C



**3667**  
boquilla en bomba de agua completa r.o. 037121619+037121121A

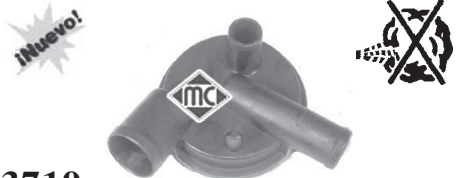

**3719**  
válvula desvaporizadora 1.9TDi-2.0 r.o. 028129101D



## CANALIZACIONES de AIRE de ALTA PRESION INTERCOOLER-TURBO:

SHARAN 1.9 Diesel motores TDi desde 9/'95 a 2/'00:  
(AHU-1Z-AFN-AVG)

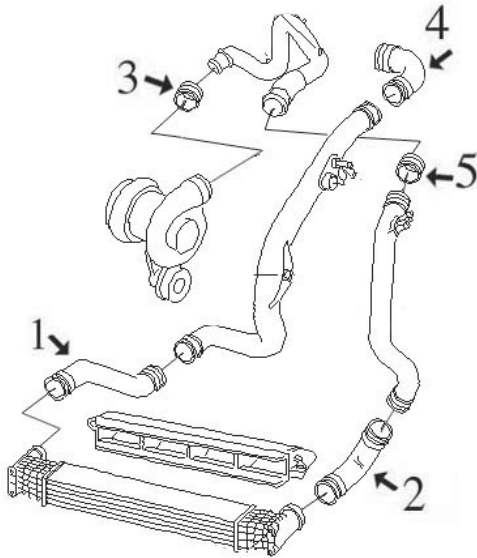

- 1- n/d tubo flexible de tubo a intercooler
- 2- n/d tubo flexible de tubo a intercooler
- 3- 9062 tubo flexible de turbo a tubo rígido
- 4- n/d tubo de colector a tubo rígido
- 5- 9061 tubo flexible de empalme

**¡Nuevo!**



**9061** Ø 50x60 largo 58 mm  
tubo flexible de alta presión  
r.o. 1H0145834E

**¡Nuevo!**



**9062** Ø 35x45 largo 58 mm  
tubo flexible de alta presión  
r.o. 3A0145972A

# FORD GALAXY

## SUSPENSION DELANTERA y SOPORTES DE MOTOR:

SHARAN todos tipos desde '96 hasta '01:

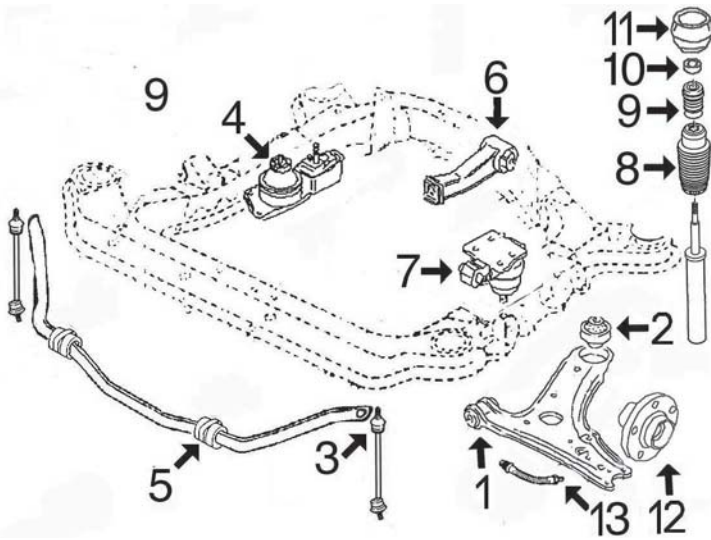

- 1- 4279 silentbloc anterior trapecio delantero
- 2- 4280 silentbloc posterior trapecio delantero
- 3- 4261 bieleta puntal barra estabilizadora
- 4- 4556 soporte motor derecho
- 5- 4555 goma barra estabilizadora
- 6- 4559 soporte motor trasero 1.9TDi de 90cv y 2.0 4560 soporte motor trasero 1.9TDi de 110cv y 1.8T
- 7- 4557 soporte motor izquierdo
- 8- 4324 capuchón amortiguador delantero
- 9- 4254 tope poliuretano amortiguador delantero
- 10- 4128 rodamiento soporte amortiguador
- 11- 2812 soporte amortiguador completo con rodamiento
- 12- 90064 buje rueda delantera
- 13- 96069 latiguillo freno delantero (500 mm)

SHARAN todos tipos desde '01:

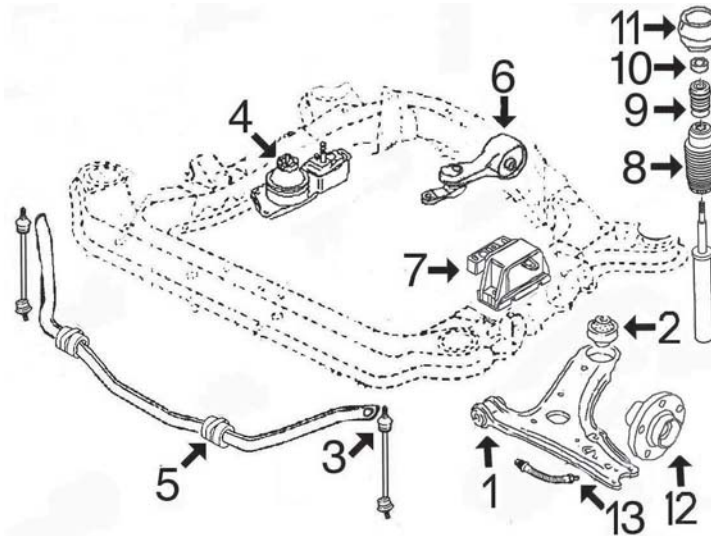

- 1- 4279 silentbloc anterior trapecio delantero
- 2- 4280 silentbloc posterior trapecio delantero
- 3- 4261 bieleta puntal barra estabilizadora
- 4- 4556 soporte motor derecho
- 5- 4555 goma barra estabilizadora
- 6- 4561 soporte motor trasero
- 7- 4558 soporte motor izquierdo
- 8- 4324 capuchón amortiguador delantero
- 9- 4298 tope poliuretano amortiguador delantero
- 10- 4128 rodamiento soporte amortiguador
- 11- 2812 soporte amortiguador completo con rodamiento
- 12- 90064 buje rueda delantera
- 13- 96069 latiguillo freno delantero (500 mm)

## SUSPENSION TRASERA:

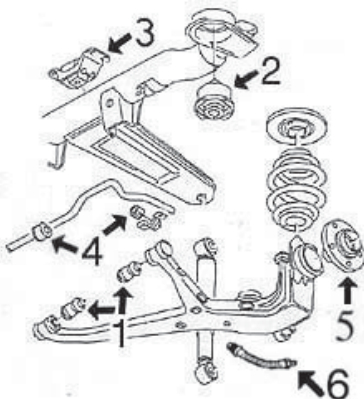

- 1- 4279 silentbloc trapecio suspensión trasera
- 2- n/d silentbloc sub-chasis trasero
- 3- 4603 soporte travesía suspensión trasera
- 4- 4618 juego gomas barra estabilizadora trasera
- 5- 90064 buje rueda trasera
- 6- 96070 latiguillo freno trasero (185 mm)



## FORD GALAXY



**4128**  
rodamiento soporte amortiguador delantero  
r.o. 1J0412249



**2812**  
soporte amortiguador delantero completo  
r.o.



**4254**  
tope poliuretano amortiguador delantero  
hasta '01, r.o.



**4261**  
bieleta puntal barra estabilizadora  
r.o. 7M0411317D



**4279**  
silentbloc anterior trapecio delantero y sus-  
pensión trasera, r.o. 7M0501541



**4280**  
silentbloc posterior trapecio delantero  
r.o. 7M0407181A



**4298**  
tope poliuretano amortiguador delantero  
r.o. 1H0412303B



**4324**  
capuchón amortiguador delantero  
r.o. 357413175

**¡Nuevo!**



**4555**  
goma barra estabilizadora delantera  
r.o. 7M0411031

**¡Nuevo!**

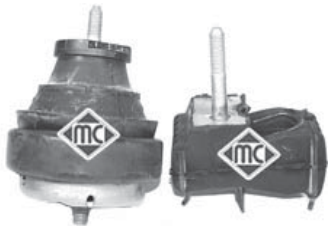

**4556**  
soporte motor derecho  
r.o. 7M0199132AH/AA/M/T/R

**¡Nuevo!**



**4557**  
soporte motor izquierdo hasta '01  
r.o. 7M0199131AP/AF

**¡Nuevo!**



**4558**  
soporte motor izquierdo desde '01  
r.o. 7M3199555B/R/K

**¡Nuevo!**



**4559**  
soporte motor trasero 1.9TDi (90cv) y 2.0  
r.o. 7M0399201BR/BT

**¡Nuevo!**



**4560**  
soporte motor trasero 1.9TDi (110cv) y 1.8T  
r.o. 7M0399201BQ/CC

**¡Nuevo!**



**4561**  
soporte motor trasero todos desde '01  
r.o. 7M3399201H/J/K/G

**¡Nuevo!**



**4603**  
soporte traviesa suspensión trasera  
r.o. 7M0555221C

**¡Nuevo!**



**4618**  
juego gomas barra estabilizadora trasera  
r.o. 7M0511413A+7M0555414B



**90064**  
buje rueda delantera y trasera  
r.o. 7M0501655D



**96069**  
latiguillo freno delantero (500 mm)  
r.o. 7M0611701D



**96070**  
latiguillo freno trasero (185 mm)  
r.o. 7M0611776B/C

## FORD GALAXY



**1321**  
fuelle izqdo. y dcho. cremallera  
r.o. 7M3422831



**1225**  
kit fuelle transmisión lado rueda  
r.o. 7M0498203-7M0498203A



**1069**  
kit fuelle transmisión lado cambio  
r.o. 7M0498201



**3568**  
guía varilla nivel aceite 1.8T  
r.o. 06A103663B

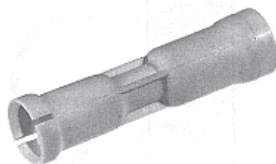

**2448**  
guía varilla nivel aceite 2.0 hasta '99  
r.o. 053103663



**3553**  
guía varilla nivel aceite 2.0 desde '99  
r.o. 06A103663C



**2876**  
guía varilla nivel aceite 1.9 TDi (salvo ANU)  
r.o. 028103663B



**3571**  
guía varilla nivel aceite 1.9 TDi (ANU)  
r.o. 038103663



**4760**  
varilla nivel aceite 1.9TDi-2.0  
r.o. 027115611C



**4290**  
polea cigüeñal 1.9 D-TD-TDi hasta '99  
r.o. 028105243T



**4421**  
polea cigüeñal 1.9 TDi desde '99-  
r.o. 038105243K

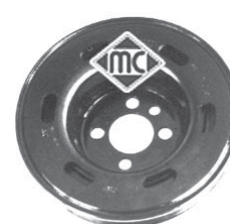

**4405**  
polea cigüeñal 1.8T-2.0 gasolina  
r.o. 06A105243E



**4768**      **Ø 78 mm**  
rodillo tensor correa alternador 1.9TDi-2.0  
r.o. 028145278E

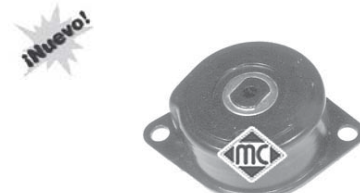

**4908**  
tensor correa alternador 1.9TDi hasta '99  
r.o. 028903315R



**4909**  
tensor correa alternador 2.0 gasolina  
hasta '99, r.o. 037903315C

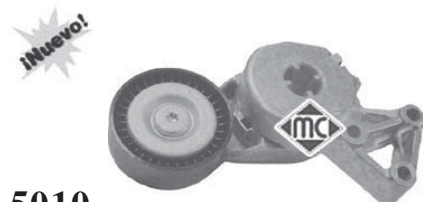

**5010**  
tensor correa alternador 1.8 desde '00-  
r.o. 06A903315E



**4919**      **Ø 55/50 mm, H=40,5 mm**  
polea de alternador de rueda libre  
r.o. 028903119AA



**4999**      **Ø 61/55 mm, H=41 mm**  
polea de alternador de rueda libre  
r.o. 038903119



**4997**      **Ø 61/55 mm, H=41 mm**  
polea de alternador de rueda libre  
r.o. 038903119T













**3672**  
válvula filtro gasoil 1.9D hasta '99  
r.o. 191127247A

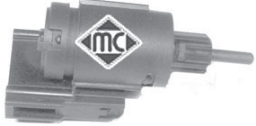

**3689**  
válvula filtro gasoil 1.9D desde '99  
r.o. 1J0127247-247A -247E

## FORD GALAXY

 <p><b>4365</b> jgo. tornillo sujeción tapa cubremotor r.o.028103665+028103937+028103638G</p>	 <p><b>864</b> cubrepedal freno y embrague r.o.321721173</p>	 <p><b>2669</b> junta válvula desvaporizadora r.o.028103500</p>
<p><i>¡Nuevo!</i></p>  <p><b>3731</b> interruptor luz de freno (4 polos) hasta 12/'02 r.o. 1J0945511A</p>	<p><i>¡Nuevo!</i></p>  <p><b>3739</b> interruptor luz de freno (2 polos) r.o. 191945511A/B</p>	<p><i>¡Nuevo!</i></p>  <p><b>3738</b> interruptor luz de freno (4 polos) desde 12/'02, r.o. 1J0945511C/D</p>
 <p><b>2426</b> soporte tubo de escape r.o. 1H0253147B</p>	 <p><b>674</b> tapón cárter de aceite hasta '98 (salvo V6) r.o. N90288901</p>	 <p><b>2916</b> tapón cárter de aceite desde '98 (salvo V6) r.o. N90813201</p>
 <p><b>2780</b> junta colector escape 1.9 TDi r.o.028129589B</p>	 <p><b>3621</b> tapón llenado aceite motor r.o.06B103485B</p>	

CANALIZACIONES DE AGUA:

KA motor HCS 1.3i (hasta '03)

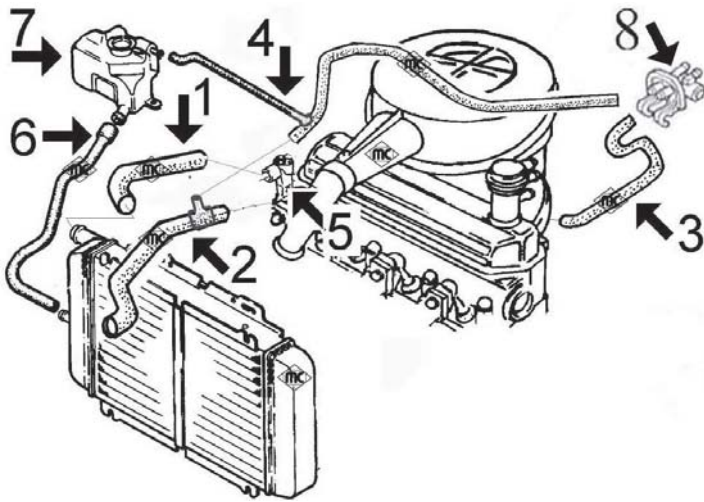

- 1- 8344 mgto superior de radiador
- 2- 8345 mgto inferior de radiador
- 3- 8784 mgto de calefactor a colector de admisión
- 4- 8815 mgto de calefactor a mgto inferior y botella
- 5- 3142 tapa de termostato
- 6- 8785 mgto de botella a radiador
- 7- 3561 tapón botella de expansión
- 3668 botella de expansión
- 8- 4822 válvula de calefacción



**8344**  
mgto superior radiador  
r.o. 1041733-1043768



**8345**  
mgto inferior radiador  
r.o. 1041732-1043766



**8784**  
mgto de calefactor a colector de admisión  
enchufe rápido, r.o.



**8785**  
mgto de botella a radiador  
r.o.



**8815**  
mgto de calefactor a mgto inferior y botella  
r.o.



**3142**  
tapa de termostato  
r.o. 1027596



**3561**  
tapón botella de expansión  
r.o. 7257962

**¡Nuevo!**



**3668**  
botella de expansión  
r.o. 1025999-1107521

**¡Nuevo!**



**4822**  
válvula de calefacción  
r.o. 1047752-1085638

**¡Nuevo!**



**3709**  
cuerpo completo con termostato motor 1.6  
Rocam (desde '03), r.o. 1149691+1149620



SUSPENSION DELANTERA y SOPORTES DE MOTOR

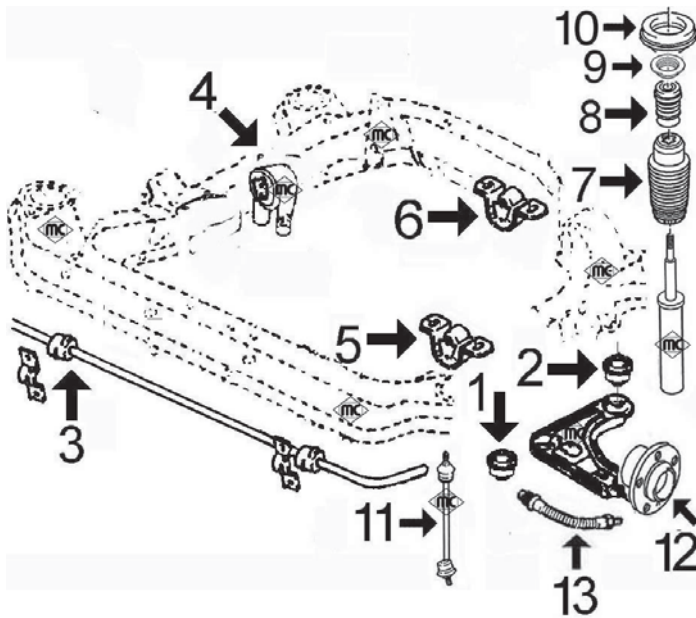

- 1- 980 silentbloc anterior trapecio delantero
- 2- 981 silentbloc posterior trapecio delantero
- 3- 2631 goma barra estabilizadora (Ø 16 mm)
- 4- 4161 soporte motor derecho
- 5- 4109 soporte motor izquierdo
- 6- 4216 soporte motor trasero
- 7- 2998 capuchón amortiguador
- 8- 2996 tope goma suspensión delantera
- 9- 4210 rodamiento soporte amortiguador
- 10- 4018 soporte amortiguador delantero
- 11- 4263 bieleta puntal barra estabilizadora
- 12- 90041 buje de rueda delantera
- 13- 96074 latiguillo freno delantero (530 mm)

SUSPENSION TRASERA

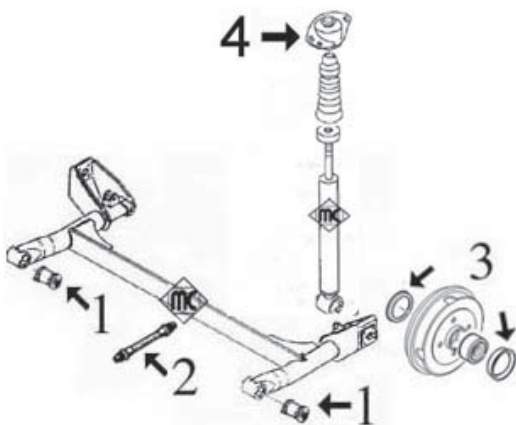

- 1- 4836 silentbloc puente trasero
- 2- 96077 latiguillo freno trasero (400 mm)
- 3- 4849 juego retén y tapa cubo rueda trasera
- 4- 4032 soporte amortiguador trasero

## FORD KA



**980**  
silentbloc anterior trapecio delantero  
r.o. no hay despiece



**981**  
silentbloc posterior trapecio delantero  
r.o. no hay despiece



**2631**  
goma barra estabilizadora  
r.o. 1035515



**2996**  
tope de goma suspensión delantera  
r.o. 6532212



**2998**  
capuchón amortiguador delantero  
r.o. 7379687



**4018**  
soporte amortiguador delantero  
r.o. 1013794



**4032**  
soporte amortiguador trasero  
r.o. 1023587

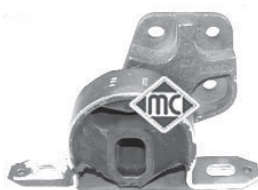

**4109**  
soporte motor izquierdo  
r.o. 1102507



**4161**  
soporte motor derecho  
r.o. 1032120



**4210**  
rodamiento soporte amortiguador delantero  
r.o. 1002513



**4216**  
soporte motor trasero  
r.o. 1136649



**4263**  
bieleta puntal barra estabilizadora  
r.o.

**¡Nuevo!**



**4836**  
silentbloc puente trasero  
r.o. 1016439

**¡Nuevo!**



**4849**  
juego retén y tapa cubo rueda trasera  
r.o. 1003554+1103509

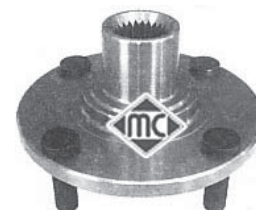

**90041**  
buje de rueda delantera  
r.o. 6517013



**96074**  
latiguillo freno delantero (530 mm)  
r.o. 1035269



**96077**  
latiguillo freno trasero (400 mm)  
r.o. 1042122

## FORD KA



**1197**  
fuelle cremallera asistida  
r.o. 1012814



**1534**  
fuelle cremallera manual  
r.o. 6935233



**2905**  
cruceta caña de dirección  
r.o. 7257202



**1373**  
kit fuelle transmisión lado rueda  
r.o. 1073807-1060629



**1079**  
kit fuelle transmisión lado cambio  
r.o.



**2024**  
arandela tapón de cárter con retén de goma, r.o.



**2714**  
soporte posterior tubo de escape  
r.o. 1025233



**2419**  
soporte catalizador  
r.o. 6831302

SILICONA



**669**  
tapón cárter de aceite (14 x 150)  
r.o. 6732529

SUSPENSION DELANTERA y SOPORTES DE MOTOR, MONDEO I y II 1993-2000:

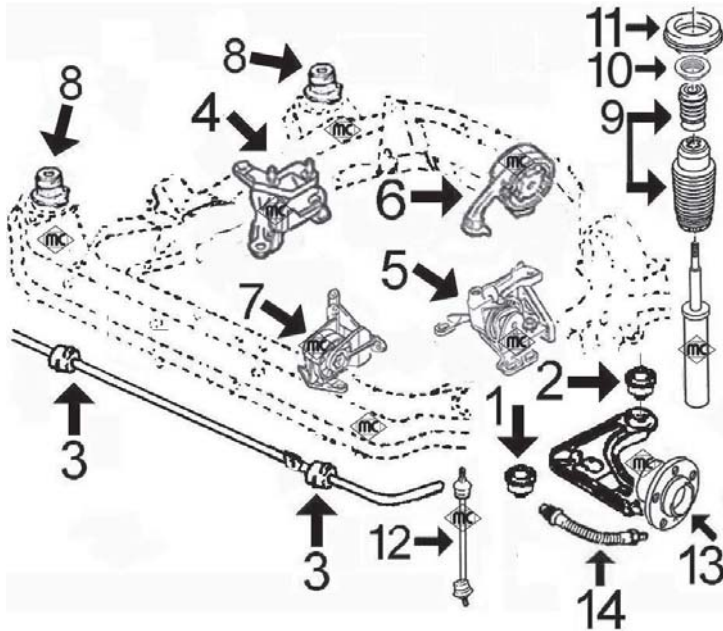

- 1- 2659 silentbloc anterior trapecio delantero
- 2- 2658 silentbloc posterior trapecio delantero hasta 8/'96
- 4015 silentbloc posterior trapecio delantero desde 8/'96
- 3- 4013 goma para barra estabilizadora de 18 mm
- 4- 4293 soporte motor derecho 1.8 Diesel
- 4696 soporte motor derecho 1.6-1.8-2.0
- 5- 4239 soporte cambio 1.6-1.8-2.0
- 4761 soporte cambio 1.8 Diesel
- 6- 4825 soporte motor trasero 1.6-1.8-2.0-1.8D
- 7- 4958 soporte motor delantero (antipar)
- 8- n/d juego silentblocs sub-chasis delantero
- 9- 4930 juego tope poliuretano y fuelle suspensión delt.
- 10- 4208 rodamiento soporte amortiguador
- 11- 2768 soporte amortiguador delantero
- 12- 4263 bieleta puntal barra estabilizadora
- 13- 90060 buje de rueda delantera
- 14- 96063 latiguillo freno delantero (425 mm)



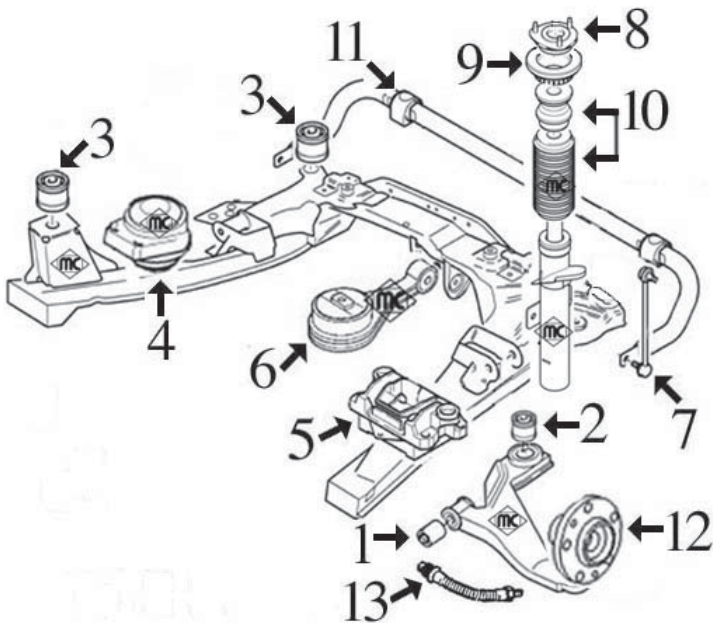













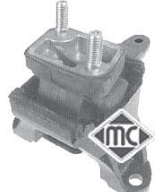

SUSPENSION DELANTERA y SOPORTES DE MOTOR, MONDEO III 2000-:





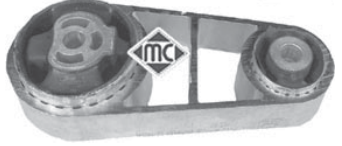

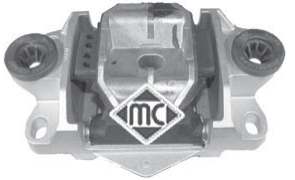
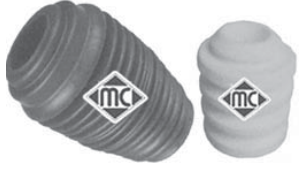









- 1- 4931 silentbloc anterior trapecio delantero
- 2- 4932 silentbloc posterior trapecio delantero
- 3- n/d silentbloc sub-chasis delantero (4 piezas por vehículo)
- 4- 4910 soporte motor derecho 1.8-2.0 gasolina
- 4757 soporte motor derecho 2.0 Diesel
- 5- 4911 soporte motor izquierdo
- 6- 4899 soporte motor trasero
- 7- 4900 bieleta puntal barra estabilizadora
- 8- 4935 soporte amortiguador delantero
- 9- n/d rodamiento soporte amortiguador
- 10- n/d juego tope poliuretano y fuelle suspensión delt.
- 11- 4934 goma barra estabilizadora hasta 8/'03
- n/d goma barra estabilizadora desde 8/'03
- 12- n/d buje de rueda delantera
- 13- 96066 latiguillo freno delantero (476 mm)

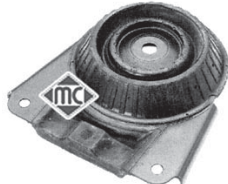



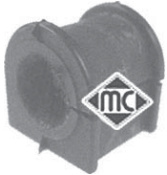

















## FORD MONDEO

 <p><b>2658</b> silentbloc posterior trapecio delantero I r.o. 6870549</p>	 <p><b>2659</b> silentbloc anterior trapecio delantero I-II r.o. 6790115</p>	 <p><b>2768</b> soporte amortiguador delantero I-II r.o. 6799585</p>
 <p><b>4013</b> goma barra estabilizadora delantera I-II r.o. 6714195</p>	 <p><b>4015</b> silentbloc posterior trapecio delantero II modelo '97, r.o. 1023058</p>	 <p><b>4208</b> rodamiento soporte amortiguador del T. I-II r.o. 1103725</p>
 <p><b>4263</b> bieleta puntal barra estab. delantera I-II r.o. 1130273-1661237</p>	 <p><b>4239</b> soporte motor izquierdo 1.6-1.8-2.0 I-II r.o. 6965937</p>	 <p><b>4293</b> soporte motor derecho 1.8 Diesel I-II r.o. 7139091</p>
<p><i>¡Nuevo!</i></p>  <p><b>4680</b> juego silentblocs sub-chasis trasero Mondeo-III, r.o. ---</p>	<p><i>¡Nuevo!</i></p>  <p><b>4696</b> soporte motor derecho 1.6-1.8-2.0 I-II r.o. 1053940</p>	<p><i>¡Nuevo!</i></p>  <p><b>4757</b> soporte motor derecho-III 2.0 Diesel r.o. 1332838-1220636</p>
<p><i>¡Nuevo!</i></p>  <p><b>4761</b> soporte cambio 1.8 Diesel r.o. 1078554-1064451</p>	<p><i>¡Nuevo!</i></p>  <p><b>4825</b> soporte motor trasero I-II r.o. 1024959-1097914-1097920</p>	<p><i>¡Nuevo!</i></p>  <p><b>4899</b> soporte motor trasero III r.o. 1351679-1152888</p>
<p><i>¡Nuevo!</i></p>  <p><b>4900</b> bieleta puntal barra estabilizadora delt. III r.o. 1127646</p>	<p><i>¡Nuevo!</i></p>  <p><b>4910</b> soporte motor derecho 1.8-2.0 III r.o. 1123542</p>	<p><i>¡Nuevo!</i></p>  <p><b>4911</b> soporte motor izquierdo III r.o. 1152896</p>
<p><i>¡Nuevo!</i></p>  <p><b>4930</b> juego tope poliuretano y fuelle susp delt. I-II r.o. 1023327+1023328</p>	<p><i>¡Nuevo!</i></p>  <p><b>4931</b> silentbloc anterior trapecio delantero III r.o.</p>	<p><i>¡Nuevo!</i></p>  <p><b>4932</b> silentbloc posterior trapecio delantero III r.o.</p>

## FORD MONDEO

<p><b>¡Nuevo!</b></p>  <p><b>4934</b> goma barra estabilizadora delantera III r.o. 1118695</p>	<p><b>¡Nuevo!</b></p>  <p><b>4935</b> soporte amortiguador delantero III r.o. 4386426</p>	<p><b>¡Nuevo!</b></p>  <p><b>4958</b> soporte motor delantero Mondeo-I/II (anti-par), r.o. 1097906-1097911</p>
 <p><b>90060</b> buje rueda delantera I-II r.o. 7346525</p>	 <p><b>96063</b> latiguillo freno delantero I-II (425 mm) r.o. 7067563</p>	<p><b>¡Nuevo!</b></p>  <p><b>96066</b> latiguillo freno delantero III (476 mm) r.o. 1212748</p>
 <p><b>4014</b> goma barra estabilizadora <b>trasera</b> I-II r.o. 7144204</p>	 <p><b>4016</b> soporte amortiguador <b>trasero</b> I-II r.o. 6838725</p>	 <p><b>4235</b> bieleta puntal barra estabilizadora <b>trasera</b> Mondeo-I ('93-'97), r.o. 7014210</p>
 <p><b>4236</b> bieleta puntal barra estabilizadora <b>trasera</b> Mondeo-II ('97-'00), r.o. 1054209</p>	<p><b>¡Nuevo!</b></p>  <p><b>4901</b> bieleta puntal barra estabilizadora <b>trasera</b> Mondeo-III, r.o. 1127648</p>	<p><b>¡Nuevo!</b></p>  <p><b>4936</b> soporte amortiguador <b>trasero</b> Mondeo-III r.o. 1303625</p>
<p><b>¡Nuevo!</b></p>  <p><b>4937</b> goma barra estabiliz. <b>trasera</b> Mondeo-III r.o. 1118695</p>	 <p><b>96068</b> latiguillo freno trasero I-II (305 mm) racores hembra-hembra, r.o. 6758585</p>	<p><b>¡Nuevo!</b></p>  <p><b>96061</b> latiguillo freno trasero I-II (315 mm) racores hembra-macho, r.o. 1023692</p>
<p><b>¡Nuevo!</b></p>  <p><b>96067</b> latiguillo freno trasero III r.o. 1121635</p>		

## FORD MONDEO

 <p><b>2818</b> serreta pedal embrague r.o. 6706221</p>	<p><i>¡Nuevo!</i></p>  <p><b>3704</b> tapón llenado aceite motor 1.8 Diesel '96-'00 r.o. 1131866</p>	<p><i>¡Nuevo!</i></p>  <p><b>3705</b> tapón llenado aceite motor 1.6-1.8-2.0D r.o. 1122713</p>
 <p><b>8138</b> mgtto de bomba de agua 1.8 Diesel r.o.</p>	 <p><b>3061</b> boquilla en culata (codo aluminio) 1.8 D r.o. 1592026</p>	 <p><b>3126</b> boquilla en culata (recta, aluminio) 1.8 D r.o.</p>
 <p><b>3066</b> tubo de agua metálico 1.8 Diesel r.o. 6180946</p>	 <p><b>3089</b> tubo de agua metálico 1.6-1.8 Zetec r.o. 1057173</p>	 <p><b>3562</b> tapa de termostato 1.6-1.8 Zetec (gasolina) r.o. 6756229</p>
 <p><b>3606</b> tapa de termostato 1.8 Diesel r.o. 6189058</p>	<p><i>¡Nuevo!</i></p>  <p><b>4845</b> caja de termostato 1.8 Diesel r.o. 1079905</p>	<p><i>¡Nuevo!</i></p>  <p><b>3706</b> caja completa con termostato 2.0 Diesel r.o.</p>
 <p><b>3561</b> tapón botella de expansión r.o. 7267962</p>	<p><i>¡Nuevo!</i></p>  <p><b>3149</b> boquilla en culata 1.8 Diesel r.o. 6720378</p>	
<p><i>¡Nuevo!</i></p>  <p><b>4820</b> polea de cigueñal 1.8 Diesel r.o. 6186296</p>	<p><i>¡Nuevo!</i></p>  <p><b>4815</b> polea de cigueñal 1.8 Diesel r.o. 6811202</p>	<p><i>¡Nuevo!</i></p>  <p><b>4819</b> polea de cigueñal 1.8 Diesel r.o. 6767897</p>
<p><i>¡Nuevo!</i></p>  <p><b>4816</b> polea de cigueñal 2.0 Diesel r.o. 1351731</p>	<p><i>¡Nuevo!</i></p>  <p><b>4817</b> polea de cigueñal 1.8-2.0 Zetec-E gasolina r.o. 1135052</p>	

## FORD MONDEO



**1995**  
fuelle cremallera asistida MONDEO  
r.o. 6772173



**1993**  
kit rep. transmisión l/rueda Mondeo I-II  
(homocinética de Ø 80 mm), r.o. 6757617



**1994**  
kit rep. transmisión l/rueda Mondeo I-II  
(homocinética de Ø 87 mm), r.o. 6757618



**1520**  
kit fuelle transmisión lado rueda Mondeo-III  
r.o.



**1227**  
kit fuelle transmisión l/ cambio Mondeo-III  
r.o.



**232**  
soporte tubo de escape  
r.o. 6120254



**2756**                      **SILICONA**  
soporte tubo de escape  
r.o. 6679949



**2419**                      **SILICONA**  
soporte tubo de escape  
r.o. 6831302



**4714**  
tapón de cárter motor 2.5V6 gasolina  
(M12x175), r.o. 7123346



**669**  
tapón de cárter (M14x150)  
r.o. 1454117



**2024**  
arandela tapón cárter con retén de goma  
r.o.



## FORD TAUNUS - SIERRA - SCORPIO



**509** Ø ext. 126 mm  
flector de transmisión SIERRA-SCORPIO  
r.o.

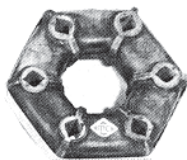

**189** Ø ext. 145 mm  
flector de transmisión SIERRA-SCORPIO  
r.o.

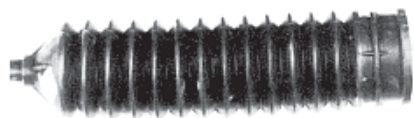

**1527**  
fuente cremallera manual y asistida SIERRA-SCORPIO



**1624**  
kit rep. transmisión trasera SIERRA-SCORPIO



**519**  
serreta pedal embrague SIERRA  
r.o.6180329



**2649**  
silentbloc brazo delantero SIERRA  
r.o.



**931**  
soporte motor SIERRA  
r.o. 6532935

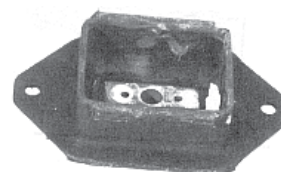

**932**  
soporte cambio SIERRA  
r.o.6155997



**2419** SILICONA  
soporte tubo de escape  
r.o. 6831302



**232** SILICONA  
soporte tubo de escape SIERRA-SCORPIO  
r.o. 6120254



**2756** SILICONA  
soporte tubo escape SIERRA-SCORPIO  
r.o.6679949

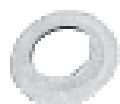

**2020**  
arandela tapón de cárter nylon  
r.o.



**669**  
tapón de cárter 14x15  
r.o. 1454117



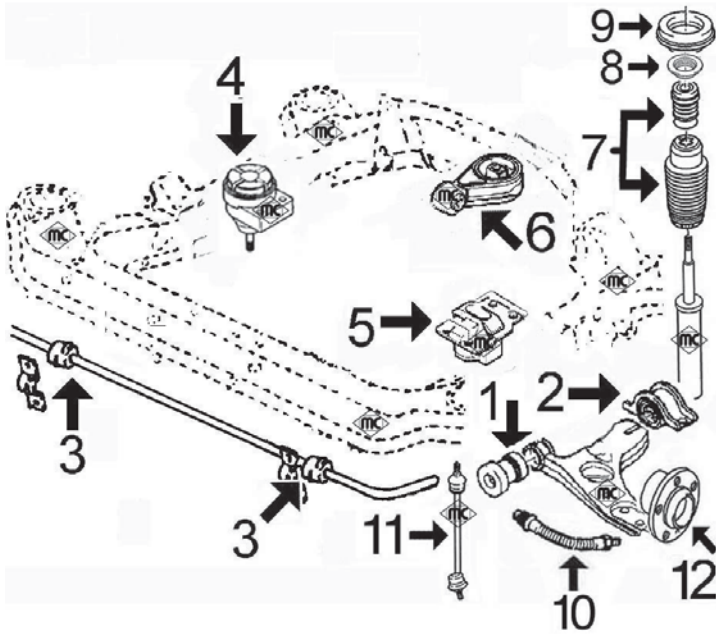

**2024**  
arandela tapón cárter con retén de goma  
r.o.

SUSPENSION DELANTERA y SOPORTES DE MOTOR





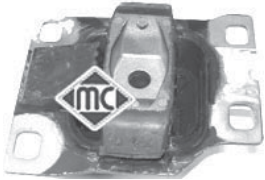

















- 1- 4020 silentbloc anterior trapecio delantero
- 2- 4021 silentbloc posterior trapecio delantero
- 3- 4213 goma barra estabilizadora
- 4- 4107 soporte motor derecho 1.8 gasolina Zetec-E
- 4108 soporte motor derecho 1.8 Diesel TdDi
- 5- 4104 soporte motor izquierdo
- 6- 4106 soporte motor trasero
- 7- 4876 juego tope poliuretano y capuchón amortiguador
- 8- 4207 rodamiento soporte amortiguador
- 9- 4111 soporte amortiguador delantero
- 10- n/d latiguillo freno delantero
- 11- 4160 bieleta puntal barra estabilizadora
- 12- 90041 buje de rueda delantera

## FORD TRANSIT CONNECT

 <p><b>4020</b> silentbloc anterior trapecio delantero r.o. 1061570</p>	 <p><b>4021</b> silentbloc posterior trapecio delantero r.o. no hay despiece (va con trapecio)</p>	 <p><b>4104</b> soporte motor izquierdo r.o. 1133019</p>
 <p><b>4106</b> soporte motor trasero r.o. 1094591</p>	 <p><b>4107</b> soporte motor derecho 1.8-Zetec E r.o. 1112025</p>	
 <p><b>4108</b> soporte motor derecho 1.8 Diesel r.o. 1142702</p>	 <p><b>4111</b> soporte amortiguador delantero r.o. 1087177</p>	 <p><b>4160</b> bieleta puntal barra estabilizadora r.o. 1135077</p>
 <p><b>4207</b> rodamiento soporte amortiguador delantero r.o. 1115132</p>	 <p><b>4213</b> goma barra estabilizadora delantera r.o. 1073217</p>	 <p><b>4876</b> juego tope poliuretano y capuchón amortg. r.o.</p>
 <p><b>90041</b> bujes rueda delantera r.o. 3903036</p>	 <p><b>90515</b> bujes rueda trasera con rodamiento r.o.</p>	

## FORD TRANSIT CONNECT

<p><b>¡Nuevo!</b></p>  <p><b>4817</b> polea cigüeñal 1.8 Zetec-E gasolina r.o. 1135052</p>	<p><b>¡Nuevo!</b></p>  <p><b>4818</b> polea cigüeñal 1.8 Diesel de 75CV r.o. 1100051</p>	<p><b>¡Nuevo!</b></p>  <p><b>4639</b> polea cigüeñal 1.8 Diesel de 90CV r.o. 1151392</p>
<p><b>¡Nuevo!</b></p>  <p><b>3704</b> tapón llenado aceite motor 1.8 Diesel r.o.</p>	<p><b>¡Nuevo!</b></p>  <p><b>3705</b> tapón llenado aceite motor 1.8 Zetec-E r.o.</p>	<p><b>¡Nuevo!</b></p>  <p><b>3744</b> botella de expansión r.o. 1104120</p>
<p><b>¡Nuevo!</b></p>  <p><b>3191</b> tubo de agua metálico 1.8 Diesel r.o.</p>	<p><b>¡Nuevo!</b></p>  <p><b>9131</b> juego mgts de tubo metálico a caja 1.8D r.o.</p>	<p><b>¡Nuevo!</b></p>  <p><b>3713</b> caja completa con tapa y termostato 1.8D r.o. 1198060</p>
<p><b>¡Nuevo!</b></p>  <p><b>3192</b> tubo metálico con mgto de calefactor 1.8D r.o.</p>	<p><b>¡Nuevo!</b></p>  <p><b>3561</b> tapón botella de expansión r.o. 7267962</p>	<p><b>¡Nuevo!</b></p>  <p><b>3562</b> tapa de termostato 1.8 Zetec-E gasolina r.o. 1052405</p>
<p><b>¡Nuevo!</b></p>  <p><b>4752</b> tensor correa alternador con polea de rueda libre, 1.8 Diesel de 100 y 115CV, r.o. 1151207</p>	<p><b>¡Nuevo!</b></p>  <p><b>2903</b> tapón cárter de aceite con junta de goma r.o. 1013938</p>	<p><b>¡Nuevo!</b></p>  <p><b>2021</b> arandela tapón cárter de aceite r.o. 1005593</p>
<p><b>¡Nuevo!</b></p>  <p><b>1351</b> fuelle cremallera dirección r.o. 1085517</p>	<p><b>¡Nuevo!</b></p>  <p><b>1298</b> kit rep transmisión l/rueda r.o. 1061864</p>	<p><b>¡Nuevo!</b></p>  <p><b>1049</b> kit rep transmisión l/cambio r.o.</p>
<p><b>¡Nuevo!</b></p>  <p><b>4168</b> soporte tubo de escape r.o. 1061967</p>	<p><b>¡Nuevo!</b></p>  <p><b>4270</b> soporte tubo de escape r.o. 1016405</p>	<p><b>¡Nuevo!</b></p>  <p><b>418</b> cubrepedal freno y embrague r.o.</p>



**CANALIZACIONES DE AGUA:**

**TRANSIT 2.5 Diesel 1986-1995:**

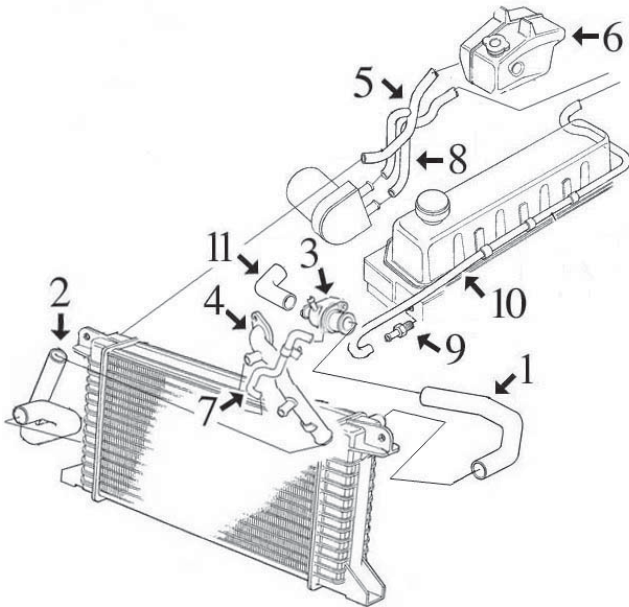

- 1- 7982 mgto superior radiador
- 2- 7983 mgto inferior radiador
- 3- 3712 caja completa con tapa y termostato
- 4- 3190 tubo de agua metálico
- 5- 7984 mgto de radiador a botella hasta '92
- 9136 mgto de radiador a botella desde '92 a '95
- 6- 3608 tapón botella de expansión
- n/d botella de expansión
- 7- 9115 mgto de tubo metálico a caja de termostato
- 8- 9137 mgto de intercambiador a calefactor
- 9- 3126 boquilla en culata (aluminio)
- 10- 9138 mgto de calefactor a culata
- 11- 9139 mgto de termostato a bomba

**TRANSIT 2.5 Diesel y TurboD 1995-1999:**

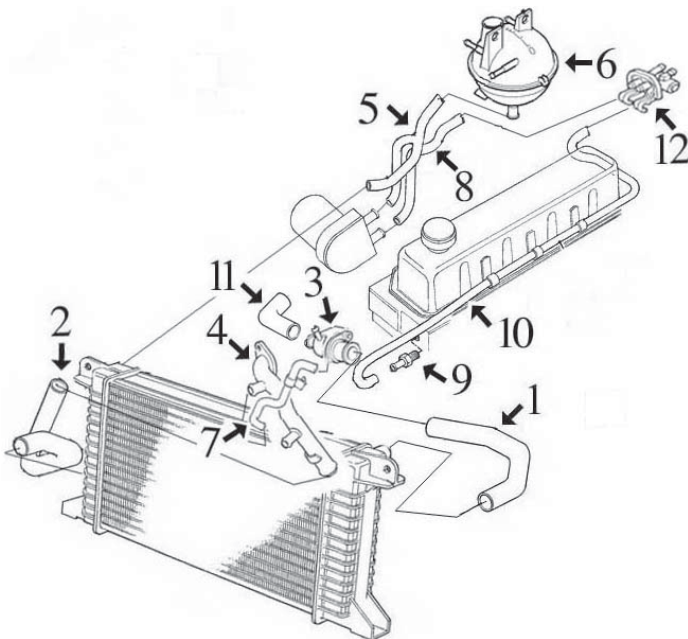

- 1- 9118 mgto superior radiador 2.5D sin aire acond.
- 9119 mgto superior radiador 2.5D aire acondicionado
- 9120 mgto superior radiador 2.5 TurboD
- 2- 9121 mgto inferior radiador
- 3- 3712 caja completa con tapa y termostato
- 4- 3190 tubo de agua metálico
- 5- 9122 mgto de radiador a botella 2.5 D
- 9116 mgto de radiador a botella 2.5 TurboD
- 6- 3695 botella de expansión
- 3701 tapón botella de expansión
- 7- 9115 mgto de tubo metálico a caja de termostato
- 8- 9117 mgto de intercambiador a calefactor 2.5 TurboD con aire acondicionado
- 9- 3126 boquilla en culata (aluminio)
- 10- n/d mgto de calefactor a culata
- 11- 9139 mgto de termostato a bomba
- 12- 4822 válvula de calefacción

## FORD TRANSIT 1986-1999



**7982**  
mgto superior radiador 2.5D hasta '95  
r.o. 6152859-6777718



**7983**  
mgto inferior radiador 2.5D hasta '95  
r.o. 1631363



**7984**  
mgto de calefactor a botella 2.5D hasta '95  
r.o. 6148673

**¡Nuevo!**



**9115**  
mgto de tubo metálico a caja de termostato  
r.o.

**¡Nuevo!**



**9116**  
mgto de radiador a botella 2.5TD desde '95  
r.o.

**¡Nuevo!**



**9117**  
mgto de intercambiador a calefactor 2.5TD  
r.o.

**¡Nuevo!**



**9118**  
mgto sup radiador 2.5D sin aire acond.  
r.o.

**¡Nuevo!**



**9119**  
mgto sup radiador 2.5D con aire acondic.  
r.o.

**¡Nuevo!**



**9120**  
mgto sup radiador 2.5TurboD  
r.o.

**¡Nuevo!**



**9121**  
mgto inferior radiador 2.5D-2.5TD desde '95  
r.o.

**¡Nuevo!**

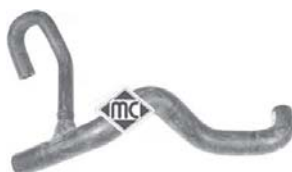

**9122**  
mgto de radiador a botella 2.5D desde '95  
r.o.

**¡Nuevo!**



**9136**  
mgto de radiador a botella 2.5D de '92 a '95  
r.o.

**¡Nuevo!**



**9137**  
mgto de intercambiador a calefactor 2.5D  
hasta '95, r.o.

**¡Nuevo!**



**9138**  
mgto de calefactor a culata 2.5D hasta '95  
r.o.

**¡Nuevo!**



**9139**  
mgto de termostato a bomba 2.5D-TD  
r.o.



**3126**  
boquilla en culata (aluminio) 2.5D-TD  
r.o. 6148087

**¡Nuevo!**



**3190**  
tubo de agua metálico 2.5D-TD  
r.o.

**¡Nuevo!**



**3608**  
tapón botella de expansión hasta '95  
r.o.

**¡Nuevo!**



**3695**  
botella de expansión desde '95  
r.o. 7166663-7166664

**¡Nuevo!**



**3701**  
tapón botella de expansión desde '95  
r.o. 1029727

**¡Nuevo!**



**3712**  
caja de termostato completa 2.5D-TD  
r.o.

**¡Nuevo!**



**4822**

válvula de calefacción desde '95  
r.o. 1085638-1047752

**SUSPENSION DELANTERA y SOPORTES DE MOTOR hasta '00:**

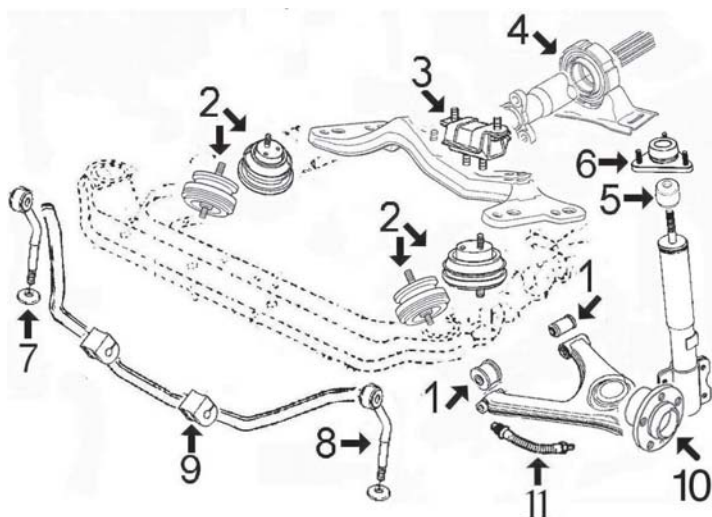

- 1- 2807 juego silentbloks trapecio delantero
- 2- 2790 soporte motor derecho e izquierdo hasta '95  
4023 soporte motor derecho (hidráulico) desde '95  
4410 soporte motor izquierdo (hidráulico) desde '95
- 3- 2798 soporte cambio
- 4- 2802 soporte transmisión con rodamiento Ø 30 mm  
4025 soporte transmisión con rodamiento Ø 45 mm
- 5- 4022 tope de goma amortiguador delantero
- 6- 2805 soporte amortiguador delantero
- 7- 4281 bieleta derecha puntal barra estabilizadora
- 8- 4240 bieleta izquierda puntal barra estabilizadora
- 9- 2799 goma soporte barra estabilizadora
- 10- 90098 buje rueda delantera (para modelos sin rueda trasera gemela)
- 11- 96184 latiguillo freno delantero izquierdo  
96185 latiguillo freno delantero derecho

**SUSPENSION TRASERA hasta '00:**

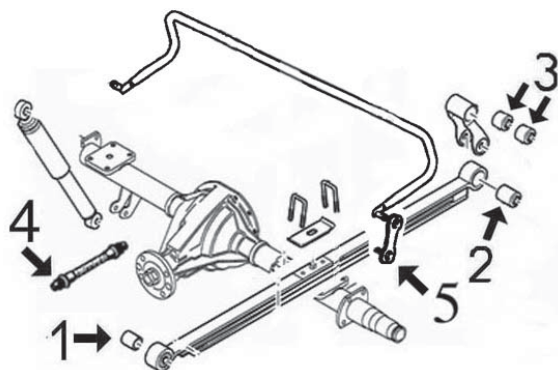

- 1- 2800 silentbloc anterior ballesta trasera
- 2- 2801 silentbloc posterior inferior ballesta trasera
- 3- 2803 silentbloc posterior superior ballesta trasera
- 4- 96186 latiguillo freno trasero (montaje separados verticalmente)  
96071 atiguillo freno trasero (montaje separados diagonalmente)
- 5- n/d bieleta puntal barra estabilizadora

## FORD TRANSIT 1986-1999



**2790**  
soporte motor hasta '95  
r.o. 7055286



**2798**  
soporte cambio  
r.o. 6177036-1045715



**2799**  
goma soporte barra estabilizadora  
r.o. 6521811



**2802**  
soporte transm. con rodamiento Ø 30 mm  
r.o. 4104708

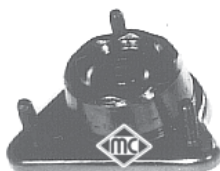

**2805**  
soporte amortiguador delantero  
r.o. 6763456



**2807**  
juego silentblocs trapecio delantero  
r.o. 6608818+6517356



**4022**  
tope de goma amortiguador delantero  
r.o. 6142480

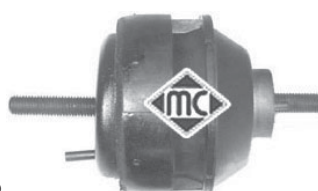

**4023**  
soporte motor **derecho** d/'95 (hidráulico)  
(marcaroja) r.o. 7354179



**4025**  
soporte transm. con rodamiento Ø 45 mm  
r.o. 6649122

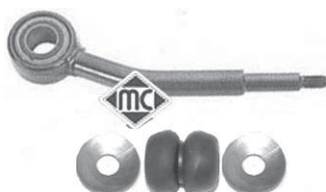

**4240**  
bieleta **izquierda** puntal barra estabilizadora  
delantera, r.o. 6150971+1481465+1631619



**4281**  
bieleta **derecha** puntal barra estabilizadora  
delantera, r.o. 6150970+1481465+1631619

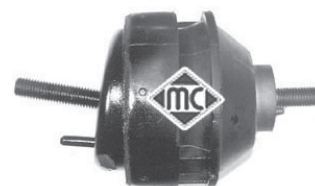

**4410**  
soporte motor **izquierdo** d/'95 (hidráulico)  
(marca verde) r.o. 7354180

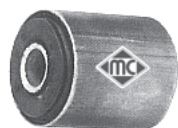

**2800** (18x57x69x61)  
silentbloc anterior ballesta trasera  
r.o. 7238510

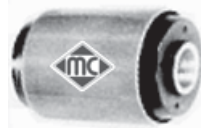

**2801** (16x50.5x82x61)  
silentbloc posterior inferior ballesta trasera  
r.o. 6191746



**2803** (cónico)  
silentbloc posterior superior ballesta tras.  
(gemela), r.o. 1575214



**¡Nuevo!**



**90098**  
buje rueda delantera para modelos con  
rueda trasera simple, r.o. 1077708



**96184**  
latiguillo freno delantero izquierdo  
r.o. 6158425-6577424



**96185**  
latiguillo freno delantero derecho  
r.o. 6158424-6577423



**96186**  
latiguillo freno trasero, separados vertical-  
mente, r.o. 6577425







**¡Nuevo!**



**96071**  
latiguillo freno trasero, separados diag-  
nalmente, r.o. 6577426

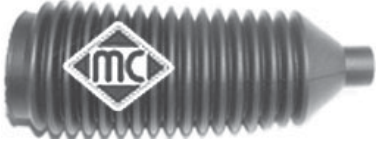

## FORD TRANSIT 1986-1999

<p><b>¡Nuevo!</b></p>  <p><b>4821</b> polea cigueñal 2.5 D con aire acondicionado r.o. 1050620</p>	<p><b>¡Nuevo!</b></p>  <p><b>4837</b> polea cigueñal 2.5D sin aire acondicionado r.o. 1050619</p>	 <p><b>669</b> tapón cárter 14 x 150 r.o. 6732529</p>
 <p><b>1196</b> kit fuelle cremallera asistida r.o. 6160070-1045715</p>	 <p><b>793</b> serreta pedal embrague completa hasta '95 r.o. 6183028</p>	
 <p><b>2806</b> cubrepedal freno y embrague r.o. 1631037</p>	 <p><b>093</b> soporte tubo de escape hasta '95 r.o. 1591419</p>	 <p><b>2757</b> soporte tubo de escape desde '95 r.o. 7092700</p>

SUSPENSION DELANTERA y SOPORTES DE MOTOR:

2.0 Diesel "Duratorq" motor transversal, tracción delantera:

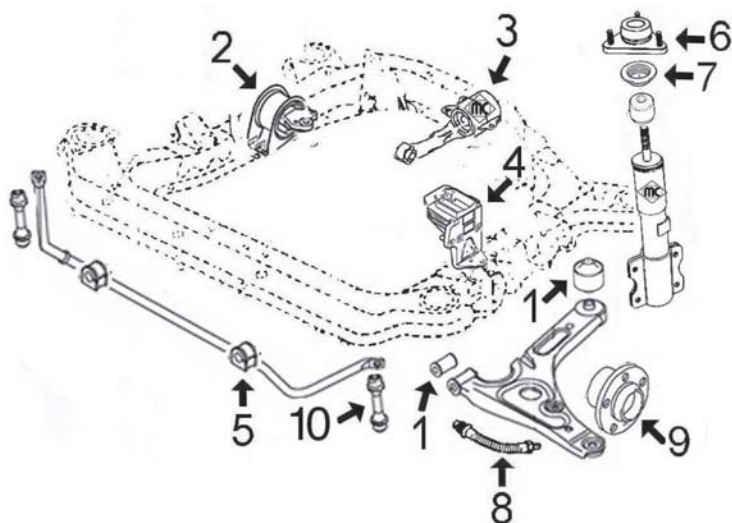

- 1- 4813 juego silentblocs trapecio delantero
- 2- 4811 soporte motor derecho
- 3- 4812 soporte motor trasero
- 4- 4810 soporte motor izquierdo
- 5- 4834 goma barra estabilizadora
- 6- 4833 soporte amortiguador delantero
- 7- 4208 rodamiento soporte amortiguador delantero
- 8- n/d latiguillo freno delantero
- 9- n/d buje rueda delantera
- 10- 4886 bieleta puntal barra estabilizadora

2.4 Diesel "Duratorq" motor longitudinal, propulsión trasera:

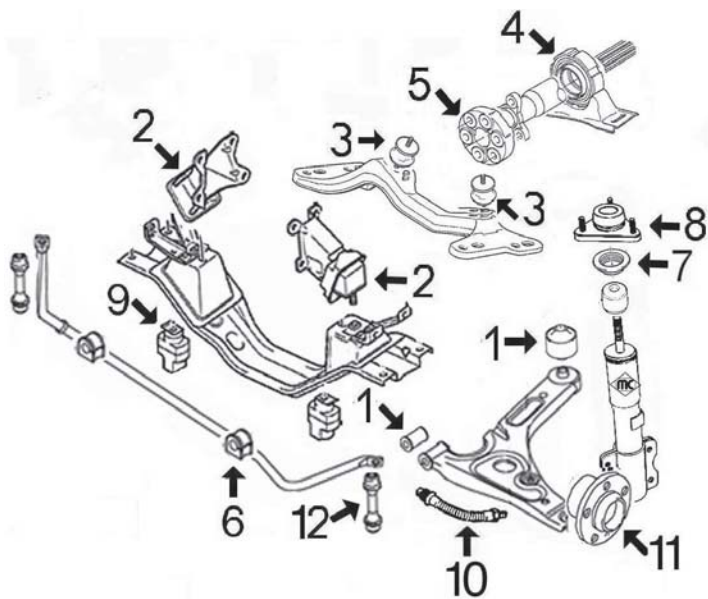





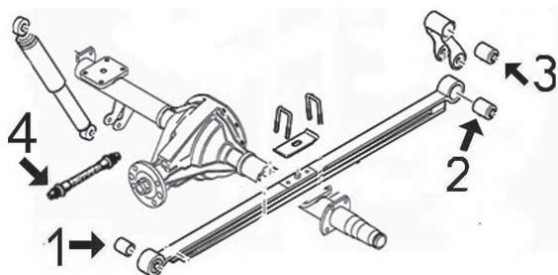





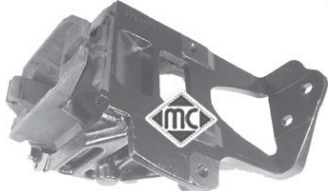

- 1- 4813 juego silentblocs trapecio delantero
- 2- 4808 soporte motor derecho e izquierdo
- 3- 4809 soporte motor trasero
- 4- 2802 soporte barra transmisión
- 5- 4883 flector de transmisión
- 6- 4834 goma barra estabilizadora
- 7- 4208 rodamiento soporte amortiguador delantero
- 8- 4833 soporte amortiguador delantero
- 9- n/d soporte travesía delantera
- 10- n/d latiguillo freno delantero
- 11- n/d buje rueda delantera
- 12- 4886 bieleta puntal barra estabilizadora

SUSPENSION TRASERA:

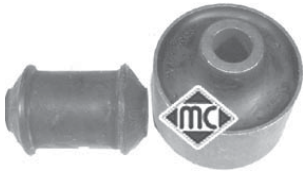
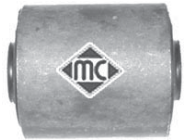

- 1- 4831 silentbloc anterior ballesta trasera
- 2- 4832 silentbloc posterior inferior ballesta trasera
- 3- n/d silentbloc posterior superior ballesta trasera
- 4- n/d latiguillo freno trasero

## FORD TRANSIT 2000-

 <p><b>2802</b> soporte árbol de transmisión 2.4D r.o.4104708</p>	 <p><b>4208</b> rodamiento soporte amortiguador delantero r.o.1103725</p>	 <p><b>4808</b> soporte motor 2.4D (motor longitudinal) r.o.</p>
 <p><b>4809</b> soporte cambio 2.4D (motor longitudinal) r.o.4059109</p>	 <p><b>4810</b> soporte motor izquierdo 2.0D (motor transversal), r.o. 4363743</p>	 <p><b>4811</b> soporte motor derecho 2.0D (motor transversal), r.o.</p>
 <p><b>4812</b> soporte motor trasero 2.0D r.o.</p>	 <p><b>4813</b> juego silentblocs trapecio delantero r.o.4042024+4131788</p>	 <p><b>4831</b> silentbloc anterior ballesta trasera r.o.4055743</p>
 <p><b>4832</b> silentbloc posterior ballesta trasera r.o. 4041521</p>	 <p><b>4833</b> soporte amortiguador delantero r.o.4094280</p>	 <p><b>4834</b> goma barra estabilizadora delantera r.o.4041489</p>
 <p><b>4883</b> flector de transmisión 2.4D (propulsión tras.) r.o.4393343</p>	 <p><b>4886</b> bieleta puntal barra estabiliz. delantera r.o.3736028</p>	

## FORD TRANSIT 2000-

<p><b>¡Nuevo!</b></p>  <p><b>3702</b> botella de expansión r.o. 4042232</p>	<p><b>¡Nuevo!</b></p>  <p><b>3701</b> tapón botella de expansión r.o. 1029727</p>	<p><b>¡Nuevo!</b></p>  <p><b>3706</b> caja de termostato completa 2.0 Diesel (incluye termostato), r.o. 1120640</p>
<p><b>¡Nuevo!</b></p>  <p><b>4814</b> polea cigueñal 2.0 Diesel 75/85PS r.o. 1329206</p>	<p><b>¡Nuevo!</b></p>  <p><b>4816</b> polea cigueñal 2.0 Diesel 100PS r.o. 1351731</p>	<p><b>¡Nuevo!</b></p>  <p><b>4839</b> polea cigueñal 2.4 Diesel r.o. 1329202</p>
<p><b>¡Nuevo!</b></p>  <p><b>1137</b> fuelle derecho cremallera dirección r.o. 4059922</p>	<p><b>¡Nuevo!</b></p>  <p><b>1138</b> fuelle izquierdo cremallera dirección r.o. 4059921</p>	 <p><b>1520</b> kit fuelle transmisión lado rueda 2.0D (motor transversal) r.o.</p>
<p><b>¡Nuevo!</b></p>  <p><b>1227</b> kit fuelle transmisión lado cambio 2.0D (motor transversal) r.o.</p>	<p><b>¡Nuevo!</b></p>  <p><b>4840</b> soporte tubo de escape r.o. 4042064</p>	 <p><b>2903</b> tapón cárter de aceite con junta r.o. 1013938</p>



## HYUNDAI - LADA NIVA



**1216**  
kit rep. transmisión l/rueda boca de 84 mm  
HYUNDAI,r.o.



**1959**  
kit rep. transmisión l/rueda boca de 76 mm  
HYUNDAI,r.o.

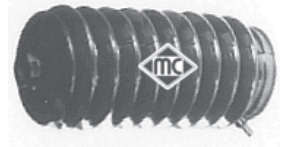

**1347**  
fuelle cremallera asistida  
HYUNDAI,r.o.



**2726**  
soporte tubo de escape HYUNDAI  
r.o.28658-22000-28658-34050



**2727**  
soporte tubo de escape HYUNDAI  
r.o.28658-24000



**3609**  
tapón de radiador 1.10 bar HYUNDAI  
r.o.



**4367**  
tapón cárter de aceite M-12x150 HYUNDAI  
r.o.



**2052**  
arandela cobre para tapón cárter Ø 12 mm  
r.o.



**7799**  
mgto superior radiador LADA NIVA  
r.o.2121-1303025



**7809**  
mgto inferior radiador LADA NIVA  
r.o.2121-1303010

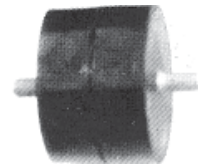

**203**  
soporte de motor derecho e izquierdo  
LADANIVA,r.o.2121-1002010

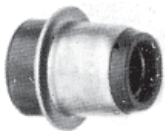

**143**  
silentbloc trapecio superior LADA NIVA  
r.o.2101-2904040-85

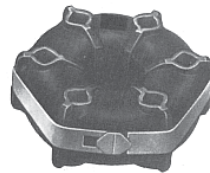

**220**  
flector de transmisión LADA NIVA  
r.o.2101-2202120-23

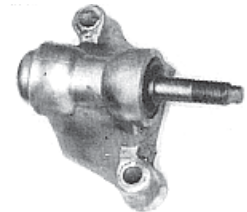

**301**  
caja de reenvío con rodamientos  
LADANIVA,r.o.2121-3414080



**3607**  
tapón radiador 0,7 bar LADA NIVA  
r.o.

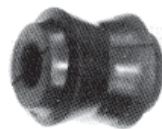

**129**  
silentbloc de tirantes longitudinales trase-  
ros cortos LADA NIVA, r.o.

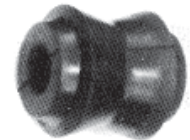

**163**  
silentbloc de tirantes longitudinales trase-  
ros largos y de barra transversal



**1852**  
kit rep. transmisión l/rueda LADA NIVA  
r.o.2121-2215030



**1613**  
kit rep. transmisión l/ cambio LADA NIVA  
r.o.2121-2215068



**156**  
soporte tubo de escape LADA NIVA  
r.o.2101-1203072

## CANALIZACIONES DE AGUA, Y-10 1.0/1.1 motor Fire

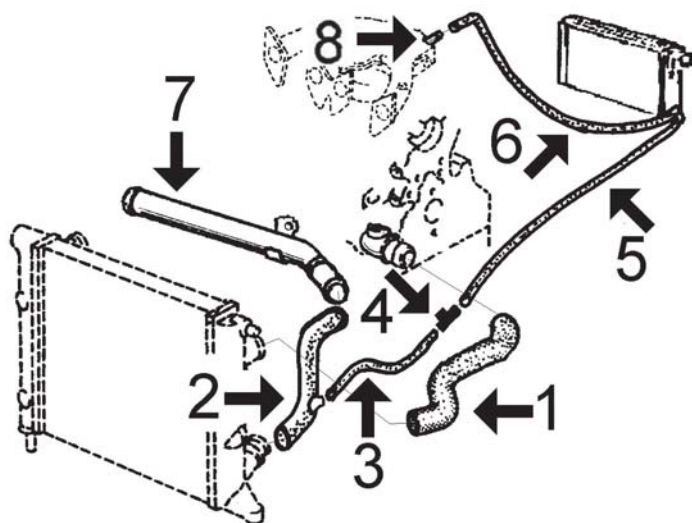

- 1- n/d mgto superior de radiador hasta '93  
8459 mgto superior radiador desde '93
- 2- n/d mgto inferior de radiador hasta '93  
8460 mgto inferior radiador desde '93
- 3- 5828 mgto de mgto inferior a purgador. Cortar de mgto ref. 5828 (Ø 15x22), longitud 350 mm
- 4- 971 purgador circuito de agua
- 5- 5828 mgto de purgador a calefactor
- 6- 7540 mgto de calefactor a colector de admisión
- 7- 3038 tubo metálico con junta tórica hasta '93  
3100 tubo metálico con junta tórica desde '93
- 8- 3128 boquilla metálica en colector
  
- 0132 mgto desvaporizador: Cortar de tubo referencia MC-0132, recto, Ø 20x28 mm, longitud 175 mm, de tapa balancines a filtro de aire



**3128**  
boquilla metálica en colector  
r.o. 7747183



**3740**  
tapón botella expansión 1.0 bar  
r.o. 46402983



**5828**  
mgto de calefactor a mgto inf. radiador  
r.o. 5994070-5989801



**7540**  
mgto de calefactor a colector de admisión  
r.o. 5994069



**3038**  
tubo de agua metálico con junta tórica hasta '93, r.o. 7545122



**3100**  
tubo de agua metálico desde '93  
r.o. 46419454

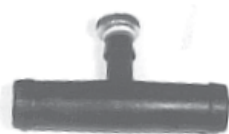

**971**  
purgador circuito de agua  
r.o.



**8459**  
mgto superior radiador desde '93  
r.o. 7718664



**8460**  
mgto inferior radiador desde '93  
r.o. 7797503

SUSPENSION DELANTERA y SOPORTES DE MOTOR, Y-10 1.0 / 1.1 motor Fire

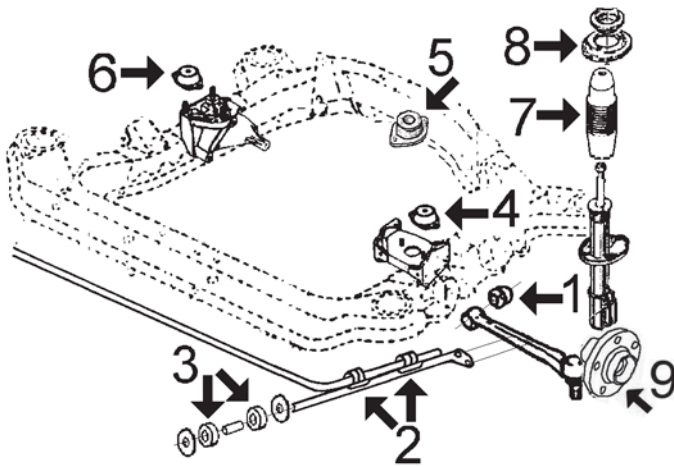

- 1- 459 silentbloc extremo brazo de suspensión
- 2- 2446 goma barra estabilizadora
- 3- 464 goma puntal tirante brazo delantero
- 4- n/d soporte de motor izquierdo
- 5- 2332 soporte de motor trasero
- 6- n/d soporte de motor derecho
- 7- 715 capuchón amortiguador delantero
- 8- n/d soporte superior amortiguador delantero
- 9- 90009 buje rueda delantera

n/d no disponible

 <p><b>459</b> silentbloc extremo brazo delantero r.o. 7548992</p>	 <p><b>464</b> goma puntal tirante brazo delantero r.o. 4448132</p>	 <p><b>715</b> capuchón amortiguador delantero r.o. 5978771</p>
 <p><b>2446</b> goma barra estabilizadora Ø 15 mm r.o. 7548992</p>	 <p><b>022</b> goma amortiguador trasero r.o. 0814677</p>	 <p><b>2332</b> soporte de motor trasero r.o. 7544643</p>
 <p><b>90009</b> buje rueda delantera r.o. 4900918</p>	 <p><b>4268</b> horquilla embrague r.o. 7617578</p>	 <p><b>245</b> goma varilla nivel aceite r.o. 4102056</p>
 <p><b>478</b> juego casquillos palancas de cambio r.o.</p>	 <p><b>257</b> fuelle derecho cremallera dirección r.o. 4371156</p>	 <p><b>258</b> fuelle izquierdo cremallera dirección r.o. 4371155</p>

## LANCIA Y10 - LAND ROVER



**2742**  
tapón llenado aceite  
LANCIA r.o. 7713649



**2789**  
tapón bloque motor Ø 50 mm  
LANCIA r.o. 7579570



**4893**  
tapón bloque motor Ø 51 mm  
LANCIA r.o. 91600682



**1578**  
kit reparación transmisión lado rueda  
LANCIA r.o. 7642776



**1583**  
kit rep. transmisión izquierda l/cambio  
completo con rodamiento, LANCIA



**583**  
fuelle transmisión izquierda lado cambio  
LANCIA r.o. 7625541



**1599**  
kit rep. transmisión derecha lado cambio  
completo con rodamiento, LANCIA



**349**  
fuelle transmisión derecha lado cambio  
LANCIA r.o. 7921245

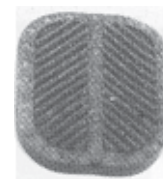

**411**  
cubrepedal freno y embrague LANCIA  
r.o. 4144275



**243**  
soporte tubo de escape LANCIA  
r.o. 4393777



**094**  
soporte silenciador LANCIA  
r.o. 7600807



**2920**  
kit reparación brazo suspensión trasero  
LANCIA r.o. no hay despiece

**¡Nuevo!**



**3750**  
cubierta tapa distribución (una pieza)  
LANCIA Y10, r.o. 7656118

**¡Nuevo!**



**3751**  
cubierta tapa distribución (dos piezas)  
LANCIA Y10, r.o. 7752155-7752153

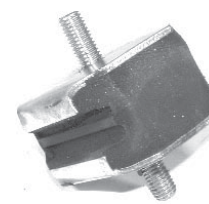

**406**  
soporte cambio (rosca M-10)  
LANDROVER, r.o. 594583

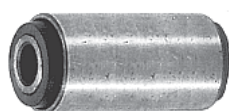

**146**  
silentbloc ballesta (14x30x70x63.5)  
LANDROVER, r.o. 233573

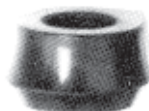

**024**  
goma amortiguador (Ø 19x36, altura 22)  
LANDROVER, r.o. 243057



**209**  
soporte tubo de escape  
LANDROVER, r.o. 244316

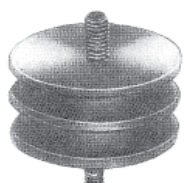

**404**  
soporte de motor Ø 63 mm (rosca M-10)  
LANDROVER, r.o. 277513

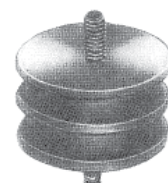

**405**  
soporte de motor Ø 57 mm (rosca M-10)  
LANDROVER, r.o. 272191



**549**  
goma amortiguador (Ø 11x38, ancho 14)  
LANDROVER, r.o.



SUSPENSION DELANTERA Y SOPORTES DE MOTOR:

W201 - W124

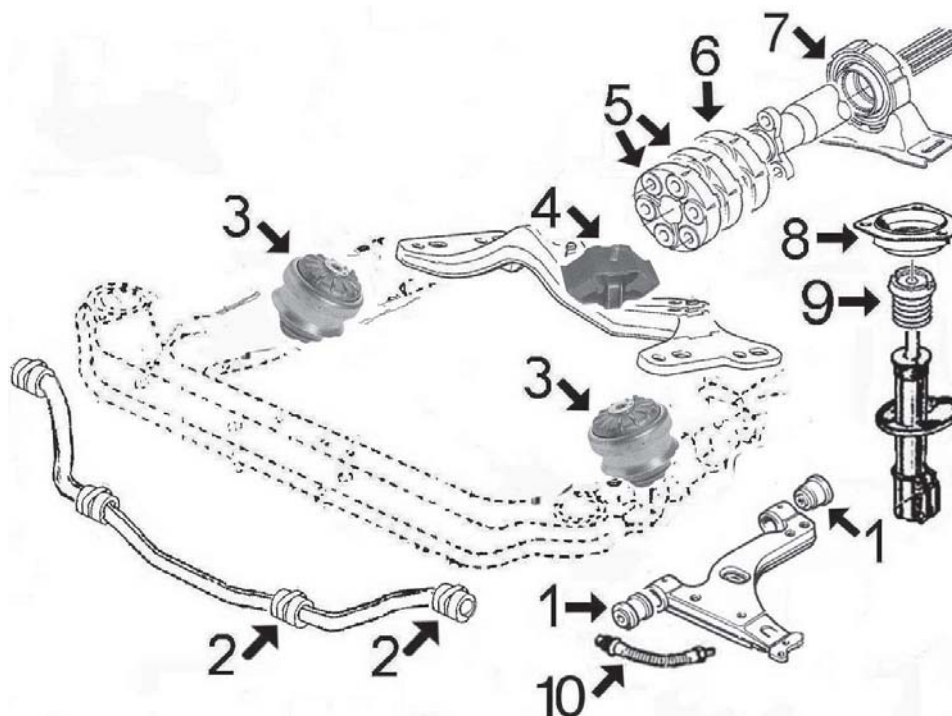

- 1- 5011 jgo reparación brazo suspensión delantero 124 hasta chasis F-711095 y W201 hasta chasis F-920107 (salvo 1.8/2.0)
- 5057 jgo reparación brazo suspensión delantero W124 desde chasis B-711096 y W201 desde chasis F-920108
- 5012 jgo reparación brazo suspensión delantero W201 190E 1.8/2.0
- 2- 5013 jgo completo gomas barra estabilizadora
- 3- 866 soporte motor derecho e izquierdo 2x4
- 4244 soporte motor derecho e izquierdo 4x4
- 4- 948 soporte cambio
- 5- 953 flector de transmisión Ø ext 127 mm (Ø círculo de agujeros 80 mm)
- 735 flector de transmisión Ø ext 115 mm (Ø círculo de agujeros 78 mm)
- 906 flector de transmisión Ø ext 132 mm (Ø círculo de agujeros 92 mm)
- 952 flector de transmisión Ø ext 129 mm (Ø círculo de agujeros 90 mm)
- 4933 flector de transmisión Ø ext 147 mm (Ø círculo de agujeros 100 mm)
- 6- 992 antivibrador árbol de transmisión Ø ext 134 mm (Ø círculo de agujeros 70 mm)
- 2480 antivibrador árbol de transmisión Ø ext 149 mm (Ø círculo de agujeros 78 mm)
- 2481 antivibrador árbol de transmisión Ø ext 132 mm (Ø círculo de agujeros 70 mm)
- 5056 antivibrador árbol de transmisión Ø ext 129 mm (Ø círculo de agujeros 70 mm)
- 7- 949 soporte transmisión completo con rodamiento (entre centros de agujeros, 110 mm y Ø rodamiento XX mm)
- 950 soporte transmisión completo con rodamiento (entre centros de agujeros, 117 mm y Ø rodamiento XX mm)
- 951 soporte transmisión completo con rodamiento (entre centros de agujeros, 117 mm y Ø rodamiento XX mm)
- 8- 2774 soporte amortiguador delantero
- 9- 5038 tope poliuretano suspensión delantera
- 10- 96193 latiguillo freno delantero (340 mm)

SUSPENSION TRASERA:

W201 - W124

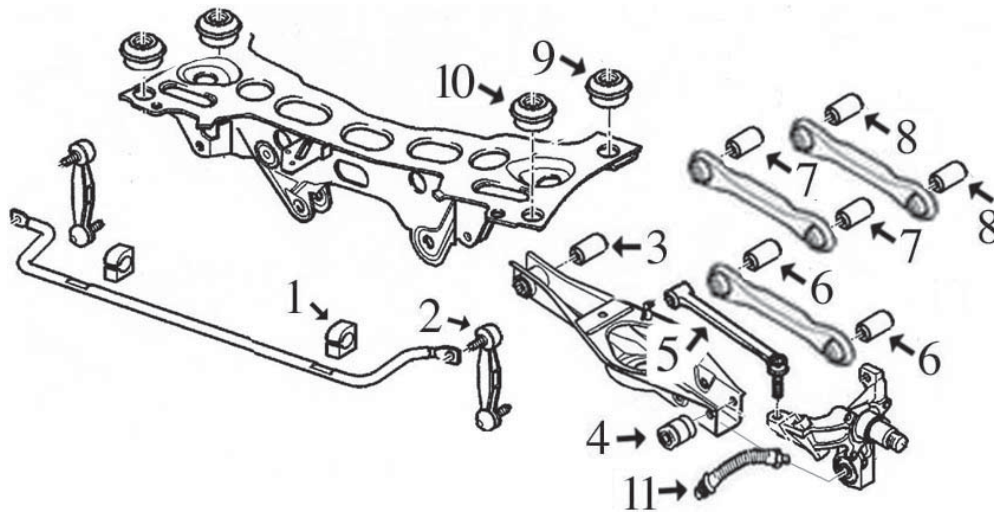

- 1- n/d goma barra estabilizadora
- 2- 5025 bieleta puntal barra estabilizadora
- 3- 5017 silentbloc interior brazo suspensión trasero
- 4- 2471 silentbloc exterior brazo suspensión trasero
- 5- 5018 bieleta tirante de reacción mangueta trasera
- 6- 4858 jgo silentblocs para tirante transversal inferior
- 7- 5016 jgo silentblocs para tirante transversal superior
- 8- 5016 jgo silentblocs para tirante transversal superior
- 9- 5022 silentbloc posterior sub-chasis trasero W201
- 5023 silentbloc posterior sub-chasis trasero W124
- 10- 5021 silentbloc anterior sub-chasis trasero
- 11- 96073 latiguillo freno trasero (310 mm)

 <p><b>735</b> flector de transmisión (Øext 115 mm), r.o. 2014100715</p>	 <p><b>866</b> soporte motor r.o. 1402402017/2117/2217</p> <p style="text-align: right;"><b>hidráulico</b></p>	 <p><b>906</b> flector de transmisión (Øext. 132 mm), r.o. 1244100115</p>
 <p><b>948</b> soporte cambio r.o. 1242400618-1242400318-1242400018</p>	 <p><b>949</b> soporte transmisión (entre centros 110 mm) con rodamiento, r.o. 2014100581</p>	 <p><b>950</b> soporte transmisión (entre centros 117 mm) con rodamiento, r.o. 1244100281</p>
 <p><b>951</b> soporte transmisión (entre centros 117mm) con rodamiento, r.o. 1244100181</p>	 <p><b>952</b> flector de transmisión (Øext. 129 mm), r.o. 2014101715</p>	 <p><b>953</b> flector de transmisión (Øext. 127 mm), r.o. 1244100015</p>

MERCEDES BENZ W201 (190, 1983-1992) - W124 (1985-1995)



**992** Ø 134 mm  
antivibrador transmisión  
r.o. 2014112347



**2471**  
silentbloc exterior brazo susp. trasera  
r.o. 2013528865 (Ø12x31.5, largo 93)



**2480** Ø 149 mm  
antivibrador transmisión  
r.o. 12441104447-1234110147



**2481** Ø 132 mm  
antivibrador transmisión  
r.o. 2024101347

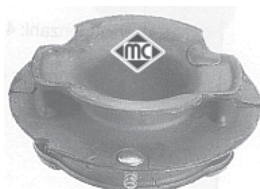

**2774**  
soporte amortiguador delantero  
r.o. 2013200744-2013202444



**4244** hidráulico  
soporte motor 4matic (4x4)  
r.o. 1402402017-2117-2217



**4858**  
jgo silentblocs tirante trasero inferior  
r.o.



**4933**  
flector de transmisión  
(Ø ext. 147 mm), r.o. 1244110515

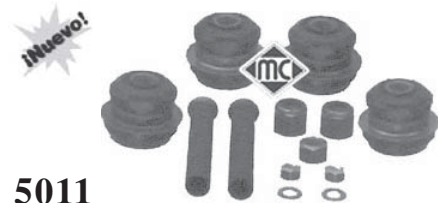

**5011**  
jgo reparación brazo suspensión delantero  
r.o. 1243300575



**5012**  
jgo reparación brazo suspensión delantero  
r.o. 2013300275



**5013**  
jgo gomas soporte barra estabilizadora  
r.o. 1243201847



**5016**  
jgo silentblocs tirantes sup. brazo trasero  
r.o. 1243523465+1243528665



**5017** (Ø 12x33, largo 58 mm)  
silentbloc interior brazo suspensión trasera  
r.o. 1243528465-2023520165



**5018**  
bieleta tirante de reacción mangueta trasera  
r.o. 2103500653-2013503253



**5021**  
soporte anterior puente trasero  
r.o. 1243511942



**5022**  
soporte posterior puente trasero  
r.o. 1243511942



**5023**  
soporte posterior puente trasero  
r.o. 1243510242



**5025**  
bieleta puntal barra estabilizadora trasera  
r.o. 1243200289



**5038**  
tope poliuretano suspensión delantera  
r.o. 1293230744

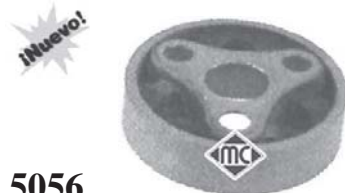

**5056** Ø 129 mm  
antivibrador transmisión  
r.o. 2024111347-2014110947



**5057**  
jgo reparación brazo suspensión delantero  
r.o. 1243300675



MERCEDES BENZ W201 (190, 1983-1992) - W124 (1985-1995)



**96193**  
latiguillo freno delantero (340 mm)  
r.o.



**96073**  
latiguillo freno trasero (310 mm)  
r.o.



**4924**  
polea cigüeñal  
r.o. 1120351300-1120351400



**4922** Ø 17x70 mm, ancho 25 mm  
rodillo tensor correa alternador  
r.o.



**4926** Ø 8x80 mm, ancho 25 mm  
rodillo tensor correa alternador  
r.o. 6012000970



**4968** (Ø 17x76 mm)  
rodillo tensor correa alternador  
r.o.



**5048** Ø 75 mm  
rodillo tensor correa alternador acanalado  
r.o. 6012000770



**3734**  
tapón llenado aceite motor  
r.o. 1110180302



**5014**  
jgo reparación reenvío dirección W201 (190)  
r.o. 2014600050



**5015**  
jgo reparación reenvío dirección W124  
r.o. 1244600119



**3733**  
conector con manguitos  
r.o. 1408326615

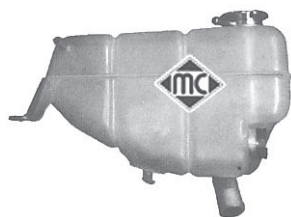

**3622**  
botella de expansión W124  
r.o. 1245001349

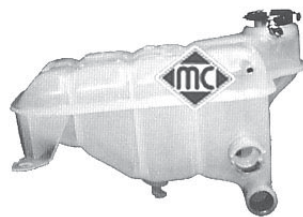

**3613**  
botella de expansión W201 (190)  
r.o. 1245001749



**3608**  
tapón de radiador 1,20 bar  
r.o.



**1783**  
kit fuelle transmisión trasera  
(Ø22-68 mm), r.o. 1243500117



**1066**  
kit fuelle transmisión trasera  
(Ø24-57 mm), r.o.



**1149**  
kit fuelle transmisión trasera  
(Ø28-57 mm), r.o. 2013500837



**678**  
tapón cárter de aceite 12x150  
r.o. 1239970430



**857**  
tapón cárter de aceite 14x150  
r.o. 1119970330



MERCEDES BENZ W201 (190, 1983-1992) - W124 (1985-1995)

**¡Nuevo!**



**4888**  
tapón 26x150  
r.o. 1309970032

**¡Nuevo!**



**5054**  
tapón 24x150  
r.o. 1159970032



**366**  
soporte tubo escape (32x59 mm)  
r.o.

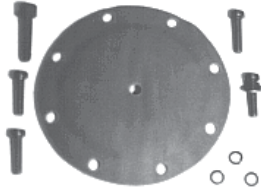









**832**  
jgo reparación bomba de vacío  
r.o. 0015860743

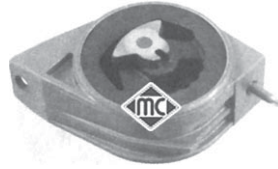

**089**  
soporte tubo de escape  
r.o. 2014920116

MERCEDES BENZ CLASE A - W168 (1997-2004)

<p><b>¡Nuevo!</b></p>  <p><b>5029</b> jgo silentblocs trapezio delantero r.o. 1683330014+1683330214</p>	<p><b>¡Nuevo!</b></p>  <p><b>5030</b> bieleta puntal barra estabilizadora delantera r.o. 1683200389</p>	<p><b>¡Nuevo!</b></p>  <p><b>5031</b> jgo reparación brazo suspensión trasero r.o. 1689810518-1689810318</p>
<p><b>¡Nuevo!</b></p>  <p><b>5050</b> soporte motor delantero r.o. 1682400618-1682401218</p>	<p><b>¡Nuevo!</b></p>  <p><b>5051</b> soporte cambio r.o. 1682401617-1682401217</p>	<p><b>¡Nuevo!</b></p>  <p><b>1134</b> kit fuelle transmisión lado rueda r.o. 1683600068</p>
<p><b>¡Nuevo!</b></p>  <p><b>4667</b> polea de cigueñal r.o. 1660300303</p>	<p><b>¡Nuevo!</b></p>  <p><b>5008</b>      Ø 50 mm - 5 canales polea de alternador de rueda libre r.o. 6681550615-6401500160</p>	<p><b>¡Nuevo!</b></p>  <p><b>5005</b>      Ø 53/50 mm - 6 canales polea de alternador de rueda libre r.o. 6111500160-6111502015-6111550215</p>

SUSPENSION DELANTERA Y SOPORTES DE MOTOR:

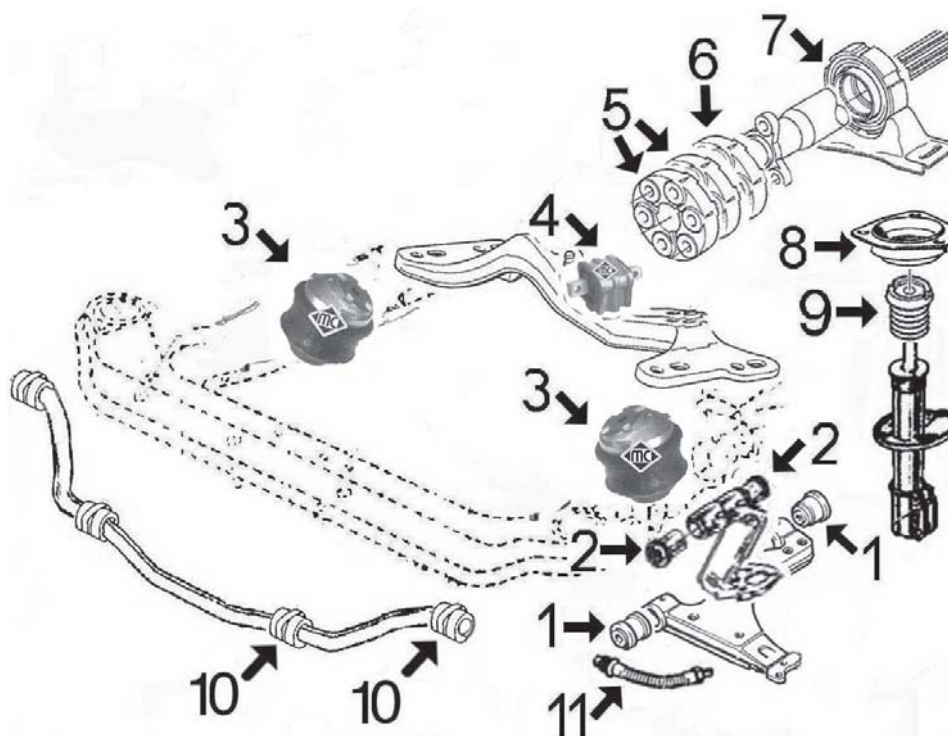

- 1- 5019 jgo reparación brazo suspensión inferior delantero W202
- 2- 4846 silentbloc brazo suspensión superior delantero W202
- 3- 4245 soporte motor derecho e izquierdo W202 y W203
- 4- 5034 soporte cambio W202 y W203
- 5- 953 flector de transmisión Ø ext 127 mm (Ø círculo de agujeros 80 mm)
- 735 flector de transmisión Ø ext 115 mm (Ø círculo de agujeros 78 mm)
- 906 flector de transmisión Ø ext 132 mm (Ø círculo de agujeros 92 mm)
- 952 flector de transmisión Ø ext 129 mm (Ø círculo de agujeros 90 mm)
- 4933 flector de transmisión Ø ext 147 mm (Ø círculo de agujeros 100 mm)
- 6- 992 antivibrador árbol de transmisión Ø ext 134 mm (Ø círculo de agujeros 70 mm)
- 2480 antivibrador árbol de transmisión Ø ext 149 mm (Ø círculo de agujeros 78 mm)
- 2481 antivibrador árbol de transmisión Ø ext 132 mm (Ø círculo de agujeros 78 mm)
- 5056 antivibrador árbol de transmisión Ø ext 129 mm (Ø círculo de agujeros 70 mm)
- 7- 5032 soporte transmisión completo con rodamiento Ø 30 mm
- 5036 soporte transmisión completo con rodamiento Ø 25 mm
- 8- 5065 soporte amortiguador delantero con rodamiento
- 9- n/d tope poliuretano suspensión delantera
- 10- 5020 jgo gomas soporte barra estabilizadora
- 11- 96212 latiguillo freno delantero (505 mm)

SUSPENSION TRASERA:

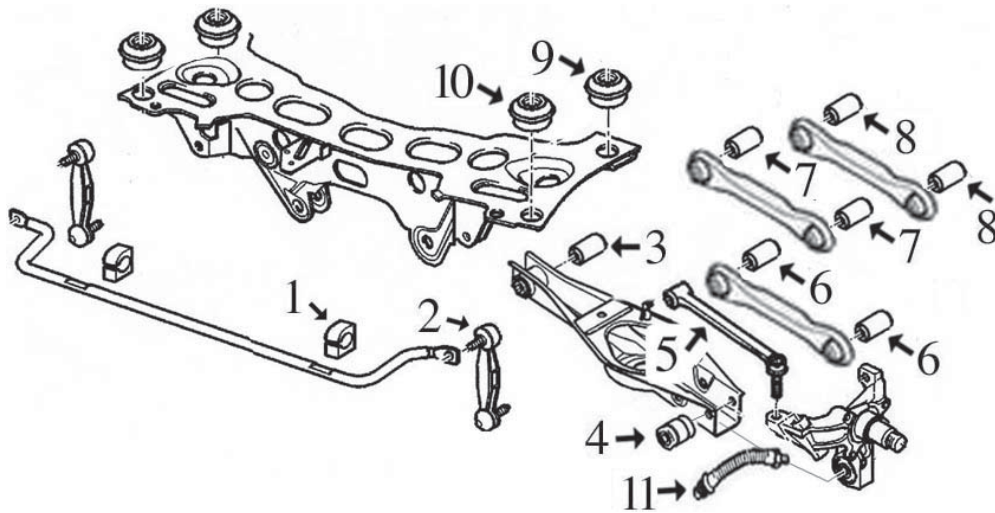

- 1- n/d goma barra estabilizadora
- 2- 5025 bieleta puntal barra estabilizadora
- 3- 5017 silentbloc interior brazo suspensión trasero
- 4- 2471 silentbloc exterior brazo suspensión trasero
- 5- 5018 bieleta tirante de reacción mangueta trasera
- 6- 4858 jgo silentblocs para tirante transversal inferior
- 7- 5016 jgo silentblocs para tirante transversal superior
- 8- 5016 jgo silentblocs para tirante transversal superior
- 9- 5023 silentbloc posterior sub-chasis trasero
- 10- 5021 silentbloc anterior sub-chasis trasero
- 11- 96073 latiguillo freno trasero (310 mm)



**735**  
flector de transmisión  
(Øext 115 mm), r.o. 2014100715



**906**  
flector de transmisión  
(Øext. 132 mm), r.o. 1244100115



**952**  
flector de transmisión  
(Øext. 129 mm), r.o. 2014101715

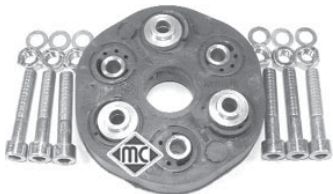

**953**  
flector de transmisión  
(Øext. 127 mm), r.o. 1244100015



**992** Ø 134 mm  
antivibrador transmisión  
r.o. 2014112347



**2471**  
silentbloc exterior brazo susp. trasera  
r.o. 2013528865 (Ø 12x31.5, largo 93)



**2480** Ø 149 mm  
antivibrador transmisión  
r.o. 12441104447-1234110147



**2481** Ø 132 mm  
antivibrador transmisión  
r.o. 2024101347





MERCEDES BENZ CLASE C - W202 (1992-2001) y W203 (2001- )



**4245**  
soporte motor derecho e izquierdo  
r.o.2022402817-2022403417

**¡Nuevo!**



**4846**  
silentbloc brazo superior suspensión  
r.o. monta en 2083300507-2103308807

**¡Nuevo!**

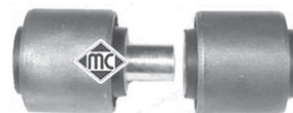

**4858**  
jgo silentblocs tirante trasero inferior  
r.o.1243529065+1243523465

**¡Nuevo!**

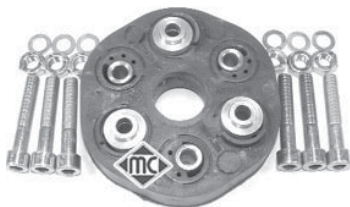

**4933**  
flector de transmisión  
(Ø ext. 147 mm), r.o. 1244110515

**¡Nuevo!**

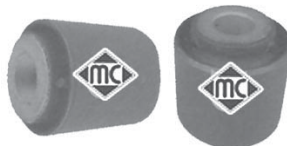

**5016**  
jgo silentblocs tirantes sup. brazo trasero  
r.o.1243523465+1243528665

**¡Nuevo!**

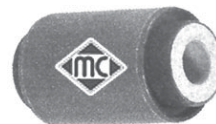

**5017** (Ø 12x33, largo 58 mm)  
silentbloc interior brazo suspensión trasera  
r.o.1243528465-2023520165

**¡Nuevo!**



**5018**  
bieleta tirante de reacción mangueta trasera  
r.o.2103500653-2013503253

**¡Nuevo!**



**5019**  
jgo reparación brazo inferior delantero  
r.o.2023300075

**¡Nuevo!**



**5020**  
jgo gomas soporte barra estabilizadora  
r.o.2023230285

**¡Nuevo!**



**5021**  
soporte anterior puente trasero  
r.o.1243511942

**¡Nuevo!**



**5023**  
soporte posterior puente trasero  
r.o.1243510242

**¡Nuevo!**



**5025**  
bieleta puntal barra estabilizadora trasera  
r.o.1243200289

**¡Nuevo!**



**5032**  
soporte árbol transmisión con rodamiento de  
Ø30 mm, r.o. 2024100581/S

**¡Nuevo!**

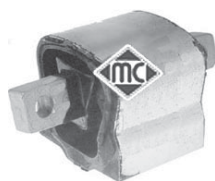

**5034**  
soporte cambio W202-W203  
r.o.2102400118

**¡Nuevo!**



**5036**  
soporte árbol transmisión con rodamiento  
de Ø25 mm, r.o. 2024100481/S

**¡Nuevo!**



**5056** Ø 129 mm  
antivibrador transmisión  
r.o.2024111347-2014110947

**¡Nuevo!**



**5065**  
soporte amortiguador delantero con roda-  
miento W203, r.o.2033200273



**¡Nuevo!**



**96212**  
latiguillo freno delantero (505 mm)  
r.o.

**¡Nuevo!**



**96073**  
latiguillo freno trasero (310 mm)  
r.o.

MERCEDES BENZ CLASE C - W202 (1992-2001) y W203 (2001- )

<p><b>4924</b> polea cigueñal r.o. 1120351300-1120351400</p>	<p><b>5046</b> Ø 17x64 mm, ancho 23 mm rodillo tensor correa alternador acanalado r.o. 0002020019</p>	<p><b>5048</b> Ø 75 mm rodillo tensor correa alternador r.o. 6012000770</p>
<p><b>4926</b> Ø 8x80 mm, ancho 25 mm rodillo tensor correa alternador r.o. 6012000970</p>	<p><b>5047</b> (Ø 80 mm) rodillo tensor correa alternador 2.8-3.2 r.o. 1042001070</p>	<p><b>5049</b> tensor correa alternador 200/220/270 CDi r.o. 6112000370</p>
<p><b>5004</b> Ø 61/55 mm - 6 canales polea de alternador de rueda libre r.o. 6041500060</p>	<p><b>5005</b> Ø 53/50 mm - 6 canales polea de alternador de rueda libre r.o. 6111500160-6111502015-6111550215</p>	<p><b>5006</b> Ø 61/55 mm - 6 canales polea de alternador de rueda libre r.o. 6041500160</p>
<p><b>5049</b> tensor correa alternador completo 200D r.o. 6112000370-6112000570-6112000270</p>	<p><b>5037</b> jgo reparación reenvío dirección r.o. 2024600319</p>	<p><b>3660</b> tapón botella de expansión r.o. 2105010515</p>
<p><b>1783</b> kit fuelle transmisión trasera (Ø22-68mm), r.o. 1243500117</p>	<p><b>1066</b> kit fuelle transmisión trasera (Ø24-57 mm), r.o.</p>	<p><b>1149</b> kit fuelle transmisión trasera (Ø28-57 mm), r.o. 2013500837</p>
<p><b>3734</b> tapón llenado aceite motor r.o. 1110180302</p>	<p><b>678</b> tapón cárter de aceite 12x150 r.o. 1239970430</p>	<p><b>857</b> tapón cárter de aceite 14x150 r.o. 1119970330</p>
<p><b>4888</b> tapón 26x150 r.o. 1309970032</p>	<p><b>5054</b> tapón 24x150 r.o. 1159970032</p>	<p><b>2422</b> soporte tubo escape r.o. 2024920444-2024920344</p>

SUSPENSION DELANTERA Y SOPORTES DE MOTOR:

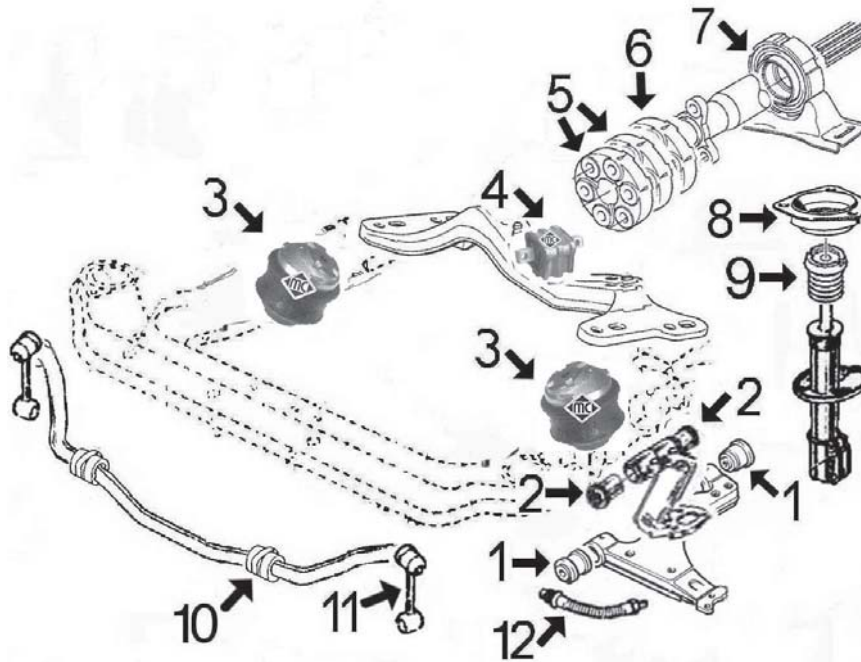

- 1- 5024 jgo reparación brazo suspensión inferior delantero W202
- 2- 4846 silentbloc brazo suspensión superior delantero W202
- 3- 4245 soporte motor derecho e izquierdo todos salvo E420  
4285 soporte motor derecho e izquierdo E420
- 4- 5034 soporte cambio W202 y W203
- 5- 953 flector de transmisión Ø ext 127 mm (Ø círculo de agujeros 80 mm)  
906 flector de transmisión Ø ext 132 mm (Ø círculo de agujeros 92 mm)  
952 flector de transmisión Ø ext 129 mm (Ø círculo de agujeros 90 mm)  
4933 flector de transmisión Ø ext 147 mm (Ø círculo de agujeros 100 mm)
- 6- 992 antivibrador árbol de transmisión Ø ext 134 mm (Ø círculo de agujeros 70 mm)  
2480 antivibrador árbol de transmisión Ø ext 149 mm (Ø círculo de agujeros 78 mm)  
2481 antivibrador árbol de transmisión Ø ext 132 mm (Ø círculo de agujeros 78 mm)  
5056 antivibrador árbol de transmisión Ø ext 129 mm (Ø círculo de agujeros 70 mm)
- 7- 5033 soporte transmisión completo con rodamiento
- 8- n/d soporte amortiguador delantero
- 9- n/d tope poliuretano suspensión delantera
- 10- 5035 goma soporte barra estabilizadora Ø 26
- 11- 5026 bieleta derecha puntal barra estabilizadora  
5027 bieleta izquierda puntal barra estabilizadora
- 12- 96085 latiguillo freno delantero (415 mm)



SUSPENSION TRASERA:

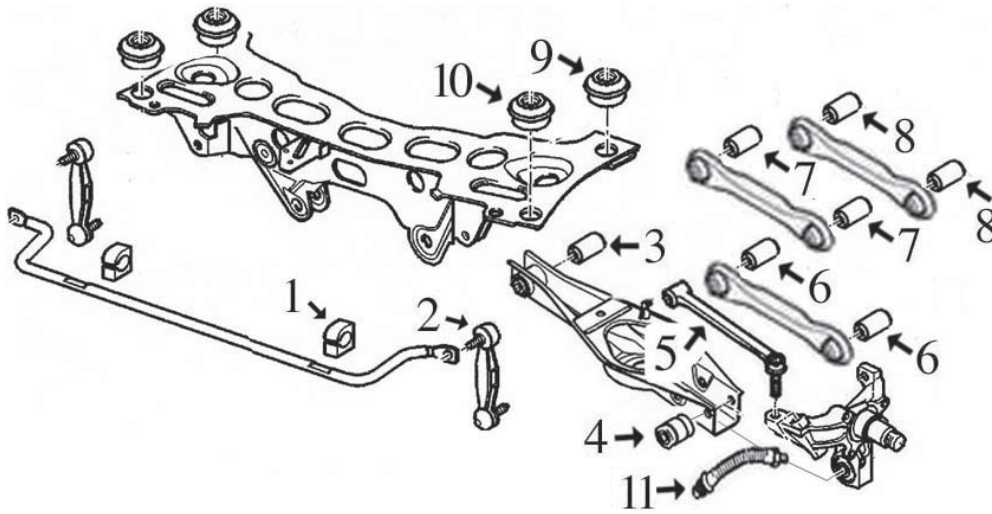

- 1- n/d goma barra estabilizadora
- 2- 5025 bieleta puntal barra estabilizadora
- 3- 5017 silentbloc interior brazo suspensión trasero
- 4- 2471 silentbloc exterior brazo suspensión trasero
- 5- 5018 bieleta tirante de reacción mangueta trasera
- 6- 4858 jgo silentblocs para tirante transversal inferior
- 7- 5016 jgo silentblocs para tirante transversal superior
- 8- 5016 jgo silentblocs para tirante transversal superior
- 9- n/d silentbloc posterior sub-chasis trasero
- 10- n/d silentbloc anterior sub-chasis trasero
- 11- 96073 latiguillo freno trasero (310 mm)



**906**  
flector de transmisión  
(Øext. 132mm), r.o. 1244100115

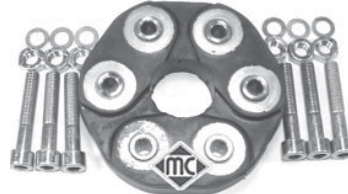

**952**  
flector de transmisión  
(Øext. 129mm), r.o. 2014101715



**953**  
flector de transmisión  
(Øext. 127 mm), r.o. 1244100015



**992** Ø 134 mm  
antivibrador transmisión  
r.o. 2014112347



**2471**  
silentbloc exterior brazo susp. trasera  
r.o. 2013528865 (Ø 12x31.5, largo 93)



**2480** Ø 149 mm  
antivibrador transmisión  
r.o. 12441104447-1234110147



**2481** Ø 132 mm  
antivibrador transmisión  
r.o. 2024101347













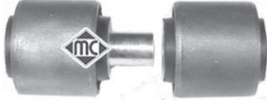

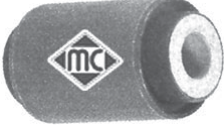



**4245**  
soporte motor derecho e izquierdo todos  
salvo E420, r.o. 2022402817-2022403417

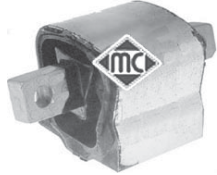







**4285**  
soporte motor derecho e izquierdo E420  
r.o. 2102402017



MERCEDES BENZ CLASE E - W210/211 (1995- )

<p><b>¡Nuevo!</b></p>  <p><b>4846</b> silentbloc brazo superior suspensión r.o.montaen2083300507-2103308807</p>	<p><b>¡Nuevo!</b></p>  <p><b>4858</b> jgo silentblocs tirante trasero inferior r.o.1243529065+1243523465</p>	<p><b>¡Nuevo!</b></p>  <p><b>4933</b> flector de transmisión (Ø ext. 147 mm), r.o. 1244110515</p>
<p><b>¡Nuevo!</b></p>  <p><b>5016</b> jgo silentblocs tirantes sup. brazo trasero r.o.1243523465+1243528665</p>	<p><b>¡Nuevo!</b></p>  <p><b>5017</b> (Ø 12x33, largo 58 mm) silentbloc interior brazo suspensión trasera r.o.1243528465-2023520165</p>	<p><b>¡Nuevo!</b></p>  <p><b>5018</b> bieleta tirante de reacción mangueta trasera r.o.2103500653-2013503253</p>
<p><b>¡Nuevo!</b></p>  <p><b>5024</b> jgo reparación brazo suspensión delantera r.o.2103300475-2103300175</p>	<p><b>¡Nuevo!</b></p>  <p><b>5025</b> bieleta puntal barra estabilizadora trasera r.o.1243200289</p>	<p><b>¡Nuevo!</b></p>  <p><b>5026</b> bieleta <b>derecha</b> puntal barra estabilizadora delantera, r.o. 2103203689</p>
<p><b>¡Nuevo!</b></p>  <p><b>5027</b> bieleta <b>izquierda</b> puntal barra estabilizadora delantera, r.o. 2103203789</p>	<p><b>¡Nuevo!</b></p>  <p><b>5033</b> soporte transmisión completo con rodamiento, r.o. 2104101281/S</p>	<p><b>¡Nuevo!</b></p>  <p><b>5034</b> soporte cambio r.o.2202400518-2202400218</p>
<p><b>¡Nuevo!</b></p>  <p><b>5035</b> goma barra estabilizadora delantera Ø 26 r.o.2103231485</p>	<p><b>¡Nuevo!</b></p>  <p><b>5056</b> Ø 129 mm antivibrador transmisión r.o.2024111347-2014110947</p>	<p><b>¡Nuevo!</b></p>  <p><b>96085</b> latiguillo freno delantero (415 mm) r.o.2024280735</p>
<p><b>¡Nuevo!</b></p>  <p><b>96073</b> latiguillo freno trasero (310 mm) r.o.1234280135</p>		
<p><b>¡Nuevo!</b></p>  <p><b>4924</b> polea cigueñal r.o.1120351300-1120351400</p>	<p><b>¡Nuevo!</b></p>  <p><b>4922</b> Ø 17x70 mm, ancho 25 mm rodillo tensor correa alternador r.o.</p>	<p><b>¡Nuevo!</b></p>  <p><b>5046</b> Ø 17x64 mm, ancho 23 mm rodillo tensor correa alternador acanalado r.o.0002020019</p>

## MERCEDES BENZ CLASE E - W210/211 (1995- ) y S - W140

<p><b>¡Nuevo!</b></p>  <p><b>4926</b> Ø 8x80 mm, ancho 25 mm rodillo tensor correa alternador r.o. 6012000970</p>	<p><b>¡Nuevo!</b></p>  <p><b>5047</b> (Ø 80 mm) rodillo tensor correa alternador 2.8-3.2 r.o. 1042001070</p>	<p><b>¡Nuevo!</b></p>  <p><b>5049</b> tensor correa alternador 200-220-270-280 CDi, r.o. 6112000370</p>
<p><b>¡Nuevo!</b></p>  <p><b>5004</b> Ø 61/55 mm - 6 canales polea de alternador de rueda libre r.o. 6041500060</p>	<p><b>¡Nuevo!</b></p>  <p><b>5005</b> Ø 53/50 mm - 6 canales polea de alternador de rueda libre r.o. 6111500160-6111502015-6111550215</p>	<p><b>¡Nuevo!</b></p>  <p><b>5006</b> Ø 61/55 mm - 6 canales polea de alternador de rueda libre r.o. 6041500160</p>
<p><b>1783</b> kit fuelle transmisión trasera (Ø 22-68 mm), r.o. 1243500117</p> 	<p><b>1066</b> kit fuelle transmisión trasera (Ø 24-57 mm), r.o.</p> 	<p><b>¡Nuevo!</b></p> <p><b>1149</b> kit fuelle transmisión trasera (Ø 28-57 mm), r.o. 2013500837</p> 
<p><b>¡Nuevo!</b></p>  <p><b>3734</b> tapón llenado aceite motor r.o. 1110180302</p>	<p><b>678</b> tapón cárter de aceite 12x150 r.o. 1239970430</p> 	<p><b>857</b> tapón cárter de aceite 14x150 r.o. 1119970330</p> 
<p><b>¡Nuevo!</b></p>  <p><b>4888</b> tapón 26x150 r.o. 1309970032</p>	<p><b>¡Nuevo!</b></p>  <p><b>5054</b> tapón 24x150 r.o. 1159970032</p>	<p><b>089</b> soporte tubo escape r.o. 2014920116</p> 
<p><b>¡Nuevo!</b></p>  <p><b>3660</b> tapón botella de expansión r.o. 2105010515</p>		
<p><b>4244</b> soporte motor Clase S W140 r.o. 1402402017</p> 	<p><b>4245</b> soporte motor Clase S W140 r.o. 2202401717-2202401817</p> 	<p><b>¡Nuevo!</b></p> <p><b>5034</b> soporte cambio Clase S W140 r.o. 2202400518</p> 

**MERCEDES BENZ furgonetas MB100-120-140 (1985-1996)**



**8332**  
mgto superior radiador MB-100/120/180  
r.o. 6315010482



**8333**  
mgto inferior radiador MB-100/120/180  
r.o. 6315010582



**8336**  
mgto termostato MB-90/100/120/180  
(40x50, largo 40), r.o. 900271-042017



**8334**  
mgto entrada calefactor MB-100/120/180  
r.o. 6318321523



**8335**  
mgto salida calefactor MB-100/120/180  
r.o. 9318321423



**2750**  
soporte de motor MB-90/100/120/180  
r.o. 6312410065



**2752**  
casquillo ballesta trasera MB-90/100/120/180  
r.o. 6313240050-6673220350



**2442**  
silentbloc soporte palanca de cambio  
r.o. 6679880011

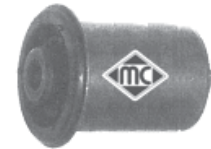

**2758**  
silentbloc brazo delantero de suspensión  
(exteriorestriado) r.o. 6313300075



**1483**  
kit fuelle transmisión l/rueda MB  
r.o. 6313300185



**1483-E**  
kit fuelle transm l/rda para montar con cono  
r.o. 6313300185



**1482**  
kit rep. transmisión l/cambio MB  
r.o. 6313300085



**013**  
cono montaje fuelles l/rueda (Ø 102 mm)  
r.o.



**449**  
soporte bomba inyectora  
r.o. 6213020085



**2370**  
soporte tubo de escape  
r.o. 3014920382



**366**  
soporte tubo de escape (Ø 32 x 59)  
r.o.



**857**  
tapón cárter de aceite 14x150 mm  
r.o. 1119970330

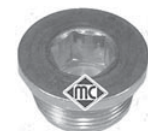

**4888**  
tapón de aceite 26x150 mm  
r.o. 1309970032

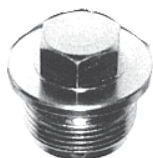

**759**  
tapón cárter de aceite 26x150 mm  
r.o.



**5054**  
tapón de aceite 24x150 mm  
r.o. 1159970032

SUSPENSION DELANTERA Y SOPORTES DE MOTOR:

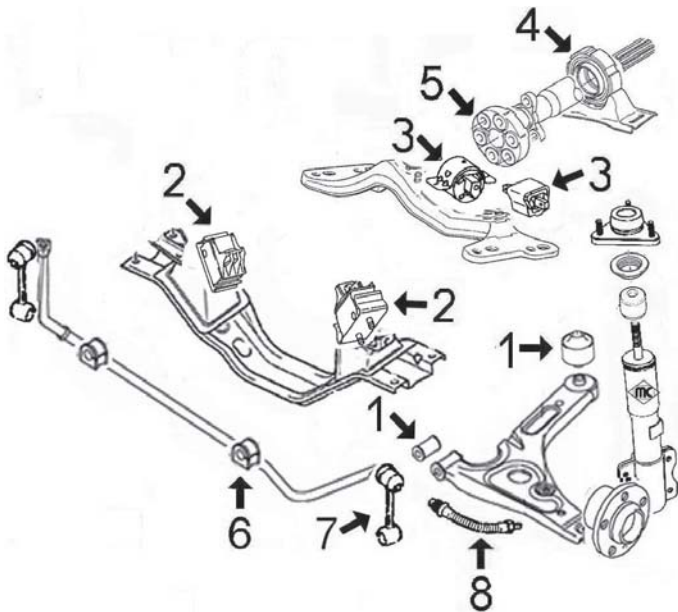









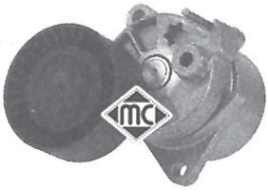

- 1- n/d jgo silentblocs trapecio delantero
- 2- 5052 soporte motor derecho e izquierdo
- 3- 5053 soporte anterior cambio 308D  
5034 soporte posterior cambio 408-411-413-414-416
- 4- 4665 soporte árbol de transmisión
- 5- 5062 antivibrador árbol de transmisión  
Ø ext. 172 mm / Ø círculo de agujeros, 100 mm
- 6- n/d goma barra estabilizadora
- 7- 5058 bieleta puntal derecho barra estabiliz. hasta -'01  
5059 bieleta puntal izquierdo barra estabiliz. hasta -'01  
5060 bieleta puntal derecho barra estabiliz. desde '01-  
5061 bieleta puntal izquierdo barra estabiliz. desde '01-
- 8- 96093 latiguillo freno delantero (363 mm)

<p><b>4665</b> soporte árbol de transmisión r.o. 9014110312</p>	<p><b>5034</b> soporte posterior cambio 408-411-413-414 r.o. 2202400518</p>	<p><b>5052</b> soporte motor derecho e izquierdo r.o. 9012412413-9012412513</p>
<p><b>5053</b> soporte anterior cambio 308D r.o. 9012421413-9012421513</p>	<p><b>5058</b> bieleta puntal <b>derecho</b> barra estabilizadora hasta -'01, r.o. 9013200389</p>	<p><b>5059</b> bieleta puntal <b>izquierdo</b> barra estabilizadora hasta -'01, r.o. 9013200289</p>
<p><b>5060</b> bieleta puntal <b>derecho</b> barra estabilizadora desde '01-, r.o. 9053200589</p>	<p><b>5061</b> bieleta puntal <b>izquierdo</b> barra estabilizadora desde '01-, r.o. 9053200489</p>	<p><b>5062</b> antivibrador árbol de transmisión (Ø ext. 172 mm) r.o. 9014110047</p>
<p><b>96093</b> latiguillo freno delantero y trasero (363 mm) r.o. 9014280435</p>		









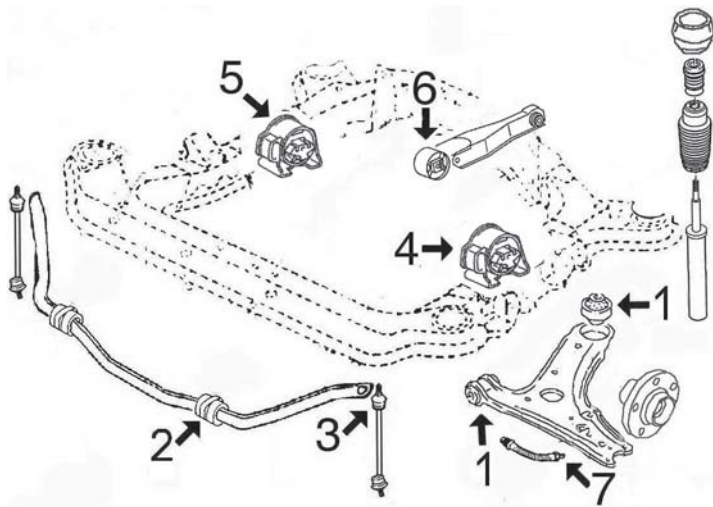



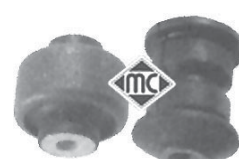

## MERCEDES SPRINTER W901/902/903/904/905 (1995- )

<p><b>iNuevo!</b></p>  <p><b>5004</b> Ø 61/55 mm - 6 canales polea de alternador de rueda libre r.o. 6041500060</p>	<p><b>iNuevo!</b></p>  <p><b>5005</b> Ø 53/50 mm - 6 canales polea de alternador de rueda libre r.o. 6111500160-6111502015-6111550215</p>	<p><b>iNuevo!</b></p>  <p><b>5006</b> Ø 61/55 mm - 6 canales polea de alternador de rueda libre r.o. 6041500160</p>
<p><b>iNuevo!</b></p>  <p><b>5047</b> Ø 80 mm rodillo tensor correa alternador 2.8 gasolina r.o. 1042001070</p>	<p><b>iNuevo!</b></p>  <p><b>5048</b> Ø 75 mm rodillo tensor correa alternador acanalado r.o. 6012000770</p>	<p><b>iNuevo!</b></p>  <p><b>5049</b> tensor correa alternador Diesel todos r.o. 6112000370</p>
<p><b>iNuevo!</b></p>  <p><b>5046</b> Ø 17x64 mm, ancho 23 mm rodillo tensor correa alternador acanalado r.o. 0002020019</p>	<p><b>iNuevo!</b></p>  <p><b>4926</b> Ø 8x80 mm, ancho 25 mm rodillo tensor correa alternador r.o. 6012000970</p>	
<p><b>iNuevo!</b></p>  <p><b>4888</b> tapón 26x150 r.o. 1309970032</p>	<p><b>iNuevo!</b></p>  <p><b>5054</b> tapón 24x150 r.o. 1159970032</p>	<p><b>iNuevo!</b></p>  <p><b>857</b> tapón cárter 14x150 r.o. 1119970330</p>











SUSPENSION DELANTERA Y SOPORTES DE MOTOR:

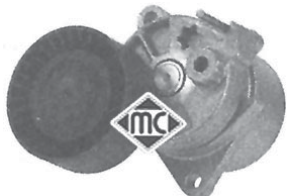

- 1- 5028 jgo silentblocs trapecio delantero
- 2- 5068 goma barra estabilizadora
- 3- 4402 bieleta puntal izquierdo barra estabilizadora
- 4403 bieleta puntal derecho barra estabilizadora
- 4- 5063 soporte motor izquierdo
- 5- 5063 soporte motor derecho
- 6- 5064 silentbloc soporte motor trasero
- 7- 96194 latiguillo freno delantero (495 mm)

 <p><b>4402</b> izquierda bieleta puntal barra estabilizadora delantera r.o. 6383230268</p>	 <p><b>4403</b> derecha bieleta puntal barra estabilizadora delantera r.o. 6383230368</p>	<p><b>5028</b> jgo. silentblocs trapecio delantero r.o.6383330014+6383330814</p> 
<p><b>5040</b> bieleta puntal barra estabilizadora trasera r.o. 6383160116</p> 	<p><b>5063</b> soporte motor derecho e izquierdo r.o. 6382411413</p> 	<p><b>5064</b> soporte motor trasero r.o. 6382420313</p> 
<p><b>5068</b> goma barra estabilizadora delantera r.o. 6383230285</p> 	<p><b>96194</b> latiguillo freno delantero y trasero (495 mm) r.o. 6384280835</p> 	<p><b>96195</b> latiguillo freno trasero (525 mm) r.o. 6384281035</p> 
<p><b>1187</b> kit fuelle transmisión lado rueda VITO (en neopreno), r.o.</p> 	<p><b>1750</b> kit fuelle transmisión lado rueda VITO (en Hytrel-termoplástico), r.o. 9903301985</p> 	<p><b>1794</b> kit fuelle transmisión lado cambio VITO r.o. 9903301785</p> 

MERCEDES VITO W638 (1996- ) - Vaneo W414 (2002- )

<p><b>¡Nuevo!</b></p>  <p><b>5004</b> Ø 61/55 mm - 6 canales polea de alternador de rueda libre r.o. 6041500060</p>	<p><b>¡Nuevo!</b></p>  <p><b>5005</b> Ø 53/50 mm - 6 canales polea de alternador de rueda libre r.o. 6111500160-6111502015-6111550215</p>	<p><b>¡Nuevo!</b></p>  <p><b>5006</b> Ø 61/55 mm - 6 canales polea de alternador de rueda libre r.o. 6041500160</p>
<p><b>¡Nuevo!</b></p>  <p><b>5047</b> Ø 80 mm rodillo tensor correa alternador 2.8 gasolina r.o. 1042001070</p>	<p><b>¡Nuevo!</b></p>  <p><b>5048</b> Ø 75 mm rodillo tensor correa alternador acanalado r.o. 6012000770</p>	<p><b>¡Nuevo!</b></p>  <p><b>5049</b> tensor correa alternador Diesel todos r.o. 6112000370</p>
<p><b>¡Nuevo!</b></p>  <p><b>5046</b> Ø 17x64 mm, ancho 23 mm rodillo tensor correa alternador acanalado r.o. 0002020019</p>	<p><b>¡Nuevo!</b></p>  <p><b>4926</b> Ø 8x80 mm, ancho 25 mm rodillo tensor correa alternador Diesel r.o. 6012000970</p>	
<p><b>¡Nuevo!</b></p>  <p><b>4888</b> tapón 26x150 r.o. 1309970032</p>	<p><b>¡Nuevo!</b></p>  <p><b>5054</b> tapón 24x150 r.o. 1159970032</p>	 <p><b>857</b> tapón cárter 14x150 r.o. 1119970330</p>

MINI - 1 (1969-1981)



**7980**  
mgto superior radiador  
r.o.39403214



**7981**  
mgto inferior radiador  
r.o.38403244

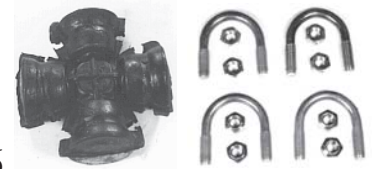

**616**  
cruceta de transmisión completa  
r.o.



**124**  
soporte tubo de escape (Ø 32, M-8)  
r.o.



**126**  
soporte tubo de escape (Ø 36, M-8)  
r.o.132022300



**2346**  
casquillo brazo suspensión delantero  
r.o.102587500



## NISSAN MICRA - PRIMERA - ALMERA



**2830**  
silentbloc anterior trapecio delt. PRIMERA  
r.o.



**2831**  
silentbloc post. trapecio delant. PRIMERA  
r.o.



**1181**  
kit rep. transmisión l/rueda MICRA 1.3 -  
PRIMERA 1.6 - ALMERA 1.4, r.o.



**2378**  
kit rep. transmisión l/rueda MICRA 1.0  
r.o.39241-01M25/01M29



**1818**  
kit rep. transmisión l/rueda PRIMERA 2.0  
ALMERA 1.6-2.0 y Diesel, r.o.

**¡nuevo!**



**3746**  
botella de expansión MICRA '03-  
r.o.

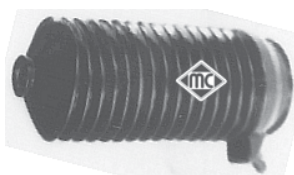

**1346**  
fuelle cremallera asistida MICRA  
r.o.

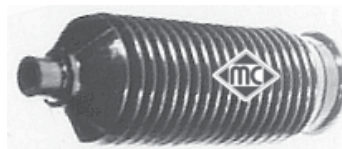

**1348**  
fuelle cremallera asistida PRIMERA - AL-  
MERA, r.o. 48203-Q9025



**4344**  
bieleta puntal barra estabiliz. MICRA  
r.o. 56261-4F725

**¡nuevo!**



**4636**  
soporte motor derecho 1.6 gasolina '02-  
r.o.



**2318**  
tapón cárter de aceite  
r.o.



**2052** Ø 12 mm      **2053** Ø 14 mm  
arandela cobre para tapón cárter  
r.o.



**3609**  
tapón de radiador 1.1 bar  
r.o.



**054**  
soporte tubo de escape MICRA  
r.o. 20650-D0102



**095**  
soporte tubo de escape PRIMERA  
r.o. 20650-69A00

**¡nuevo!**



**96092**  
latiguillo freno delantero MICRA '92-  
(483 mm), r.o. 462105F006

**¡nuevo!**



**96094**  
latiguillo freno trasero MICRA '92-  
(218 mm), r.o. 462145F000

**¡nuevo!**



**96103**  
latiguillo freno delantero **dcho.** PRIMERA  
'96- (421 mm), r.o. 462102F001

**¡nuevo!**



**96120**  
latiguillo freno delantero **izqdo.** PRIMERA  
'96- (421 mm), r.o. 462102F002

**¡nuevo!**



**96122**  
latiguillo freno trasero **dcho.** PRIMERA '96-  
(590 mm), r.o. 462102F205

**¡nuevo!**



**96123**  
latiguillo freno trasero **izquierdo** PRIMERA '96-  
(590 mm), r.o. 462102F206

**SUSPENSION DELANTERA y SOPORTES de MOTOR (tracción delantera):  
motores 1.9D (F9Q), 2.2D (G9T), 2.5D (G9U y S8U), 2.8D (S9W) y 3.0D (ZD3)**

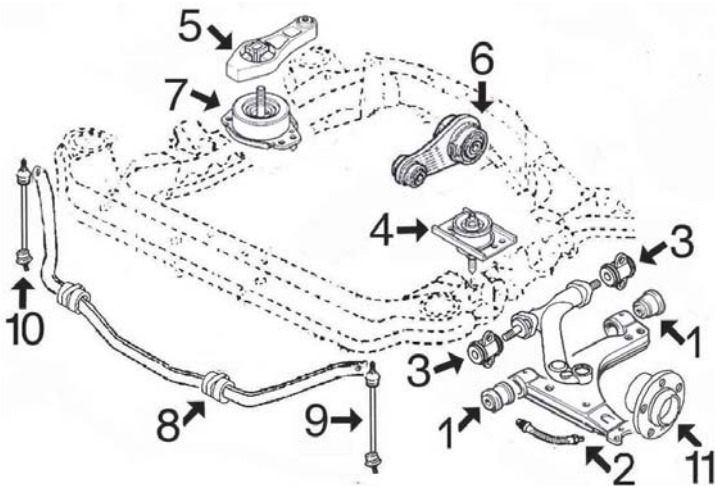





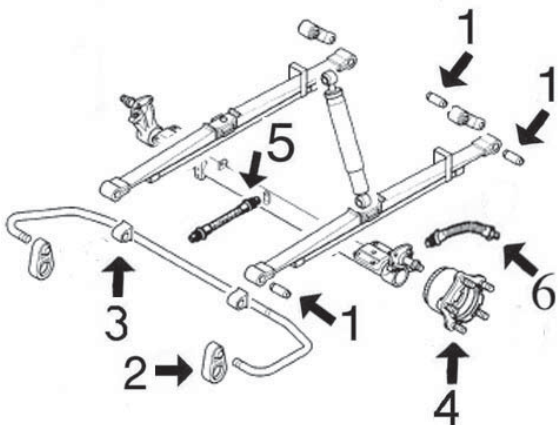







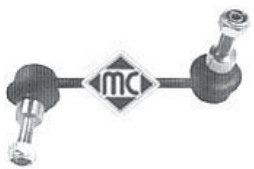
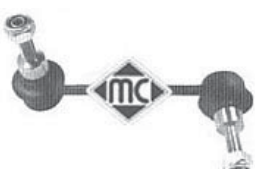

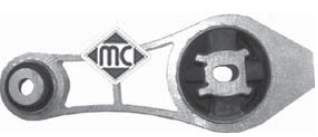
- 1- 4777 juego silentblocs trapecio inferior delantero
- 2- 96206 latiguillo freno delantero
- 3- 4778 silentbloc trapecio superior delantero
- 4- 4116 soporte motor izquierdo
- 5- 4775 tirante reacción derecho 1.9D
- 6- 4118 soporte motor trasero
- 7- 4835 soporte motor derecho 1.9DTi
- 4117 soporte motor derecho 2.5D (S8U) y 2.8D
- 4776 soporte motor derecho 2.2D y 2.5D (G9U)
- 8- 4404 goma barra estabilizadora
- 9- 4400 bieleta puntal izquierdo barra estabilizadora
- 10- 4399 bieleta puntal derecho barra estabilizadora
- 11- n/d buje rueda delantera de 15"
- n/d buje rueda delantera de 16"

**SUSPENSION TRASERA (modelos con tracción delantera)**





















- 1- 4779 juego 3 silentblocs ballesta trasera
- 2- n/d puntal barra estabilizadora trasera
- 3- n/d goma barra estabilizadora trasera
- 4- n/d buje rueda trasera
- 5- 96207 latiguillo intermedio freno trasero
- 96208 latiguillo freno trasero de 355 mm
- 96209 latiguillo freno trasero de 270 mm

## NISSAN INTERSTAR (1998- )

 <p><b>4116</b> soporte motor izquierdo todos modelos r.o. 8200199149</p>	 <p><b>4117</b> soporte motor derecho 2.5D(S8U) y 2.8D r.o. 8200022595</p>	 <p><b>4118</b> soporte motor trasero todos modelos r.o. 7700308756</p>
 <p><b>4399</b> bieleta puntal <b>derecho</b> barra estabilizadora r.o.</p>	 <p><b>4400</b> bieleta puntal <b>izquierdo</b> barra estabilizadora r.o.</p>	 <p><b>4404</b> goma barra estabilizadora delantera r.o.</p>
 <p><b>4775</b> tirante reacción en soporte derecho 1.9DTi r.o. 8200073669</p>	 <p><b>4776</b> soporte motor derecho 2.2D y 2.5D (G9U) r.o. 8200022596</p>	 <p><b>4777</b> juego silentblocs trapecio inferior delant. r.o. 7700302122+7700302123</p>
 <p><b>4778</b> silentbloc trapecio superior delantero r.o. 7700302115</p>	 <p><b>4779</b> juego silentblocs ballesta trasera r.o. 8200024453+8200024454</p>	 <p><b>4835</b> soporte motor derecho 1.9DTi r.o. 8200072229</p>
 <p><b>96206</b> latiguillo freno delantero (582 mm) r.o. 5010422700</p>	 <p><b>96207</b> latiguillo freno intermedio trasero (433 mm) r.o. 7700309823</p>	 <p><b>96208</b> latiguillo freno trasero de 355 mm r.o. 8200086894</p>
 <p><b>96209</b> latiguillo freno trasero de 270 mm r.o. 5010422009</p>		

## NISSAN INTERSTAR (1998- )

<p><b>¡Nuevo!</b></p>  <p><b>3645</b> <span style="float: right;"><b>89°</b></span> caja con termostato completa 1.9D (89°) r.o. 8200074346</p>	<p><b>¡Nuevo!</b></p>  <p><b>3661</b> <span style="float: right;"><b>83°</b></span> caja con termostato completa 1.9D (83°) r.o. 8200074349</p>	<p><b>¡Nuevo!</b></p>  <p><b>3646</b> caja de termostato completa 2.2D-2.5D, 83° r.o. 8200262237-8200262241-8200154296</p>
 <p><b>3563</b> tapón botella de expansión r.o. 7700805131</p>	 <p><b>3124</b> tubo de agua metálico 2.8HDi-Sofim S9W r.o. 7701044895</p>	<p><b>¡Nuevo!</b></p>  <p><b>3717</b> decantador completo 1.9 Diesel r.o.</p>
<p><b>¡Nuevo!</b></p>  <p><b>4455</b> <span style="float: right;"><b>6 canales</b></span> polea cigueñal 1.9 Diesel r.o. 8200079183</p>	<p><b>¡Nuevo!</b></p>  <p><b>4666</b> <span style="float: right;"><b>7 canales</b></span> polea cigueñal 1.9 Diesel r.o. 8200297937</p>	<p><b>¡Nuevo!</b></p>  <p><b>4463</b> polea cigueñal 2.2/2.5 Diesel r.o. 8200213058</p>
<p><b>¡Nuevo!</b></p>  <p><b>4585</b> <span style="float: right;"><b>7 canales</b></span> polea cigueñal 2.2/2.5 Diesel r.o. 8200207435</p>	<p><b>¡Nuevo!</b></p>  <p><b>4568</b> <span style="float: right;"><b>5+6 canales</b></span> polea cigueñal 2.8 Diesel r.o.</p>	<p><b>¡Nuevo!</b></p>  <p><b>4728</b> <span style="float: right;"><b>sólida</b></span> polea alternador <b>5 canales</b> r.o.</p>
<p><b>¡Nuevo!</b></p>  <p><b>4729</b> <span style="float: right;"><b>sólida</b></span> polea alternador <b>6 canales</b> r.o.</p>	<p><b>¡Nuevo!</b></p>  <p><b>4947</b> <span style="float: right;"><b>desembragable</b></span> polea alternador <b>5 canales</b> r.o. 8200113636</p>	<p><b>¡Nuevo!</b></p>  <p><b>4948</b> <span style="float: right;"><b>desembragable</b></span> polea alternador <b>6 canales</b> r.o. 7700110616</p>
<p><b>¡Nuevo!</b></p>  <p><b>4912</b> <span style="float: right;"><b>Ø 61,00 mm</b></span> polea de alternador <b>de rueda libre</b> r.o.</p>	<p><b>¡Nuevo!</b></p>  <p><b>4913</b> <span style="float: right;"><b>Ø 53,30 mm</b></span> polea de alternador <b>de rueda libre</b> r.o.</p>	<p><b>¡Nuevo!</b></p>  <p><b>4914</b> <span style="float: right;"><b>Ø 55,40 mm</b></span> polea de alternador <b>de rueda libre</b> r.o.</p>
<p><b>¡Nuevo!</b></p>  <p><b>4994</b> polea árbol de levas 1.9DTi-DCi (F9Q) r.o. 7700866844-7700107401</p>		



## NISSAN INTERSTAR (1998- )

 <p><b>3617</b> tapón llenado aceite motor r.o. 8200096805</p>	 <p><b>4724</b> varilla nivel aceite motor 2.2/2.5 Diesel r.o. 8200086256</p>	 <p><b>4725</b> varilla nivel aceite motor 1.9D r.o. 8200138515</p>
 <p><b>1520</b> kit fuelle transmisión l/rueda (Ø 27/90 mm) r.o. 7701473176</p>	 <p><b>1225</b> kit fuelle transmisión l/rueda (Ø 30/98 mm) r.o. 7701472975</p>	 <p><b>2304</b>      rodamiento de Ø 28.0 mm kit fuelle transmisión <b>izquierda</b> l/cambio (Ø exterior boca grande 114 mm)</p>
 <p><b>1139</b>      rodamiento de Ø 28.0 mm kit fuelle transmisión <b>izquierda</b> l/cambio (Ø exterior boca grande 105 mm)</p>	 <p><b>1135</b> kit fuelle transmisión <b>derecha</b> l/cambio r.o. 7701470910</p>	 <p><b>1107</b> fuelle cremallera dirección (Ø 13/53 mm) r.o.</p>
 <p><b>1530</b> fuelle cremallera dirección (Ø 10/42 mm) r.o. 7701470361</p>	 <p><b>667</b> tapón cárter de aceite 1.9D r.o. 7703075210</p>	 <p><b>670</b> tapón cárter de aceite 2.2/ 2.5D r.o. 7903075033</p>
 <p><b>2722</b> soporte tubo de escape todos mods. r.o.</p>	 <p><b>9095</b> mgto desvaporizador con válvula 1.9 Diesel r.o. 8200063371-8200136128</p>	 <p><b>417</b> cubrepedal freno y embrague r.o. 7700680836</p>

## NISSAN PATROL

<p><b>¡Nuevo!</b></p>  <p><b>8930</b> mgto superior radiador 2.8D desde '87 (6 cilindros), r.o. 21503-G9806</p>	<p><b>¡Nuevo!</b></p>  <p><b>8931</b> mgto inferior radiador (2 tramos) 2.8D d/'87 (6 cilindros), r.o. 21501-G9806+21501G9805</p>	<p><b>¡Nuevo!</b></p>  <p><b>8952</b> jgo mgto intercambiador 2.8D desde '87 (6 cilindros) r.o. 21306-22J00+21307-22J001</p>
 <p><b>8214</b> mgto bomba de agua 2.8D desde '87 (6 cilindros), r.o. 21069-G1500</p>	 <p><b>8222</b> juego mgto intercambiador de aceite motor 2.8D (4 cilindros, hasta '86), r.o. 79700031-1</p>	 <p><b>8223</b> mgto de tubo a bloque motor 2.8D (4 cilindros, hasta '86), r.o. 79700026-1</p>

### SUSPENSION DELANTERA y SOPORTES DE MOTOR:

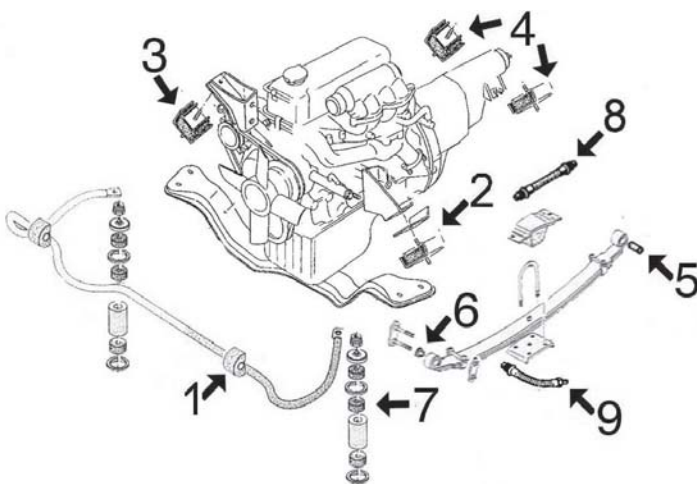





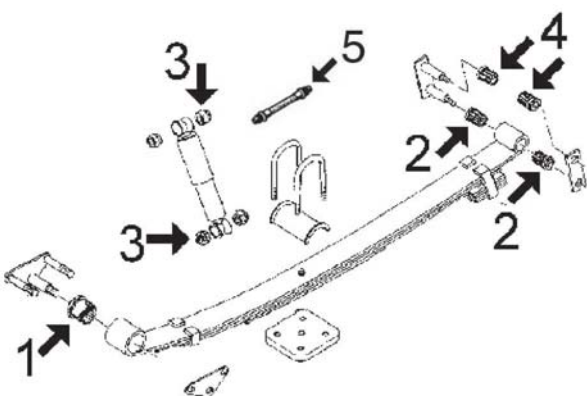









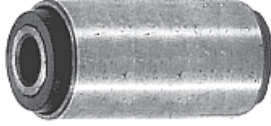

- 1- 4708 goma barra estabilizadora
- 2- 4621 soporte motor izquierdo
- 3- 4622 soporte motor derecho
- 4- 4623 soporte cambio
- 5- 739 silentbloc posterior ballesta delantera
- 6- 736 silentbloc anterior ballesta delantera (4x ballesta)
- 7- n/d puntal barra estabilizadora
- 8- 96132 latiguillo freno delantero (eje)
- 9- 96133 latiguillo freno delantero (rueda)

### SUSPENSION TRASERA:



- 1- 739 silentbloc anterior ballesta trasera
- 2- 737 silentbloc posterior ballesta trasera (inferior)
- 3- 022 goma sujeción amortiguador
- 4- 738 silentbloc posterior ballesta trasera (superior)
- 5- n/d latiguillo freno trasero

## NISSAN PATROL

 <p><b>022</b> goma sujeción amortiguadores r.o.56119-V6000/56119-32201</p>	 <p><b>736</b> casquillo ballesta delantera Ø18-40-47 largo 37, r.o. 55045-G9600</p>	 <p><b>737</b> casquillo inferior ballesta trasera Ø18-32.5-37.5 largo 37, r.o. 55046-G9601</p>
 <p><b>738</b> casquillo superior ballesta trasera Ø18-32.5-37.5 largo 51, r.o. 55046-G9600</p>	 <p><b>739</b> silentbloc ballesta delantera y trasera 16x33x60x64, r.o. 55045G9500</p>	 <p><b>4621</b> soporte motor izquierdo r.o. 11220-G9603</p>
 <p><b>4622</b> soporte motor derecho r.o. 11221-G9601</p>	 <p><b>4623</b> soporte cambio r.o. 11320-G9801</p>	 <p><b>4708</b> goma barra estabilizadora r.o.54613-G9600</p>
 <p><b>96132</b> latiguillo freno delantero (eje, 413 mm) r.o.46201R8200</p>	 <p><b>96133</b> latiguillo freno delantero (rueda, 340 mm) r.o.46204C6000</p>	
 <p><b>4017</b> silentbloc articulaciones dirección r.o.-56124-18000</p>	 <p><b>2457</b> cubrepedal freno y embrague r.o.46531-Y9500</p>	 <p><b>2398</b> tapón cárter aceite M-20x150 r.o.01641-2001M</p>
 <p><b>2318</b> tapón cárter de aceite M-12x150 r.o.</p>	 <p><b>2052</b> arandela cobre para tapón cárter Ø 12 mm r.o.</p>	

**SUSPENSION DELANTERA y SOPORTES de MOTOR:**

motores 1.9D (F9Q), 2.5D (G9U) y 2.0-16v (F4R)

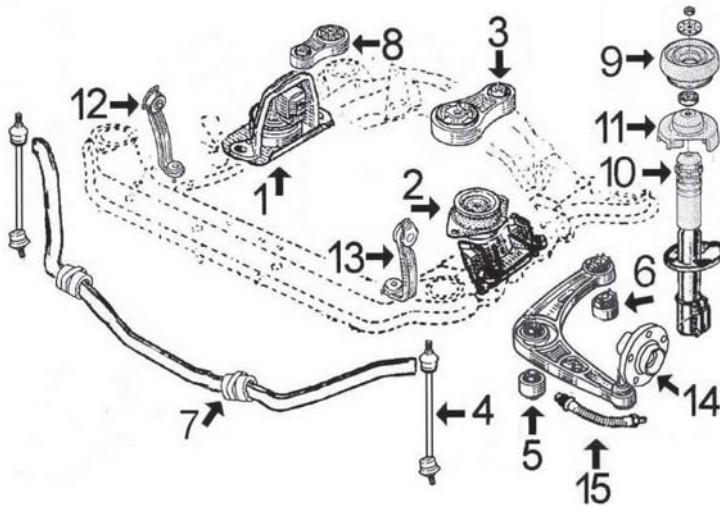

- 1- 4453 soporte motor derecho 1.9D y 2.0-16v
- 4450 soporte motor derecho 2.2D y 2.5D
- 2- 4451 soporte motor izquierdo 1.9D y 2.0-16v
- 4447 soporte motor izquierdo 2.5D
- 3- 4452 soporte motor trasero 1.9D y 2.0-16v
- 4449 soporte motor trasero 2.5D
- 4- 4457 bieleta puntal barra estabilizadora
- 5- 4487 silentbloc anterior trapecio delantero
- 6- 4488 silentbloc posterior trapecio delantero
- 7- n/d goma barra estabilizadora
- 8- 4448 bieleta antipar en soporte motor derecho todos
- 9- 4456 soporte amortiguador completo con rodamiento
- 10- 4589 capuchón amortiguador delantero
- 11- 4590 cazoleta superior muelle delantero
- 12- n/d soporte derecho subchasis delantero
- 13- n/d soporte izquierdo subchasis delantero
- 14- 90095 buje rueda delantera
- 15- 96204 latiguillo freno delantero (415 mm)



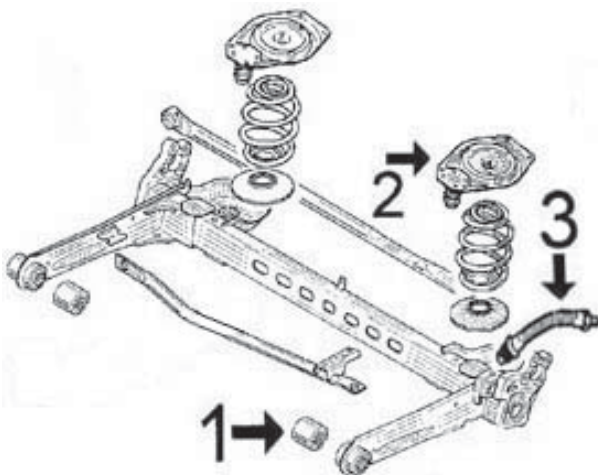













**SUSPENSION TRASERA**























- 1- 4454 silentbloc puente trasero
- 2- n/d soporte amortiguador trasero
- 3- 96205 latiguillo freno trasero (230 mm)















## NISSAN PRIMASTAR (2001- )

<p><b>¡Nuevo!</b></p>  <p><b>4447</b> soporte motor izquierdo 2.5D r.o.</p>	<p><b>¡Nuevo!</b></p>  <p><b>4448</b> tirante reacción en soporte motor derecho r.o.</p>	<p><b>¡Nuevo!</b></p>  <p><b>4449</b> soporte motor trasero 2.5D r.o.</p>
<p><b>¡Nuevo!</b></p>  <p><b>4450</b> soporte motor derecho 2.5D r.o.</p>	<p><b>¡Nuevo!</b></p>  <p><b>4451</b> soporte motor izquierdo 1.9D y 2.0-16v r.o.</p>	<p><b>¡Nuevo!</b></p>  <p><b>4452</b> soporte motor trasero 1.9D y 2.0-16v r.o.</p>
<p><b>¡Nuevo!</b></p>  <p><b>4453</b> soporte motor derecho 1.9D y 2.0-16v r.o.</p>	<p><b>¡Nuevo!</b></p>  <p><b>4454</b> silentbloc puente trasero r.o.</p>	<p><b>¡Nuevo!</b></p>  <p><b>4456</b> soporte amortiguador completo con rodam. r.o.</p>
<p><b>¡Nuevo!</b></p>  <p><b>4457</b> bieleta puntal barra estabilizadora r.o.</p>	<p><b>¡Nuevo!</b></p>  <p><b>4487</b> silentbloc anterior trapecio delantero r.o.</p>	<p><b>¡Nuevo!</b></p>  <p><b>4488</b> silentbloc posterior trapecio delantero r.o.</p>
<p><b>¡Nuevo!</b></p>  <p><b>4589</b> capuchón amortiguador delantero r.o.</p>	<p><b>¡Nuevo!</b></p>  <p><b>4590</b> cazoleta apoyo superior muelle delantero r.o.</p>	<p><b>¡Nuevo!</b></p>  <p><b>90095</b> bujе rueda delantera r.o.</p>
<p><b>¡Nuevo!</b></p>  <p><b>96204</b> latiguillo frenodelantero (415 mm) r.o. 8200404264</p>	<p><b>¡Nuevo!</b></p>  <p><b>96205</b> latiguillo freno trasero (230 mm) r.o. 82000003480</p>	

# NISSAN PRIMASTAR (2001- )

<p><b>¡Nuevo!</b></p>  <p><b>3645</b> <span style="float: right;"><b>89°</b></span>                  caja con termostato completa 1.9D (89°)                  r.o. 8200074346</p>	<p><b>¡Nuevo!</b></p>  <p><b>3661</b> <span style="float: right;"><b>83°</b></span>                  caja con termostato completa 1.9D (83°)                  r.o. 8200074349</p>	<p><b>¡Nuevo!</b></p>  <p><b>3646</b>                  caja de termostato completa 2.5D, 83°                  r.o. 8200262237-8200262241-8200154296</p>
 <p><b>3119</b>                  tapa de termostato 2.0-16v                  r.o. 7700869797</p>	 <p><b>3563</b>                  tapón botella de expansión                  r.o. 7700805131</p>	<p><b>¡Nuevo!</b></p>  <p><b>3664</b>                  botella de expansión                  r.o.</p>
<p><b>¡Nuevo!</b></p>  <p><b>4464</b> <span style="float: right;"><b>6 canales</b></span>                  polea cigueñal motor F4R 2.0-16v                  r.o. 8200276838</p>	<p><b>¡Nuevo!</b></p>  <p><b>4611</b> <span style="float: right;"><b>7 canales</b></span>                  polea cigueñal motor F4R 2.0-16v                  r.o. 8200276840-8200451073</p>	<p><b>¡Nuevo!</b></p>  <p><b>4736</b>                  polea cigueñal motor F4R 2.0-16v                  r.o. 7700116269-8200386453</p>
<p><b>¡Nuevo!</b></p>  <p><b>4455</b> <span style="float: right;"><b>6 canales</b></span>                  polea cigueñal 1.9 Diesel                  r.o. 8200079183</p>	<p><b>¡Nuevo!</b></p>  <p><b>4666</b> <span style="float: right;"><b>7 canales</b></span>                  polea cigueñal 1.9 Diesel                  r.o. 8200297937</p>	<p><b>¡Nuevo!</b></p>  <p><b>4463</b>                  polea cigueñal 2.2/2.5 Diesel                  r.o. 8200213058</p>
<p><b>¡Nuevo!</b></p>  <p><b>4585</b> <span style="float: right;"><b>7 canales</b></span>                  polea cigueñal 2.2/2.5 Diesel                  r.o. 8200207435</p>	<p><b>¡Nuevo!</b></p>  <p><b>4724</b>                  varilla nivel aceite motor 2.5 Diesel                  r.o. 8200086256</p>	<p><b>¡Nuevo!</b></p>  <p><b>4725</b>                  varilla nivel aceite motor 1.9D y 2.0                  r.o. 8200138515</p>
 <p><b>3617</b>                  tapón llenado aceite motor                  r.o. 8200096805</p>	<p><b>¡Nuevo!</b></p>  <p><b>4641</b>                  jgo. tapas árboles de levas 2.0-16v                  r.o. 7700106271+7700274026</p>	<p><b>¡Nuevo!</b></p>  <p><b>4728</b> <span style="float: right;"><b>sólida</b></span>                  polea alternador <b>5 canales</b>                  r.o.</p>
<p><b>¡Nuevo!</b></p>  <p><b>4729</b> <span style="float: right;"><b>sólida</b></span>                  polea alternador <b>6 canales</b>                  r.o.</p>	<p><b>¡Nuevo!</b></p>  <p><b>4947</b> <span style="float: right;"><b>desembragable</b></span>                  polea alternador <b>5 canales</b>                  r.o. 8200113636</p>	<p><b>¡Nuevo!</b></p>  <p><b>4948</b> <span style="float: right;"><b>desembragable</b></span>                  polea alternador <b>6 canales</b>                  r.o. 7700110616</p>

## NISSAN PRIMASTAR (2001- )

<p><b>4912</b> polea de alternador <b>de rueda libre</b> r.o. 7701473176</p> <p><i>¡Nuevo!</i></p>  <p style="text-align: center;">Ø 61,00 mm</p>	<p><b>4913</b> polea de alternador <b>de rueda libre</b> r.o. 7701473176</p> <p><i>¡Nuevo!</i></p>  <p style="text-align: center;">Ø 53,30 mm</p>	<p><b>4914</b> polea de alternador <b>de rueda libre</b> r.o. 7701473176</p> <p><i>¡Nuevo!</i></p>  <p style="text-align: center;">Ø 55,40 mm</p>
<p><b>1520</b> kit fuelle transmisión lado rueda r.o. 7701473176</p> 	<p><b>2304</b>      <b>rodamiento de Ø 28.0 mm</b> kit fuelle transmisión <b>izquierda</b> l/cambio (Ø exterior boca grande 114 mm)</p> 	<p><b>1139</b>      <b>rodamiento de Ø 28.0 mm</b> kit fuelle transmisión <b>izquierda</b> l/cambio (Ø exterior boca grande 105 mm)</p> <p><i>¡Nuevo!</i></p> 
<p><b>1135</b> kit fuelle transmisión <b>derecha</b> l/cambio r.o. 7701470910</p> <p><i>¡Nuevo!</i></p> 	<p><b>1107</b> fuelle cremallera dirección r.o. 7701473334</p> 	<p><b>4717</b> cubrepedal freno y embrague r.o. 7700416724-8200183752</p> <p><i>¡Nuevo!</i></p> 
<p><b>667</b> tapón cárter de aceite 1.9D r.o. 7703075210</p> 	<p><b>670</b> tapón cárter de aceite 2.0-16v y 2.5D r.o. 7903075033</p> 	<p><b>4474</b> soporte tubo de escape todos mods. r.o. 7700416724-8200183752</p> <p><i>¡Nuevo!</i></p> 
<p><b>9095</b> mgto desvaporizador con válvula 1.9Diesel r.o. 8200063371-8200136128</p> <p><i>¡Nuevo!</i></p> 	<p><b>3714</b> decantador completo 2.0 gasolina r.o. 7700416724-8200183752</p> <p><i>¡Nuevo!</i></p> 	<p><b>3717</b> decantador completo 1.9Diesel r.o. 7700416724-8200183752</p> <p><i>¡Nuevo!</i></p> 
<p><b>4994</b> polea árbol de levas 1.9DTi-DCi (F9Q) r.o. 7700866844-7700107401</p> <p><i>¡Nuevo!</i></p> 		

## NISSAN TERRANO-II

**¡nuevo!**



**8953**  
mgto superior radiador 2.7D  
r.o. 21501-0F111

**¡nuevo!**



**8954**  
mgto inferior radiador 2.7D (con rosca para sensor), r.o. 21503-0F112



**3609**  
tapón de radiador 1.1 bar  
r.o.

### SUSPENSION DELANTERA y SOPORTES DE MOTOR:

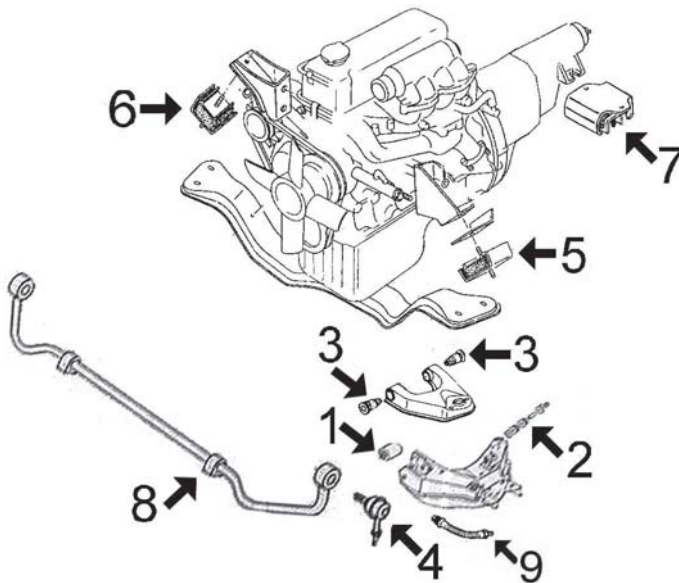

- 1- 4704 silentbloc anterior trapecio inferior delantero
- 2- 4703 silentbloc posterior trapecio inferior delantero
- 3- 4705 silentbloc trapecio superior delantero
- 4- 4237 bieleta puntal barra estabilizadora delantera
- 5- 4701 soporte motor derecho 2.4 gasolina  
4700 soporte motor derecho 2.7 D y TD
- 6- 4701 soporte motor izquierdo 2.4 gasolina  
4699 soporte motor izquierdo 2.7 D y TD
- 7- 4702 soporte cambio 2.4 gasolina y 2.7 D-TD
- 8- 4726 goma barra estabilizadora
- 9- 96127 latiguillo freno delantero derecho (343 mm)  
96129 latiguillo freno delantero izquierdo (345 mm)

### SUSPENSION TRASERA:

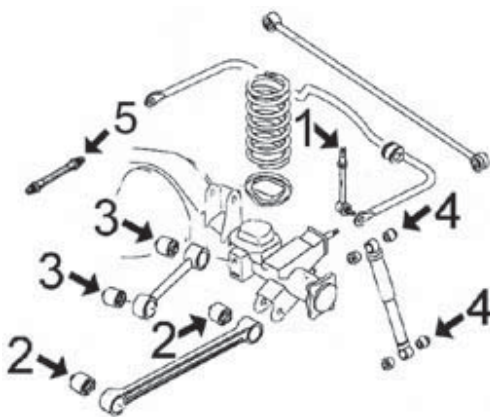

- 1- 4706 bieleta puntal barra estabilizadora trasera
- 2- 4707 silentbloc tirante de reacción exterior
- 3- 4707 silentbloc tirante de reacción interior
- 4- 022 goma sujeción amortiguador
- 5- 96130 latiguillo freno trasero (462 mm)



## NISSAN TERRANO-II

 <p><b>022</b> goma sujeción amortiguadores r.o.56119-V6000/56119-32201</p>	 <p><b>4237</b> bieleta puntal barra estabilizadora delantera r.o.</p>	 <p><b>4699</b> soporte motor derecho 2.7D-TD r.o.11210-0F002</p>
 <p><b>4700</b> soporte motor izquierdo 2.7D-TD r.o.11220-0F001</p>	 <p><b>4701</b> soporte motor 2.4 gasolina r.o.11210-0F003</p>	 <p><b>4702</b> soporte cambio 2.4 gasolina - 2.7D-TD r.o.11320-0F001</p>
 <p><b>4703</b> silentbloc posterior trapecio inferior delant. r.o.54476-01W00/54479-50W00/54477-T6000</p>	 <p><b>4704</b> silentbloc anterior trapecio inferior delant. (18x41x81x64),r.o.54560-0F001</p>	 <p><b>4705</b> silentbloc trapecio superior delantero r.o.54506-B9500</p>
 <p><b>4706</b> bieleta puntal barra estabilizadora trasera r.o.56260-0F001</p>	 <p><b>4707</b> silentbloc tirantes de reacción traseros (14x50x60x46),r.o.55045-0F000/55046-0F000</p>	 <p><b>4726</b> goma barra estabilizadora delantera r.o.54613-9C105</p>
 <p><b>96127</b> latiguillo freno delantero <b>derecho</b> (343 mm) r.o.4621050Y07</p>	 <p><b>96129</b> latiguillo freno delant. <b>izquierdo</b> (345 mm) r.o.4621050Y12</p>	
 <p><b>96130</b> latiguillo freno trasero (462 mm) r.o.462110F015</p>	 <p><b>1184</b> kit rep. transmisión l/rueda r.o.39241-10E25</p>	 <p><b>2468</b> soporte tubo de escape r.o.20641-U6810</p>
 <p><b>2318</b> tapón cárter de aceite M-12x150 r.o.</p>	 <p><b>2052</b> arandela cobre para tapón cárter Ø 12 mm r.o.</p>	 <p><b>2457</b> cubrepedal freno y embrague r.o.46531-Y9500</p>

## NISSAN TRADE - VANETTE - SERENA

### CANALIZACIONES DE AGUA:

VANETTE (HASTA '93) y TRADE, 2.0 Diesel:

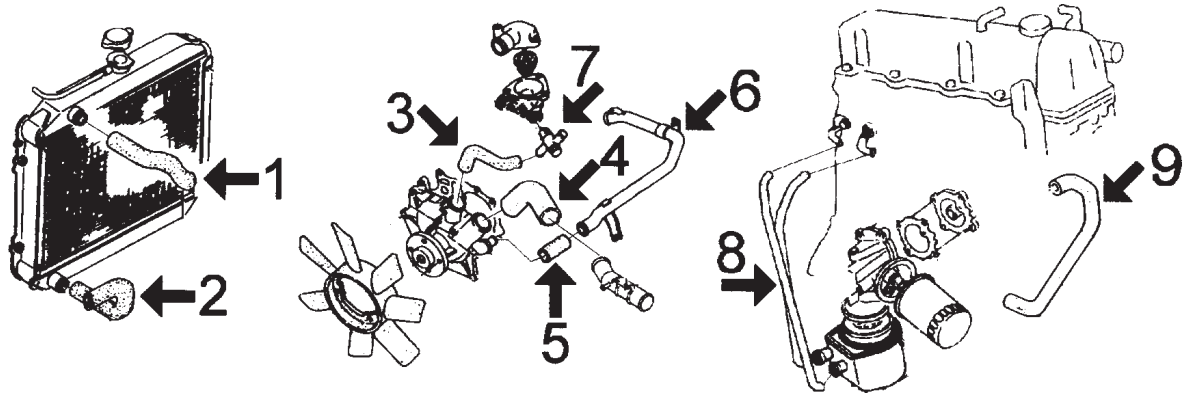

- 1- 8209 mgto superior radiador Vanette 2.0D  
8221 mgto superior radiador Trade 2.0D
- 2- 8212 mgto inferior radiador Vanette 2.0D  
8218 mgto inferior radiador Trade 2.0D
- 3- 8210 mgto de bomba de agua a racor en termostato
- 4- 8211 mgto de bomba de agua a racor entrada

- 5- 119 mgto de tubo metálico a bomba de agua: Cortar de rollo MC-119 Ø 16 x 22, longitud 98 mm
- 6- 3063 tubo de agua metálico
- 7- n/d racor 2 vias roscado en termostato
- 8- 8219 juego manguitos intercambiador filtro de aceite
- 9- 8220 mgto desvaporizador (sintético)

TRADE 2.8 Diesel:

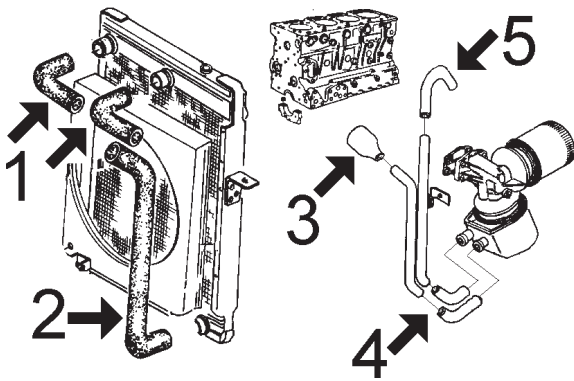

- 1- 8216 mgto superior radiador desde '12/87
- 2- 8217 mgto inferior radiador
- 3- 8213 mgto de tubo metálico a bloque motor
- 4- 8222 juego manguitos intercambiador filtro de aceite
- 5- n/d mgto de tubo metálico a bloque



**8209**  
mgto superior radiador VANETTE 2.0D hasta '93, r.o. 21501-Y9600



**8210**  
mgto bomba agua a racor en termost. VANETTE y TRADE 2.0, r.o. 14055-G5500



**8211**  
mgto de bomba de agua a racor, VANETTE y TRADE 2.0, r.o. 14056-G5501



**8212**  
mgto inferior radiador VANETTE 2.0D hasta '93, r.o. 21503-Y9603



**8213**  
mgto de tubo metálico a bloque TRADE 2.8 r.o. 79700025-1

## NISSAN TRADE - VANETTE - SERENA

 <p><b>8216</b> mgto superior radiador TRADE 2.8 desde '12/87,r.o.12105305</p>	 <p><b>8217</b> mgto inferior radiador TRADE 2.8 r.o.12105303-0</p>	 <p><b>8218</b> mgto inferior radiador TRADE 2.0 r.o.12105213-1</p>
 <p><b>8219</b> juego mgto intercambiador filtro de aceite VANETTE 2.0D-TRADE 2.0</p>	 <p><b>8220</b> mgto desvaporizador VANETTE D y TRADE 2.0,r.o.14670-G5502</p>	 <p><b>8221</b> mgto superior radiador TRADE 2.0 r.o.12105214-0</p>
 <p><b>8222</b> juego mgto intercambiador filtro de aceite TRADE 2.8,r.o.79700031-1</p>	 <p><b>3063</b> tubo de agua metálico VANETTE Diesel (hasta '93)-TRADE 2.0,r.o.21021-D9704</p>	

### SUSPENSION DELANTERA, TRASERA y SOPORTES DE MOTOR VANETTE

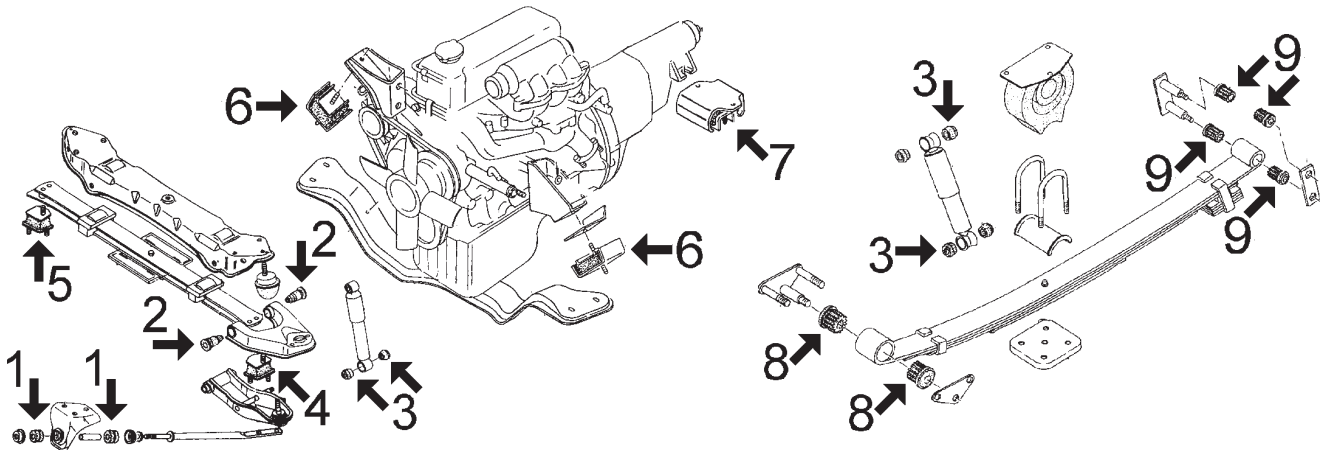

- 1- 2466 silentbloc tirante brazo delantero
- 2- 2465 silentbloc trapecio de suspensión
- 3- 022 goma fijación amortiguadores
- 4- n/d soporte izquierdo ballesta delantera (hasta '93)
- 5- n/d soporte derecho ballesta delantera (hasta '93)

- 6- 2460 soporte de motor (derecho e izquierdo hasta '93)
- 2922 soporte motor izquierdo desde '93
- 2923 soporte motor derecho desde '93
- 7- 2467 soporte trasero de motor hasta '93
- 2921 silentbloc soporte motor trasero desde '93
- 8- 2463 casquillo anterior ballesta trasera
- 9- 2464 casquillo posterior ballesta trasera

SUSPENSION DELANTERA y SOPORTES DE MOTOR, TRADE 2.0 y 2.8:

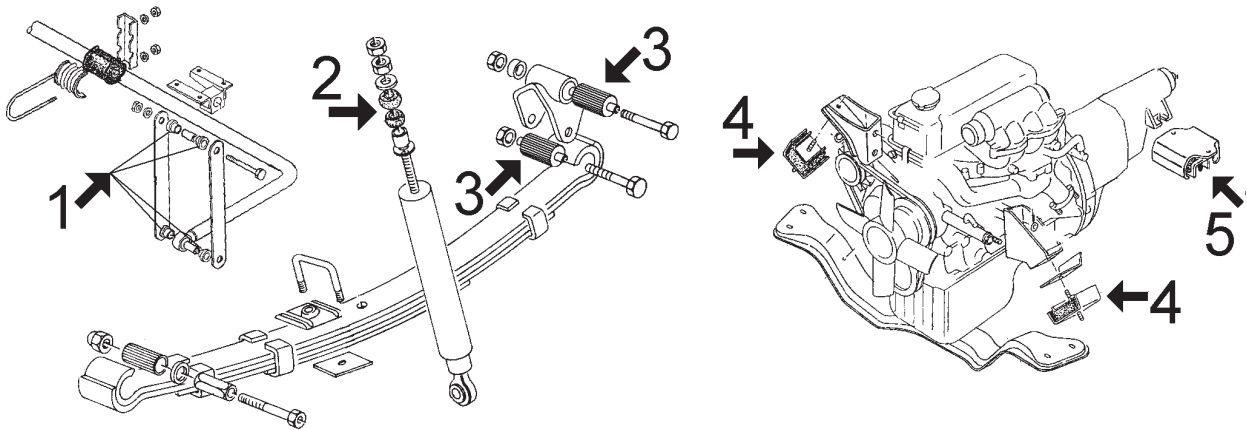

- 1- 2456 casquillo soporte barra de torsión delantera
- 2- 549 goma superior amortiguador
- 3- n/d silentbloc de ballesta

- 4- 2460 soporte de motor dcho. e izqdo. TRADE 2.0
- 404 soporte de motor dcho. e izqdo. TRADE 2.8
- 5- 2467 soporte trasero de motor TRADE 2.0

SUSPENSION TRASERA, TRADE 2.0 y 2.8:

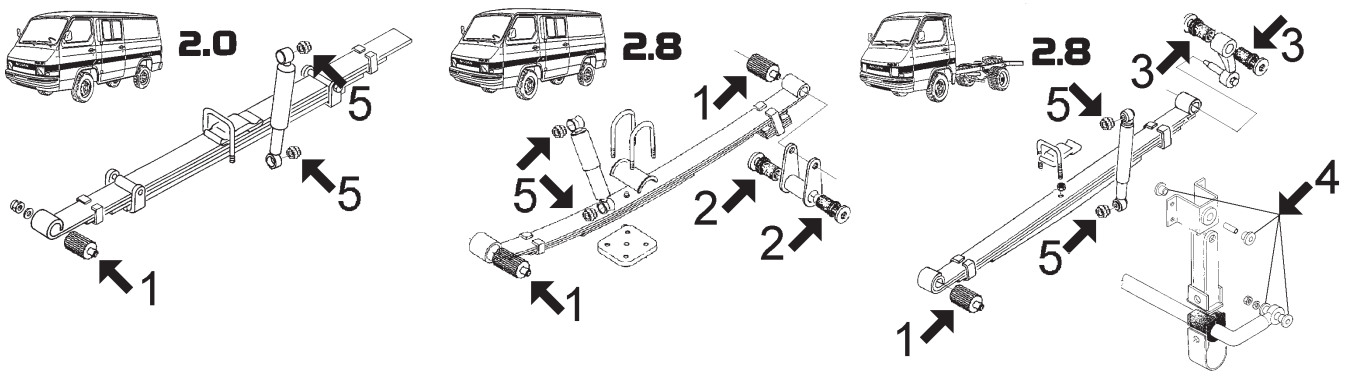

- 1- n/d silentbloc de ballesta
- 2- 2455 casquillo de goma ballesta

- 3- 2454 casquillo de goma ballesta
- 4- 2456 casquillo soporte barra de torsión trasera
- 5- 2671 casquillo de goma amortiguadores posteriores



**022**  
goma sujeción amortiguadores VANETTE  
r.o.56119-V6000



**2456**  
casquillo soporte barra de torsión TRADE  
r.o.SS-108-0103A



**2465**  
silentbloc trapecio suspensión VANETTE  
r.o.54450-G0300



**2454**  
casquillo ballesta TRADE 2.8 furgoneta  
(Ø30x42x50, largo41), r.o. 1420155-1



**2455**  
casquillo ballesta TRADE 2.8 chasis-cabina  
(Ø30x42x50, largo51), r.o. 14105041-0

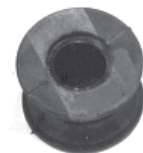

**2466**  
silentbloc tirante brazo susp. delantero  
VANETTE, r.o.54476-W5000



## NISSAN TRADE - VANETTE - SERENA



**2463**  
casquillo ballesta trasera VANETTE  
r.o.55045-G2500



**2464**  
casquillo ballesta trasera VANETTE  
r.o.55046-G8300



**2671**  
casquillo amortiguadores traseros TRADE  
r.o. no hay despiece

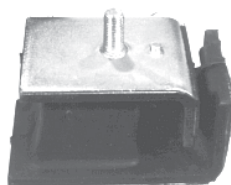

**2460**  
soporte motor VANETTE (hasta '93) y  
TRADE2.0,r.o.11221-Y9601

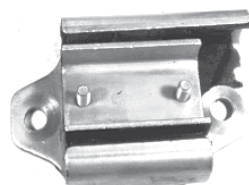

**2467**  
soporte cambio VANETTE (hasta '93) y  
TRADE2.0,r.o.11320-Y9501

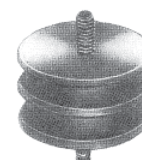

**404**  
soporte motor TRADE 2.8  
r.o.03600391-0



**2921**  
silentbloc soporte cambio VANETTE '93-  
SERENA, r.o. 11321-9C000



**2922**  
soporte motor izquierdo VANETTE '93 -  
SERENA, r.o. 11220-9C002



**2923**  
soporte motor derecho VANETTE '93 -  
SERENA, r.o. 11210-9C001



**2457**  
cubrepedal freno y embrague todos mods.  
r.o.46531-Y9500



**056**  
soporte de escape VANETTE-TRADE  
r.o.20625-H9400



**2468**  
soporte silenciador trasero VANETTE -  
TRADE,r.o.20641-U6810



**2442**  
soporte tubo escape TRADE "largo"  
(Ø25, M-8 altura 22), r.o.



**2318**  
tapón cárter de aceite VANETTE y  
TRADE2.0,r.o.11128-01M05



**2398**  
tapón cárter de aceite TRADE 2.8  
r.o.01641-2001M



**96135**  
latiguillo freno delantero derecho  
r.o.46210Y9501



**96136**  
latiguillo freno delantero izquierdo  
r.o.46211Y9600



**96137**  
latiguillo freno trasero  
r.o.46201Y9502



**96182**  
latiguillo freno delantero VANETTE d/'93-  
+ SERENA,(533 mm), r.o.462109C501



**96153**  
latiguillo freno delantero TRADE  
r.o.



**96176**  
latiguillo freno delantero F-275 (445 mm)  
r.o.

CANALIZACIONES DE AGUA:

ASTRA 1.4 - 1.6 (motores 14 SE y 16 SE de 8 válvulas)

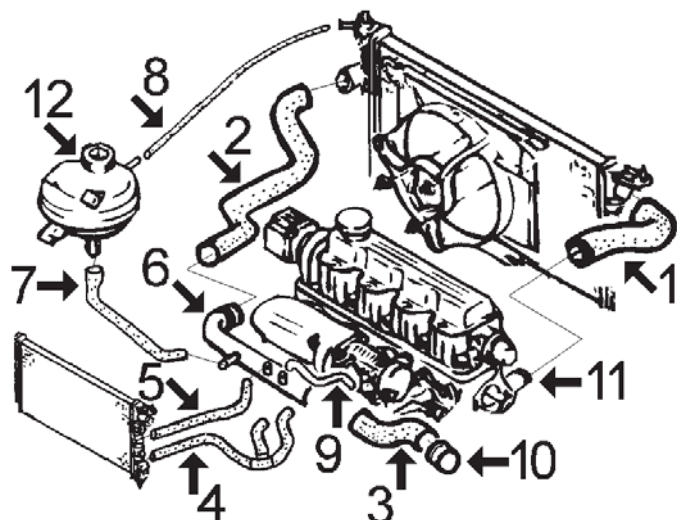

- 1- 8143 mgto superior radiador sin aire acondicionado
- 8281 mgto superior radiador con aire acondicionado
- 2- 8234 mgto inferior radiador
- 3- 8244 mgto de tubo rígido a bomba de agua
- 4- 8285 mgto de calefactor a colector de admisión
- 5- 8286 mgto de calefactor a tubo rígido
- 6- 3179 tubo de agua
- 7- 8289 mgto de botella a tubo rígido
- 8- 8327 mgto de sobrante de botella a radiador
- 9- 8250 mgto de tubo rígido a colector de admisión
- 10- 3068 boquilla metálica entrada agua a bomba
- 11- 3071 tapa de termostato (aluminio)
- 12- 3516 botella de expansión
- 3507 tapón botella de expansión
  
- 8342 mgto desvaporizador
- 8254 mgto desvaporizador

ASTRA 1.4/16v - 1.6/16v (motores X14XE y X16XEL)

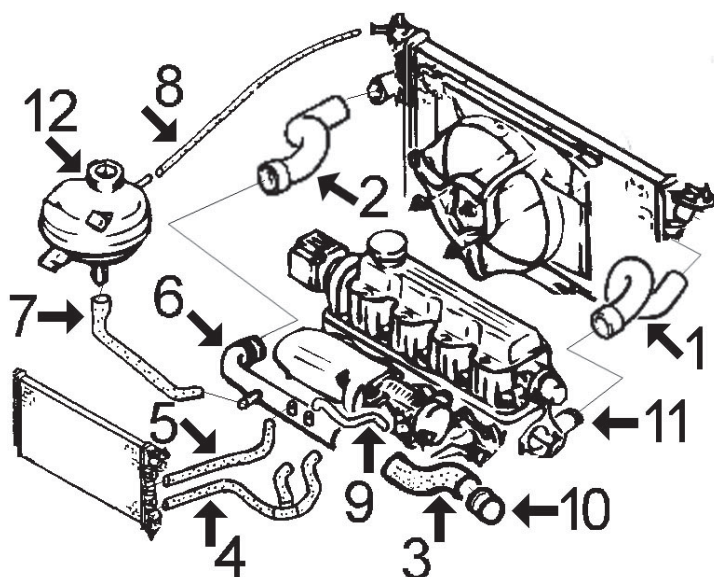

- 1- 8968 mgto superior radiador sin aire acondicionado
- 8969 mgto superior radiador con aire acondicionado
- 2- 8965 mgto inferior radiador
- 3- 8966 mgto de tubo rígido a bomba de agua 1.4/16v
- 8244 mgto de tubo rígido a bomba de agua 1.6/16v
- 4- 8285 mgto de calefactor a colector de admisión
- 5- 8286 mgto de calefactor a tubo rígido
- 6- 3182 tubo de agua
- 7- 8289 mgto de botella a tubo rígido
- 8- 8327 mgto de sobrante de botella a radiador
- 9- n/d mgto de tubo rígido a colector de admisión
- 10- 3068 boquilla metálica entrada agua a bomba
- 11- n/d tapa de termostato (aluminio)
- 12- 3516 botella de expansión
- 3507 tapón botella de expansión
  
- 9056 mgto desvaporizador

ASTRA 1.8 - 2.0 (motores 18 NZ y 20 NE de 8 válvulas)

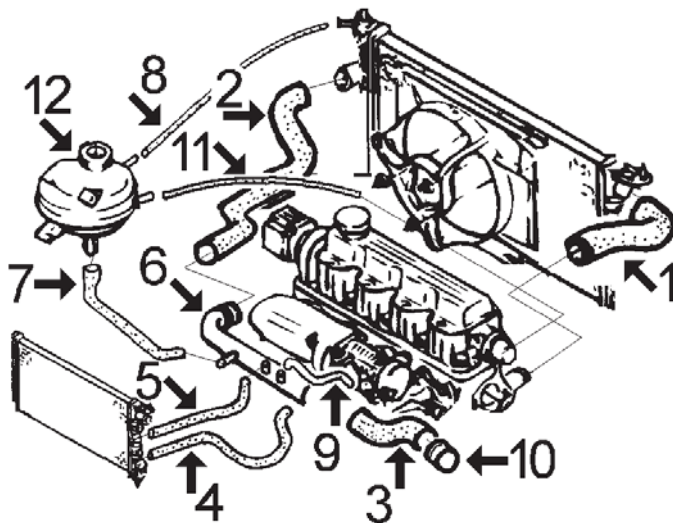

- 1- 8282 mgto superior radiador 1.8 sin aire acond. y 2.0 sin aire acond. desde '93
- 8143 mgto superior radiador 2.0 sin aire acond. h/'93
- 8283 mgto superior radiador 1.8 y 2.0 con aire acond.
- 2- 8284 mgto inferior radiador
- 3- 8009 mgto de tubo rígido a bomba de agua
- 4- 8338 mgto de calefactor a colector de admisión
- 5- 8286 mgto de calefactor a tubo rígido
- 6- 3184 tubo de agua
- 7- 8289 mgto de botella a tubo rígido
- 8- 8327 mgto de sobrante de botella a radiador
- 9- n/d mgto de tubo a colector 1.8
- 8146 mgto de tubo a bomba de agua 2.0
- 10- 3073 boquilla metálica entrada agua a bomba
- 11- 8339 mgto de sobrante de botella a tapa de termostato
- 12- 3516 botella de expansión
- 3507 tapón botella de expansión

ASTRA 2.0-16v (motor 20XE)

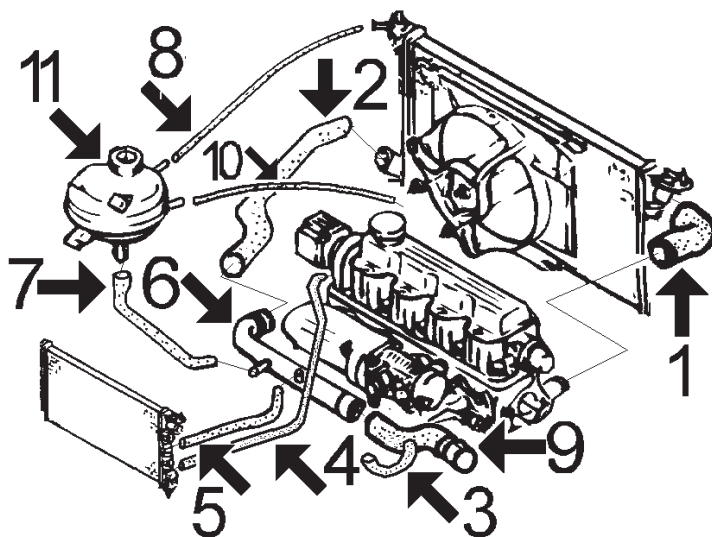

- 1- 8283 mgto superior radiador
- 2- 8284 mgto inferior radiador
- 3- 8087 mgto de tubo rígido a bomba de agua
- 4- n/d mgto de calefactor a colector
- 5- 8287 mgto de calefactor a tubo rígido
- 6- 3184 tubo de agua
- 7- 8289 mgto de botella a tubo rígido
- 8- 8327 mgto de sobrante de botella a radiador
- 9- 3073 boquilla metálica entrada agua a bomba
- 10- 8339 mgto de sobrante de botella a termostato
- 11- 3516 botella de expansión
- 3507 tapón botella de expansión

ASTRA 1.7 D y DTL:

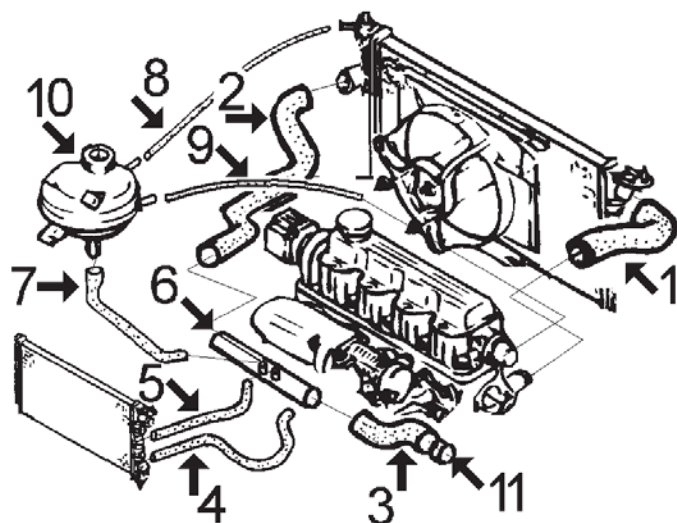

- 1- 8154 mgto superior radiador 1.7D  
8850 mgto superior radiador 1.7DTL
  - 2- 8012 mgto inferior radiador 1.7D  
8851 mgto inferior radiador 1.7DTL
  - 3- 7323 mgto de tubo metálico a bomba de agua
  - 4- 7683 mgto de calefactor a bomba de agua
  - 5- 8288 mgto de calefactor a tubo rígido
  - 6- 3076 tubo de agua metálico (aluminio) con juntas tóricas
  - 7- 8289 mgto de botella a tubo rígido
  - 8- 8327 mgto de sobrante de botella a radiador
  - 9- 8339 mgto de sobrante de botella a termostato
  - 10- 3507 tapón botella de expansión sin sensor de nivel  
3516 botella de expansión
  - 11- 3073 boquilla metálica entrada agua a bomba
- 
- 8254 mgto desvaporizador
  - 8341 mgto desvaporizador

ASTRA 1.7 TURBOD (motor ISUZU):

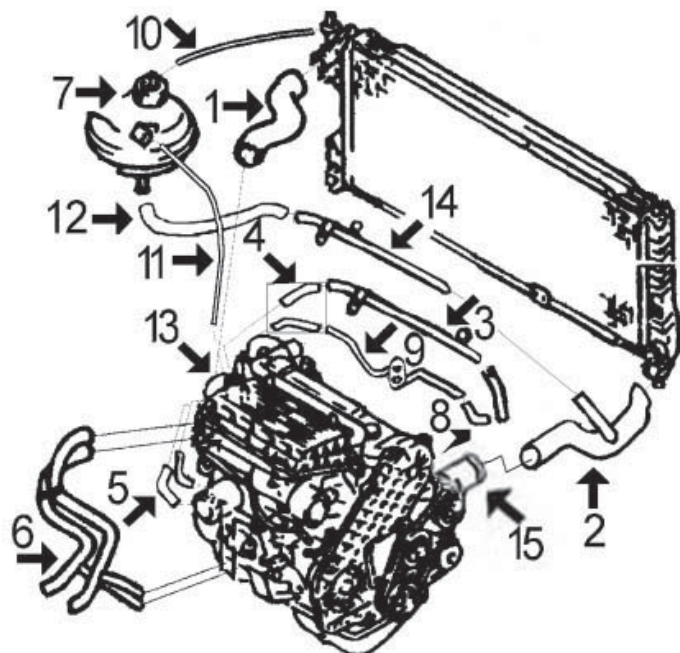

- 1- 8326 mgto superior radiador
- 2- 8277 mgto inferior radiador
- 3- 3160 tubo de agua metálico hasta '94  
3127 tubo de agua metálico desde '94
- 4- 8996 juego mgto de caja termostato a tubo metálico
- 5- 8196 juego mgto de intercambiador filtro de aceite
- 6- 8280 mgto doble de calefactor
- 7- 3507 tapón botella de expansión
- 8- 8033 mgto unión tubos metálicos
- 9- 3161 tubo de agua metálico a Turbo con junta
- 10- 8272 mgto de sobrante de botella a radiador
- 11- 8339 mgto de sobrante de botella a termostato
- 12- 8289 mgto de botella a tubo metálico
- 13- 3162 caja de termostato
- 14- 3159 tubo de agua metálico enlace mgto inferior con mgto a botella expansión
- 15- 4693 boquilla aluminio en bloque hasta '95  
4713 boquilla aluminio en bloque desde '95



**OPEL ASTRA - F (1992-1998)**



**7323**

mgto de tubo a bomba de agua 1.7 Diesel  
r.o. 1336294 - 1337395



**7683**

mgto de calefactor a bomba 1.7 Diesel  
r.o. 1818159



**8009**

mgto bomba de agua 1.8-2.0  
r.o. 1336812

bocas Ø 32-37 mm



**8012**

mgto inferior radiador 1.7 Diesel  
r.o. 1337111



**8033**

mgto de unión tubos metálicos 1.7 TurboD  
r.o.



**8087**

mgto de tubo rígido a bomba de agua 16v  
r.o. 1337393



**8143**

mgto superior radiador 1.4-1.6-2.0  
r.o. 1337389 - 1337103



**8146**

mgto de tubo rígido a bomba 1.8-2.0  
r.o. 1336509



**8154**

mgto superior radiador 1.7 Diesel  
r.o. 1337106



**8196**

juego mgts intercambiador 1.7 TurboD  
r.o. 650872 - 650873



**8234**

mgto inferior radiador 1.4-1.6  
r.o. 1337116



**8244**

mgto de tubo a bomba de agua 1.4-1.6  
r.o. 1337095

bocas Ø 30-39 mm



**8250**

mgto de tubo rígido a colector 1.4-1.6  
r.o. 1337383



**8254**

mgto desvaporizador 1.4-1.6 y Diesel  
r.o. 656234



**8272**

mgto sobrante de botella a radiador 1.7TD  
r.o. 1337118



**8277**

mgto inferior radiador 1.7 TurboD  
r.o. 1337098



**8280**

mgto doble de calefactor 1.7 TurboD  
r.o. 1818204 - 6818310



**8281**

mgto superior radiador 1.4-1.6 aire acond.  
r.o. 1337138



**8282**

mgto superior radiador 1.8-2.0  
r.o. 1337103 - 1337388



**8283**

mgto superior radiador 1.8-2.0 aire acond.  
y 16v, r.o. 1337218

OPEL ASTRA - F (1992-1998)



**8284**  
mgto inferior radiador 1.8-2.0  
r.o. 1337209



**8285**  
mgto de calefactor a colector 1.4-1.6  
r.o. 1818245



**8286**  
mgto de calefactor a tubo rígido 1.4-1.6  
r.o. 1818201



**8287**  
mgto izquierdo de calefactor 2.0 16v.  
r.o. 1818203



**8288**  
mgto de calefactor a tubo 1.7 Diésel  
r.o. 1818202



**8289**  
mgto de botella a tubo 1.4-1.6-1.8-2.0-1.7D  
r.o. 1337112-1337392



**8326**  
mgto superior radiador 1.7 TurboD  
r.o. 1337107



**8327**  
mgto sobrante de botella a radiador todos  
salvo TD, r.o. 1337141



**8338**  
mgto de calefactor a colector 1.8-2.0  
r.o. 1818580



**8339**  
mgto de sobrante de botella a termostato 1.8  
2.0-D-TD, r.o. 1337100-1337101-1337099



**8341**  
mgto desvaporizador 1.7 Diesel  
r.o. 656237



**8342**  
mgto desvaporizador 1.4-1.6  
r.o. 656236



**8850**  
mgto superior radiador 1.7DTL  
r.o.



**8851**  
mgto inferior radiador 1.7DTL  
r.o.



**8965**  
mgto inferior radiador 1.4/16v-1.6/16v  
r.o.



**8966**  
mgto de tubo a bomba 1.4/16v  
r.o.



**8968**  
mgto superior radiador 1.4-16v/1.6-16v sin  
aire acondicionado, r.o.



**8969**  
mgto superior radiador 1.4-16v/1.6-16v con  
aire acondicionado, r.o.



**8996**  
juego mgto de tubo metálico a caja de ter-  
mostato, r.o.



**9056**  
mgto desvaporizador 1.4/16v-1.6/16v  
r.o.

OPEL ASTRA - F (1992-1998)



**3507**  
tapón botella de expansión (1,20 bar)  
r.o. 1304667



**3516**  
botella de expansión gasolina y Diesel  
r.o. 1304643 (=1304642+tapón)



**2356** Ø 41x48 mm  
junta de termostato  
r.o.



**2357** Ø 46x56 mm  
junta de termostato  
r.o.



**3071**  
tapa de termostato 1.4-1.6  
r.o. 1338151



**3068** Ø 30 mm  
boquilla metálica en bloque-bomba de agua  
1.4-1.6, r.o. 606400



**3073** Ø 34 mm  
boquilla metálica en bloque-bomba de agua  
1.8-2.0-16v y Diesel, r.o. 606401



**3076**  
tubo de agua metálico 1.7 Diesel con juntas  
tóricas, r.o. 1336061



**3127**  
tubo de agua metálico 1.7TurboD desde '94  
r.o. 1337232



**3159**  
tubo de agua metálico 1.7 TurboD empalme  
mgto inferior a mgto de botella, r.o.



**3160**  
tubo de agua metálico 1.7TurboD hasta '94  
r.o. 1336067



**3161**  
tubo de agua metálico a Turbo 1.7TD con  
junta, r.o. 1336066



**3162**  
caja de termostato 1.7TurboD  
r.o. 1338182

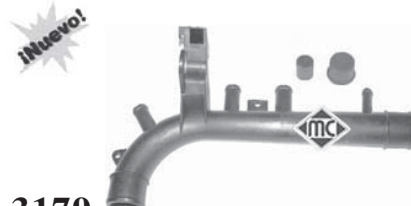

**3179**  
tubo de agua 1.4-1.6  
r.o.



**3182**  
tubo de agua 1.4/16v-1.6/16v  
r.o.



**3184**  
tubo de agua 1.8-2.0-2.0/16v  
r.o.



**4693**  
boquilla aluminio en bloque 1.7TD hasta  
'95, r.o. 606406



**4713**  
boquilla aluminio en bloque 1.7TD desde  
'95, r.o. 1338323

SUSPENSION DELANTERA y SOPORTES DE MOTOR:

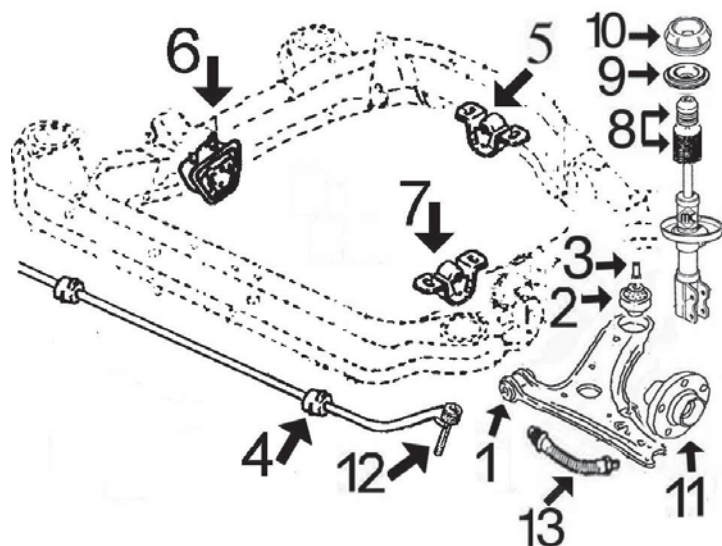

- 1- 982 silentbloc anterior trapecio delantero
- 2- 983 silentbloc posterior trapecio delantero
- 3- 4027 casquillo en silentbloc posterior trapecio
- 4- 2710 goma barra estabilizadora
- 5- 2672 soporte de motor trasero
- 6- 797 soporte de motor derecho 1.4-1.6-y Diesel manual
- 4737 soporte motor derecho 1.4/1.6 automáticos
- 797 soporte de motor derecho 1.8-2.0 y 16v. hasta '93
- 2682 soporte de motor derecho 1.8-2.0 y 16v. desde '93
- 4004 soporte de motor derecho 1.7 TurboD
- 7- 728 soporte de motor izquierdo todos
- 8- 4727 juego tope poliuretano y fuelle amortg. delantero
- 9- 4949 tapa aluminio con rodamiento
- 10- 2662 soporte amortiguador
- 11- 90004 buje rueda delantera 1.4-1.6 (22 estrías)
- 90005 buje rueda delantera 1.8-2.0 (33 estrías, Ø disco 66 mm) hasta '95
- 90043 buje rueda delantera 1.8-2.0 (33 estrías, Ø disco 56 mm) hasta '95
- 90042 buje rueda delantera 1.7D-TD de 22 estrías
- 90005 buje rueda delantera 1.7D-TD de 33 estrías
- 12- 2628 bieleta puntal para barra estabiliz. de Ø 22 mm hasta '95
- 2629 bieleta puntal para barra estabiliz. de Ø 18 mm hasta '95
- 4282 bieleta puntal barra estabilizadora desde '95 (con rótula)
- 640 goma bieleta puntal barra estabilizadora
- 13- 96158 latiguillo freno delantero (310 mm)



**982**  
silentbloc posterior trapecio delantero  
r.o. 352300



**983**  
silentbloc anterior trapecio delantero  
r.o. 352348



**4027**  
casquillo en silentbloc posterior trapecio  
r.o. 353460



**2628**  
para barra de Ø 22 mm  
bieleta puntal barra estabilizadora completa  
hasta '95, r.o. 350260+350153



**2629**  
para barra de Ø 18 mm  
bieleta puntal barra estabilizadora completa  
hasta '95, r.o. 350261+350153



**640**  
goma bieleta puntal barra estabilizadora  
r.o. 350123



**2662**  
soporte amortiguador delantero  
r.o. 344517

**¡Nuevo!**



**4949**  
tapa aluminio con rodamiento soporte  
amortiguador, r.o. 0344524

**¡Nuevo!**



**4727**  
tope poliuretano amortiguador delantero  
y TD, r.o. 344401



## OPEL ASTRA - F (1992-1998)



**4282**  
bieleta puntal barra estabilizadora desde '95  
'95, r.o. 350263



**2708**  
silentbloc brazo suspensión trasera  
r.o. 402645



**2710**  
goma barra estabilizadora delantera  
r.o. 350123-350078-350081



**96158**  
latiguillo freno delantero (310 mm)  
r.o. 562345



**96041**  
latiguillo freno trasero berlina (235 mm)  
r.o. 562352



**96159**  
latiguillo freno trasero familiar (195 mm)  
r.o. 562346



**797**  
soporte motor derecho salvo 2.0, 16v y TD  
r.o. 684283-684667-684291



**2682**  
soporte motor derecho 1.8-2.0 y 16v.  
r.o. 642007-684646

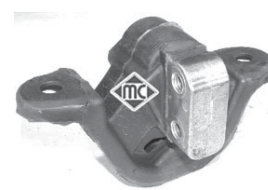

**4004**  
soporte motor derecho 1.7 TurboDiesel  
r.o. 684644



**728**  
soporte motor izquierdo  
r.o. 684289-684285-684641-684643

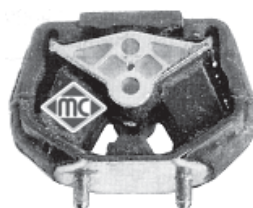

**2672**  
soporte motor trasero  
r.o. 682601-684647-682504



**4737**  
soporte motor derecho 1.4-1.6 automáticos  
r.o. 684134



**90004**  
bujes rueda delantera 1.4-1.6 (22 estrías)  
r.o. 326197

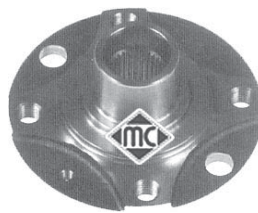

**90005**  
bujes rueda delata 1.8-2.0 hasta '95 y 1.7D-TD  
de 33 estrías, Ø disco 66 mm, r.o. 326184



**90043**  
bujes rueda delantera 1.8-2.0 desde '95  
(33 estrías, Ø disco 56 mm), r.o. 326194





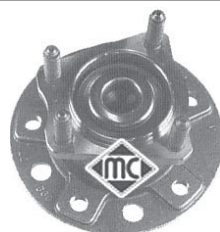











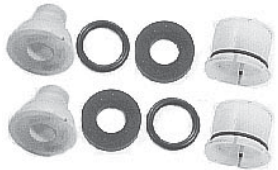

**90042**  
bujes rueda delantera 1.7 Diesel y TurboD  
de 22 estrías, r.o. 326196



**90524**  
bujes rueda trasera (con rodamiento)  
r.o. 1604307

## OPEL ASTRA - F (1992-1998)

 <p><b>4730</b> varilla nivel aceite 1.4-1.6 r.o. 658048</p>	 <p><b>4731</b> varilla nivel aceite 1.7TD (motor Isuzu) r.o. 658028</p>	 <p><b>3682</b> tapón llenado aceite motor 1.4-1.6 r.o. 650094</p>
 <p><b>3684</b> tapón llenado aceite motor 1.4/16v-1.6/16v r.o. 650091</p>	 <p><b>3674</b> tapón llenado aceite motor 1.8-2.0 r.o. 5650831</p>	 <p><b>3683</b> tapón llenado aceite motor 1.7TD (Isuzu) r.o. 650094</p>
 <p><b>4782</b> polea cigueñal 1.7TD (motor Isuzu) r.o. 650091</p>	 <p><b>4720</b> casquillo guía embrague con junta r.o. 668542+668809</p>	 <p><b>4721</b> horquilla embrague r.o. 668198</p>
 <p><b>2489</b> juego casquillos palanca cambio r.o. 758711-736701-758743</p>	 <p><b>5091</b> tensor correa alternador 1.4-1.4/16v-1.6 con aire acondicionado, r.o. 1340544-1340541</p>	 <p><b>5092</b> tensor correa alternador 1.4-1.4/16v-1.6 sin aire acondicionado, r.o. 1206990</p>
 <p><b>4301</b> silentbloc barras cremallera dirección r.o. (no hay despiece)</p>	 <p><b>1773</b> fuelle cremallera asistida "ZF" r.o.</p>	 <p><b>1822</b> fuelle cremallera asistida "SAGINAW" r.o. 1609068</p>
 <p><b>934</b> casquillo tensor alternador 1.4-1.6 r.o. 1204892</p>	 <p><b>810</b> soporte alternador de 70A r.o. 1204580</p>	 <p><b>811</b> soporte tensor alternador todos r.o. 1204885</p>
 <p><b>2492</b> manguito cuerpo de inyección 16v. r.o. 838276</p>	 <p><b>935</b> soporte bomba de gasolina 1.8-2.0 r.o. 817744</p>	 <p><b>2823</b> soporte filtro de aire r.o. 834976</p>

## OPEL ASTRA - F (1992-1998)

 <p><b>1770</b> kit rep. transmisión l/rueda 1.4 r.o.</p>	 <p><b>1770E</b> para montar con cono kit rep. transmisión l/rueda 1.4 r.o.</p>	 <p><b>1490</b> kit rep. transmisión l/cambio 1.7 D r.o.374018</p>
 <p><b>1575</b> kit rep. transmisión l/rueda 1.6-1.8-2.0-D yTD,r.o. 374050</p>	 <p><b>1575E</b> para montar con cono kit rep. transmisión l/rueda 1.6-1.8-2.0-D yTD,r.o. 374050</p>	 <p><b>1730</b> kit rep. transmisión l/cambio 1.4-1.6-1.8 y2.0,r.o. 374019</p>
 <p><b>2619</b> perno longitud 66 mm kit sujeción escape a colector r.o. 854982-854881</p>	 <p><b>2620</b> perno longitud 70 mm kit sujeción escape a colector r.o. 854986-854884</p>	 <p><b>554</b> soporte tubo de escape 4 puertas r.o.852719</p>
 <p><b>058</b> soporte tubo de escape 3 puertas r.o.852722</p>	 <p><b>2393</b> junta cónica tubo escape Ø 46 x 60 mm r.o.560808</p>	 <p><b>2431</b> junta cónica tubo escape Ø 50 x 67 mm r.o.854947</p>
 <p><b>4974</b> tubo filtro aire a caudalímetro 1.4SE-1.6SE r.o. 836772</p>	 <p><b>4975</b> tubo filtro aire a caudalímetro 1.4NZ-1.6NZ- 1.4/16v-1.6/16v-1.8,r.o. 836770</p>	
 <p><b>085</b> soporte tubo de escape r.o. 856700</p>	 <p><b>425</b> cubrepedal freno y embrague r.o.560808</p>	 <p><b>677</b> tapón de cárter 1.4-1.6-1.8-2.0 y D 14x150 tuerca de 19 mm,r.o. 652491</p>
 <p><b>2490</b> tapón de cárter 1.7 TurboD 14x150 tuerca de 22,r.o. 652492</p>	 <p><b>2667</b> tapón de cárter modelo '96 (torx con junta de goma),r.o. 652477</p>	



## OPEL ASTRA-G / ZAFIRA (1998- )

### CANALIZACIONES DE AGUA:

**ASTRA-G/ZAFIRA 1.4/16v motor X14XE  
1.6/16v motor X16XEL**

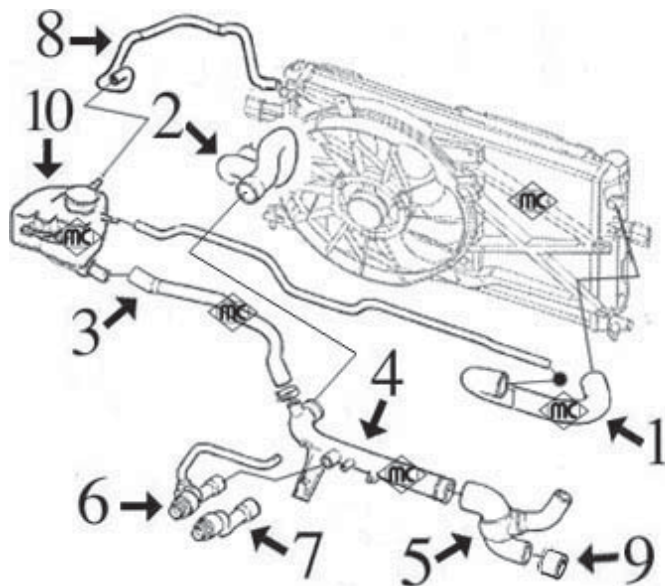

- 1- 8970 mgto superior radiador
- 2- 8971 mgto inferior radiador
- 3- 8992 mgto de tubo rígido a botella expansión
- 4- 3183 tubo de agua rígido
- 5- 8966 mgto de tubo a bomba de agua
- 6- 8983 mgto entrada a calefactor
- 7- 8982 mgto retorno calefactor
- 8- 8995 mgto de botella a radiador
- 9- 3068 boquilla metálica en bloque Ø 30 mm
- 10- 3629 botella de expansión
- 3507 tapón botella de expansión

9056 mgto desvaporizador

**ASTRA-G/ZAFIRA 1.8/16v motor X18XE**

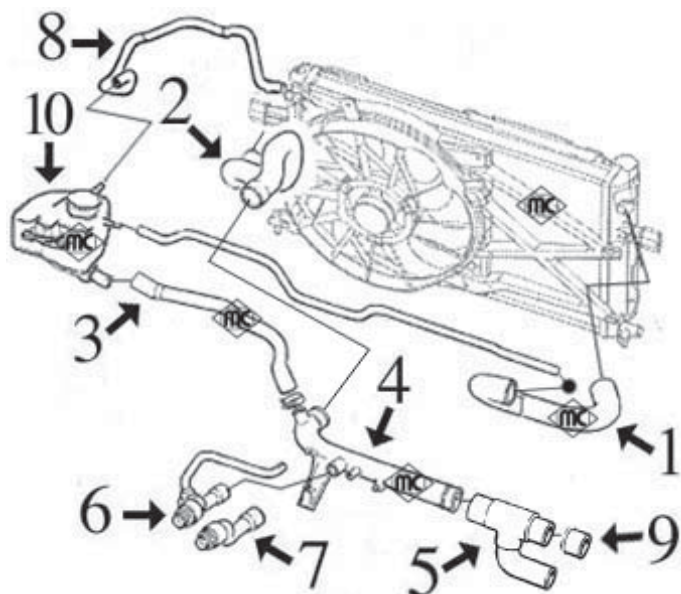

- 1- 8973 mgto superior radiador
- 2- 8977 mgto inferior radiador
- 3- 8992 mgto de tubo rígido a botella expansión
- 4- 3185 tubo de agua rígido
- 5- 8980 mgto de tubo a bomba de agua
- 6- 8984 mgto entrada a calefactor
- 7- 8985 mgto retorno calefactor
- 8- 8995 mgto de botella a radiador
- 9- 3073 boquilla metálica en bloque Ø 34 mm
- 10- 3629 botella de expansión
- 3507 tapón botella de expansión



# OPEL ASTRA-G / ZAFIRA (1998- )

ASTRA-G/ZAFIRA 2.0/16v motor X20XER-XEV

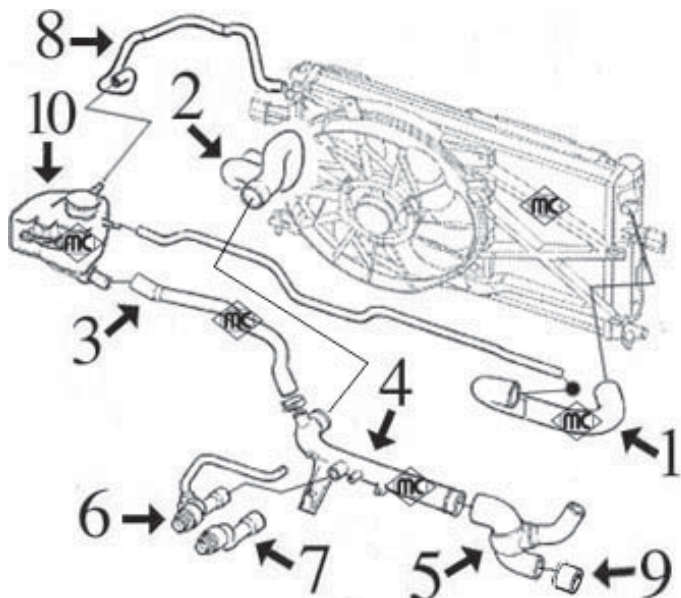

- 1- 8979 mgto superior radiador
- 2- 8978 mgto inferior radiador
- 3- 8992 mgto de tubo rígido a botella expansión
- 4- 3184 tubo de agua rígido
- 5- 8967 mgto de tubo a bomba de agua
- 6- 8986 mgto entrada a calefactor
- 7- 8985 mgto retorno calefactor
- 8- 8995 mgto de botella a radiador
- 9- 3073 boquilla metálica en bloque Ø 34 mm
- 10- 3629 botella de expansión
- 3507 tapón botella de expansión

ASTRA-G/ZAFIRA 1.7DTL motor OPEL X17DTL

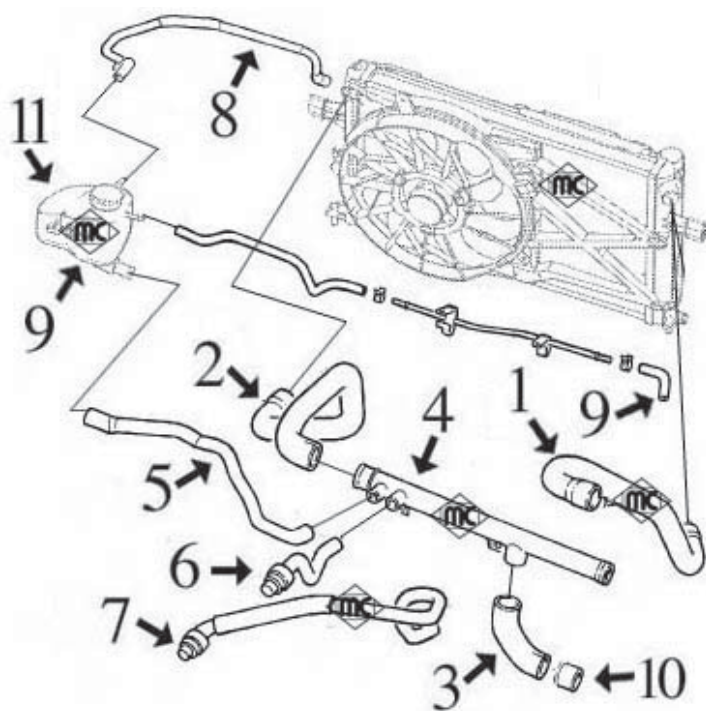

- 1- 8974 mgto superior radiador
- 2- 8964 mgto inferior radiador
- 3- 7323 mgto de tubo rígido a botella expansión
- 4- 3076 tubo de agua de aluminio
- 5- 8993 mgto de tubo a bomba de agua
- 6- 8985 mgto entrada a calefactor
- 7- 8987 mgto retorno calefactor
- 8- 8995 mgto de botella a radiador
- 9- 7998 mgto de tubo metálico a caja entrada
- 10- 3073 boquilla metálica en bloque Ø 34 mm
- 11- 3629 botella de expansión
- 3507 tapón botella de expansión

9057 mgto desvaporizador

ASTRA-G/ZAFIRA 1.7DT motor ISUZU Y17DT

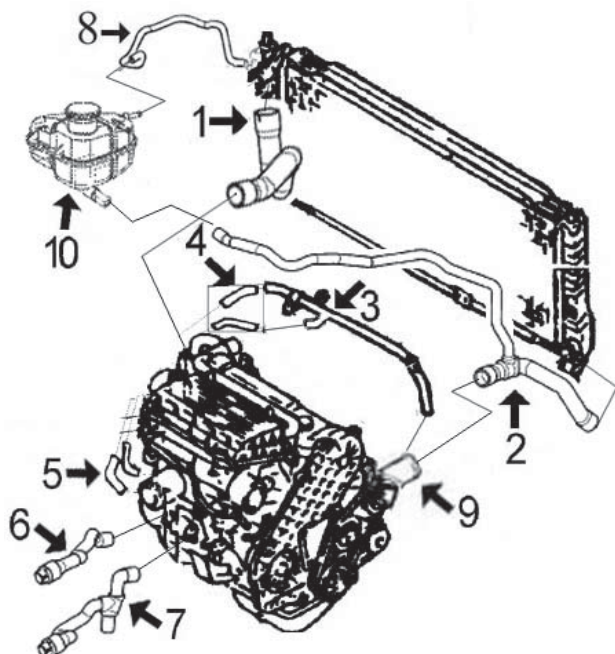

- 1- 8976 mgto superior radiador
- 2- 8975 mgto inferior radiador
- 3- n/d tubo metálico
- 4- 8996 jgo mgto de tubo metálico a caja termostato
- 5- 8115 jgo mgto en intercambiador de aceite
- 6- 8989 mgto entrada a calefactor
- 7- 8988 mgto retorno calefactor
- 8- 8995 mgto de botella a radiador
- 9- 3175 boca de aluminio
- 10- 3629 botella de expansión
- 3507 tapón botella de expansión

8951 mgto desvaporizador

ASTRA-G/ZAFIRA 2.0DTL-DTi motores X20DTL - Y20DTL - Y20DTH  
2.2DTi motor Y22DTR

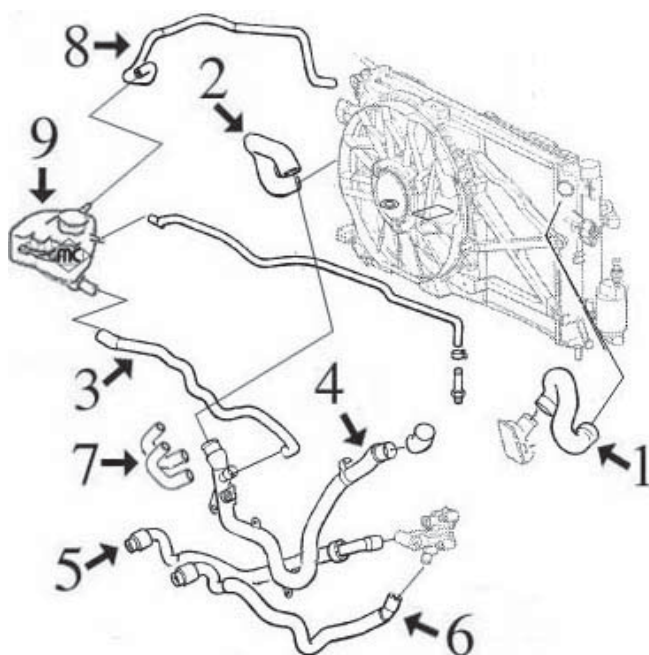

- 1- 8972 mgto superior radiador
- 2- 8981 mgto inferior radiador
- 3- 8994 mgto de tubo rígido a botella
- 4- n/d tubo rígido
- 5- 8990 mgto entrada a calefactor
- 6- 8991 mgto retorno calefactor
- 7- 8997 jgo mgto intercambiador de aceite
- 8- 8995 mgto de botella a radiador
- 9- 3629 botella de expansión
- 3507 tapón botella de expansión

9145 mgto desvaporizador

OPEL ASTRA-G / ZAFIRA (1998- )



**7323**  
mgto bomba de agua 1.7Diesel  
r.o.



**7998**  
mgto de tubo metálico a caja entrada 1.7D  
r.o.



**8115**  
jgo mgto intercambiador 1.7Diesel  
r.o.

**¡Nuevo!**



**8951**  
mgto desvaporizador 1.7DT  
r.o.



**¡Nuevo!**



**8964**  
mgto inferior radiador 1.7DTL  
r.o.

**¡Nuevo!**



**8966**  
mgto de tubo a bomba 1.4/16v-1.6/16v  
r.o.

**¡Nuevo!**



**8967**  
mgto de tubo a bomba 2.0/16v  
r.o.

**¡Nuevo!**



**8970**  
mgto superior radiador 1.4/16v-1.6/16v  
r.o.

**¡Nuevo!**



**8971**  
mgto inferior radiador 1.4/16v-1.6/16v  
r.o.

**¡Nuevo!**



**8972**  
mgto superior radiador 2.0DTL/DTi-2.2DTi  
r.o.

**¡Nuevo!**



**8973**  
mgto superior radiador 1.8-16v  
r.o.

**¡Nuevo!**



**8974**  
mgto superior radiador 1.7DTL  
r.o.

**¡Nuevo!**



**8975**  
mgto inferior radiador 1.7DT  
r.o.

**¡Nuevo!**



**8976**  
mgto superior radiador 1.7DT  
r.o.

**¡Nuevo!**



**8977**  
mgto inferior radiador 1.8/16v  
r.o.

**¡Nuevo!**



**8978**  
mgto inferior radiador 2.0/16v  
r.o.

**¡Nuevo!**



**8979**  
mgto superior radiador 2.0/16v  
r.o.

**¡Nuevo!**



**8980**  
mgto de tubo a bomba 1.8/16v  
r.o.

**¡Nuevo!**



**8981**  
mgto inferior radiador 2.0DT/DTi-2.2DTi  
r.o.

**¡Nuevo!**



















**8982**  
mgto retorno calefactor 1.4/16v-1.6/16v  
r.o.

**¡Nuevo!**



**8983**  
mgto entrada calefactor 1.4/16v-1.6/16v  
r.o.

OPEL ASTRA-G / ZAFIRA (1998- )

<p><b>¡Nuevo!</b></p>  <p><b>8984</b> mgto entrada calefactor 1.8/16v r.o.</p>	<p><b>¡Nuevo!</b></p>  <p><b>8985</b> mgto retorno calefactor 1.8/16v r.o.</p>	<p><b>¡Nuevo!</b></p>  <p><b>8986</b> mgto entrada calefactor 2.0/16v r.o.</p>
<p><b>¡Nuevo!</b></p>  <p><b>8987</b> mgto retorno calefactor 1.7DTL r.o.</p>	<p><b>¡Nuevo!</b></p>  <p><b>8988</b> mgto retorno calefactor 1.7DT r.o.</p>	<p><b>¡Nuevo!</b></p>  <p><b>8989</b> mgto entrada calefactor 1.7DT r.o.</p>
<p><b>¡Nuevo!</b></p>  <p><b>8990</b> mgto entrada calefactor 2.0DTL/DTi-2.2DTi r.o.</p>	<p><b>¡Nuevo!</b></p>  <p><b>8991</b> mgto retorno calefactor 2.0DTL/DTi-2.2DTi r.o.</p>	<p><b>¡Nuevo!</b></p>  <p><b>8992</b> mgto de tubo a botella 1.4-1.6-1.8-2.0 r.o.</p>
<p><b>¡Nuevo!</b></p>  <p><b>8993</b> mgto de tubo a bomba 1.7DTL r.o.</p>	<p><b>¡Nuevo!</b></p>  <p><b>8994</b> mgto de tubo a botella 2.0DTL/DTi-2.2DTi r.o.</p>	<p><b>¡Nuevo!</b></p>  <p><b>8995</b> mgto de botella a radiador todos mods. r.o.</p>
<p><b>¡Nuevo!</b></p>  <p><b>8996</b> jgo mgto de tubo a caja termostato 1.7DT r.o.</p>	<p><b>¡Nuevo!</b></p>  <p><b>8997</b> jgo mgto intercamb. 2.0DTL/DTi-2.2DTi r.o.</p>	<p><b>¡Nuevo!</b></p>  <p><b>9056</b> mgto desvaporizador 1.4/16v-1.6/16v r.o.</p>
<p><b>¡Nuevo!</b></p>  <p><b>9057</b> mgto desvaporizador 1.7DTL r.o.</p>	<p><b>¡Nuevo!</b></p>  <p><b>9145</b> mgto desvaporizador 2.0DTL/DTi-2.2DTi r.o.5656075-5656042</p>	



OPEL ASTRA-G / ZAFIRA (1998- )



**3068**  
boquilla metálica en bloque-bomba de agua  
1.4/16v-1.6/16v, r.o. 606400

Ø 30 mm



**3073**  
boquilla metálica en bloque-bomba de agua  
1.8-2.0y 1.7DTL, r.o. 606401

Ø 34 mm



**3076**  
tubo de agua metálico 1.7 Diesel con juntas  
tóricas, r.o. 1336061



**3175**  
boquilla aluminio en bloque 1.7DT  
r.o. 1336011-6336105

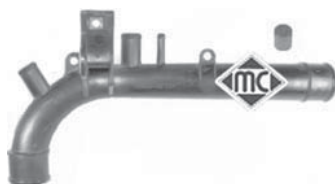

**3183**  
tubo rígido 1.4/16v-1.6/16v  
r.o.



**3184**  
tubo rígido 2.0/16v  
r.o.



**3185**  
tubo rígido 1.8/16v  
r.o.



**3507**  
tapón botella de expansión  
r.o. 1304667



**3629**  
botella de expansión  
r.o.

SUSPENSION DELANTERA y SOPORTES DE MOTOR:

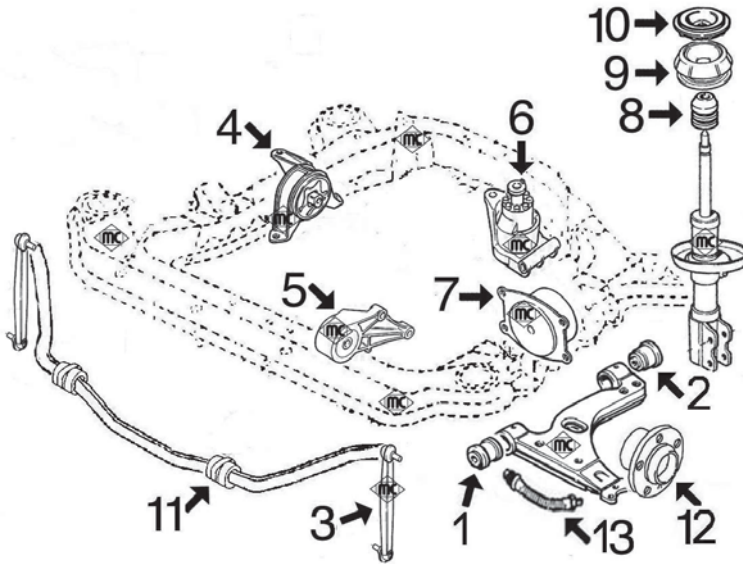

- 1- 4232 silentbloc anterior trapecio delantero
- 2- 4375 silentbloc posterior trapecio delantero
- 3- 4242 bieleta puntal barra estabilizadora (plástico)
- 4- 4378 soporte motor derecho
- 5- 4379 soporte motor delantero 1.2-1.6(8v)-1.7D
- 4380 soporte motor delantero 1.4-1.6(16v)-1.8
- 4381 soporte motor delantero 2.0 D
- 4382 soporte motor delantero 2.0(16v) gasolina
- 6- 4383 soporte motor trasero
- 7- 4393 soporte motor izquierdo 1.2-1.4-1.6-1.8-1.7D
- 4384 soporte motor izquierdo 2.0-2.2-2.0D-2.2D
- 8- n/d tope poliuretano amortiguador delantero
- 9- 4214 soporte amortiguador delantero
- 10- 4313 tapa superior amortiguador con rodamiento
- 11- 4376 goma para barra estabilizadora de Ø 16 mm (1.2)
- 4377 goma para barra estabilizadora de Ø 18 mm (1.4-1.6-1.8-D-TD)
- 12- n/d buje rueda delantera
- 13- 96188 latiguillo freno delantero (396 mm)

SUSPENSION TRASERA:

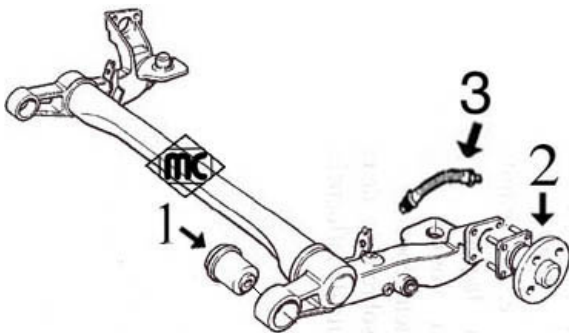

- 1- 4374 silentbloc puente trasero
- 2- 90524 buje rueda trasera, freno sin ABS
- 3- 96138 latiguillo freno trasero (224 mm) 1.2/16v-1.4/16v-1.6/16v-1.7DT-1.7DTi
- 96189 latiguillo freno trasero (224 mm) 1.8/16v-2.0/16v-2.0DTL/DTi-2.2DTi



**4214**  
soporte amortiguador delantero  
r.o. 344523-344525



**4232**  
silentbloc anterior trapecio delantero  
r.o. 3523.57-3523.64



**4242**  
bieleta puntal barra estabilizadora  
r.o. 350611

OPEL ASTRA-G / ZAFIRA (1998- )



**4313**  
tapa con rodamiento amortiguador delantero  
r.o. 344591



**4374**  
silentbloc puente trasero  
r.o. 5402634



**4375**  
silentbloc posterior trapecio delantero  
r.o. 352365

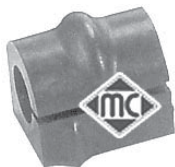

**4376**  
goma para barra estabilizadora de Ø 16 mm  
r.o. 350130



**4377**  
goma para barra estabilizadora de Ø 18 mm  
r.o. 350138



**4378**  
soporte motor derecho  
r.o. 5684051-5684052

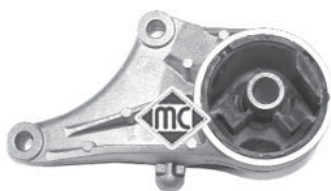

**4379**  
soporte motor delantero 1.2-1.6(8v)-1.7DT-1.7DTL, r.o. 684692

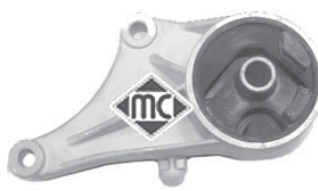

**4380**  
soporte motor delantero 1.4-1.6(16v)-1.8  
r.o. 684694



**4381**  
soporte motor delantero 2.0DT-2.0DTL  
r.o. 684697



**4382**  
soporte motor delantero 2.0(16v) gasolina  
r.o. 684695-5648162

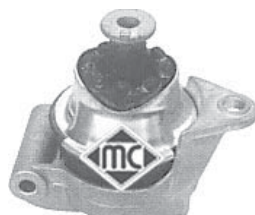

**4383**  
soporte motor trasero  
r.o. 682502-5682509-5682534



**4384**  
soporte motor izquierdo 2.0-2.2-2.0D-2.2D  
r.o. 5684049-5684047-5684048



**4393**  
soporte motor izquierdo 1.2-1.4-1.6-1.8-1.7D  
r.o. 5684045-5684046

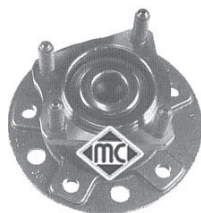

**90524**  
buje rueda trasera sin ABS  
r.o. 1604307-1604004



**96188**  
latiguillo freno delantero (396 mm)  
r.o. 562377

¡Nuevo!



**96138**  
latiguillo freno trasero (224 mm)  
r.o. 5562078



**96189**  
latiguillo freno trasero (224 mm)  
r.o. 5562079

¡Nuevo!



**3710**  
tapón llenado combustible  
r.o. 0808117



**2823**  
soporte filtro de aire  
r.o. 834976

¡Nuevo!



**4969**  
juego casquillos palanca de cambio  
r.o.

OPEL ASTRA-G / ZAFIRA (1998- )



**3629**  
botella expansión  
r.o. 1304223



**3507**  
tapón botella de expansión  
r.o. 1304667

**¡Nuevo!**



**4718**  
polea cigüeñal 2.0 gasolina  
r.o. 615029

**¡Nuevo!**



**4856**  
polea cigüeñal 1.7DT-DTL hasta '03  
r.o. 5614441

**¡Nuevo!**



**4857**  
polea cigüeñal 1.7DT-DTL desde '03-  
r.o. 5614444

**¡Nuevo!**

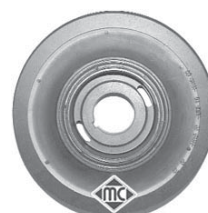

**4491**  
polea cigüeñal 2.0DTI/DTi-2.2DTi  
r.o. 5614437

**¡Nuevo!**



**3682**  
tapón llenado aceite motor 1.6  
r.o. 650094

**¡Nuevo!**



**3674**  
tapón llenado aceite motor 1.6/16v-2.0/16v-  
1.7DTL-2.0DTL-2.2DTL, r.o. 5650831

**¡Nuevo!**



**4730**  
varilla nivel aceite 1.4/16v-1.6/16v-1.8/16v  
r.o. 658048

**¡Nuevo!**



**4697**  
varilla nivel aceite 1.7DT hasta '03  
r.o. 658054

**¡Nuevo!**



**4773**  
rodillo tensor correa alternador  
r.o. 1340514  $\text{Ø } 65 \text{ mm}$

**¡Nuevo!**

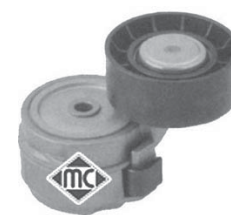

**5090**  
tensor correa alternador 2.0/16v  
r.o. 1340544-1340541



**1107**  
fuelle cremallera dirección  
r.o.



**1112**  
kit fuelle transm. l/rueda 1.2  
r.o.



**1989**  
kit fuelle transm. l/rueda 1.4-1.6  
r.o. 374002



**1175**  
kit fuelle transm. l/rueda 1.8-2.0-1.7DT-DTL-  
2.0DTL, r.o.



**1490**  
kit fuelle transm. l/cambio 1.2-1.4-1.6-1.7DTL  
r.o. 374018



**1114**  
kit fuelle transm. l/cambio 1.8-2.0-2.0DTL  
r.o.



**2428**  
soporte tubo de escape  
r.o. 852726



**2667**  
tapón cárter aceite todos mods. salvo 1.7DT  
r.o. 652477



**2490**  
tapón cárter de aceite 1.7DT  
r.o. 652492



CANALIZACIONES DE AGUA

CORSA-A 1.0 :

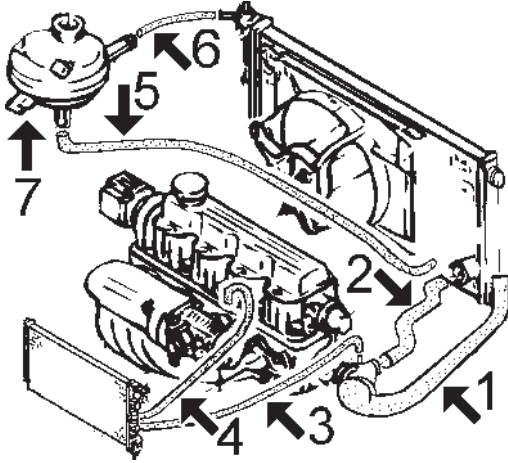

- 1- 7529 mgtto superior radiador
- 2- 7528 mgtto inferior radiador hasta '89  
7765 mgtto inferior radiador desde '89
- 3- 7370 mgtto de calefactor a bomba de agua
- 4- 7371 mgtto de calefactor a culata
- 5- 8179 mgtto inferior de botella a radiador
- 6- 754 mgtto sobrante de botella a radiador: Cortar de rolo MC-754 Ø 12x19 mm (trenzado exterior), longitud aproximada 400 mm
- 7- 3502 botella de expansión  
3507 tapón botella expansión

8251 mgtto desvaporizador

CORSA-A 1.2 - 1.3 - 1.4 :

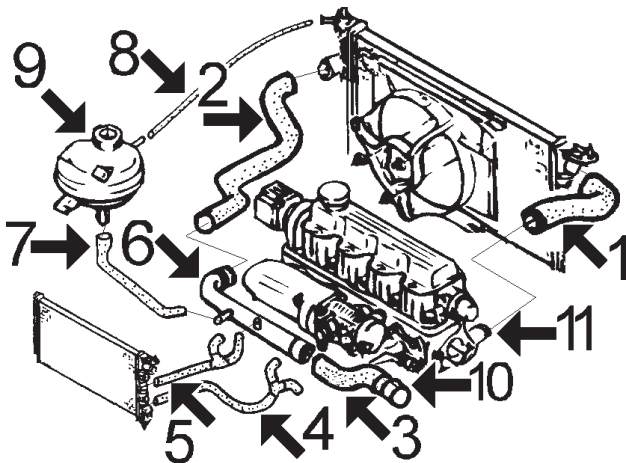

- 1- 7324 mgtto superior radiador, Ø bocas desiguales, 1.2-1.3 y 1.4 carburador  
7534 mgtto superior radiador, Ø bocas iguales 1.2-1.3  
8136 mgtto superior radiador 1.4 inyección
- 2- 7535 mgtto inferior radiador
- 3- 7406 mgtto de tubo a bomba de agua 1.2-1.3-1.4 carb.  
8244 mgtto de tubo a bomba de agua 1.4 inyección
- 4- 7795 mgtto de calefactor a colector de admisión 1.2  
n/d mgtto de calefactor a colector y carburador 1.3 y 1.4 carburador  
7663 mgtto de calefactor a colector 1.4 inyección
- 5- 7797 mgtto de calefactor a tubo metálico 1.2  
n/d mgtto de calefactor a tubo metálico y carb. 1.3 y 1.4 carburador  
7662 mgtto de calefactor a tubo metálico 1.4 inyección
- 6- 3018 tubo de agua metálico
- 7- 7988 mgtto de botella a tubo metálico
- 8- 754 mgtto de sobrante de botella a radiador: Cortar de rolo MC-754 Ø 12x19 mm, long. 400 mm
- 9- 3502 botella de expansión  
3507 tapón botella de expansión (1.2 bar)
- 10- 3068 boquilla metálica en bloque - bomba de agua
- 11- 3071 tapa de termostato (aluminio)

8252 mgtto desvaporizador  
8254 mgtto desvaporizador

CORSA-A 1.6 GSI:

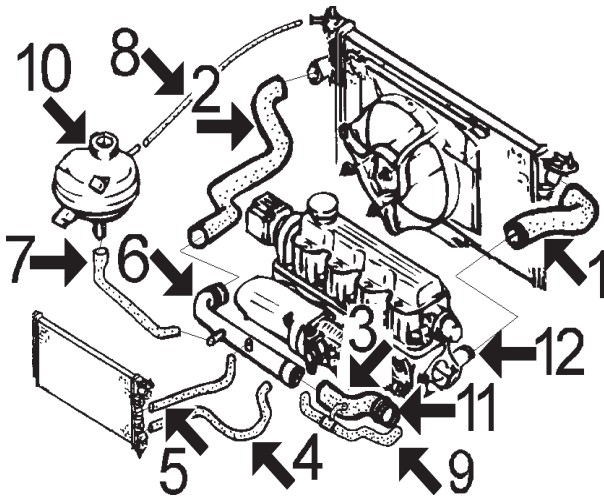

- 1- 8136 mgto superior de radiador
- 2- 7407 mgto inferior de radiador
- 3- 7406 mgto de tubo rígido a bomba de agua
- 4- n/d mgto de calefactor a colector de admisión
- 5- 7663 mgto de calefactor a tubo rígido
- 6- 3179 tubo rígido
- 7- 7988 mgto de botella a tubo rígido
- 8- 754 mgto de sobrante de botella a radiador: Cortar de rollo MC-754 Ø 12x19 mm, long. 400 mm
- 9- n/d mgto de colector de admisión a bomba de agua y a calentador entrada de aire (3 vias)
- 10- 3502 botella de expansión  
3507 tapón botella de expansión (1.2 bar)
- 11- 3068 boquilla metálica en bloque - bomba de agua
- 12- 3071 tapa de termostato (aluminio)

n/d = no disponible

CORSA-A 1.5 Diesel y 1.5 TurboD

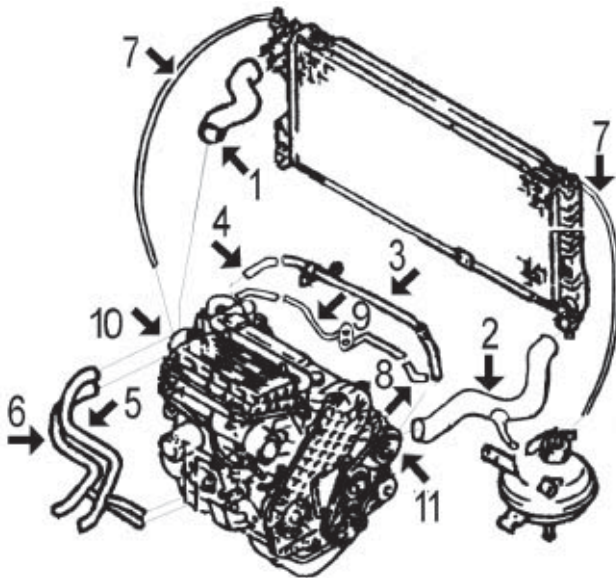

- 1- 8241 mgto superior de radiador
- 2- 8242 mgto inferior de radiador
- 3- 3163 tubo de agua metálico 1.5D  
3160 tubo de agua metálico 1.5TD
- 4- 8033 mgto de tubo metálico a caja termostato 1.5D  
8115 jgo mgto de caja termostato a tubo metálico 1.5TD
- 5- 8264 mgto derecho de calefactor
- 6- 8263 mgto izquierdo de calefactor
- 7- 754 mgto de sobrante de botella a caja de termostato, cortar de rollo ref. MC-754 (Ø 12 x 19 mm)
- 8- 8033 mgto enlace tubos metálicos 1.5TD
- 9- 3164 tubo de agua metálico con junta 1.5TD
- 10- 3162 caja de termostato  
4714 caja de termostato  
4715 caja de termostato
- 11- 4693 boca de aluminio conexión mgto.

## OPEL CORSA - A (1983-1993)



**7324**

mgto superior radiador 1.2 - 1.3 - 1.4, bocas desiguales de Ø 32 y 38 mm, r.o. 1336431



**7370**

mgto de calefactor a bomba de agua 1.0 r.o. 1818522



**7371**

mgto de calefactor a culata 1.0 r.o. 1818524



**7406**

bocas Ø 30-35 mm

mgto de tubo rígido a bomba de agua 1.2, 1.3 y 1.4 (carburador), r.o. 1336291



**7407**

mgto inferior radiador 1.6 GSI r.o. 1336505



**7528**

mgto inferior radiador 1.0 hasta '89 r.o. 1336384



**7529**

mgto superior radiador 1.0 r.o. 1336319



**7534**

mgto superior radiador 1.2-1.3 bocas iguales de Ø 32 mm r.o. 1336320 - 1336325



**7535**

mgto inferior radiador 1.2 - 1.3 - 1.4 r.o. 1336323 - 1336410



**7662**

mgto de calefactor a tubo rígido 1.4 i r.o. 1818344 - 1818330



**7663**

mgto de calefactor a colector de adm. 1.4 i r.o. 1818345



**7765**

mgto inferior radiador 1.0 desde '89 r.o. 1336745



**7795**

mgto de calefactor a colector de adm. 1.2 r.o. 1818523



**7797**

mgto de calefactor a tubo rígido 1.2 r.o. 1818521



**7988**

mgto de botella a tubo 1.2-1.3-1.4-1.6 r.o. 1336381



**8033**

mgto de caja termostato a tubo rígido 1.5 Diesel, r.o. 1336461



**8115**

jgo mgto de tubos metálicos a caja termostato 1.5TD, r.o.



**8136**

mgto superior radiador 1.6 GSI - 1.4 i r.o. 1336464



**8179**

mgto inferior de botella a radiador 1.0 r.o. 1336385



**8241**

mgto superior radiador 1.5 Diesel r.o. 1336466



**8242**

mgto inferior radiador 1.5 Diesel r.o. 1336467

## OPEL CORSA - A (1983-1993)



**8244** bocas Ø 30-39 mm  
mgto de tubo rígido a bomba de agua  
1.4 inyección y 1.6 GSI, r.o. 1337095



**8254**  
mgto desvaporizador 1.2-1.3-1.4  
r.o. 656234



**8263**  
mgto izquierdo de calefactor 1.5 D-TD  
r.o. 6818302



**8264**  
mgto derecho calefactor 1.5 D-TD  
r.o. 6818301



**3018**  
tubo metálico 1.2-1.3-1.4  
r.o. 1336713

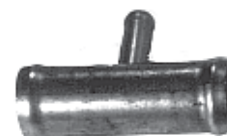

**3046**  
racor enlace manguitos de calefacción  
1.3 y 1.4 (carburador), r.o.



**3068**  
boquilla entrada agua a bloque 1.2-1.3-1.4  
y 1.6, r.o. 606400



**3160**  
tubo de agua metálico 1.5TD  
r.o. 1336067



**3164**  
tubo de agua metálico 1.5TD con junta  
r.o. 1336065



**3162**  
caja de termostato 1.5D-1.5TD  
r.o. 1338182

**¡Nuevo!**

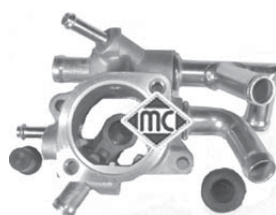

**4715**  
caja de termostato 1.5D-TD  
r.o. 1338191-1338194-1338192



**3163**  
tubo de agua metálico 1.5D  
r.o. 1336069

**¡Nuevo!**

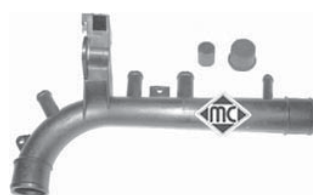

**3179**  
tubo de agua 1.6GSI  
r.o.

**¡Nuevo!**



**4693**  
boca aluminio conexión manguito 1.5D-TD  
r.o. 606406



**3502**  
botella de expansión  
r.o. 1304618



**3507**  
tapón botella de expansión (1,20 bar)  
r.o. 1304667



**3071**  
tapa de termostato 1.2-1.3-1.4-1.6  
r.o. 1338151



**2356** Ø 41 x 48 mm  
junta de termostato  
r.o.



**2357** Ø 46 x 55 mm  
junta de termostato  
r.o.



**2492**  
mgto unión cuerpo de inyección 1.4i - 1.6i  
r.o. 838276



SUSPENSION DELANTERA y SOPORTES DE MOTOR

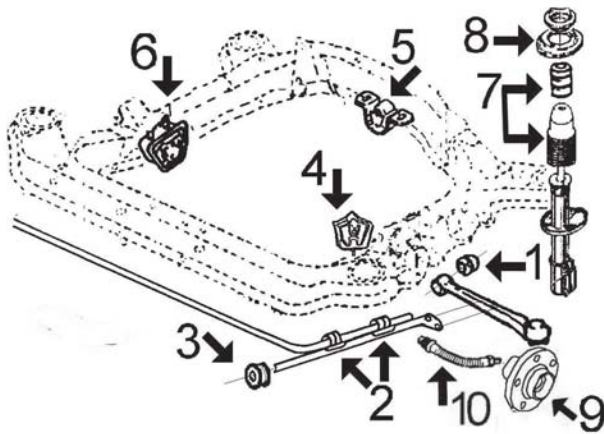

- 1- 547 silentbloc brazo de suspensión
- 2- 855 goma barra estabilizadora Ø 17 mm
- 863 goma barra estabilizadora Ø 19 mm
- 3- 491 silentbloc tirante brazo de suspensión
- 4- 518 soporte de motor izquierdo todos mods.
- 5- 744 soporte de motor trasero todos mods.
- 6- 725-C soporte de motor derecho (excepto 1.5 Diesel)
- 2615 soporte de motor derecho 1.5 Diesel y TD
- 7- 4710 juego tope poliuretano y capuchón amortiguador
- 8- 2498 soporte de amortiguador
- 4350 tapa amortiguador superior con rodamiento
- 9- 90004 buje de rueda delantera
- 10- 96158 latiguillo freno delantero

 <p><b>491</b> silentbloc tirante brazo suspensión delantero r.o. 353560</p>	 <p><b>547</b> silentbloc brazo suspensión delantero r.o. 352327</p>	 <p><b>492</b> silentbloc puente trasero r.o. 402641</p>
<p><b>4710</b> juego tope poliuretano y capuchón amortiguador delantero, r.o. 344444 - 344182</p> 	<p><b>90004</b> bujes de rueda delantera r.o. 332197</p> 	<p><b>2498</b> soporte amortiguador delantero r.o. 344507 - 344522</p> 
<p><b>855</b> goma barra estabilizadora Ø 17 mm r.o. 350109</p> 	<p><b>863</b> goma barra estabilizadora Ø 19 mm r.o. 350119 - 350127</p> 	<p><b>518</b> soporte de motor izquierdo todos r.o. 684262</p> 
<p><b>725-C</b> soporte de motor derecho (gasolina) r.o. 684195</p> 	<p><b>744</b> soporte de motor trasero todos r.o. 682552</p> 	<p><b>2615</b> soporte de motor derecho Diesel y TD r.o. 684281</p> 
<p><b>4350</b> tapa superior amortiguador delantero con rodamiento, r.o. 312503</p> 	<p><b>96158</b> latiguillo freno delantero (310 mm) r.o. 562345</p> 	<p><b>96159</b> latiguillo freno trasero (195 mm) r.o. 562346</p> 

## OPEL CORSA - A (1983-1993)



**811**  
soporte alternador  
r.o. 1204885



**934**  
casquillo tensor alternador  
r.o. 1204892 - 1204969

**¡Nuevo!**



**4782**  
polea cigueñal 1.5D-TD  
r.o. 5614417



**2414**  
bieleta cambio de velocidades  
r.o. 0758800-075882



**2489**  
juego casquillos palanca de cambio  
r.o. 758711 - 736701 - 758223



**338**  
fuelle cremallera dirección  
r.o. 902827



**1343E cono**      **1343 normal**  
kit rep. transmisión l/rueda  
(neopreno especial de elasticidad 800%)



**1344**  
kit rep. transmisión l/cambio (salvo 1.6)  
r.o. 374093



**1490**  
kit rep. transmisión l/cambio 1.6 GSI-1.5D  
r.o. 374018

**¡Nuevo!**



**4731**  
varilla nivel aceite 1.5D-TD  
r.o. 658028

**¡Nuevo!**



**3682**  
tapón llenado aceite 1.2-1.4-1.6  
r.o. 650094

**¡Nuevo!**



**3683**  
tapón llenado aceite motor 1.5D-TD  
r.o. 650089



**2619**  
kit sujeción escape a colector  
(long. tornillo 66 mm), r.o. 854982-854881



**2393**  
junta cónica tubo de escape Ø 46 x 60 mm  
r.o. 854931 - 854932



**2450**  
junta cónica tubo de escape Ø 42 x 57 mm  
r.o. 854934 - 854945



**085**  
silentbloc tirante escape 1.3-1.4  
r.o. 856700



**270**  
soporte tubo de escape  
r.o. 852720



**553**  
soporte silenciador trasero hasta '93  
r.o. 856519



**2490**  
tapón cárter de aceite 1.5 Diesel y TD  
r.o. 652492



**677**  
tapón cárter de aceite (gasolina)  
r.o. 652491 - 652475



**425**  
cubrepedal freno y embrague  
r.o. 560808

CANALIZACIONES DE AGUA

CORSA 1.2 - 1.4 (motores SZ, NZ y SE de 8 válvulas):

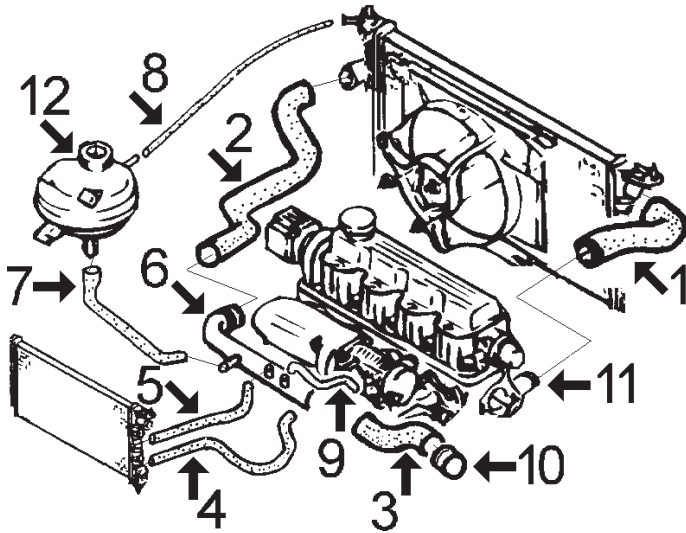

- 1- 8239 mgto superior radiador sin aire acondicionado
- 8240 mgto superior radiador con aire acondicionado
- 2- 8234 mgto inferior radiador
- 3- 8244 mgto de tubo rígido a bomba de agua
- 4- 8261 mgto de calefactor a colector de admisión
- 5- 8262 mgto de calefactor a tubo rígido
- 6- 3179 tubo de agua rígido (plástico)
- 7- 8245 mgto de botella a tubo rígido
- 8- 8232 mgto sobrante de botella a radiador
- 9- 8250 mgto de tubo rígido a colector admisión 1.4
- 10- 3068 boquilla metálica entrada agua a bomba
- 11- 3071 tapa de termostato (aluminio)
- 12- 3515 botella de expansión
- 3507 tapón botella de expansión 1,20 bar
  
- 8253 mgto. desvaporizador de gases
- 8254 mgto. desvaporizador de gases

CORSA 1.4-16v y 1.6-16v (motores X14XE y X16XE de 16 válvulas):

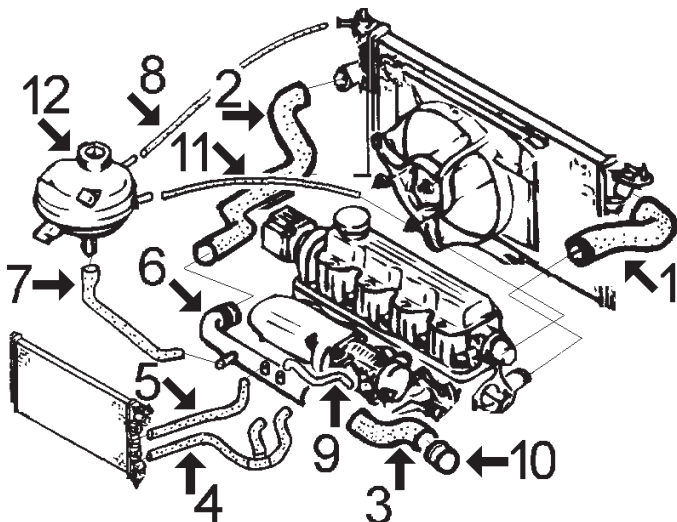

- 1- 8233 mgto superior radiador sin aire acondicionado
- 8243 mgto superior radiador con aire acondicionado
- 2- 8234 mgto inferior radiador
- 3- 8244 mgto de tubo rígido a bomba de agua
- 4- 8249 mgto de calefactor a colector de admisión
- 5- 8071 mgto de calefactor a tubo rígido
- 6- 3182 tubo de agua rígido (plástico)
- 7- 8246 mgto de botella a tubo rígido, motor 1.4
- 8247 mgto de botella a tubo rígido, motor 1.6
- 8- n/d mgto de sobrante de botella, motor 1.6
- 9- 8248 mgto de tubo rígido a colector
- 10- 3068 boquilla metálica entrada agua a bomba
- 11- n/d mgto de sobrante de botella a tapa de termostato
- 12- 3515 botella de expansión
- 3507 tapón botella de expansión 1,20 bar



CORSA 1.0-12v y 1.2-12v (motores de 3 cilindros X10XE Y X12XE):

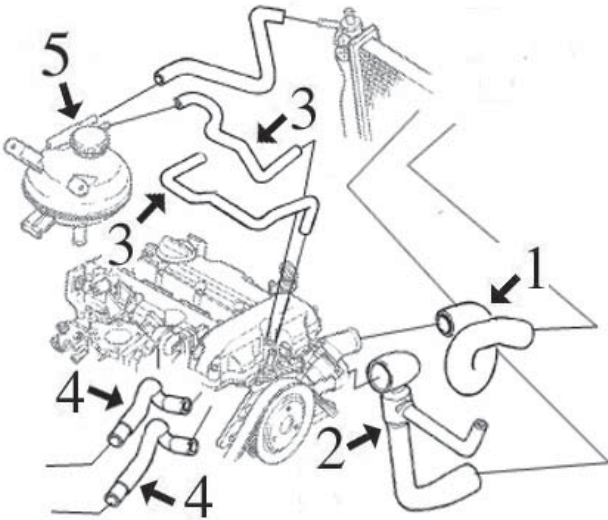

- 1- 8955 mgto superior radiador 1.0/12v sin aire acond.
- 8923 mgto superior radiador 1.0/12v con aire acond.
- 8958 mgto superior radiador 1.2/12v
- 2- 8957 mgto inferior radiador 1.0/12v sin aire acond.
- 8956 mgto inferior radiador 1.0/12v sin aire acond.
- 8959 mgto inferior radiador 1.2/12v
- 3- 8960 jgo mgto de cuerpo ralenti a botella y a cuerpo de termostato 1.0/12v y 1.2/12v
- 4- 8962 jgo mgto entrada-salida calefactor 1.0/12v
- 8961 jgo mgto entrada-salida calefactor 1.0/12v
- 5- 3515 botella de expansión
- 3507 tapón botella de expansión

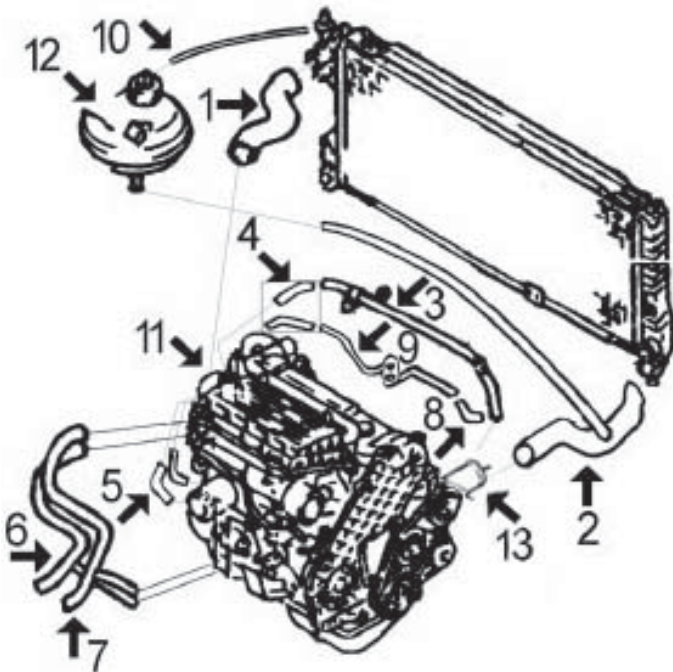

CORSA 1.5 Diesel, 1.5 TurboDiesel y 1.7 Diesel:























- 1- 8259 mgto superior radiador
- 2- 8260 mgto inferior radiador
- 3- 3163 tubo de agua metálico 1.5D hasta '95
- 3069 tubo de agua metálico 1.5D desde '95
- 3160 tubo de agua metálico 1.5TD hasta '95
- 3127 tubo de agua metálico 1.5TD desde '95 hasta '97
- 3069 tubo de agua metálico 1.5TD desde '97
- 3069 tubo de agua metálico 1.7D hasta '98
- 3163 tubo de agua metálico 1.7D desde '98
- 4- 8115 juego mgto de caja termostato a tubo metálico
- 5- 8196 juego mgto intercambiador filtro de aceite, 1.5TD y 1.7D
- 6- 8263 mgto izquierdo de calefactor todos
- 7- 8264 mgto derecho de calefactor todos
- 8- 8033 mgto unión tubos metálicos 1.5 TD
- 9- 3164 tubo de agua metálico a Turbo 1.5TD con junta
- 10- 754 mgto sobrante de botella a radiador. Cortar de rollo MC-754 Ø 12 x 19 mm, long. 55 cms.
- 11- 4714 caja de termostato 1.5D y 1.7D hasta '98
- 4715 caja de termostato 1.5TD y 1.7D desde '98
- 12- 3515 botella de expansión
- 3507 tapón botella de expansión 1,20 bar
- 13- 4693 boca aluminio conexión mgto superior hasta '98
- 4713 boca aluminio conexión mgto superior desde '98





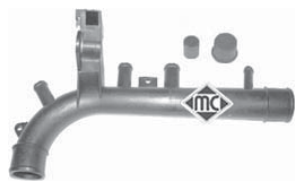

## OPEL CORSA - B (1993-2001)

 <p><b>8033</b> mgto unión tubos metálicos 1.5 TD - 1.7 TD r.o.1336461</p>	 <p><b>8071</b> mgto de calefactor a tubo rígido 1.4-16v y 1.6-16v,r.o.1818255</p>	 <p><b>8115</b> jgo mgto de caja termostato a tubo metálico, Diesel y TD, r.o. 1336503 - 1336065</p>
 <p><b>8196</b> jgo mgto intercambiador 1.5 TD, 1.7 D y 1.7 TD, r.o. 650872-650873</p>	 <p><b>8232</b> mgto de sobrante de botella 1.2 - 1.4 r.o. 1337197</p>	 <p><b>8233</b> mgto sup radiador 1.4-16v y 1.6-16v sin aire ac., r.o. 1337190</p>
 <p><b>8234</b> mgto inferior radiador todos mods. r.o. 1337193-1337193</p>	 <p><b>8239</b> mgto sup radiador 1.2 - 1.4 sin aire acond. r.o. 1337186</p>	 <p><b>8240</b> mgto sup radiador 1.2-1.4 con aire acond. r.o. 1337188</p>
 <p><b>8243</b> mgto sup radiador 1.4-16v y 1.6-16v con aire acondicionado, r.o. 1337191</p>	 <p><b>8244</b> bocas Ø 30-39 mm mgto de tubo rígido a bomba de agua, 1.4-16v. y 1.6-16v., r.o. 1337095</p>	 <p><b>8245</b> mgto de botella a tubo rígido 1.2-1.4 r.o. 1818256</p>
 <p><b>8246</b> mgto de botella a tubo rígido 1.4-16v r.o. 6818182</p>	 <p><b>8248</b> mgto de tubo rígido a colector, 1.4-16v. y 1.6-16v., r.o. 1818563</p>	 <p><b>8249</b> mgto de calefactor a colector de admisión, 1.4-16v./1.6-16v., r.o. 1818254</p>
 <p><b>8250</b> mgto de tubo rígido a colector de admisión, 1.4,r.o. 1337383</p>	 <p><b>8253</b> mgto desvaporizador 1.2-1.4 r.o. 5656065</p>	 <p><b>8254</b> mgto desvaporizador, 1.2-1.4 r.o. 656234</p>
 <p><b>8259</b> mgto superior radiador Diesel y TurboD r.o. 1337381</p>	 <p><b>8260</b> mgto inferior radiador Diesel y TurboD r.o. 1337380</p>	 <p><b>8261</b> mgto de calefactor a colector admisión 1.2-1.4,r.o. 1818243</p>

## OPEL CORSA - B (1993-2001)

 <p><b>8262</b> mgto de calefactor a tubo rígido 1.2-1.4 r.o. 1818564</p>	 <p><b>8263</b> mgto izquierdo de calefactor Diesel y TD r.o. 6818302</p>	 <p><b>8264</b> mgto derecho calefactor Diesel y TD r.o. 6818301</p>
<p><i>¡Nuevo!</i></p>  <p><b>8923</b> mgto superior radiador 1.0/12v aire acond. r.o.</p>	<p><i>¡Nuevo!</i></p>  <p><b>8955</b> mgto superior radiador 1.0/12v sin aire ac. r.o.</p>	<p><i>¡Nuevo!</i></p>  <p><b>8956</b> mgto inferior radiador 1.0/12v aire acond. r.o.</p>
<p><i>¡Nuevo!</i></p>  <p><b>8957</b> mgto inferior radiador 1.0/12v sin aire acond. r.o.</p>	<p><i>¡Nuevo!</i></p>  <p><b>8958</b> mgto superior radiador 1.2/12v r.o.</p>	<p><i>¡Nuevo!</i></p>  <p><b>8959</b> mgto inferior radiador 1.2/12v r.o.</p>
<p><i>¡Nuevo!</i></p>  <p><b>8960</b> jgo mgto de cuerpo ralenti a botella y cuerpo de termostato 1.0/12v-1.2/12v, r.o.</p>	<p><i>¡Nuevo!</i></p>  <p><b>8961</b> jgo mgto entrada/salida calefactor 1.2/12v r.o.</p>	<p><i>¡Nuevo!</i></p>  <p><b>8962</b> jgo mgto entrada/salida calefactor 1.0/12v r.o.</p>
 <p><b>2356</b> junta de termostato Ø 41x48 mm r.o.</p>	 <p><b>3068</b> boquilla metálica entrada agua a bomba todos (salvo D-TD), r.o. 606400</p>	 <p><b>3071</b> tapa de termostato 1.2-1.4 r.o. 1338151</p>
 <p><b>3069</b> tubo de agua metálico 1.5D-1.5TD-1.7D r.o. 1336122 (reemplaza a 1337235)</p>	 <p><b>3127</b> tubo de agua metálico 1.5TD r.o. 1337232</p>	 <p><b>3160</b> tubo de agua metálico 1.5TD r.o. 1336067</p>
 <p><b>3164</b> tubo de agua metálico a Turbo 1.5TD con junta, r.o. 1336065</p>	 <p><b>3163</b> tubo de agua metálico 1.7D desde '98 r.o. 1336069</p>	<p><i>¡Nuevo!</i></p>  <p><b>3179</b> tubo de agua rígido 1.2/8v-1.4/8v r.o.</p>

## OPEL CORSA - B (1993-2001)

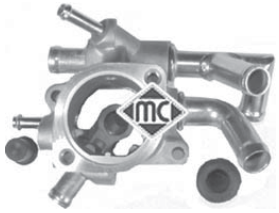
<p><b>¡Nuevo!</b></p>  <p><b>3182</b> tubo de agua rígido 1.4/16v-1.6/16v r.o.</p>	 <p><b>3507</b> tapón botella expansión r.o. 1304667</p>	 <p><b>3515</b> botella de expansión gasolina y diésel r.o. 1304648(1304643)</p>
<p><b>¡Nuevo!</b></p>  <p><b>4693</b> boca aluminio conexión mgto sup. 1.5D/TD- 1.7D hasta '98, r.o. 606406</p>	<p><b>¡Nuevo!</b></p>  <p><b>4713</b> boca aluminio conexión mgto sup. 1.5D/TD- 1.7D desde '98, r.o. 1338323</p>	<p><b>¡Nuevo!</b></p>  <p><b>4715</b> caja de termostato 1.5D-1.7D/TD r.o. 1338191-1338194-1338192</p>

SUSPENSION DELANTERA y SOPORTES DE MOTOR

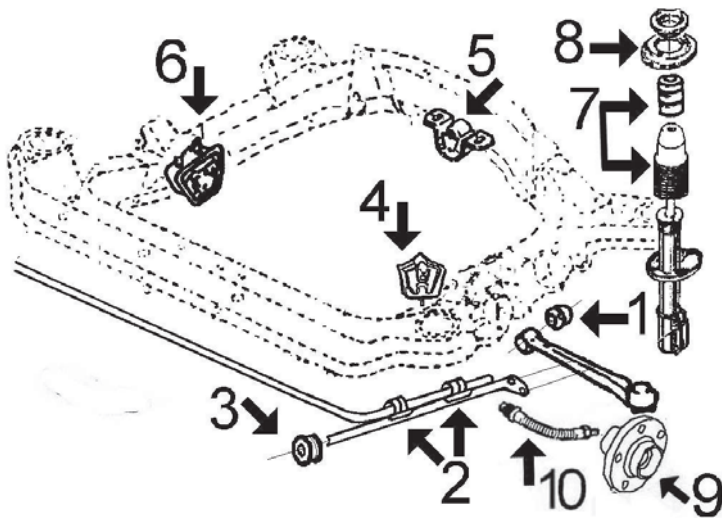

- 1- 2493 silentbloc brazo delantero
- 2- 863 goma barra estabilizadora
- 3- 2613 silentbloc tirante brazo delantero
- 4- 2495 soporte motor izquierdo 1.4 con servodirección, 1.4-16v, 1.6-16v, 1.0/12v y 1.2/12v
- 2497 soporte motor izquierdo 1.2 - 1.4 sin servodirección - Diesel y TurboD
- 5- 4170 soporte motor trasero todos tipos
- 6- 2494 soporte motor derecho 1.0/12v - 1.4 con servodirección - 1.4 16v, 1.6 16v y 1.2/12v
- 2496 soporte motor dcho. 1.2 y 1.4 sin servodirección
- 2614 soporte motor derecho Diesel y TurboD
- 7- 4710 juego tope de poliuretano y capuchón amortiguador delantero
- 8- 2499 soporte amortiguador delantero
- 4350 tapa superior con rodamiento
- 9- 90004 buje de rueda delantera
- 10- 96089 latiguillo freno delantero (340 mm)



**2493**  
silentbloc brazo delantero  
r.o.352301



**2613**  
silentbloc tirante brazo delantero  
r.o.353561



**863**  
goma barra estabilizadora  
r.o.350127



**2494**  
soporte motor derecho motores 16v  
r.o.684666



**2495**  
soporte motor izquierdo motores 16v  
r.o.684671-684665-684661



**2496**  
soporte motor derecho 1.2-1.4 salvo 16v  
r.o.684294



**2497**  
soporte motor izquierdo 1.2-1.4 Diesel y TD  
r.o.684669-684126-684659



**2614**  
soporte motor derecho Diesel y TurboD  
r.o.684160



**4170**  
soporte motor trasero  
r.o.682603



**2499**  
soporte amortiguador delantero  
r.o.344519

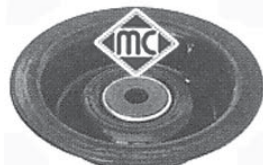

**4350**  
tapa con rodamiento amortiguador delt.  
r.o. 312503





















**¡Nuevo!**



**4710**  
juego tope poliuretano y capuchón amortiguador delantero, r.o. 344405 - 344182

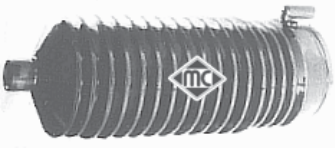

OPEL CORSA - B (1993-2001)

 <p><b>492</b> silentbloc brazo suspensión trasera r.o. 402641</p>	 <p><b>2491</b> goma ballesta trasera COMBO r.o. 430051</p>	
 <p><b>90004</b> buje rueda delantera r.o. 332197</p>	 <p><b>96089</b> latiguillo freno delantero (340 mm) r.o. 562095</p>	 <p><b>96159</b> latiguillo freno trasero (195 mm) r.o. 562346</p>
 <p><b>2489</b> juego casquillos palanca de cambio r.o. 758711-736701-758743</p>	 <p><b>2414</b> bioleta cambio de velocidades r.o. 758800</p>	 <p><b>4720</b> casquillo guía embrague con junta r.o. 668542-668809</p>
 <p><b>4721</b> horquilla embrague r.o. 668198</p>	 <p><b>4782</b> polea cigüeñal 1.5D/TD-1.7D r.o. 5614417-614637</p>	 <p><b>2492</b> manguito conexión cuerpo inyección 1.4/16v-1.6/16v, r.o. 838276</p>
 <p><b>5091</b> tensor correa alternador 1.4-1.4/16v-1.6 con aire acondicionado, r.o. 1340544-1340541</p>	 <p><b>5092</b> tensor correa alternador 1.4-1.4/16v-1.6 sin aire acondicionado, r.o. 1206990</p>	 <p><b>4773</b> <span style="float: right;">Ø 65 mm</span> rodillo tensor correa alternador 1.2/12v, 1.4 y 1.6, r.o. 1340514</p>
 <p><b>1338</b> fuelle cremallera manual r.o. 902826</p>	 <p><b>1191</b> fuelle cremallera asistida r.o. 1609087</p>	 <p><b>4973</b> tubo toma de aire a filtro 1.4 r.o. 836793</p>
 <p><b>1989</b> kit rep. transmisión lado rueda r.o. 374102</p>	 <p><b>1344</b> kit rep. transmisión lado cambio r.o. 374093</p>	

## OPEL CORSA - B (1993-2001)

<p><b>¡Nuevo!</b></p>  <p><b>4730</b> varilla nivel aceite 1.2-1.4 r.o. 658048</p>	<p><b>¡Nuevo!</b></p>  <p><b>4731</b> varilla nivel aceite 1.5D-TD-1.7D r.o. 658028</p>	<p><b>¡Nuevo!</b></p>   <p><b>3682</b> tapón llenado aceite 1.2-1.4 r.o. 650094</p>
<p><b>¡Nuevo!</b></p>   <p><b>3683</b> tapón llenado aceite 1.4/16v-1.6/16v r.o. 650089</p>	<p><b>¡Nuevo!</b></p>   <p><b>3684</b> tapón llenado aceite 1.5D-TD-1.7D r.o. 650091</p>	<p><b>¡Nuevo!</b></p>   <p><b>3674</b> tapón llenado aceite 1.0/12v-1.2/12v r.o. 650094</p>
 <p><b>425</b> cubrepedal freno y embrague r.o. 560808</p>	 <p><b>934</b> casquillo tensor alternador r.o. 1204892 - 1204969</p>	 <p><b>811</b> soporte alternador r.o. 1204885</p>
 <p><b>2450</b> junta cónica tubo de escape Ø 42 x 57 mm r.o. 854934-854945</p>	 <p><b>2393</b> junta cónica tubo de escape Ø 46 x 60 mm r.o. 854931 - 854932</p>	 <p><b>975</b> soporte tubo de escape r.o. 852516</p>
 <p><b>2490</b> tapón de cárter Diesel y TurboDiesel r.o. 652492</p>	 <p><b>677</b> tapón de cárter 1.2-1.4 y 16v r.o. 652491</p>	 <p><b>2667</b> tapón de cárter 1.0-12v (torx con junta de goma), r.o. 652477</p>
<p><b>¡Nuevo!</b></p>  <p><b>3710</b> tapón de combustible r.o. 0808117</p>	 <p><b>2619</b> longitud perno 66 mm kit sujeción escape a colector 1.2-1.4 r.o. 854982-854881</p>	 <p><b>2620</b> longitud perno 70 mm kit sujeción escape a colector motores 16v r.o. 854986-854884</p>

SUSPENSION DELANTERA y SOPORTES DE MOTOR

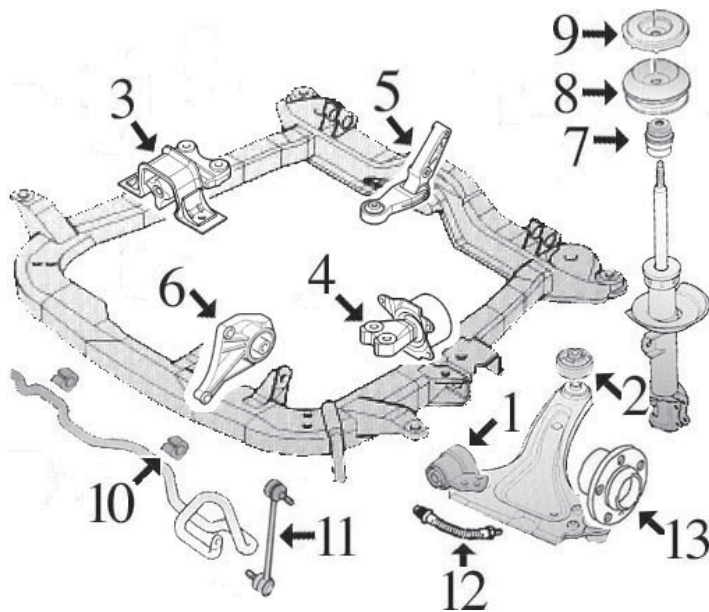

- 1- 4695 silentbloc anterior trapecio delantero
- 2- 4694 silentbloc posterior trapecio delantero
- 3- 4686 soporte motor derecho 1.0-1.2
- 4687 soporte motor dcho. 1.4-1.6-1.8-1.3DT-1.7DT/DTL
- 4- 4684 soporte motor izquierdo 1.0-1.2-1.4-1.6-1.8 y 1.7DT y Combo hasta '04
- 4692 soporte motor izquierdo 1.3DT todos y 1.7DTL desde '04
- 5- 4688 soporte motor trasero 1.0 hasta '04, 1.2 y 1.7DT
- 4689 soporte motor trasero 1.0 desde '04, 1.3DT-1.4-1.6-1.8
- 6- 4690 soporte motor delantero (limitador de par) todos salvo 1.7DT
- 7- 4698 tope de poliuretano
- 8- 4214 soporte amortiguador delantero
- 9- n/d tapa con rodamiento
- 10- 4376 goma para barra estabilizadora de 17 mm
- 4377 goma para barra estabilizadora de 19 mm
- 11- 4241 bieleta puntal barra estabilizadora
- 12- 96131 latiguillo freno delantero (310 mm)
- 13- n/d buje de rueda delantera



**4214**  
soporte amortiguador delantero  
r.o.344523-344525



**4241**  
bieleta puntal barra estabilizadora  
r.o.350610



**4376**  
goma para barra estabilizadora de 17 mm  
r.o.350130



**4377**  
goma para barra estabilizadora de 20 mm  
r.o.350143

**¡Nuevo!**



**4684**  
soporte motor izquierdo 1.0-1.2-1.3D-1.4-1.6-1.8-1.7D, r.o.684194-684189

**¡Nuevo!**

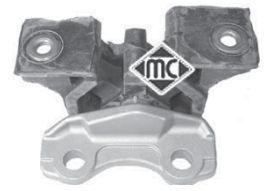

**4686**  
soporte motor derecho 1.0/1.2  
r.o.5684170-5684168

**¡Nuevo!**



**4687**  
soporte motor derecho 1.4-1.6-1.3D-1.7D-1.8, r.o.5684646-684184

**¡Nuevo!**













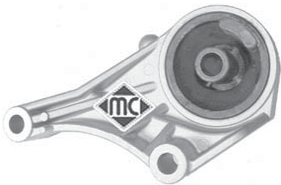













**4688**  
soporte motor trasero 1.4-1.6-1.7D-1.8-1.0-1.2  
r.o.684713+846000

**¡Nuevo!**



**4689**  
soporte motor trasero 1.0-1.2 desde '04  
r.o.684717+846000

OPEL CORSA - C (2001-2007)

<p><b>¡Nuevo!</b></p>  <p><b>4690</b> soporte motor delantero todos salvo 1.7DT r.o. 684238</p>	<p><b>¡Nuevo!</b></p>  <p><b>4692</b> soporte motor izquierdo 1.3D-1.7D r.o. 5684761</p>	 <p><b>4694</b> silentbloc posterior trapecio delantero r.o. 352310-352320</p>
<p><b>¡Nuevo!</b></p>  <p><b>4695</b> silentbloc anterior trapecio delantero r.o. 352309-352366-352377</p>	<p><b>¡Nuevo!</b></p>  <p><b>4698</b> tope poliuretano amortiguador delantero r.o. 344424</p>	
<p><b>¡Nuevo!</b></p>  <p><b>96131</b> latiguillo freno delantero (310 mm) r.o. 5562230</p>	<p><b>¡Nuevo!</b></p>  <p><b>96138</b> latiguillo freno trasero (220 mm) r.o. 562302</p>	
<p><b>¡Nuevo!</b></p>  <p><b>3732</b> botella de expansión 1.0-1.2 r.o. 1304234</p>	<p><b>¡Nuevo!</b></p>  <p><b>3673</b> botella de expansión 1.4-1.6-1.8-1.3D-1.7D r.o. 1304233</p>	 <p><b>3507</b> tapón botella de expansión r.o. 1304666</p>
<p><b>¡Nuevo!</b></p>  <p><b>4683</b> juego casquillos palanca de cambio r.o. 758925-758945</p>	<p><b>¡Nuevo!</b></p>  <p><b>4730</b> varilla nivel aceite 1.4-1.6-1.8 r.o. 658048</p>	<p><b>¡Nuevo!</b></p>  <p><b>4697</b> varilla nivel aceite 1.7D r.o. 658054</p>
<p><b>¡Nuevo!</b></p>   <p><b>3674</b> tapón llenado aceite motor 1.0-1.2-1.4-1.7D r.o. 5650831</p>	<p><b>¡Nuevo!</b></p>   <p><b>3682</b> tapón llenado aceite motor 1.6 r.o. 650094</p>	<p><b>¡Nuevo!</b></p>   <p><b>3685</b> tapón llenado aceite motor 1.3D r.o. 5650506</p>
<p><b>¡Nuevo!</b></p>  <p><b>3175</b> boquilla aluminio en bloque 1.7D r.o. 1336011</p>	<p><b>¡Nuevo!</b></p>   <p><b>8951</b> mgt desvaporizador 1.7D r.o. 656051</p>	<p><b>¡Nuevo!</b></p>   <p><b>3710</b> tapón llenado combustible r.o. 0808117</p>



## OPEL CORSA - C (2001-2007)

<p><b>¡Nuevo!</b></p>  <p><b>4719</b> polea cigüeñal 1.3D r.o. 5614438</p>	<p><b>¡Nuevo!</b></p>  <p><b>4857</b> polea cigüeñal 1.7D hasta '04 r.o. 5614444</p>	<p><b>¡Nuevo!</b></p>  <p><b>4856</b> polea cigüeñal 1.7D desde '04 r.o. 5614441</p>
<p><b>¡Nuevo!</b></p>  <p><b>4773</b> <span style="float: right;">Ø 65 mm</span> rodillo tensor correa alternador 1.4-1.6-1.8 r.o. 1340514</p>	 <p><b>1112</b> kit fuelle transmisión l/rueda (Ø 22-82 mm) r.o.</p>	 <p><b>1921</b> kit fuelle transmisión l/rueda (Ø 26-77 mm) r.o.</p>
 <p><b>1344</b> kit fuelle transmisión l/cambio r.o.</p>	<p><b>¡Nuevo!</b></p>  <p><b>1147</b> kit fuelle transmisión l/cambio con trípode (Ø 22-66mm), r.o. 1603004-1603230</p>	<p><b>¡Nuevo!</b></p>  <p><b>1148</b> kit fuelle transmisión l/cambio con trípode (Ø 22-69 mm), r.o. 1603260</p>
 <p><b>1191</b> fuelle cremallera dirección r.o.</p>	 <p><b>2428</b> soporte tubo de escape r.o. 852726</p>	 <p><b>2490</b> tapón cárter aceite 1.7D r.o. 652492</p>
 <p><b>2667</b> tapón cárter aceite "torx" r.o. 652477</p>		

## OPEL FRONTERA



**677**  
tapón cárter de aceite  
r.o. 652491



**1198**  
kit fuelle transmisión lado rueda  
r.o.

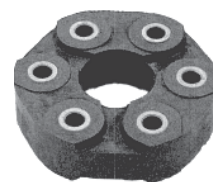

**4407**  
flector de transmisión  
r.o. 446551

**¡Nuevo!**



**96146**  
latiguillo freno delantero (435 mm)  
r.o. 562304

**¡Nuevo!**



**96147**  
latiguillo freno trasero (468 mm)  
r.o. 562307

## CANALIZACIONES DE AGUA:

### KADETT 1.3 - 1.4:

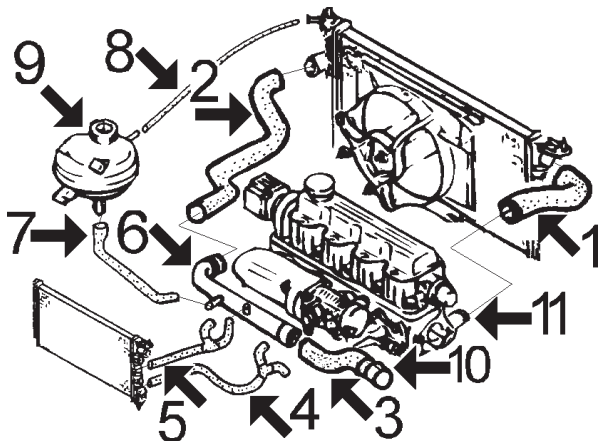

- 1- 7324 mgto superior radiador
- 2- 7605 mgto inferior radiador
- 3- 7406 mgto de tubo rígido a bomba de agua
- 4- 7662 mgto derecho de calefactor a colector de adm.
- 5- 8023 mgto izquierdo de calefactor, 1er. tramo de calefactor a T enlace
- 3046 T enlace mgto izquierdo de calefacción
- 7874 mgto izquierdo de calefactor, 2º tramo de T enlace a tubo rígido
- 6- n/d tubo de agua (plástico)
- 7- n/d mgto de botella a tubo rígido
- 8- 754 mgto de sobrante de botella a radiador: Cortar de rollo MC-754 Ø 12x19 mm (trenzado), longitud aprox. 500 mm
- 9- 3507 tapón botella expansión 1,20 bar
- 10- 3068 boquilla metálica en bloque - bomba agua
- 11- 3071 tapa de termostato (aluminio)

### KADETT 1.6 motor SH:

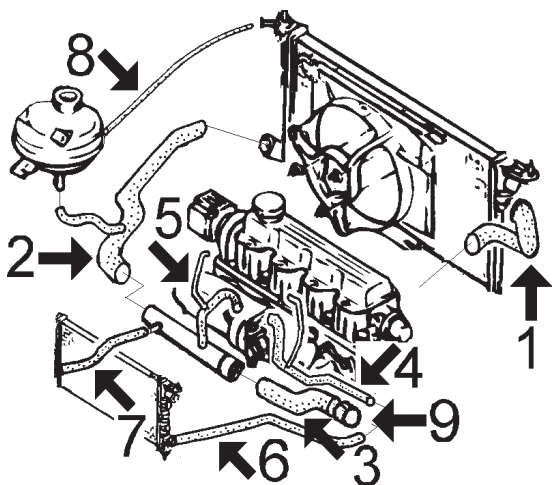

- 1- 7400 mgto superior de radiador
- 2- 7321 mgto inferior de radiador (3 vias)
- 3- 7865 mgto de tubo rígido a bomba de agua
- 4- n/d mgto de bomba de agua a colector de admisión y a carburador (3 vias)
- 5- 8083 mgto de tubo rígido a colector de admisión y a carburador (3 vias)
- 6- 8041 mgto de calefactor a bomba de agua
- 7- 7684 mgto de calefactor a tubo rígido
- 8- 754 mgto de sobrante de botella a radiador: Cortar de rollo MC-754 Ø12x19 mm (trenzado), longitud aprox. 500 mm
- 9- 3068 boquilla metálica en bloque - bomba agua

### KADETT 1.6 motor SV:

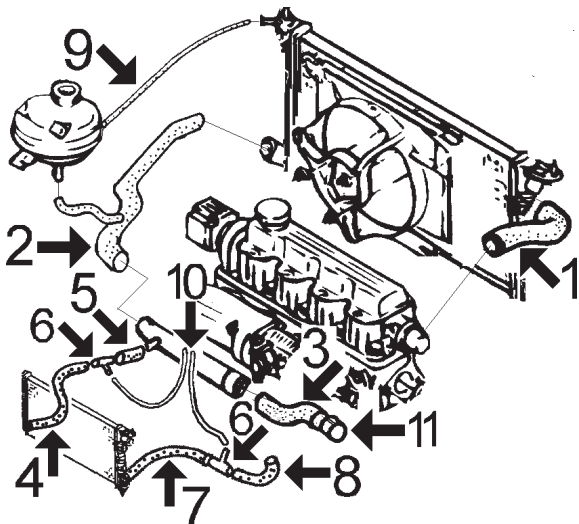

- 1- 7320 mgto superior radiador hasta '89
- 8270 mgto superior radiador de '89 a '90
- 8279 mgto superior radiador desde '90
- 2- 7321 mgto inferior radiador hasta '89 (3 vias)
- 7815 mgto inferior radiador desde '89
- 3- 7406 mgto de tubo rígido a bomba de agua
- 4- 8071 mgto izquierdo de calefactor a racor
- 5- 8098 mgto de racor a tubo rígido
- 6- 3046 racor empalme tubos de calefacción
- 7- 8023 mgto derecho de calefactor a racor
- 8- 7874 mgto de racor empalme a colector de admisión
- 754 mgto sobrante de botella a radiador: Cortar de rollo MC-754 Ø 12x19 mm (trenzado), longitud aproximada 500 mm.
- 10- 116 mgto de racor empalme tubos de calefacción a carburador: Cortar de rollo MC-116 Ø 8x14 mm longitud 250 mm (derecho) y 450 mm (izquierdo)
- 11- 3068 boquilla metálica en bloque - bomba de agua

8254 mgto desvaporizador

## OPEL KADETT

### KADETT 1.8 i (motor SE) y 2.0 i (motor NE, 8 válvulas):

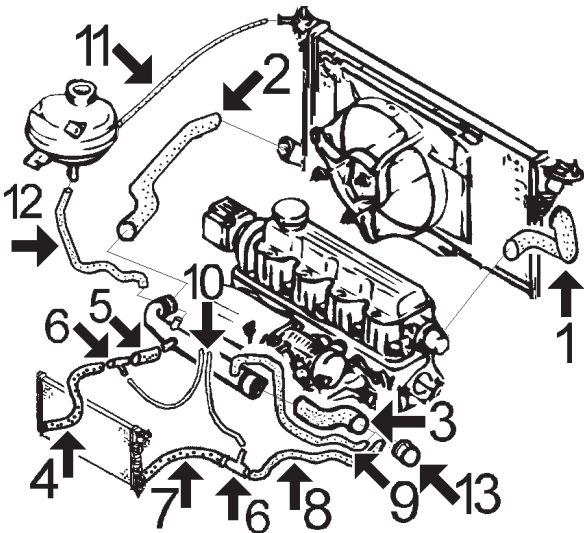

- 1- 7400 mgto superior radiador
- 2- 7815 mgto inferior radiador 1.8 i
- 7321 mgto inferior radiador 2.0 i (3 vias, alternativa-  
mente al MC-7815: la 3ª via va a la botella y no  
monta el mgto n° 12)
- 3- 8009 mgto de tubo rígido a bomba de agua
- 4- 8071 mgto izquierdo de calefactor a racor
- 5- 8098 mgto de racor a tubo rígido (2º tramo del mgto  
izquierdo de calefacción)
- 6- 3046 racor empalme tubos de calefacción
- 7- n/d mgto derecho de calefactor a racor
- 8- 8190 mgto de racor a bomba de agua (2º tramo del  
mgto derecho de calefacción)
- 9- 8146 mgto de tubo rígido a bomba de agua
- 10- 116 mgto de racor empalme tubos de calefacción a  
calentador entrada aire de admisión: Cortar de  
rollo MC-116 Ø 8x14 mm, longitud 450 mm (iz-  
quierdo) y 600 mm (derecho)
- 11- 754 mgto de sobrante botella a radiador: Cortar de  
rollo MC-754 Ø 12x19 mm (trenzado), longitud  
aprox. 500 mm
- 12- n/d mgto de botella a tubo rígido (sólo 1.8 i)
- 13- 3073 boquilla metálica en bloque - bomba de agua

### KADETT 2.0 i-16 válvulas (motor XE):

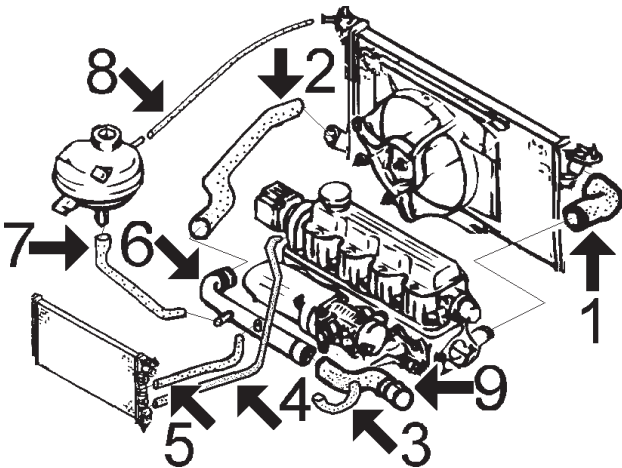

- 1- 7876 mgto superior radiador
- 2- 7815 mgto inferior radiador
- 3- 8087 mgto de tubo rígido a bomba de agua y a colec-  
tor de admisión (3 vias)
- 4- n/d mgto derecho de calefactor a culata
- 5- 8041 mgto izquierdo de calefactor a tubo rígido
- 6- n/d tubo rígido (plástico)
- 7- n/d mgto de botella a tubo rígido
- 8- 754 mgto sobrante de botella a radiador: Cortar de  
rollo MC-754 Ø 12x19 mm (trenzado), longitud  
aproximada 550 mm.
- 9- 3073 boquilla metálica en bloque - bomba de agua

n/d= no disponible

### KADETT 1.6 Diesel (hasta '89) y 1.7 Diesel (desde '89):

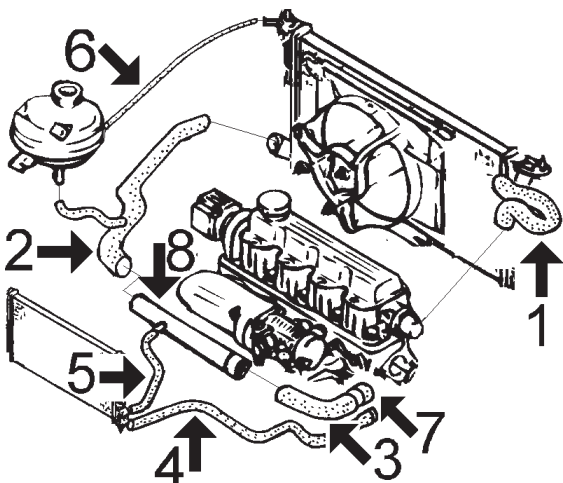

- 1- 7322 mgto superior radiador 1.6 D
- 7819 mgto superior radiador 1.7 D
- 2- 8046 mgto inferior radiador 1.6 D (3 vias)
- 7818 mgto inferior radiador 1.7 D
- 3- 7323 mgto de tubo rígido a bomba de agua
- 4- 7683 mgto de calefactor a bomba de agua
- 5- 7684 mgto de calefactor a tubo rígido
- 6- 754 mgto sobrante de botella a radiador: Cortar  
de rolo MC-754 Ø 12x19 mm (trenzado), lon-  
gitud aprox. 500 mm
- 7- 3073 boquilla metálica en bloque - bomba de agua
- 8- 3076 tubo metálico 1.7 Diésel



## OPEL KADETT

 <p><b>7320</b> mgto superior radiador 1.6 SV r.o. 1336457</p>	 <p><b>7321</b> mgto inferior radiador 1.6 - 1.8 (bocas de Ø 40 y Ø 32 mm), r.o. 1336406</p>	 <p><b>7322</b> mgto superior radiador 1.6 Diesel r.o. 1336426</p>
 <p><b>7323</b> mgto de tubo a bomba 1.6 D y 1.7 D r.o. 1336294</p>	 <p><b>7324</b> mgto superior radiador 1.3 - 1.4 r.o. 1336430</p>	 <p><b>7400</b> mgto superior radiador 1.6 SH y 1.8 r.o. 1336402</p>
 <p><b>7406</b> bocas Ø 30-35 mm mgto de tubo a bomba 1.3-1.4 y 1.6 SV r.o. 1336459</p>	 <p><b>7605</b> mgto inferior radiador 1.3 - 1.4 r.o. 1336244</p>	 <p><b>7683</b> mgto derecho calefactor 1.6 D - 1.7 D r.o. 1818324</p>
 <p><b>7684</b> mgto izquierdo calefactor 1.6 D - 1.7 D r.o. 1818334</p>	 <p><b>7815</b> mgto inferior radiador 1.6 SV desde '90, 1.8 - 2.0 y 16v., r.o. 1336327</p>	 <p><b>7818</b> mgto inferior radiador 1.7 Diesel r.o. 1337002</p>
 <p><b>7819</b> mgto superior radiador 1.7 Diesel r.o. 1337009</p>	 <p><b>7865</b> bocas Ø 32-34 mm mgto de tubo a bomba 1.6 SH r.o. 1336268</p>	 <p><b>7874</b> mgto derecho de calefactor (2º tramo) 1.6 motor SV, r.o. 1818536</p>
 <p><b>7876</b> mgto superior radiador 2.0i 16 v. r.o. 1336462</p>	 <p><b>8009</b> bocas Ø 32-37 mm mgto de tubo a bomba 1.8i-2.0i r.o. 1336812</p>	 <p><b>8023</b> mgto izqde de calefactor (1er. tramo) 1.6 SV r.o. 1818336</p>
 <p><b>8041</b> mgto derecho calefactor 1.6 SH r.o. 1818327</p>	 <p><b>8046</b> mgto inferior radiador 1.6 Diesel (bocas iguales de Ø 32 mm), r.o. 1336405</p>	







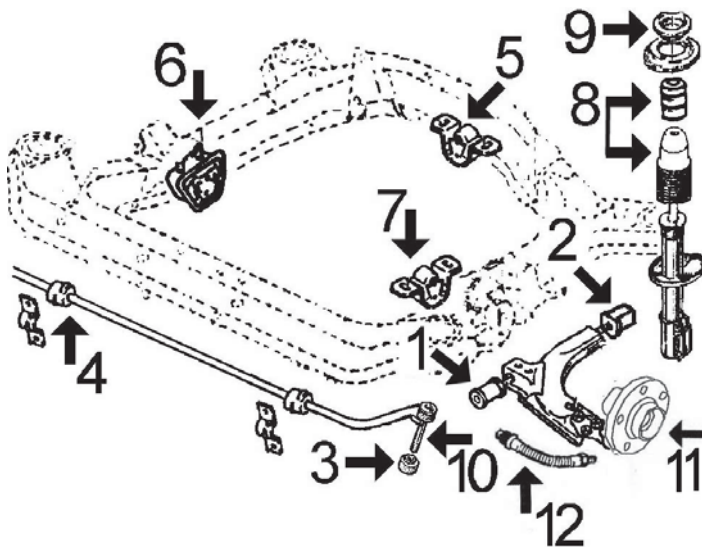



## OPEL KADETT

 <p><b>8071</b> mgto izqd. calefactor 1.8-2.0 (1er. tramo) (excepto 16v.), r.o. 90240239</p>	 <p><b>8083</b> mgto de tubo a colector y carburador 1.6 SH r.o. 1336287</p>	 <p><b>8087</b> mgto de tubo a bomba y colector 2.0i 16v. r.o. 1336328</p>
 <p><b>8098</b> mgto izqd. calefactor 1.6 SV - 1.8 y 2.0 (2º tramo), r.o.</p>	 <p><b>8146</b> mgto de tubo a bomba 1.8-2.0 (salvo 16v.) r.o. 1336509</p>	 <p><b>8190</b> mgto dcho. calefactor (2º tramo) 1.8-2.0 (salvo 16v.), r.o.</p>
 <p> <b>8254</b> mgto desvaporizador 1.6 SV / NZ r.o. 656148</p>	 <p><b>8270</b> mgto superior radiador 1.6 SV de '89 a '90 r.o. 1337053</p>	 <p><b>8279</b> mgto superior radiador 1.6 SV desde '90 r.o. 1336821</p>
 <p><b>3068</b> Ø 30 mm boquilla en bloque-bomba agua 1.3-1.4-1.6 r.o. 606400</p>	 <p><b>3073</b> Ø 34 mm boquilla en bloque-bomba agua 1.8-2.0-D r.o. 606401</p>	 <p><b>3076</b> tubo metálico 1.7 Diesel con doble tórica r.o. 1336061 + 1336570</p>
 <p><b>3046</b> racor emplame tubos calefacción 1.3-1.6SV 1.8-2.0, r.o.</p>	 <p><b>3071</b> tapa de termostato 1.3-1.4 r.o. 1338151</p>	 <p><b>3507</b> tapón botella expansión 1,20 bar r.o. 1304667</p>
 <p><b>3511</b> botella de expansión gasolina y Diesel r.o. 1304622(1304614)</p>	 <p><b>2356</b> Ø 41x48 mm juntas de termostato 1.3-1.4 r.o.</p>	 <p><b>2357</b> Ø 46x56 mm junta de termostato 1.6-1.8 r.o.</p>

SUSPENSION DELANTERA y SOPORTES DE MOTOR:

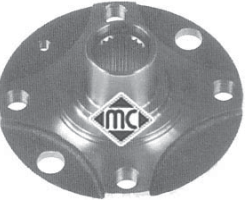
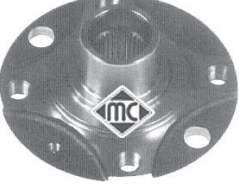

- 1- 655 silentbloc anterior trapecio delantero
- 2- 804 silentbloc posterior trapecio delantero
- 3- 640 goma bieleta barra estabilizadora
- 4- n/d goma barra estabilizadora
- 5- 729 soporte de motor trasero todos mods.
- 6- 725-C soporte de motor derecho 1.3-1.4 y 1.6 SV
- 725-L soporte de motor derecho 1.6 SH-1.8-2.0
- 727 soporte de motor derecho 1.6 D y 1.7 D
- 7- 728 soporte de motor izquierdo todos mods.
- 8- 4727 juego tope de poliuretano y capuchón amortiguador delantero
- 9- 2661 soporte amortiguador delantero con rodamiento
- 10- 2651 bieleta puntal barra estabilizadora completa
- 11- 90004 buje rueda delantera (22 estrías)
- 90005 buje rueda delantera (33 estrías)
- 12- 96158 latiguillo freno delantero derecho (310 mm)
- 96139 latiguillo freno delantero izquierdo (325 mm)

 <p><b>655</b> silentbloc anterior trapecio delantero r.o. 352334 352330</p>	 <p><b>804</b> silentbloc posterior trapecio delantero r.o. 352335 - 352338</p>	 <p><b>2661</b> con rodamiento soporte amortiguador delantero r.o. 344508-344509</p>
 <p><b>2651</b> bieleta puntal barra estabilizadora completa r.o. 350153+2089300+2000301</p>	 <p><b>640</b> goma bieleta barra estabilizadora r.o. 350153</p>	 <p><b>4727</b> juego tope poliuretano y capuchón amortiguador delantero, r.o. 344401</p>
 <p><b>90004</b> buje rueda delantera de 22 estrías r.o. 326197</p>	 <p><b>90005</b> buje rueda delantera de 33 estrías r.o. 326194</p>	 <p><b>90524</b> buje rueda trasera r.o. 1604307</p>
 <p><b>96158</b> latiguillo freno delantero <b>derecho</b> (310 mm) r.o. 562345</p>	 <p><b>96139</b> latiguillo freno delantero <b>izquierdo</b> (325 mm) r.o. 562344</p>	 <p><b>96159</b> latiguillo freno trasero (195 mm) r.o. 562346</p>

## OPEL KADETT



**2652**  
silentbloc soporte puente trasero  
r.o.402642



**2491**  
goma ballesta trasera COMBO  
r.o.430051



**728**  
soporte de motor izquierdo todos modelos  
r.o.684257



**725-C**  
soporte de motor izquierdo 1.3-1.4-1.6SV  
r.o.684195



**725-L**  
soporte de motor derecho 1.6SH-1.8-2.0  
r.o.684263

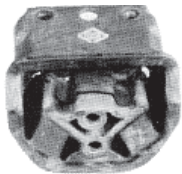

**727**  
soporte motor dcho. 1.6D y 1.7D  
r.o.684267-684265



**729**  
soporte de motor trasero todos modelos  
r.o.682549



**4782**  
polea cigüeñal 1.5TD motor Isuzu  
r.o.5614417

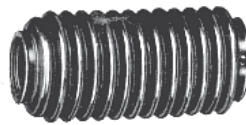

**1550 kit 550 fuelle**  
fuelle cremallera dirección manual  
r.o.443010



**1773**  
fuelle cremallera asistida "ZF"  
r.o.1609076



**1822**  
fuelle cremallera asistida "SAGINAW"  
r.o.1609068



**4301**  
silentbloc barras cremallera dirección  
r.o.



**934**  
casquillo tensor alternador todos mods.  
r.o.1204892



**810**  
soporte alternador 1.3-1.4-1.6SV  
r.o.1204580



**811**  
soporte alternador 1.6SH-1.6D-1.7D-1.8 y 2.0,r.o.1204885

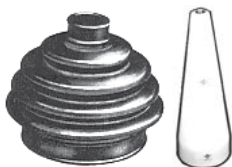

**1359-E** para montar con cono  
kit rep. transmisión l/rueda 1.3-1.4-1.6SV  
r.o.374019



**1359**  
kit rep. transmisión l/rueda 1.3-1.4-1.6SV  
r.o.374019



**1575**  
kit rep. transm.l/rueda 1.6SH-1.6D-1.7D-1.8-2.0,r.o.374050



## OPEL KADETT

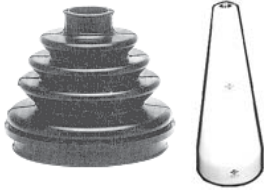

**1575-E**

kit rep. transm. l/rueda 1.6SH-1.6D-1.7D-1.8-2.0, r.o. 374050



**1490**

kit rep. transm. l/cambio 1.3-1.4-1.6SV r.o. 374018



**1730**

kit rep. transm. l/cambio 1.6SH-1.6D-1.7D-1.8y 2.0, r.o. 374040



**2489**

juego casquillos palanca de cambio r.o. 758711 - 736701 - 758743



**935**

soporte bomba de gasolina 1.8-2.0 r.o. 817744



**425**

cubrepedal freno y embrague r.o. 560808



**649**

soporte tubo de escape 1.3-1.4-1.6-1.8-2.0 (Ø 36 x 65), r.o. 852711



**366**

soporte tubo de escape Diesel (Ø 32 x 59) r.o. 852713



**085**

soporte escape 1.8-2.0 r.o. 856700



**554**

soporte escape todos desde '84 r.o. 852719

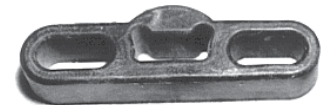

**786**

soporte escape hasta '84 r.o. 852717



**2393**

junta cónica tubo de escape Ø 46 x 60 mm 1.6-1.8, r.o. 560808



**2431**

junta cónica tubo de escape Ø 50 x 67 mm 2.0 y 16v., r.o. 854947



**2619**

longitud perno 66 mm kit sujeción escape a colector 1.6 r.o. 854982 - 854881



**815**

tuerca rueda r.o. 1008501



**677**

tapón cárter de aceite todos salvo 1.5TD (14x150 tuerca de 19 mm), r.o. 652491



**2490**

tapón cárter de aceite 1.5 TurboDiesel (14x150 tuerca de 22 mm), r.o. 652492

**SUSPENSION DELANTERA y SOPORTES de MOTOR (tracción delantera):  
motores 1.9D (F9Q), 2.2D (G9T), 2.5D (G9U y S8U), 2.8D (S9W) y 3.0D (ZD3)**

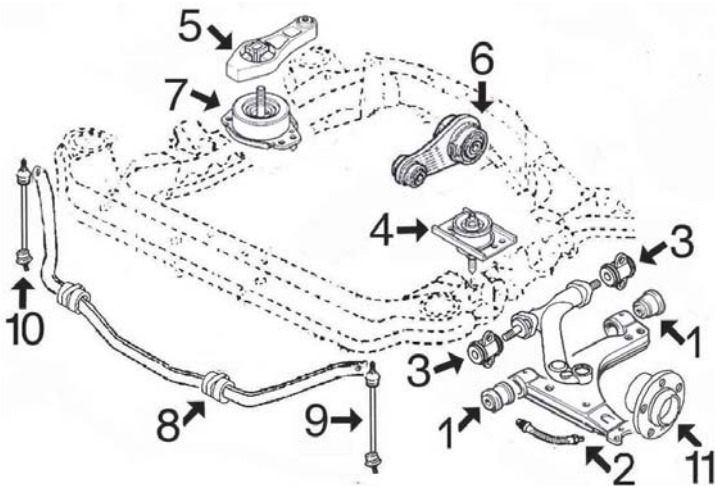

- 1- 4777 juego silentblocs trapecio inferior delantero
- 2- 96206 latiguillo freno delantero
- 3- 4778 silentbloc trapecio superior delantero
- 4- 4116 soporte motor izquierdo
- 5- 4775 tirante reacción derecho 1.9D
- 6- 4118 soporte motor trasero
- 7- 4835 soporte motor derecho 1.9DTi
- 4117 soporte motor derecho 2.5D (S8U) y 2.8D
- 4776 soporte motor derecho 2.2D y 2.5D (G9U)
- 8- 4404 goma barra estabilizadora
- 9- 4400 bieleta puntal izquierdo barra estabilizadora
- 10- 4399 bieleta puntal derecho barra estabilizadora
- 11- n/d buje rueda delantera de 15"
- n/d buje rueda delantera de 16"

**SUSPENSION TRASERA (modelos con tracción delantera)**

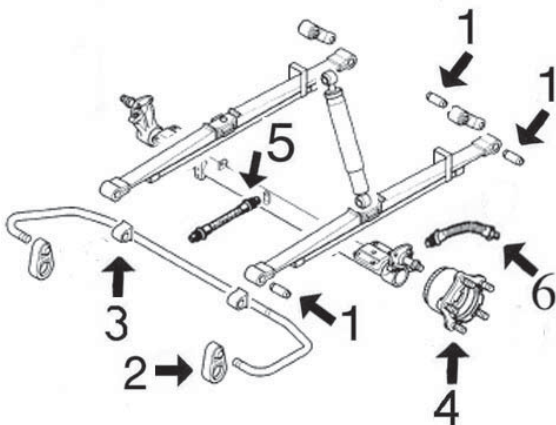

- 1- 4779 juego 3 silentblocs ballesta trasera
- 2- n/d puntal barra estabilizadora trasera
- 3- n/d goma barra estabilizadora trasera
- 4- n/d buje rueda trasera
- 5- 96207 latiguillo intermedio freno trasero
- 96208 latiguillo freno trasero de 355 mm
- 96209 latiguillo freno trasero de 270 mm

## OPEL MOVANO (1998- )



**4116**

soporte motor izquierdo todos modelos  
r.o. 8200199149



**4117**

soporte motor derecho 2.5D(S8U) y 2.8D  
r.o. 8200022595



**4118**

soporte motor trasero todos modelos  
r.o. 7700308756

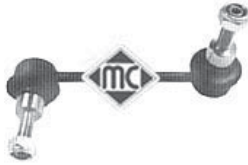

**4399**

bieleta puntal **derecho** barra estabilizadora  
r.o.



**4400**

bieleta puntal **izquierdo** barra estabilizadora  
r.o.



**4404**

goma barra estabilizadora delantera  
r.o.

**¡Nuevo!**



**4775**

tirante reacción en soporte derecho 1.9DTi  
r.o. 8200073669

**¡Nuevo!**



**4776**

soporte motor derecho 2.2D y 2.5D (G9U)  
r.o. 8200022596

**¡Nuevo!**



**4777**

juego silentblocs trapezio inferior delant.  
r.o. 7700302122+7700302123

**¡Nuevo!**



**4778**

silentbloc trapezio superior delantero  
r.o. 7700302115

**¡Nuevo!**



**4779**

juego silentblocs ballesta trasera  
r.o. 8200024453+8200024454

**¡Nuevo!**



**4835**

soporte motor derecho 1.9DTi  
r.o. 8200072229

**¡Nuevo!**



**96206**

latiguillo freno delantero (582 mm)  
r.o. 5010422700

**¡Nuevo!**



**96207**

latiguillo freno intermedio trasero (433 mm)  
r.o. 7700309823

**¡Nuevo!**



**96208**

latiguillo freno trasero de 355 mm  
r.o. 8200086894



















**¡Nuevo!**



**96209**

latiguillo freno trasero de 270 mm  
r.o. 5010422009

## OPEL MOVANO (1998- )

<p><b>¡Nuevo!</b></p>  <p><b>3645</b> 89° caja con termostato completa 1.9D (89°) r.o. 8200074346</p>	<p><b>¡Nuevo!</b></p>  <p><b>3661</b> 83° caja con termostato completa 1.9D (83°) r.o. 8200074349</p>	<p><b>¡Nuevo!</b></p>  <p><b>3646</b> caja de termostato completa 2.2D-2.5D, 83° r.o. 8200262237-8200262241-8200154296</p>
 <p><b>3563</b> tapón botella de expansión r.o. 7700805131</p>	 <p><b>3124</b> tubo de agua metálico 2.8HDi-Sofim S9W r.o. 7701044895</p>	<p><b>¡Nuevo!</b></p>  <p><b>3717</b> decantador completo 1.9 Diesel r.o.</p>
<p><b>¡Nuevo!</b></p>  <p><b>4455</b> 6 canales polea cigueñal 1.9 Diesel r.o. 8200079183</p>	<p><b>¡Nuevo!</b></p>  <p><b>4666</b> 7 canales polea cigueñal 1.9 Diesel r.o. 8200297937</p>	<p><b>¡Nuevo!</b></p>  <p><b>4463</b> polea cigueñal 2.2/2.5 Diesel r.o. 8200213058</p>
<p><b>¡Nuevo!</b></p>  <p><b>4585</b> 7 canales polea cigueñal 2.2/2.5 Diesel r.o. 8200207435</p>	<p><b>¡Nuevo!</b></p>  <p><b>4568</b> 5+6 canales polea cigueñal 2.8 Diesel r.o.</p>	<p><b>¡Nuevo!</b></p>  <p><b>4728</b> sólida polea alternador 5 canales r.o.</p>
<p><b>¡Nuevo!</b></p>  <p><b>4729</b> sólida polea alternador 6 canales r.o.</p>	<p><b>¡Nuevo!</b></p>  <p><b>4947</b> desembragable polea alternador 5 canales r.o. 8200113636</p>	<p><b>¡Nuevo!</b></p>  <p><b>4948</b> desembragable polea alternador 6 canales r.o. 7700110616</p>
<p><b>¡Nuevo!</b></p>  <p><b>4912</b> Ø 61,00 mm polea de alternador de rueda libre r.o.</p>	<p><b>¡Nuevo!</b></p>  <p><b>4913</b> Ø 53,30 mm polea de alternador de rueda libre r.o.</p>	<p><b>¡Nuevo!</b></p>  <p><b>4914</b> Ø 55,40 mm polea de alternador de rueda libre r.o.</p>
<p><b>¡Nuevo!</b></p>  <p><b>4994</b> polea árbol de levas 1.9DTi-DCi (F9Q) r.o. 7700866844-7700107401</p>		



## OPEL MOVANO (1998- )



**3617**

tapón llenado aceite motor  
r.o. 8200096805

**¡Nuevo!**



**4724**

varilla nivel aceite motor 2.2/2.5 Diesel  
r.o. 8200086256

**¡Nuevo!**



**4725**

varilla nivel aceite motor 1.9D  
r.o. 8200138515



**1520**

kit fuelle transmisión l/rueda (Ø 27/90 mm)  
r.o. 7701473176



**1225**

kit fuelle transmisión l/rueda (Ø 30/98 mm)  
r.o. 7701472975



**2304**

rodamiento de Ø 28.0 mm  
kit fuelle transmisión **izquierda** l/cambio  
(Ø exterior boca grande 114 mm)

**¡Nuevo!**



**1139**

rodamiento de Ø 28.0 mm  
kit fuelle transmisión **izquierda** l/cambio  
(Ø exterior boca grande 105 mm)

**¡Nuevo!**



**1135**

kit fuelle transmisión **derecha** l/cambio  
r.o. 7701470910



**1107**

fuelle cremallera dirección (Ø 13/53 mm)  
r.o.



**1530**

fuelle cremallera dirección (Ø 10/42 mm)  
r.o. 7701470361



**667**

tapón cárter de aceite 1.9D  
r.o. 7703075210



**670**

tapón cárter de aceite 2.2/ 2.5D  
r.o. 7903075033



**2722**

soporte tubo de escape todos mods.  
r.o.

**¡Nuevo!**



**9095**

mgto desvaporizador con válvula 1.9 Diesel  
r.o. 8200063371-8200136128

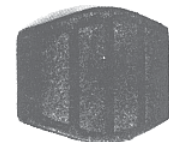

**417**

cubrepedal freno y embrague  
r.o. 7700680836

## OPEL OMEGA



**2646**  
soporte árbol de transmisión  
r.o. 458009

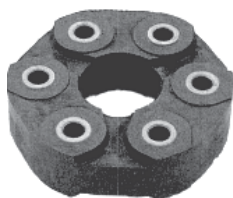

**928**  
flector de transmisión  
r.o. 458364

Ø 109 mm



**270**  
soporte tubo de escape OMEGA hasta '92  
r.o. 852716



**2428**  
soporte tubo de escape OMEGA desde '92  
r.o. 852726



**677**  
tapón cárter de aceite  
r.o. 652491

## OPEL VECTRA - A (1989-1995)

### CANALIZACIONES DE AGUA (hasta modelo '96)

#### VECTRA 1.6 (motor SV)

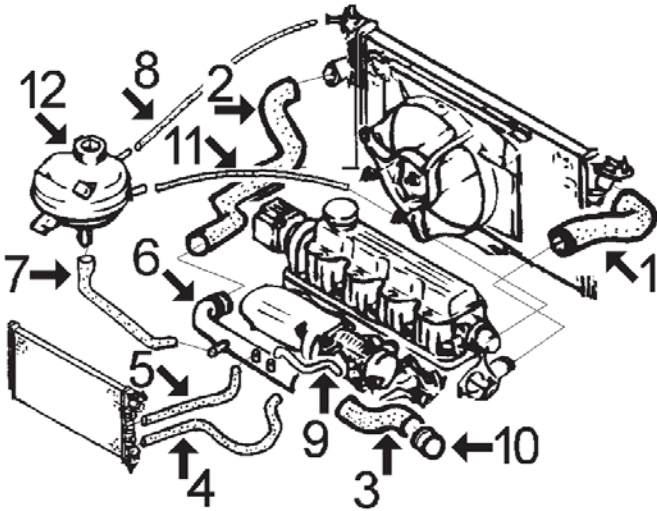

- 1- 8005 mgto superior radiador
- 2- 8006 mgto inferior radiador
- 3- n/d mgto bomba de agua hasta '91 (3 vias)
- 8244 mgto bomba de agua desde '91
- 4- n/d mgto de calefactor a colector
- 5- n/d mgto de calefactor a tubo rígido
- 6- 3179 tubo de agua rígido
- 7- n/d mgto de botella a tubo rígido
- 8- n/d mgto de sobrante de botella a radiador
- 9- n/d mgto de tubo rígido a colector
- 10- 3068 boquilla metálica entrada a bomba agua
- 11- n/d mgto de botella a caja de termostato
- 12- 3632 botella de expansión
- 3507 tapón botella de expansión

8254 mgto desvaporizador

#### VECTRA 1.8-2.0 (motores 1.8NE, 2.0NE y 2.0SEH) y 2.0-16v (motor 2.0XE)

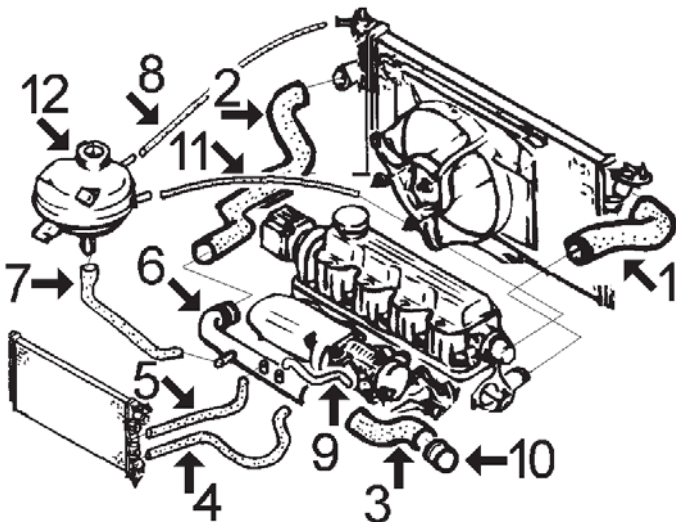

- 1- 8008 mgto superior radiador sin aire acondicionado
- 8278 mgto superior radiador con aire acondicionado
- 2- 8006 mgto inferior radiador
- 3- 8009 mgto de tubo a bomba de agua 2.0 salvo 16v.
- 8087 mgto de tubo a bomba de agua 16v.
- 4- 8338 mgto de calefactor a colector 2.0 salvo 16v.
- 5- 8286 mgto de calefactor a tubo rígido salvo 16v.
- 8287 mgto de calefactor a tubo rígido 16v.
- 6- 3184 tubo de agua rígido
- 7- 7908 mgto de botella a tubo rígido
- 8- n/d mgto de sobrante de botella a radiador
- 9- 8146 mgto de tubo rígido a bomba de agua
- 10- 3073 boquilla metálica entrada bomba de agua
- 11- n/d mgto de botella a caja de termostato
- 12- 3632 botella de expansión
- 3507 tapón botella expansión sin sensor de nivel

#### VECTRA 1.7 Diesel

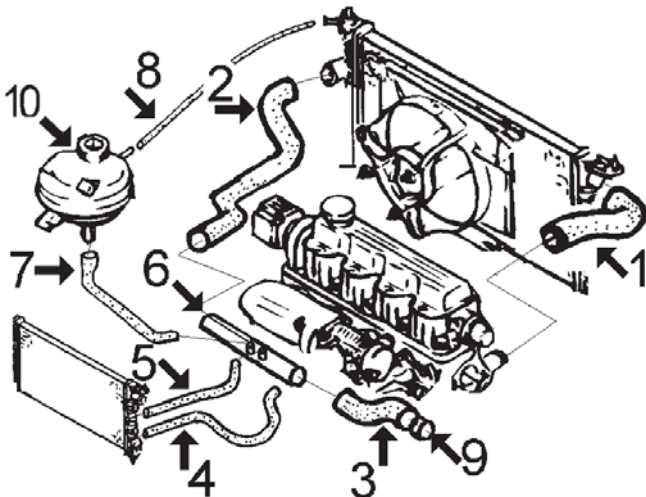

- 1- 8011 mgto superior radiador
- 2- 8012 mgto inferior radiador
- 3- 7323 mgto de tubo rígido a bomba de agua
- 4- 8337 mgto de calefactor a bomba de agua
- 5- 8287 mgto de calefactor a tubo rígido
- 6- 3076 tubo de agua metálico
- 7- 7665 mgto de botella a tubo rígido
- 8- n/d mgto de sobrante de botella a radiador
- 9- 3068 boquilla metálica entrada agua a bomba
- 10- 3633 botella de expansión
- 3507 tapón botella de expansión sin sensor de nivel

8254 mgto desvaporizador

8341 mgto desvaporizador

VECTRA 1.7 TURBOD (motor ISUZU):

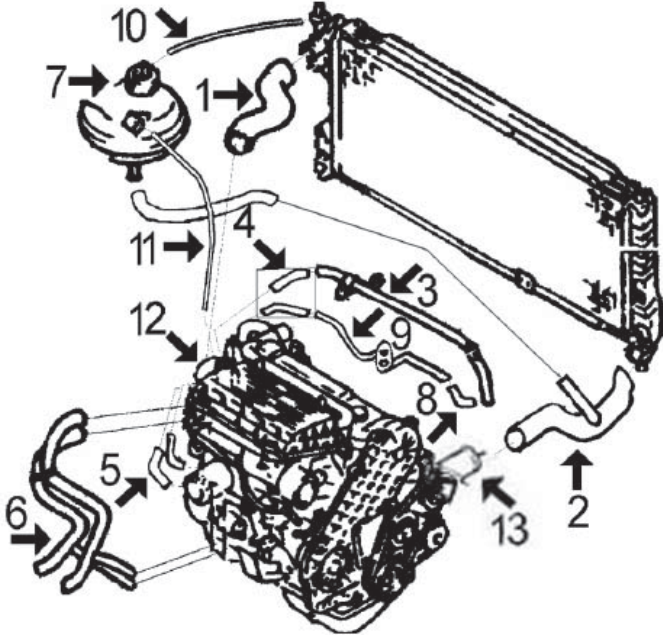

- 1- 8848 mgto superior radiador
- 2- 8849 mgto inferior radiador
- 3- 3160 tubo de agua metálico hasta '94  
3127 tubo de agua metálico desde '94
- 4- 8115 juego mgto de caja termostato a tubo metálico
- 5- 8196 juego mgto de intercambiador filtro de aceite
- 6- 8280 mgto doble de calefactor
- 7- 3633 botella de expansión  
3507 tapón botella de expansión sin sensor de nivel
- 8- 8033 mgto unión tubos metálicos
- 9- 3161 tubo metálico a Turbo con junta
- 10- 8272 mgto de sobrante de botella a radiador
- 11- 8339 mgto de sobrante de botella a termostato
- 12- 3162 caja de termostato
- 13- 4693 boquilla aluminio



**7323**  
mgto de tubo a bomba de agua 1.7 Diesel  
r.o. 1336294



**7908**  
mgto de botella a tubo rígido 2.0  
r.o. 1337087



**8005**  
mgto superior radiador 1.6  
r.o. 1336485



**8006**  
mgto inferior radiador 1.6 y 2.0  
r.o. 1336487



**8008**  
mgto superior radiador 2.0 sin aire acond.  
r.o. 1336496



**8009** bocas Ø 32-37 mm  
mgto de tubo a bomba de agua 2.0  
r.o. 1336812























**8011**  
mgto superior radiador 1.7 Diesel  
r.o. 1336499



**8012**  
mgto inferior radiador 1.7 Diesel  
r.o. 1336500



## OPEL VECTRA - A (1989-1995)

 <p><b>8033</b> mgto unión tubos metálicos 1.7 TurboD r.o. 1336509</p>	 <p><b>8087</b> mgto de tubo a bomba de agua 16v r.o. 1336328</p>	 <p><b>8115</b> jgo mgto de caja termostato a tubo me- tálico 1.7 TurboD, r.o.</p>
 <p><b>8146</b> mgto de tubo a bomba de agua 2.0 r.o. 1336509</p>	 <p><b>8196</b> jgo mgto intercambiador filtro aceite r.o. 650872-650873</p>	 <p><b>8244</b> bocas Ø 30-39 mm mgto de tubo a bomba de agua 1.6 d/91 r.o. 1337095</p>
 <p><b>8254</b> mgto desvaporizador 1.6 y Diesel r.o. 656234</p>	 <p><b>8272</b> mgto de botella a radiador 1.7 TurboD r.o. 1337118</p>	 <p><b>8278</b> mgto superior radiador 2.0 aire acondic. r.o. 1336495</p>
 <p><b>8286</b> mgto de calefactor a tubo rígido 2.0 r.o. 6818317 - 1818085</p>	 <p><b>8287</b> mgto de calefactor a tubo Diesel y 16v. r.o. 1818167 - 1818203</p>	 <p><b>8337</b> mgto de calefactor a bomba 1.7 Diesel r.o. 1818068</p>
 <p><b>8338</b> mgto de calefactor a colector 2.0 r.o. 1818580-1818188</p>	 <p><b>8339</b> mgto de sobrante botella a termostato 1.7 TurboDiesel, r.o. 1337120</p>	
 <p><b>8848</b> mgto superior radiador 1.7 TurboDiesel r.o.</p>	 <p><b>8849</b> mgto inferior radiador 1.7 TurboDiesel r.o.</p>	 <p><b>8280</b> mgto doble calefactor 1.7 TurboDiesel r.o.</p>
 <p><b>7665</b> mgto de botella a tubo rígido 1.7 Diesel r.o.</p>	 <p><b>3068</b> Ø 30 mm boquilla metálica en bloque-bomba agua 1.6, r.o. 606400</p>	 <p><b>3073</b> Ø 34 mm boquilla metálica en bloque-bomba agua 1.8-2.0-16v y Diesel, r.o. 606401</p>

OPEL VECTRA - A (1989-1995)



**3632**  
botella de expansión 1.6-1.8-2.0  
r.o. 1304640



**3633**  
botella de expansión 1.7D-1.7TD  
r.o. 1304631



**3507**  
tapón botella de expansión  
r.o. 1304666



**3076**  
tubo de agua metálico 1.7 Diesel con juntas  
tóricas, r.o. 1336063



**3127**  
tubo de agua metálico 1.7 TurboDiesel  
desde '94, r.o.



**3160**  
tubo de agua metálico 1.7 TurboDiesel  
hasta '94, r.o. 1336067



**3161**  
tubo de agua metálico a Turbo con junta,  
1.7TD, r.o. 1336066+1336573



**3162**  
caja de termostato 1.7TD  
r.o. 1338182-1338188



**4693**  
boquilla aluminio 1.7TD  
r.o. 606406



**3179**  
tubo de agua 1.6 SV  
r.o.





**3184**  
tubo de agua 1.8-2.0  
r.o.

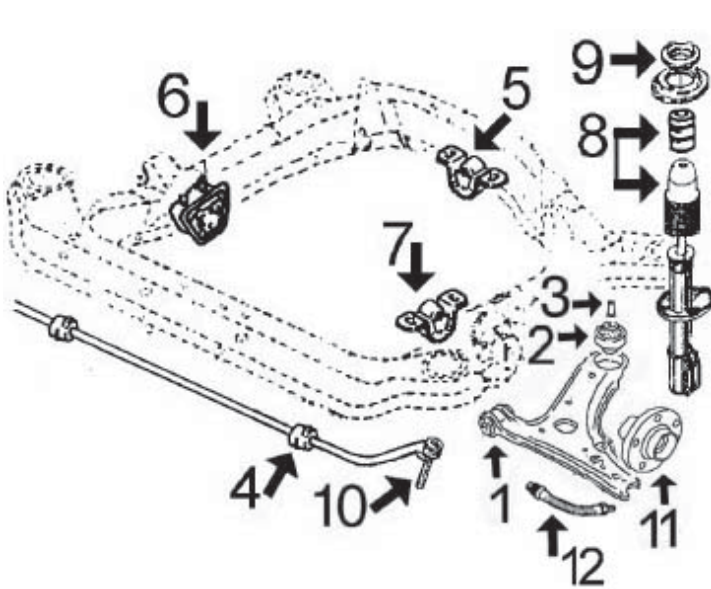













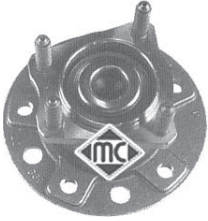



SUSPENSION DELANTERA y SOPORTES DE MOTOR:

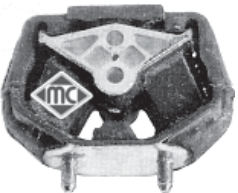

- 1- 982 silentbloc anterior trapecio delantero
- 2- 983 silentbloc posterior trapecio delantero
- 3- 4027 casquillo en silentbloc posterior trapecio
- 4- 2710 goma barra estabilizadora
- 5- 2672 soporte de motor trasero
- 6- 797 soporte de motor derecho 1.4-1.6-y Diesel
- 797 soporte de motor derecho 1.8-2.0 y 16v. hasta '93
- 2682 soporte de motor derecho 1.8-2.0 y 16v. desde '93
- 4004 soporte de motor derecho 1.7 TurboD
- 7- 728 soporte de motor izquierdo todos
- 8- 4727 juego tope poliuretano y capuchón amortiguador delantero
- 9- 2665 soporte amortiguador completo con rodamiento
- 4921 rodamiento soporte amortiguador
- 10- 2628 bieleta puntal para barra estabiliz. de Ø 22 mm hasta '95
- 2629 bieleta puntal para barra estabiliz. de Ø 18 mm hasta '95
- 4282 bieleta puntal barra estabilizadora desde '95 (con rótula)
- 640 goma bieleta puntal barra estabilizadora
- 11- 90004 buje rueda delantera 1.4-1.6 (22 estrías)
- 90005 buje rueda delantera 1.8-2.0-1.7TD (33 estrías)
- 12- 96158 latiguillo freno delantero (315 mm)

















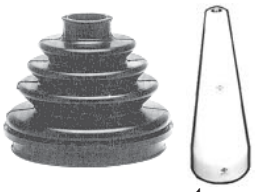

 <p><b>982</b> silentbloc posterior trapecio delantero r.o.352300</p>	 <p><b>983</b> silentbloc anterior trapecio delantero r.o.352348</p>	 <p><b>4027</b> casquillo en silentbloc posterior trapecio r.o.353460</p>
 <p><b>2628</b> para barra de Ø 22 mm bieleta puntal barra estabilizadora completa hasta '95, r.o. 350260+350153</p>	 <p><b>2629</b> para barra de Ø 18 mm bieleta puntal barra estabilizadora completa hasta '95, r.o. 350261+350513</p>	 <p><b>4282</b> bieleta puntal barra estabilizadora desde '95, r.o. 350263</p>
 <p><b>640</b> goma bieleta puntal barra estabilizadora r.o.350153</p>	 <p><b>2665</b> soporte amortiguador delantero <b>completo con rodamiento</b>, r.o.344513-344514</p>	 <p><b>4921</b> rodamiento soporte amortiguador delata. r.o.0344516</p>

## OPEL VECTRA - A (1989-1995)

<p><b>¡Nuevo!</b></p>  <p><b>4727</b> juego tope poliuretano y capuchón amortiguador delantero, r.o. 344401</p>	 <p><b>2710</b> goma barra estabilizadora r.o. 350123 - 350078 - 350081</p>	 <p><b>96158</b> latiguillo freno delantero (315 mm) r.o. 562345</p>
 <p><b>96159</b> latiguillo freno trasero (235 mm) r.o. 562346</p>	 <p><b>2708</b> silentbloc brazo suspensión trasera r.o. 402645</p>	 <p><b>90524</b> buje rueda trasera (con rodamiento) r.o. 1604307</p>
 <p><b>90004</b> buje rueda delantera 1.4-1.6 (22 estrías) r.o. 326197</p>	 <p><b>90005</b> buje rueda delantera 1.8-2.0-1.7TurboD (33 estrías), r.o. 326184</p>	 <p><b>728</b> soporte motor izquierdo r.o. 684289-684285-684641-684643</p>
 <p><b>797</b> soporte motor derecho salvo 2.0, 16v y TD r.o. 684283-684667-684291</p>	 <p><b>2682</b> soporte motor derecho 1.8-2.0 y 16v. r.o. 642007-684646</p>	 <p><b>4004</b> soporte motor derecho 1.7 TurboDiesel r.o.</p>
 <p><b>2672</b> soporte motor trasero r.o. 682601-684647-682504</p>	<p><b>¡Nuevo!</b></p>  <p><b>3682</b> tapón llenado aceite motor 1.6-1.8-2.0-1.7D r.o. 650089</p>	<p><b>¡Nuevo!</b></p>  <p><b>3683</b> tapón llenado aceite motor 1.7TD r.o. 650094</p>
<p><b>¡Nuevo!</b></p>  <p><b>4782</b> polea cigueñal 1.5D/TD-1.7D r.o. 5614417-614637</p>	 <p><b>2489</b> juego casquillos palanca cambio r.o. 758711-736701-758743</p>	 <p><b>4283</b> bieleta mando cambio r.o. 758801</p>
 <p><b>4301</b> silentbloc barras cremallera dirección r.o.</p>	 <p><b>1773</b> fuelle cremallera asistida "ZF" r.o.</p>	 <p><b>1822</b> fuelle cremallera asistida "SAGINAW" r.o. 1609068</p>



## OPEL VECTRA - A (1989-1995)

 <p><b>810</b> soporte alternador de 70A r.o. 1204580</p>	 <p><b>811</b> soporte tensor alternador todos r.o. 1204885</p>	 <p><b>2492</b> manguito cuerpo de inyección 16v. r.o. 838276</p>
 <p><b>935</b> soporte bomba de gasolina 1.8-2.0 r.o. 817744</p>	 <p><b>2823</b> soporte filtro de aire r.o. 834976</p>	 <p><b>5091</b> tensor correa alternador 1.6-1.8-2.0 r.o. 1340544-1340541</p>
 <p><b>1575</b> kit rep. transmisión/l/rueda 1.6-1.8-2.0-D yTD, r.o. 374050</p>	 <p><b>1575-E</b> para montar con cono kit rep. transmisión/l/rueda 1.6-1.8-2.0-D yTD, r.o. 374050</p>	 <p><b>1730</b> kit rep. transmisión/l/cambio 1.4-1.6-1.7D 1.8 y 2.0, r.o. 374019</p>
 <p><b>2619</b> perno longitud 66 mm kit sujeción escape a colector r.o. 854982 - 854881</p>	 <p><b>2620</b> perno longitud 70 mm kit sujeción escape a colector r.o. 854986 - 854884</p>	 <p><b>059</b> soporte tubo de escape r.o. 852723</p>
 <p><b>058</b> soporte tubo de escape r.o. 852722</p>	 <p><b>2393</b> junta cónica tubo escape Ø 46 x 60 mm r.o. 560808</p>	 <p><b>2431</b> junta cónica tubo escape Ø 50 x 67 mm r.o. 854947</p>
 <p><b>085</b> soporte tubo de escape r.o. 856700</p>	 <p><b>425</b> cubrepedal freno y embrague r.o. 560808</p>	 <p><b>677</b> tapón de cárter 1.4-1.6-1.8-2.0 y D 14x150 tuerca de 19 mm, r.o. 652491</p>
 <p><b>2490</b> tapón de cárter 1.7 TurboD 14x150 tuerca de 22, r.o. 652492</p>	 <p><b>2667</b> tapón de cárter modelo '96 (torx con junta de goma), r.o. 652477</p>	

## OPEL VECTRA-B (1996-2002)

### CANALIZACIONES DE AGUA:

VECTRA-B 1.6/16v motor X16XEL

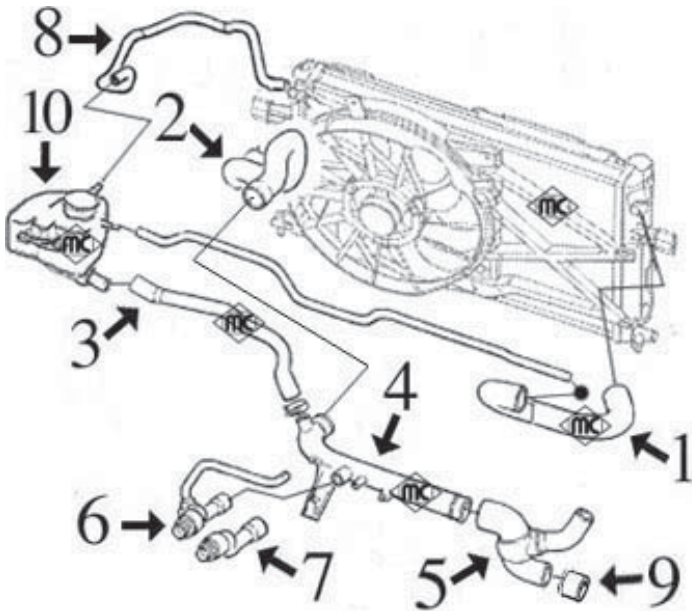

- 1- 9105 mgto superior radiador
- 2- 9104 mgto inferior radiador
- 3- 9106 mgto de tubo rígido a botella expansión
- 4- 3183 tubo de agua rígido
- 5- 8966 mgto de tubo a bomba de agua
- 6- 9103 mgto entrada a calefactor
- 7- 9102 mgto retorno calefactor
- 8- 9101 mgto de botella a radiador
- 9- 3068 boquilla metálica en bloque Ø 30 mm
- 10- 3630 botella de expansión  
3507 tapón botella de expansión

9056 mgto desvaporizador

VECTRA-B 1.8/16v motor X18XE  
2.0 y 2.0/16v motores C20SEL y X20XEL

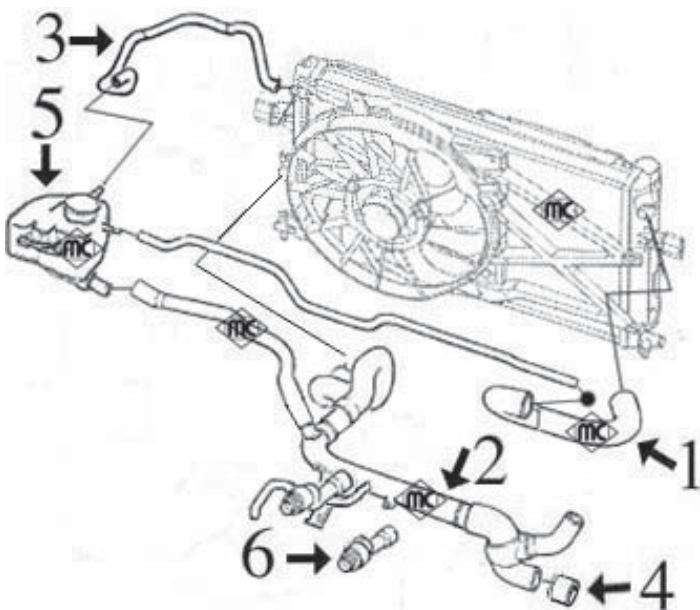

- 1- 9108 mgto superior radiador
- 2- 9107 mgto inferior radiador completo con tubo rígido, mgto a botella, a calefactor y a bomba de agua
- 3- 9101 mgto de radiador a botella de expansión
- 4- 3068 boquilla metálica en bloque Ø 30 mm
- 5- 3630 botella de expansión  
3507 tapón botella de expansión

## OPEL VECTRA-B (1996-2002)

**VECTRA-B**

**1.7 Diesel motor ISUZU X17TD**

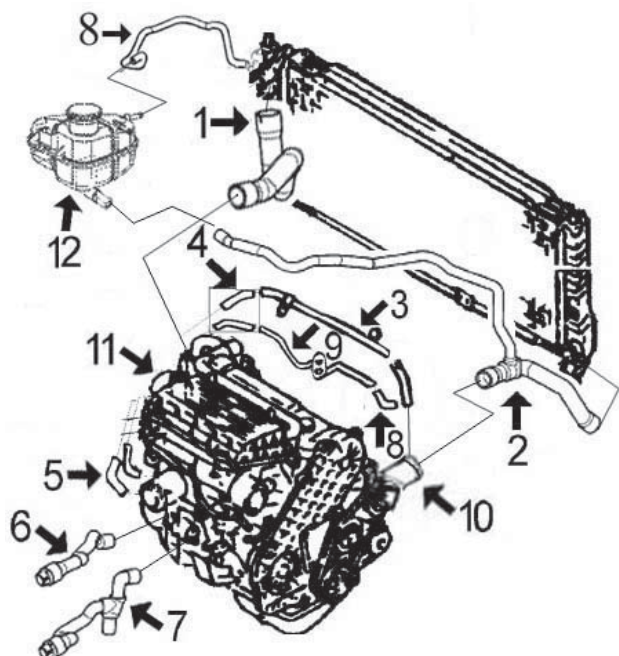

- 1- 9109 mgtto superior radiador
- 2- 9110 mgtto inferior radiador
- 3- 3069 tubo de agua metálico
- 4- 8996 jgo mgtos de tubo metálico a caja termostato
- 5- 8196 jgo mgtos intercambiador filtro de aceite
- 6- 9111 mgtto entrada a calefactor
- 7- 9112 mgtto retorno calefactor
- 8- 8115 jgo mgtos de tubo metálico a boquilla aluminio
- 9- 3161 tubo de agua metálico
- 10- 4713 boquilla aluminio en bloque motor
- 11- 3162 caja de termostato
- 12- 3630 botella de expansión
- 3507 tapón botella de expansión

8951 mgtto desvaporizador

**VECTRA-B**

**2.0 Diesel motor X20DTL**

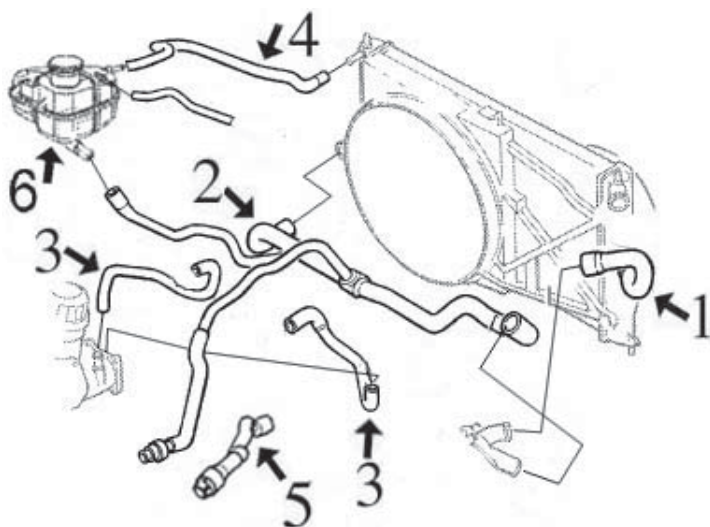

- 1- 9113 mgtto superior radiador
- 2- 9114 mgtto inferior radiador, a botella y entrada a calefactor
- 3- 9098 jgo mgtos intercambiador filtro de aceite
- 4- 9101 mgtto de sobrante de botella a radiador
- 5- 9097 mgtto retorno calefactor
- 6- 3630 botella de expansión
- 3507 tapón botella de expansión

9145 mgtto desvaporizador

VECTRA-B

2.0 Diesel motores X20DTH / Y20DTH

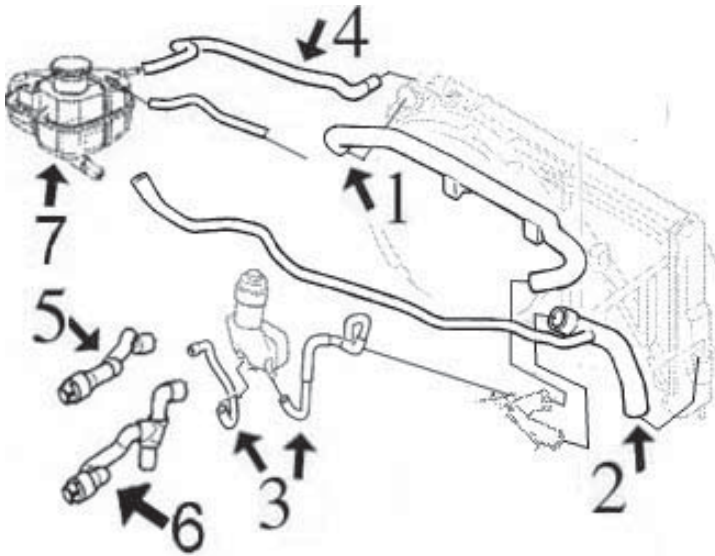

- 1- 9100 mgto superior radiador
- 2- 9099 mgto inferior radiador
- 3- 9098 jgo mgto intercambiador filtro de aceite
- 4- 9101 mgto de sobrante de botella a radiador
- 5- 9097 mgto entrada a calefactor
- 6- 9096 mgto retorno de calefactor
- 7- 3630 botella de expansión  
3507 tapón botella de expansión

9145 mgto desvaporizador



**8115**  
jgo mgto de tubo metálico a boquilla 1.7D  
r.o.



**8196**  
jgo mgto intercambiador en filtro 1.7D  
r.o.

**¡Nuevo!**



**8966**  
mgto de tubo a bomba de agua 1.6/16v  
r.o.

**¡Nuevo!**



**8996**  
jgo mgto de tubo metálico a caja termostato  
1.7D, r.o.

**¡Nuevo!**



**9096**  
mgto calefactor 2.0DTH  
r.o.

**¡Nuevo!**



**9097**  
mgto calefactor 2.0DTH  
r.o.

**¡Nuevo!**



**9098**  
jgo mgto intercambiador 2.0DTL/DTH-2.2D  
r.o.

**¡Nuevo!**



**9099**  
mgto inferior radiador 2.0DTH  
r.o.

















**¡Nuevo!**



**9100**  
mgto superior radiador 2.0DTH  
r.o.



## OPEL VECTRA-B (1996-2002)

<p><b>¡Nuevo!</b></p>  <p><b>9101</b> mgto de radiador a botella r.o.</p>	<p><b>¡Nuevo!</b></p>  <p><b>9102</b> mgto calefactor 1.6/16v r.o.</p>	<p><b>¡Nuevo!</b></p>  <p><b>9103</b> mgto calefactor 1.6/16v r.o. 6818493</p>
<p><b>¡Nuevo!</b></p>  <p><b>9104</b> mgto inferior radiador 1.6/16v r.o.</p>	<p><b>¡Nuevo!</b></p>  <p><b>9105</b> mgto superior radiador 1.6/16v r.o.</p>	<p><b>¡Nuevo!</b></p>  <p><b>9106</b> mgto de tubo a botella 1.6/16v-1.8/16v r.o.</p>
<p><b>¡Nuevo!</b></p>  <p><b>9107</b> mgto inferior radiador 1.8/16v-2.0-2.0/16v r.o. 1336155</p>	<p><b>¡Nuevo!</b></p>  <p><b>9108</b> mgto superior radiador 1.8/16v-2.0/16v r.o.</p>	<p><b>¡Nuevo!</b></p>  <p><b>9109</b> mgto superior radiador 1.7TD r.o.</p>
<p><b>¡Nuevo!</b></p>  <p><b>9110</b> mgto inferior radiador 1.7TD r.o.</p>	<p><b>¡Nuevo!</b></p>  <p><b>9111</b> mgto calefactor 1.7TD r.o.</p>	<p><b>¡Nuevo!</b></p>  <p><b>9112</b> mgto calefactor 1.7TD r.o.</p>
<p><b>¡Nuevo!</b></p>  <p><b>9113</b> mgto superior radiador 2.0DTL r.o.</p>	<p><b>¡Nuevo!</b></p>  <p><b>9114</b> mgto inferior radiador 2.0DTL r.o.</p>	
<p><b>¡Nuevo!</b></p>  <p><b>8951</b> mgto desvaporizador 1.7TD r.o. 656051</p>	<p><b>¡Nuevo!</b></p>  <p><b>9056</b> mgto desvaporizador 1.6/16v r.o. 5656071</p>	<p><b>¡Nuevo!</b></p>  <p><b>9145</b> mgto desvaporizador 2.0D-2.2D r.o. 5656075-5656042</p>

OPEL VECTRA-B (1996-2002)



**3069**  
tubo de agua metálico 1.7DT  
r.o. 1336122



**3161**  
tubo de agua metálico 1.7DT  
r.o. 1336066



**3162**  
caja de termostato 1.7DT  
r.o. 1338182-1338188

**¡Nuevo!**

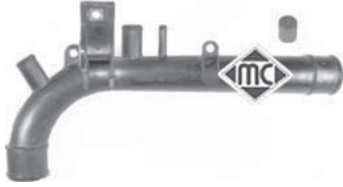

**3183**  
tubo de agua rígido 1.6/16v  
r.o.



**3507**  
tapón botella de expansión  
r.o. 1304667



**3630**  
botella de expansión  
r.o. 1304218

**¡Nuevo!**



**4713**  
boquilla aluminio en bloque motor 1.7D  
r.o.

SUSPENSION DELANTERA y SOPORTES DE MOTOR:

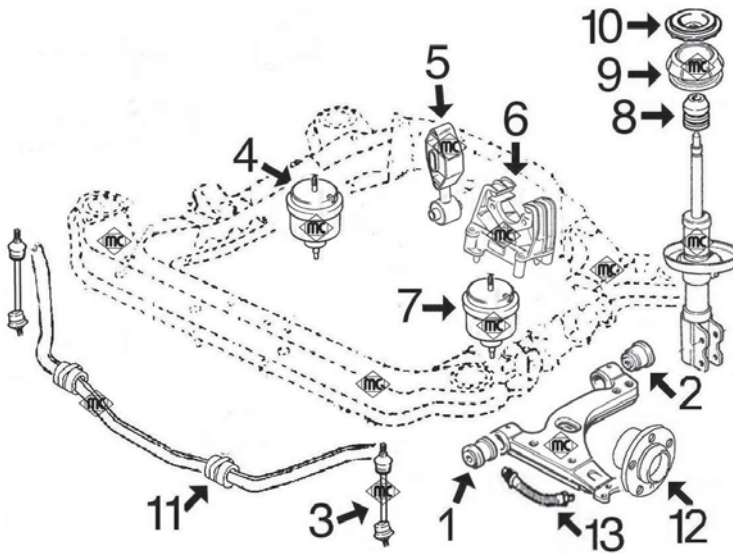

- 1- 4232 silentbloc anterior trapecio delantero
- 2- 4231 silentbloc posterior trapecio delantero
- 3- 4241 bieleta puntal barra estabilizadora
- 4- 4389 soporte motor derecho salvo 1.7TD  
4394 soporte motor derecho 1.7TD
- 5- 4234 soporte motor trasero (bieleta antipar)
- 6- 4391 soporte motor trasero
- 7- 4390 soporte motor izquierdo
- 8- 4727 juego tope poliuretano amortiguador delantero  
y capuchón amortiguador
- 9- 4214 soporte amortiguador delantero
- 10- 4313 tapa superior amortiguador con rodamiento
- 11- 4376 goma para barra estabilizadora de Ø 16 mm  
4377 goma para barra estabilizadora de Ø 18 mm
- 12- 90043 buje rueda delantera de 4 agujeros  
90055 buje rueda delantera de 5 agujeros
- 13- 96142 latiguillo freno delantero (410 mm)

SUSPENSION TRASERA:

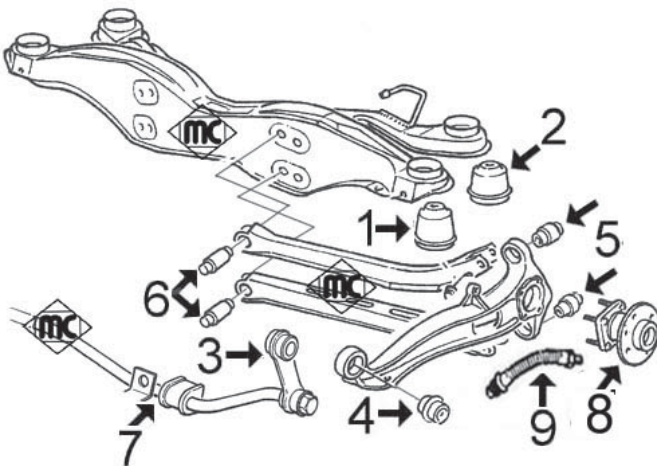

- 1- 4385 silentbloc anterior puente trasero
- 2- 4386 silentbloc posterior puente trasero
- 3- n/d bieleta puntal barra estabilizadora
- 4- 4387 silentbloc anterior portamangueta trasera
- 5- 4388 silentblocs exteriores brazo trasero (hidráulicos)
- 6- 4408 silentblocs interiores brazo trasero
- 7- n/d goma barra estabilizadora trasera
- 8- 90524 buje rueda trasera, freno sin ABS
- 9- 96159 latiguillo freno trasero (195 mm)

OPEL VECTRA-B (1996-2002)



**4214**  
soporte amortiguador delantero  
r.o. 344523-344525



**4231**  
silentbloc posterior trapecio delantero  
r.o. 3523.58



**4232**  
silentbloc anterior trapecio delantero  
r.o. 3523.57-3523.64



**4234**  
soporte motor trasero (bieleta antipar)  
r.o. 684703



**4241**  
bieleta puntal barra estabilizadora  
r.o. 350610



**4313**  
tapa con rodamiento amortiguador delt.  
r.o. 344591



**4376**  
goma para barra estabilizadora delantera  
de Ø 16 mm, r.o. 350130

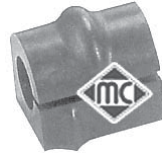

**4377**  
goma para barra estabilizadora delantera  
de Ø 18 mm, r.o. 350138



**4385**  
silentbloc anterior puente trasero  
r.o. 5402630



**4386**  
silentbloc posterior puente trasero  
r.o. 5402631



**4387**  
silentbloc anterior portamangueta trasera  
r.o. 423302-423318



**4388** **hidráulico**  
silentbloc exterior brazo trasero  
r.o. 423121



**4389**  
soporte motor derecho salvo 1.7TD  
r.o. 684674-684672



**4390**  
soporte motor izquierdo  
r.o. 684681

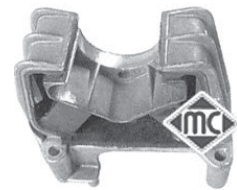

**4391**  
soporte motor trasero  
r.o. 5682508-5682507-5682512



**4394**  
soporte motor derecho 1.7TD  
r.o. 684682



**4408**  
silentbloc interior brazo transversal trasero  
r.o.

**Nuevo!**



**4727**  
juego tope poliuretano y capuchón amortiguador delantero, r.o.



**90043**  
buje rueda delantera de 4 agujeros  
r.o. 326194

























**90055**  
buje rueda delantera de 5 agujeros  
r.o. 326195



**90524**  
buje rueda trasera sin ABS  
r.o. 1604307-1604004



OPEL VECTRA-B (1996-2002)

 <p><b>96142</b> latiguillo freno delantero (410 mm) r.o.562373</p>	 <p><b>96159</b> latiguillo freno trasero (195 mm) r.o.562346</p>	  <p><b>3710</b> tapón llenado combustible r.o.0808117</p>
 <p><b>4969</b> juego casquillos palanca de cambio r.o.</p>	 <p><b>4730</b> varilla nivel aceite 1.6/16v-18/16v r.o.658048</p>	  <p><b>3674</b> tapón llenado aceite 1.8/16v-2.0/16v-2.0D-2.2D,r.o.5650831</p>
  <p><b>3683</b> tapón llenado aceite motor 1.7D r.o.650089</p>	 <p><b>4773</b> rodillo tensor correa alternador r.o.1340514</p> <p>Ø 65 mm</p>	 <p><b>5091</b> tensor correa alternador 1.6/16v-1.8/16v-2.0 con aire acond.,r.o.1304544-1340541</p>
 <p><b>4781</b> polea cigüeñal 2.0 gasolina r.o.614654</p>	 <p><b>4491</b> polea cigüeñal 2.0D-2.2D r.o.5614437</p>	 <p><b>1108</b> fuelle cremallera dirección r.o.</p>
 <p><b>1989</b> kit fuelle transm. l/rueda 1.6 r.o.374002</p>	 <p><b>1175</b> kit fuelle transm. l/rueda 1.8-2.0-1.7DT-DTL-2.0DTL,r.o.</p>	 <p><b>1490</b> kit fuelle transmisión l/cambio 1.6 r.o.374018</p>
 <p><b>1114</b> kit fuelle transm. l/cambio 1.8-2.0-2.0DTL-1.7DTL,r.o.</p>	 <p><b>2428</b> soporte tubo de escape r.o.852726</p>	 <p><b>2667</b> tapón cárter aceite todos mods. salvo TD r.o.652477</p>
 <p><b>2490</b> tapón cárter aceite TD (motor Isuzu) r.o.652492</p>	 <p><b>2823</b> soporte filtro de aire r.o.834976</p>	

OPEL VECTRA-C (2002- )

**¡Nuevo!**



**4976**  
silentbloc posterior trapezio delantero  
r.o. 352319

**¡Nuevo!**



**4977**  
bieleta puntal barra estabilizadora delantera  
r.o. 350387

**¡Nuevo!**



**4965**  
juego silentblocs brazo trasero suspensión  
r.o. (se montan en brazo r.o. 423035)

**¡Nuevo!**



**8874**  
juego manguitos TURBO motor 2.2D  
r.o. 352319

**¡Nuevo!**



**4491**  
polea cigueñal motor 2.2D  
r.o. 614411

**¡Nuevo!**



**1175**  
kit fuelle transmisión lado rueda  
r.o.



**2428**  
soporte tubo escape  
r.o. 852726

**SUSPENSION DELANTERA y SOPORTES de MOTOR:**

motores 1.9D (F9Q), 2.5D (G9U) y 2.0-16v (F4R)

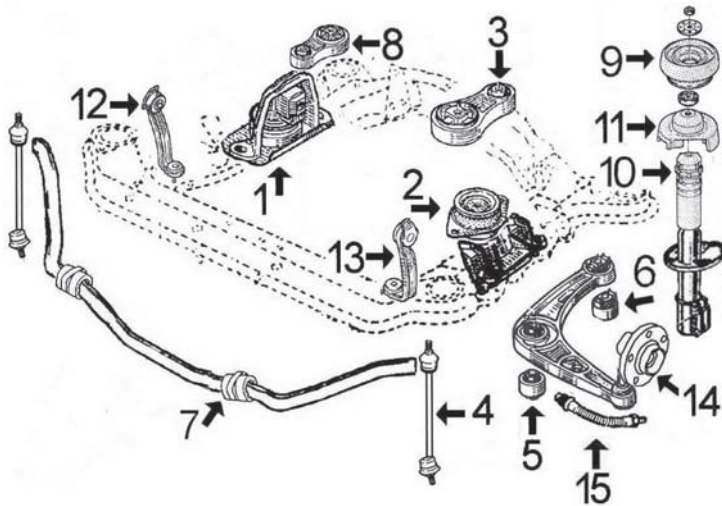





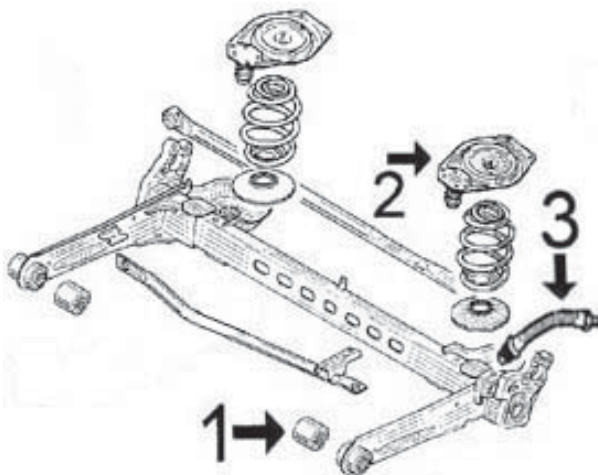



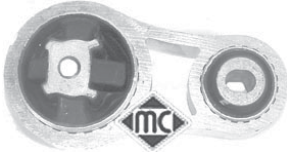

- 1- 4453 soporte motor derecho 1.9D y 2.0-16v
- 4450 soporte motor derecho 2.2D y 2.5D
- 2- 4451 soporte motor izquierdo 1.9D y 2.0-16v
- 4447 soporte motor izquierdo 2.5D
- 3- 4452 soporte motor trasero 1.9D y 2.0-16v
- 4449 soporte motor trasero 2.5D
- 4- 4457 bieleta puntal barra estabilizadora
- 5- 4487 silentbloc anterior trapecio delantero
- 6- 4488 silentbloc posterior trapecio delantero
- 7- n/d goma barra estabilizadora
- 8- 4448 bieleta antipar en soporte motor derecho todos
- 9- 4456 soporte amortiguador completo con rodamiento
- 10- 4589 capuchón amortiguador delantero
- 11- 4590 cazoleta superior muelle delantero
- 12- n/d soporte derecho subchasis delantero
- 13- n/d soporte izquierdo subchasis delantero
- 14- 90095 buje rueda delantera
- 15- 96204 latiguillo freno delantero (415 mm)

**SUSPENSION TRASERA**















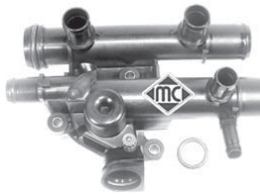









- 1- 4454 silentbloc puente trasero
- 2- n/d soporte amortiguador trasero
- 3- 96205 latiguillo freno trasero (230 mm)

## OPEL VIVARO (2001- )

<p><b>iNuevo!</b></p>  <p><b>4447</b> soporte motor izquierdo 2.5D r.o.</p>	<p><b>iNuevo!</b></p>  <p><b>4448</b> tirante reacción en soporte motor derecho r.o.</p>	<p><b>iNuevo!</b></p>  <p><b>4449</b> soporte motor trasero 2.5D r.o.</p>
<p><b>iNuevo!</b></p>  <p><b>4450</b> soporte motor derecho 2.5D r.o.</p>	<p><b>iNuevo!</b></p>  <p><b>4451</b> soporte motor izquierdo 1.9D y 2.0-16v r.o.</p>	<p><b>iNuevo!</b></p>  <p><b>4452</b> soporte motor trasero 1.9D y 2.0-16v r.o.</p>
<p><b>iNuevo!</b></p>  <p><b>4453</b> soporte motor derecho 1.9D y 2.0-16v r.o.</p>	<p><b>iNuevo!</b></p>  <p><b>4454</b> silentbloc puente trasero r.o.</p>	<p><b>iNuevo!</b></p>  <p><b>4456</b> soporte amortiguador completo con rodam. r.o.</p>
<p><b>iNuevo!</b></p>  <p><b>4457</b> bieleta puntal barra estabilizadora r.o.</p>	<p><b>iNuevo!</b></p>  <p><b>4487</b> silentbloc anterior trapecio delantero r.o.</p>	<p><b>iNuevo!</b></p>  <p><b>4488</b> silentbloc posterior trapecio delantero r.o.</p>
<p><b>iNuevo!</b></p>  <p><b>4589</b> capuchón amortiguador delantero r.o.</p>	<p><b>iNuevo!</b></p>  <p><b>4590</b> cazoleta apoyo superior muelle delantero r.o.</p>	<p><b>iNuevo!</b></p>  <p><b>90095</b> bujе rueda delantera r.o.</p>
<p><b>iNuevo!</b></p>  <p><b>96204</b> latiguillo freno delantero (415 mm) r.o. 8200404264</p>	<p><b>iNuevo!</b></p>  <p><b>96205</b> latiguillo freno trasero (230 mm) r.o. 82000003480</p>	



## OPEL VIVARO (2001- )

<p><b>3645</b>  <b>89°</b> caja con termostato completa 1.9D (89°) r.o. 8200074346</p>	<p><b>3661</b>  <b>83°</b> caja con termostato completa 1.9D (83°) r.o. 8200074349</p>	<p><b>3646</b>  caja de termostato completa 2.5D, 83° r.o. 8200262237-8200262241-8200154296</p>
<p><b>3119</b>  tapa de termostato 2.0-16v r.o. 7700869797</p>	<p><b>3563</b>  tapón botella de expansión r.o. 7700805131</p>	<p><b>3664</b>  botella de expansión r.o.</p>
<p><b>4464</b>  <b>6 canales</b> polea cigueñal motor F4R 2.0-16v r.o. 8200276838</p>	<p><b>4611</b>  <b>7 canales</b> polea cigueñal motor F4R 2.0-16v r.o. 8200276840-8200451073</p>	<p><b>4736</b>  <b>7 canales</b> polea cigueñal motor F4R 2.0-16v r.o. 7700116269-8200386453</p>
<p><b>4455</b>  <b>6 canales</b> polea cigueñal 1.9 Diesel r.o. 8200079183</p>	<p><b>4666</b>  <b>7 canales</b> polea cigueñal 1.9 Diesel r.o. 8200297937</p>	<p><b>4463</b>  <b>7 canales</b> polea cigueñal 2.2/2.5 Diesel r.o. 8200213058</p>
<p><b>4585</b>  <b>7 canales</b> polea cigueñal 2.2/2.5 Diesel r.o. 8200207435</p>	<p><b>4724</b>  varilla nivel aceite motor 2.5 Diesel r.o. 8200086256</p>	<p><b>4725</b>  varilla nivel aceite motor 1.9D y 2.0 r.o. 8200138515</p>
<p><b>3617</b>   tapón llenado aceite motor r.o. 8200096805</p>	<p><b>4641</b>  <b>desembragable</b> jgo. tapas árboles de levas 2.0-16v r.o. 7700106271+7700274026</p>	<p><b>4728</b>  <b>sólida</b> polea alternador <b>5 canales</b> r.o.</p>
<p><b>4729</b>  <b>sólida</b> polea alternador <b>6 canales</b> r.o.</p>	<p><b>4947</b>  <b>desembragable</b> polea alternador <b>5 canales</b> r.o. 8200113636</p>	<p><b>4948</b>  <b>desembragable</b> polea alternador <b>6 canales</b> r.o. 7700110616</p>

## OPEL VIVARO (2001- )

<p><b>¡Nuevo!</b></p>  <p><b>4912</b> Ø 61,00 mm polea de alternador de rueda libre r.o.</p>	<p><b>¡Nuevo!</b></p>  <p><b>4913</b> Ø 53,30 mm polea de alternador de rueda libre r.o.</p>	<p><b>¡Nuevo!</b></p>  <p><b>4914</b> Ø 55,40 mm polea de alternador de rueda libre r.o.</p>
 <p><b>1520</b> kit fuelle transmisión lado rueda r.o. 7701473176</p>	 <p><b>2304</b> rodamiento de Ø 28.0 mm kit fuelle transmisión izquierda l/cambio (Ø exterior boca grande 114 mm)</p>	<p><b>¡Nuevo!</b></p>  <p><b>1139</b> rodamiento de Ø 28.0 mm kit fuelle transmisión izquierda l/cambio (Ø exterior boca grande 105 mm)</p>
<p><b>¡Nuevo!</b></p>  <p><b>1135</b> kit fuelle transmisión derecha l/cambio r.o. 7701470910</p>	 <p><b>1107</b> fuelle cremallera dirección r.o. 7701473334</p>	<p><b>¡Nuevo!</b></p>  <p><b>4717</b> cubrepedal freno y embrague r.o. 7700416724-8200183752</p>
 <p><b>667</b> tapón cárter de aceite 1.9D r.o. 7703075210</p>	 <p><b>670</b> tapón cárter de aceite 2.0-16v y 2.5D r.o. 7903075033</p>	<p><b>¡Nuevo!</b></p>  <p><b>4474</b> soporte tubo de escape todos mods. r.o.</p>
<p><b>¡Nuevo!</b></p>  <p><b>9095</b> mgto desvaporizador con válvula 1.9Diesel r.o. 8200063371-8200136128</p>	<p><b>¡Nuevo!</b></p>  <p><b>3714</b> decantador completo 2.0 gasolina r.o.</p>	<p><b>¡Nuevo!</b></p>  <p><b>3717</b> decantador completo 1.9Diesel r.o.</p>
<p><b>¡Nuevo!</b></p>  <p><b>4994</b> polea árbol de levas 1.9DTi-DCi (F9Q) r.o. 7700866844-7700107401</p>		

CANALIZACIONES DE AGUA

106 - motores TU 954cc (TU9) y 1124cc (TU1)

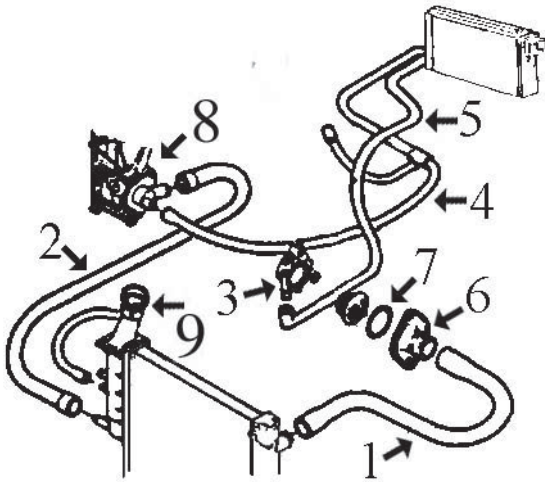

- 1- 7854 mgto superior radiador
- 2- 7834 mgto inferior radiador
- 3- 3082 boquilla metálica superior en caja termostato  
3081 boquilla metálica inferior en caja termostato
- 4- 8531 mgto derecho calefactor, 1er. tramo  
8343 mgto derecho de calefactor, 2º tramo
- 5- 7817 mgto de calefactor a caja termostato
- 6- 3011 boquilla alojamiento termostato
- 7- 2351 junta de termostato
- 8- 3578 tapa bomba de agua hasta '96  
3641 tapa bomba de agua desde '96
- 9- 3548 tapón radiador 1.4 bar

- 8167 mgto desvaporizador 1.1
- 8002 mgto desvaporizador 1.1

106 - motores 1.4 (TU3M - TU3J) y 1.6 (TU5JP - TU5JP2)

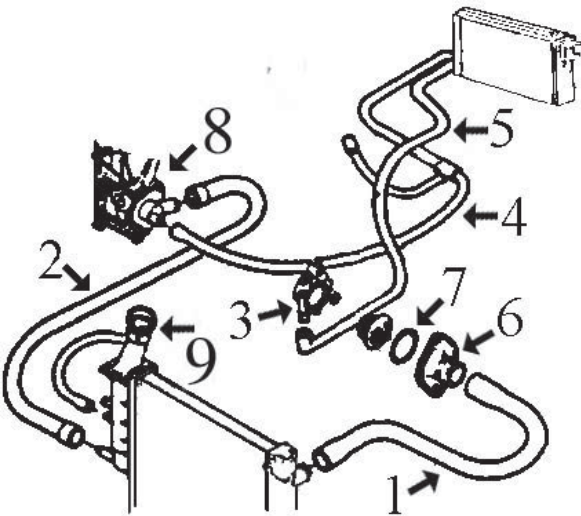

- 1- 7854 mgto superior radiador, versiones sin intercambiador en el filtro de aceite  
8525 mgto superior radiador, versiones con intercambiador en el filtro de aceite
- 2- 7834 mgto inferior radiador hasta '94  
8532 mgto inferior radiador desde '94
- 3- 3082 boquilla metálica superior en caja termostato  
3081 boquilla metálica inferior en caja termostato
- 4- 8531 mgto derecho calefactor, 1er. tramo  
8343 mgto derecho de calefactor, 2º tramo 1.4 carbur.  
8530 mgto derecho calefactor, 2º tramo 1.4i y 1.6
- 5- 7817 mgto de calefactor a caja termostato 1.4  
8534 mgto de calefactor a caja termostato 1.6
- 6- 3011 boquilla alojamiento termostato hasta '99  
3611 tapa con termostato desde '99
- 7- 2351 junta de termostato
- 8- 3578 tapa bomba de agua hasta '96  
3641 tapa bomba de agua desde '96
- 9- 3548 tapón radiador 1.4 bar

- 8541 mgto desvaporizador 1.4
- 8542 mgto desvaporizador 1.4

106 - 1.3 "Rallye" (motor TU2J2)

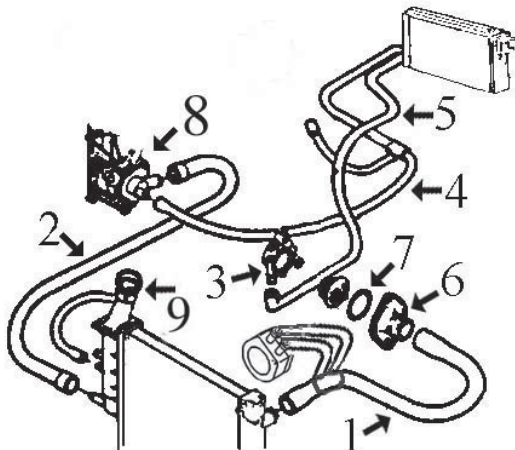

- 1- 8525 mgto superior radiador
- 2- 8532 mgto inferior radiador
- 3- 3082 boquilla metálica superior en caja termostato  
3081 boquilla metálica inferior en caja termostato
- 4- 8531 mgto derecho calefactor, 1er. tramo  
8530 mgto derecho de calefactor, 2º tramo
- 5- 7817 mgto de calefactor a caja termostato
- 6- 3011 boquilla alojamiento termostato
- 7- 2351 junta de termostato
- 8- 3578 tapa bomba de agua
- 9- 3548 tapón radiador 1.4 bar



106 - 1.4 DIESEL (motor TUD3)

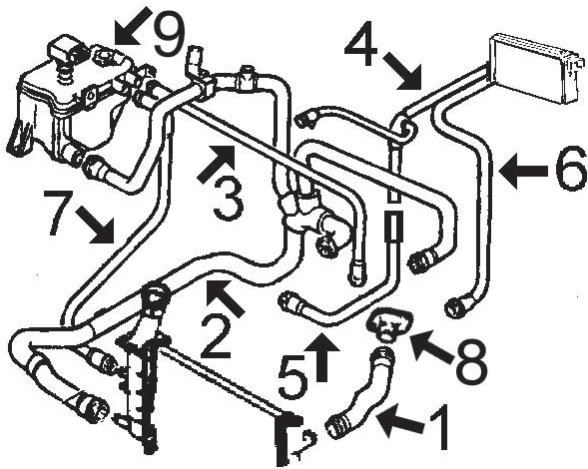

- 1- 8522 mgto superior radiador
- 2- 8322 mgto inferior radiador
- 3- 8323 mgto de botella a caja de termostato
- 4- 8061 mgto derecho de calefactor, 1er. tramo
- 5- 8329 mgto derecho de calefactor, 2º tramo
- 6- 8075 mgto izquierdo de calefactor
- 7- 8323 mgto de botella a radiador
- 8- 3132 tapa de termostato
- 3077 boquilla en caja termostato
- 3078 boquilla en caja termostato
- 9- 3643 botella de expansión
- 3548 tapón botella expansión 1.4 bar

8324 mgto desvaporizador

106 - 1.5 DIESEL (motor TUD5)

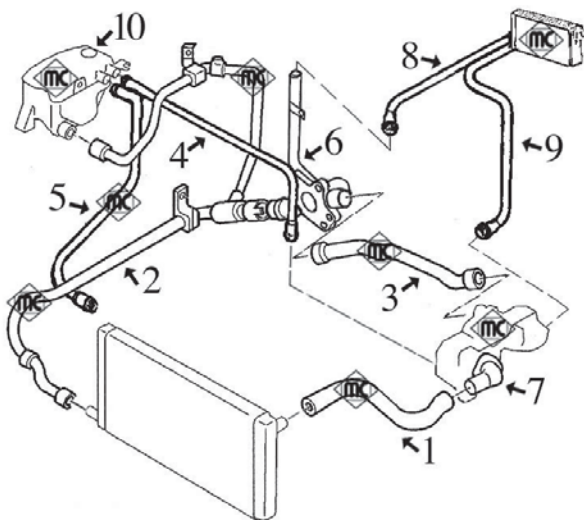

- 1- 8521 mgto superior radiador
- 2- 8515 mgto inferior radiador
- 3- 8511 mgto de tubo metálico a caja termostato
- 4- 8510 mgto de botella a caja termostato
- 5- 8517 mgto de botella a radiador
- 6- 3133 tubo de agua metálico
- 7- 3550 tapa de termostato
- 3077 boquilla en caja termostato
- 3078 boquilla en caja termostato
- 8- 8513 mgto de calefactor a tubo metálico
- 9- 8514 mgto de calefactor a caja termostato
- 10- 3643 botella de expansión
- 3548 tapón botella expansión 1.4 bar

106 - 1.5 Diesel, desvaporizadores:

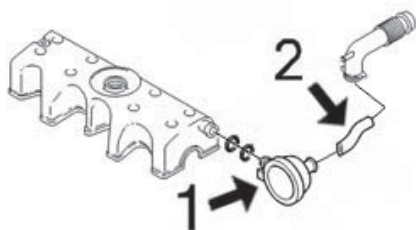

- 1- 3655 válvula desvaporizadora con juntas tóricas
- 2- 8533 mgto de válvula desvaporizadora a filtro aire



PEUGEOT 106

 <p><b>7817</b> mgto de caja termostato a calefactor gasolina, r.o. 6464.JN</p>	 <p><b>7834</b> mgto inferior radiador gasolina r.o. 1343.G0</p>	 <p><b>7854</b> mgto superior radiador gasolina r.o. 1343.F8</p>
 <p><b>7941</b> mgto derecho calefactor, 1er. tramo r.o. 6464.FT</p>	 <p><b>8002</b> mgto desvaporizador gasolina r.o. 1191.13-1191.21-1192.62</p>	 <p><b>8042</b> mgto superior radiador Diesel r.o. 1343.H2</p>
 <p><b>8061</b> mgto derecho de calefactor Diesel, 1er. tramo, r.o. 6464.R8</p>	 <p><b>8075</b> mgto izquierdo de calefactor Diesel r.o. 6464.R9</p>	 <p><b>8167</b> mgto desvaporizador gasolina r.o. 1192.69-1192.61</p>
 <p><b>8322</b> mgto inferior radiador 1.4 Diesel r.o. 1351.T5</p>	 <p><b>8323</b> mgto de botella a radiador 1.4 Diesel r.o. 1351.F0</p>	 <p><b>8324</b> mgto desvaporizador 1.4 Diesel r.o. 1192.C6</p>
 <p><b>8329</b> mgto derecho de calefactor Diesel, 2º tramo r.o. 6464.R7</p>	 <p><b>8343</b> mgto derecho calefactor gasolina 2º tramo r.o. 6464.L3</p>	 <p><b>8510</b> mgto de botella a caja termostato 1.5D r.o.</p>
 <p><b>8511</b> mgto de tubo metálico a caja termostato r.o.</p>	 <p><b>8513</b> mgto de calefactor a tubo metálico r.o.</p>	 <p><b>8514</b> mgto de calefactor a caja termostato r.o.</p>
 <p><b>8515</b> mgto inferior radiador 1.5 D r.o.</p>	 <p><b>8517</b> mgto de botella a radiador 1.5 D r.o.</p>	 <p><b>8521</b> mgto superior radiador 1.5 D r.o.</p>

PEUGEOT 106



**8522**  
mgto superior radiador 1.4 Diesel  
r.o.



**8525**  
mgto superior radiador 1.4-1.6  
r.o.



**8530**  
mgto calefactor 1.4-1.6  
r.o.



**8531**  
mgto calefactor 0.9-1.1, 1er. tramo  
r.o.



**8532**  
mgto inferior radiador 1.4-1.6 desde '94  
r.o.



**8533**  
mgto desvaporizador 1.5 Diesel  
r.o.



**8534**  
mgto calefactor a caja termostato 1.6  
r.o.



**8541**  
mgto desvaporizador 1.4  
r.o.



**8542**  
mgto desvaporizador 1.4  
r.o.



**2351 gasolina**  
juntas de termostato  
r.o. 1340.30 - 1306-29

**2352 Diesel**



**3011**  
boquilla alojamiento hasta '99  
r.o. 1336.44



**3081** Ø 15,5 mm  
boquilla en caja termostato gasolina  
r.o.



**3082** Ø 10 mm  
boquilla en caja termostato gasolina  
r.o. no hay despiece



**3078**  
boquilla en caja termostato Diesel  
r.o. 1342.04



**3077** Ø 20 mm  
boquilla en caja termostato Diesel  
r.o. 1338.21



**3132**  
tapa de termostato 1.4 Diesel  
r.o. 1336.C2



**3133**  
tubo de agua metálico 1.5 Diesel  
r.o. 1204.38



**3548**  
tapón radiador / botella expansión 1.4 bar  
r.o. 1306.C7-1306.84



**3550**  
tapa de termostato 1.5 Diesel  
r.o. 1336.L2-1336.K2



**3578**  
tapa bomba de agua 1.1-1.4 TU hasta '96  
r.o. 1201.66



**3611**  
tapa con termostato 1.1-1.4-1.6 desde '99  
r.o. 1336.Q2

PEUGEOT 106

**¡Nuevo!**



**3641**

tapa bomba de agua motor 1.1-1.3TU d/ '96  
r.o. 1201.C2+1206.96

**¡Nuevo!**



**3643**

botella de expansión 1.4D - 1.5D  
r.o. 1307.V1

**¡Nuevo!**



**3655**

válvula desvaporizadora 1.5Diesel con jun-  
tas tóricas, r.o. 0361.C7+0326.21

**SUSPENSION DELANTERA y SOPORTES DE MOTOR:**

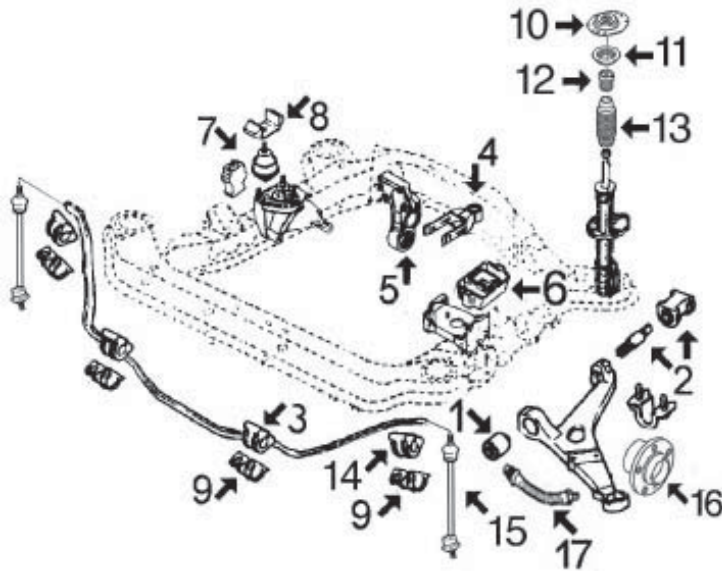

- 1- 2387 silentbloc anterior trapecio delantero salvo GTi  
2970 silentbloc anterior trapecio delantero GTi
- 2- 2386 silentbloc posterior trapecio delantero (juego completo con eje pasador)
- 3- 2989 goma para barra estabiliz. de Ø 18 mm  
2388 goma para barra estabiliz. de Ø 19 mm  
2389 goma para barra estabiliz. de Ø 21 mm  
2990 goma para barra estabiliz. de Ø 22 mm
- 4- 4746 tirante de motor trasero completo 1.0.1.1-1.4.1.6  
4744 tirante de motor trasero completo 1.4D-1.5D  
877 silentbloc del tirante trasero de motor
- 5- 2666 soporte trasero de motor (completo)  
4064 silentbloc del soporte trasero motor
- 6- 531 soporte izquierdo motor 0.9-1.1-1.4-1.6  
2786 soporte izquierdo motor 1.5 Diesel y automáticos
- 7- 2784 soporte derecho de motor 0.9-1.1  
697 soporte motor derecho 1.4-1.6 y Diesel hasta '95  
2959 soporte dcho. de motor 1.4-1.6 y 1.5 D desde '95
- 8- 724 limitador soporte motor derecho hasta '95  
2960 limitador soporte derecho motor desde '95
- 9- n/d abrazadera barra estabilizadora
- 10- 2730 soporte sup. amortiguador delantero hasta '94  
2967 soporte sup. amortiguador delantero desde '94
- 11- 4181 rodamiento soporte suspensión
- 12- 2991 tope poliuretano suspensión 1.0-1.1 (66 mm)  
4037 tope poliuretano suspensión 1.3-1.6 y D (90mm)
- 13- 2974 capuchón amortiguador
- 14- 2701 goma puntal barra estabiliz. de Ø 19 mm  
2702 goma puntal barra estabiliz. de Ø 21 mm
- 15- 2968 bieleta puntal barra estabilizadora 1.6-VTS
- 16- 90044 buje rueda delantera de 3 agujeros  
90013 buje rueda delantera de 4 agujeros hasta '96  
90045 buje rueda delantera de 4 agujeros desde '96
- 17- 96046 latiguillo freno delantero rueda de 3 agujeros  
96180 latiguillo freno delantero rueda de 4 agujeros



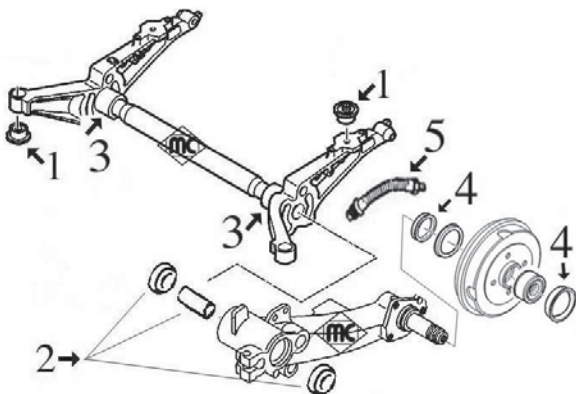









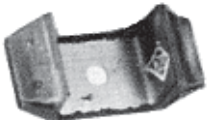
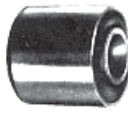
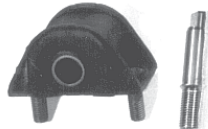





**SUSPENSION TRASERA:**



- 1- 2838 silentbloc soporte puente trasero
- 2- 4563 juego de rodamientos, retenes y casquillos brazo trasero
- 3- 4499 eje de brazo trasero (derecho e izquierdo)
- 4- 4828 juego retén eje trasero y tapón tambor
- 5- 96023 latiguillo freno trasero 220 mm



## PEUGEOT 106

 <p><b>531</b> soporte motor izquierdo 1.1-1.4-1.6 r.o. 1843.95</p>	 <p><b>697</b>      <b>HIDRAULICO (650g.)</b> soporte motor derecho 1.4 y D hasta '95 r.o. 1844.72-1844.38</p>	 <p><b>697/1</b>      <b>no hidráulico(460g.)</b> soporte motor derecho 1.4 y D hasta '95 r.o. --</p>
 <p><b>724</b> limitador soporte motor derecho hasta '95 r.o. 1844.25</p>	 <p><b>877</b> silentbloc tirante posterior motor r.o. 1809.22</p>	 <p><b>2386 completo</b>      <b>2386/1 sin eje</b> silentbloc posterior trapecio delantero r.o. 3523.51+3522.44</p>
 <p><b>2387</b> silentbloc anterior trapecio delantero r.o. 3523.50</p>	 <p><b>2388</b> goma central para barra estabiliz. 19mm r.o. 5094.56</p>	 <p><b>2389</b> goma central para barra estabiliz. 21 mm r.o. 1844.54</p>
 <p><b>2666</b> soporte motor trasero completo r.o. 1844.54</p>	 <p><b>2701</b>      <b>negra</b> goma puntal barra estabilizadora 19 mm r.o. 5094.59</p>	 <p><b>2702</b>      <b>blanca</b> goma puntal barra estabilizadora 21 mm r.o. 5094.60</p>
 <p><b>2730</b> soporte amortiguador hasta '94 r.o. 5038.08</p>	 <p><b>2784</b> soporte motor derecho 0.9 - 1.1 r.o. 1843.99</p>	 <p><b>2786</b> soporte motor izquierdo Diesel y auto- máticos, 1844.34</p>
 <p><b>2838</b> silentbloc puente trasero r.o. 5131.63</p>	 <p><b>2959</b> soporte motor derecho 1.4-1.6-1.5D, <b>hidráulico</b>, r.o. 1844.58-1844.60</p>	 <p><b>2960</b> limitador soporte motor dcho. 1.4-1.6-1.5D r.o. 1844.59</p>
 <p><b>2967</b> soporte amortiguador delantero desde '94 r.o. 5038.15</p>	 <p><b>2968</b> bieleta puntal barra estabilizadora VTS r.o. 5087.40</p>	 <p><b>2970</b> silentbloc anterior trapecio delantero VTS r.o. 3523.52</p>

PEUGEOT 106



**2974**  
capuchón amortiguador delantero  
r.o.5254.18



**2989**  
goma para barra estabilizadora de 18 mm  
r.o.5094.72



**2990**  
goma para barra estabilizadora de 22 mm  
r.o.5094.71



**2991** altura 66 mm  
tope poliuretano suspensión delantera  
r.o.5033.35



**4037** altura 90 mm  
tope poliuretano suspensión delantera  
r.o.5033.36



**4064**  
silentbloc soporte motor trasero  
r.o.



**4181**  
rodamiento soporte suspensión delantera  
r.o.5035.23

**¡nuevo!**



**4499**  
eje brazo trasero (derecho e izquierdo)  
r.o. no existe despiece en origen

**¡nuevo!**



**4563**  
juego rodamientos, retenes y casquillos  
en eje brazo trasero, r.o.

**¡nuevo!**



**4744**  
tirante de motor trasero 1.4D - 1.5D  
r.o.

**¡nuevo!**



**4746**  
tirante de motor trasero 0.9-1.1-1.4-1.6  
r.o.

**¡nuevo!**



**4828**  
juego retén eje trasero y tapón tambor  
r.o.3724.24+3740.19



**90044**  
buje rueda delantera de 3 agujeros  
r.o.3307.74



**90013**  
buje rueda delantera de 4 agujeros hasta  
'96(Ø129mm),r.o.3307.49



**90045**  
buje rueda delantera de 4 agujeros desde  
'96(Ø130mm),r.o.3307.76

**¡nuevo!**



**96046**  
latiguillo freno delantero (355 mm), rueda de  
3 agujeros, r.o.4806.55



**96180**  
latiguillo freno delantero (325 mm), rueda de  
4 agujeros, r.o.4806.56-4806.61-4806.81







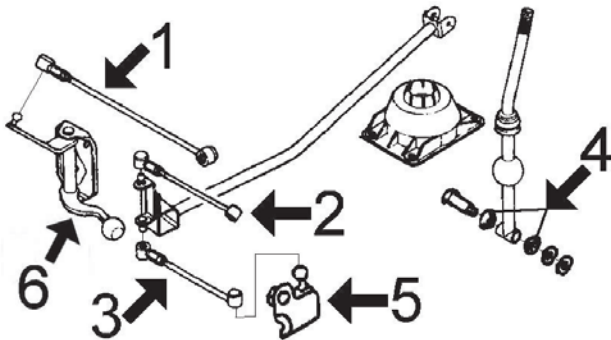





**96023**  
latiguillo freno trasero (220 mm)  
r.o.4806.75-4806.61

ARTICULACIONES PALANCA DE CAMBIO:

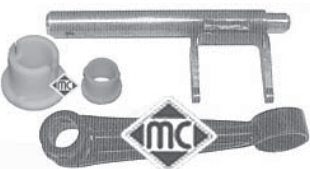

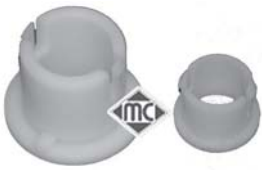
- 1- 2377 bieleta selección cambio velocidades
- 2- 2376 bieleta selección cambio velocidades
- 3- 2375 bieleta selección cambio velocidades
- 4- 2400 casquillo palanca de cambio
- 5- 2396 soporte bieleta inferior
- 6- 4988 articulación reenvío cambio









<p>long. máx. 190 mm long. mín. 175 mm rótulas de Ø 10 mm</p>  <p><b>2375</b> bieleta inferior mando cambio r.o.95636573</p>	<p>long. máx. 190 mm long. mín. 175 mm rótulas de Ø 10 mm</p>  <p><b>2376</b> bieleta central mando cambio r.o.95631090</p>	<p>rótulas de Ø 13 mm</p>  <p><b>2377</b> bieleta superior mando cambio r.o.2452.69</p>
 <p><b>2396</b> soporte bieleta inferior mando cambio r.o.2163.08</p>	 <p><b>2400</b> casquillo palanca cambio r.o.95634960</p>	<p><i>¡Nuevo!</i></p>  <p><b>4988</b> articulación reenvío cambio r.o.2449.65</p>
 <p><b>4300</b> horquilla embrague completa con casquillos r.o.2117.52</p>	<p><i>¡Nuevo!</i></p>  <p><b>4424</b> altura 55,50 mm casquillo guía embrague hasta '96 r.o.2105.14</p>	<p><i>¡Nuevo!</i></p>  <p><b>4796</b> altura 56,50 mm casquillo guía embrague desde '96 r.o.2105.38</p>
 <p><b>4057</b> juego casquillos horquilla embrague r.o.2175.11+2175.12</p>	 <p><b>2335</b> varilla nivel aceite TU-0.9-1.1-1.4-1.6 y 1.4D hasta '96, r.o. 1174.10-1174.49</p>	<p><i>¡Nuevo!</i></p>  <p><b>4593</b> varilla nivel aceite TU-1.1-1.4-1.6 desde '96 r.o.</p>

PEUGEOT 106

<p><b>4595</b> varilla nivel aceite 1.5 Diesel (TUD5) r.o. 1174.23</p> 	<p><b>3639</b> tapón llenado aceite motores TU todos de gasolina (salvo 1.6-16v), r.o.</p> 	<p><b>1609</b> fuelle cremallera dirección hasta '96 r.o. 4066.36</p> 
<p><b>904</b> capuchón izquierdo cremallera dirección r.o. 4066.32</p> 	<p><b>1064</b> fuelle cremallera asistida desde '96 r.o. 4066.50</p> 	<p><b>2911</b> silentbloc pistón cremallera asistida r.o. 4059.10(12x24x20x24)</p> 
<p><b>2401</b> casquillo cremallera dirección r.o.</p> 	<p><b>4439</b> 5 canales Ø 138 mm polea cigueñal 1.6 (TU5) sin a/a r.o. 0515.K8</p> 	<p><b>4460</b> 5 canales Ø 128 mm polea cigueñal 1.6 (TU5) con a/a r.o. 0515.J3</p> 
<p><b>2958</b> 5 canales Ø 142 mm polea cigueñal 1.5 Diesel r.o. 0515.L6</p> 	<p><b>3697</b> juego tapas correa distribución 1.1TU-1.4TU r.o. 0320.S2+0320.L3</p> 	<p><b>3696</b> juego tapas correa distribución 1.5D r.o. 0320.K6+0320.P5</p> 
<p><b>4036</b> bomba cebado manual Diesel con válvula antirretorno y boquilla adicional a 90°</p> 	<p><b>4564</b> Ø 30/47 y 40/58 mm juego retenes diferencial-transmisiones r.o. 3121.44+3124.46</p> 	<p><b>1532</b>      <b>1532E (cono)</b> kit rep. transm. l/rda 1.1 hasta '96 r.o. 3293.81</p> 
<p><b>1710</b>      <b>1710E (cono)</b> kit rep. transm. l/rda 1.4-1.6 hasta '93 r.o. 3293.77</p> 	<p><b>1521</b> kit rep. transm l/rda 1.4 desde '93 hasta '96 y 1.6 desde '93, r.o. 3293.05</p> 	<p><b>1433</b> kit fuelle tr. izquierda l/rda 1.1-1.4 y 1.5D desde '96, r.o.</p> 
<p><b>1218</b> kit fuelle trans. derecha l/rda 1.1 desde '96 r.o. 3293.11</p> 	<p><b>1434</b> kit fuelle tr. derecha l/rda 1.4-1.5 r.o.</p> 	<p><b>1606</b> kit rep. transmisión l/cambio 0.9-1.1 r.o. 3287.75</p> 



## PEUGEOT 106

 <p><b>1533</b> kit rep. transmisión/cambio 1.4-1.5 D r.o. 3287.69</p>	 <p><b>2973</b>      <b>junta de Ø 60 x 48 mm</b> kit montaje colector escape 1.5 Diesel r.o. 1798.45</p>	 <p><b>2964</b>      <b>junta de Ø 63 x 48 mm</b> kit montaje colector escape 1.6 y Rallye r.o. 1798.65</p>
 <p><b>2392</b>      <b>junta de Ø 60 x 46 mm</b> kit montaje colector escape 1.4 y 1.4 D r.o. 1798.76</p>	 <p><b>2692</b> soporte anterior tubo escape 1.1-1.4-1.6 r.o. 1755.66</p>	 <p><b>2417</b> soporte posterior tubo escape todos r.o. 1755.44</p>
 <p><b>2965</b> soporte anterior tubo escape 1.5D r.o. 1755.70</p>	 <p><b>2773</b> cubrepedal freno y embrague r.o. 2130.14</p>	 <p><b>667</b> tapón cárter aceite 16x150, 1.1-1.4-1.6 r.o. 0163.93</p>
 <p><b>2452</b> tapón cárter de aceite 14x125, 1.5 Diesel r.o. 0311.21</p>	 <p><b>942</b> funda protectora Delco r.o. 5966.16</p>	

CANALIZACIONES DE AGUA

205 motores 1118 (E1), 1124 (F1), 1294 (G1), 1442 (Y2) y 1592 cc (J2):

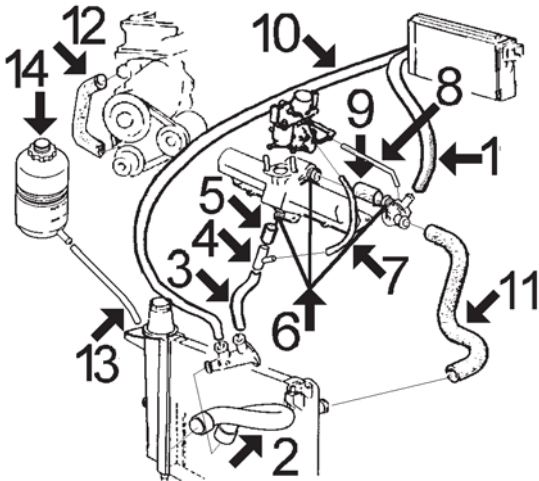

- 1- 7559 mgto superior radiador
- 2- 7561 mgto inferior radiador
- 3- 7655 mgto de racor entrada a racor intermedio
- 4- n/d racor enlace maguitos
- 5- 7582 mgto de racor intermedio a colector
- 6- n/d racores en colector y caja de termostato
- 7- 7952 mgto de racor intermedio a carburador
- 8- 7952 mgto de carburador a caja termostato
- 9- 7581 mgto de colector a caja termostato
- 10- 7751 mgto de calefactor a racor entrada agua
- 11- 7660 mgto de calefactor a caja termostato
- 12- 7708 mgto de bomba de agua a tapa
- 13- 117 mgto de botella a radiador: Cortar de rollo MC-117 Ø 10x17 mm, long. aprox. 130 cms.
- 14- 3501 botella de expansión
- 3519 tapón botella expansión 0,7 bar
- 3524 tapón botella expansión 1,0 bar

MGTOS DESVAPORIZADORES:

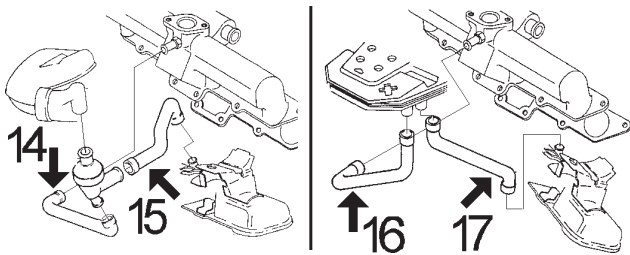

- 14- 8002 tubo de filtro regulador a colector 1118-1124 y 1294 cc (motores E1, F1 y G1)
- 15- 8001 tubo de filtro regulador a tapa balancines 1118-1124 y 1294 cc (motores E1, F1 y G1)
- 16- 8004 tubo de filtro de aire a colector 1442 y 1592 cc (motores Y2 y J2)
- 17- 8003 tubo de filtro de aire a tapa de balancines 1442 y 1592 cc (motores Y2 y J2)

205 y 309 motores TU de 1124 cc (TU1) y 1360 cc (TU3S y TU24 "Rallye"), desde 1991:

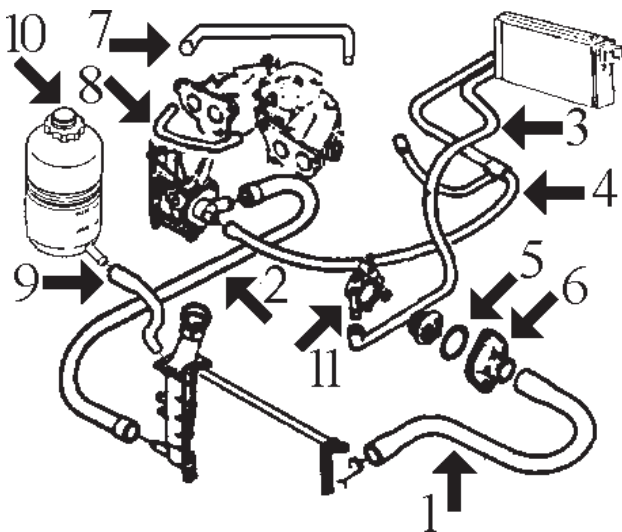

- 1- 7888 mgto superior radiador 205 (radiador metálico)
- 8686 mgto superior radiador 309
- 7745 mgto superior radiador 205 (radiador de plástico) y 309 con aire acondicionado
- n/d mgto superior radiador 205 "Rallye" (4 vias)
- 2- 7746 mgto inferior de radiador
- 3- 8178 mgto de calefactor a termostato, salvo "Rallye"
- 4- 8177 mgto de calefactor a bomba, 3 vias con purgador
- 5- 2351 junta de termostato
- 6- 3011 boquilla alojamiento termostato
- 7- 7952 mgto de carburador a colector (\*)
- 8- 7953 mgto de carburador a colector 1124 cc (\*)
- 7954 mgto de carburador a colector 1360 cc (\*)
- 3578 tapa bomba de agua (plástico)
- 9- 7946 mgto de botella a radiador (radiador metálico)
- 10- 3501 botella de expansión
- 3519 tapón botella expansión 0,7 bar
- 3524 tapón botella expansión 1,0 bar
- 11- 3081 boquilla metálica en caja termostato Ø 15,5 mm
- 3082 boquilla metálica en caja termostato Ø 10 mm

(\*) excepto modelos de inyección desde '93 y "Rallye"

- 8002 mgto desvaporizador
- 8324 mgto desvaporizador

309 motores 1294 (G1), 1442 (Y2) y 1592 cc (J2):

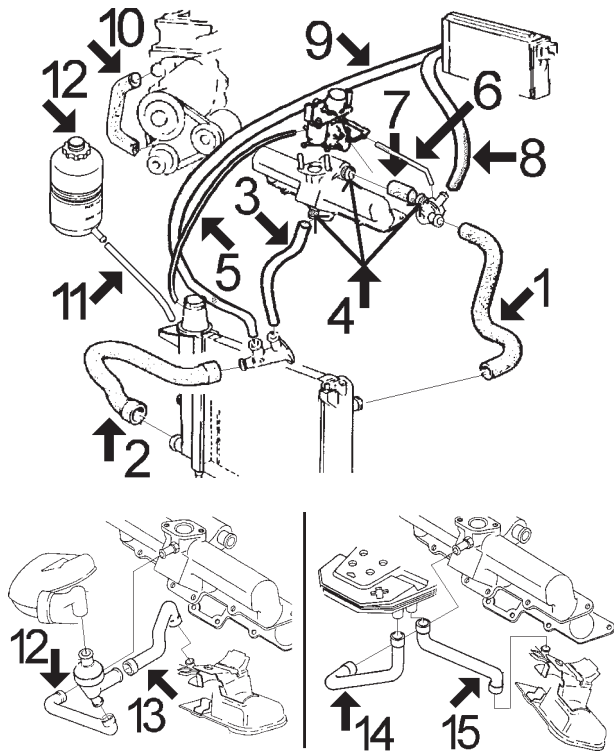

- 1- 7627 mgto superior de radiador
- 2- 7626 mgto inferior de radiador 1294 cc  
7724 mgto inferior de radiador 1442 y 1592 cc
- 3- 5899 mgto de racor entrada a colector 1294 cc  
7655 mgto de racor entrada a colector 1442 y 1592 cc
- 4- n/d racor en colector y caja de termostato
- 5- 7875 mgto de radiador a carburador
- 6- 7952 mgto de carburador a caja de termostato
- 7- 7581 mgto de colector a caja de termostato 1294 cc  
7928 mgto de colector a caja termostato 1442-1592 cc
- 8- n/d mgto de calefactor a termostato 1294 cc  
7660 mgto de calefactor a termostato 1442 y 1592 cc
- 9- 7889 mgto de calefactor a racor entrada
- 10- 7708 mgto de bomba de agua a tapa
- 11- 117 mgto de botella a radiador: Cortar de rollo ref. MC-117 Ø 10x17 mm, long. aprox. 130 cms.
- 12- 3501 botella de expansión  
3519 tapón botella expansión 0,7 bar  
3524 tapón botella expansión 1,0 bar

MGTOSESVAPORIZADORES:

- 12- 8002 tubo de regulador a colector 1294 cc
- 13- 8001 tubo de regulador a tapa de balancines 1294 cc
- 14- 8002 tubo de filtro de aire a colector 1442 y 1592 cc
- 15- 8003 tubo de filtro de aire a tapa de balancines 1442 y 1592 cc

205 motores 1580 cc (XU51C-Automático) y 1905 cc (XU9JA-inyección)  
309 motores 1580 cc (XU52C) y 1905 cc (XU92C-carburador y XU9JA-inyección)

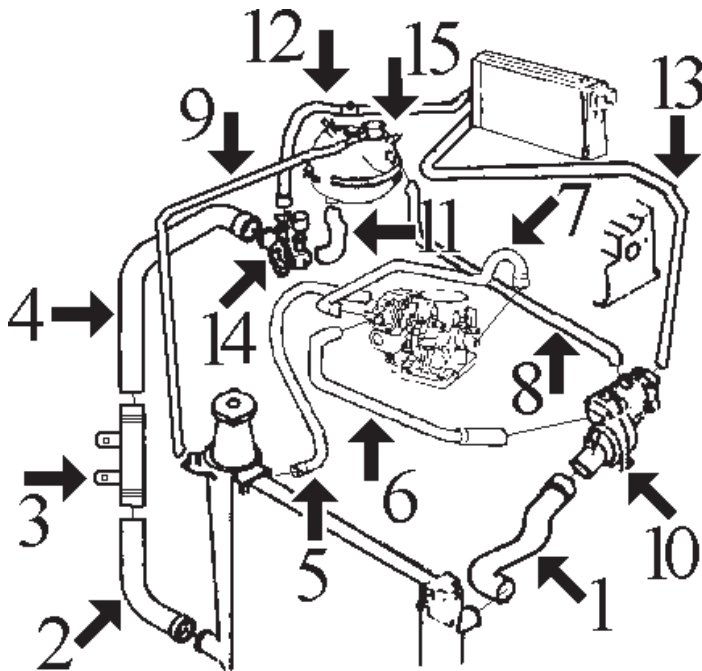

- 1- 7856 mgto superior radiador 205 1.9 GTI sin aire ac.  
7757 mgto superior de radiador 309 1.6 y 1.9 carburador (excepto 1.6 automático)  
8545 mgto superior radiador 1.6 desde '91 (inyección)  
n/d mgto superior radiador 205-309 automáticos  
n/d mgto superior de radiador 205 1.9 GTI con aire ac.  
n/d mgto superior de radiador 309 1.9 GTI con aire ac.
- 2- 7563 mgto inferior de radiador 205 1580 automático y 1.9 GTI sin aire acondicionado  
8184 mgto inferior de radiador 205 y 309 1580 cc automáticos y 1.9 GTI con aire acondicionado  
7758 mgto inferior de radiador 309
- 3- 3056 tubo metálico enlace mgto inferiores
- 4- 7544 mgto de tubo metálico a bomba hasta '91 (carbur.)  
8546 mgto de tubo metálico a bomba desde '91 (inyecc.)
- 5- 116 mgto de carburador a radiador 205 1.6 automático y 309 1.6 y 1.9 carburador: Cortar de rollo MC-116 Ø 8x13 mm, long. aprox. 90 cms
- 6- 116 mgto de carburador a caja termostato 205 1.6 automático y 309 1.6-1.9 carburador: Cortar de rollo MC-116 Ø 8x13 mm, long. aprox. 25 cms.
- 7- n/d mgto a stárter 205 1.6 automático y 309 1.6 y 1.9 carburador
- 8- 8015 mgto de botella a caja termostato 309 1.9 carbur.
- 9- 117 mgto de botella a radiador: Cortar de rollo MC-117 Ø 10x17 mm, long. aprox. 130 cms.
- 10- 3551 tapa de termostato 1.6 desde '91 (inyección)  
2351 junta de termostato desde mod. '91
- 11- 8150 mgto de botella a racor entrada agua
- 12- n/d mgto de calefactor a bomba
- 13- n/d mgto de calefactor a termostato hasta '91 (carbur.)  
8544 mgto de calefactor a termostato desde '91 (inyecc.)
- 14- 3523 racor entrada conexión mgto
- 15- 3558 botella expansión  
3608 tapón botella expansión 1.4 bar

n/d = no disponible

mgto desvaporizadores: ver Citroën BX motor XU

205 motor DIESEL 1769 cc (XUD7)  
 309 motores DIESEL 1905 cc (XUD9) y TURBODIESEL 1769 cc (XUD7T)

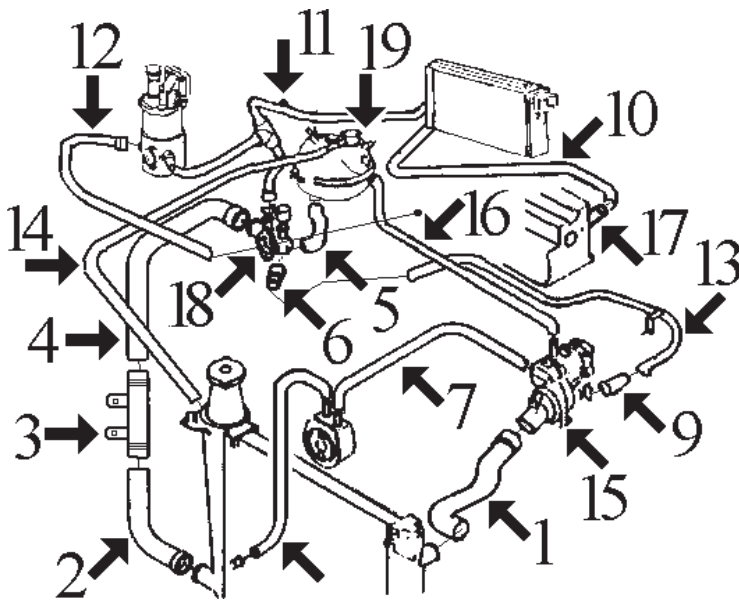

- 1- 7562 mgto superior radiador 205 D hasta '92  
 8547 mgto superior radiador 205 D desde '92  
 7759 mgto superior radiador 309 D-TD
- 2- 7563 mgto inferior radiador 205 D sin aire ac. hasta '92  
 8184 mgto inferior radiador 205 D con aire ac. hasta '92  
 8546 mgto inferior radiador 205 D desde '92  
 7758 mgto inferior radiador 309 D-TD
- 3- 3056 tubo metálico unión mgto inferior
- 4- 7544 mgto de tubo a bomba de agua
- 5- 8063 mgto de botella a bomba hasta '90  
 8150 mgto de botella a bomba desde '90
- 6- 7949 mgto de tubo a bomba 205 D hasta '90 y 309 D  
 7948 mgto de tubo a bomba 205 D desde '90 y 309 TD
- 7- 8062 mgto de intercambiador a termostato 309 D y TD
- 8- 8151 mgto de radiador a intercambiador 309 D y TD
- 9- 7947 mgto de tubo a termostato 205 D h/ '90 y 309 D  
 7949 mgto de tubo a termostato 205 D d/ '90 y 309 TD
- 10- 7886 mgto de calefactor a culata hasta '92  
 8543 mgto de calefactor a culata desde '92
- 11- 7887 mgto de calefactor a bomba y filtro gasoil 205 D y 309 D hasta '90 (3 vias)  
 8065 mgto de calefactor a bomba 205 D y 309 D desde '90 y 309 TD
- 12- 8153 mgto de filtro gasoil a culata 205 D  
 8736 mgto de filtro gasoil a culata 309 D hasta '90
- 13- 3019 tubo de agua metálico hasta '91  
 3134 tubo de agua metálico desde '91 hasta '93  
 3057 tubo de agua metálico desde '93
- 14- 117 mgto de botella a radiador: Cortar de rollo MC-117 Ø 10x17 mm long. aprox. 130 cms.
- 15- 3616 tapa de termostato 1.7 Diesel sin intercambiador en filtro de aceite  
 3539 tapa de termostato 1.7 Diesel con intercambiador en filtro de aceite y 1.9 D-TD todos  
 2361 junta de termostato desde '92  
 3171 boquilla metálica en tapa de termostato
- 16- 8015 mgto de botella a tapa de termostato
- 17- 3059 boquilla metálica clavada en culata
- 18- 3503 brida entrada agua conexión mgts
- 19- 3558 botella expansión  
 3608 tapón botella expansión 1.4 bar

Nota 1: 205 Diesel no lleva intercambiador en el filtro de aceite, por lo que no monta los mgts n° 7 ni n° 8  
 Nota 2: a partir del modelo '90 el filtro de gasoil no tiene circulación de agua, por lo que a partir de esta fecha desaparece el mgto n° 12 y el n° 11 pierde la 3ª vía.

**mgts. desvaporizadores Diesel XU:**

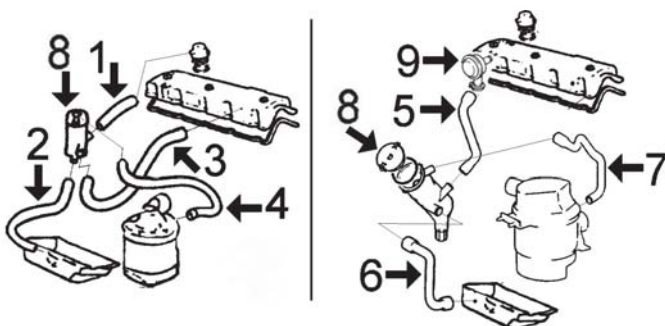

**decantador hasta PR-3606 (10/'86)**

- 1- 8160 tubo a tapón de llenado
- 2- 8160 tubo a cárter de aceite
- 3- 7990 tubo a tapa de balancines
- 4- 8161 tubo a filtro de aire
- 8- 3631 decantador con tapón

**decantador desde PR-3607 (10/'86)**

- 5- 8165 tubo a tapa de balancines
- 6- 8166 tubo a bloque motor
- 7- 8164 tubo a filtro de aire hasta '92  
 7990 tubo a filtro de aire desde '92
- 8- 3631 decantador con tapón
- 9- 3637 válvula desvaporizadora



PEUGEOT 205 - 309



**5899**  
mgto de racor a colector  
r.o. 1307.G2



**7544**  
mgto de tubo a bomba Diesel y XU  
r.o. 1307.K0-1307.W9



**7559**  
mgto superior radiador 205 todos gasolina  
salvo TU, r.o. 1317.23-1317.24



**7561**  
mgto inferior radiador 205 todos gaolina  
salvo TU, r.o. 1317.25



**7562**  
mgto superior radiador 205 Diesel  
r.o. 1343.70



**7563**  
mgto inferior radiador 205 D y XU sin  
aire acond., r.o. 1307.75



**7581**  
mgto de colector a termostato  
(Ø24-largo 105), r.o. 1317.29



**7582**  
mgto de racor 3 vias a colector 205 E1-F1-  
G1 (Ø24-largo 55), r.o. 1317.32



**7626**  
mgto inferior radiador 309 1294 cc  
r.o. 1317.27



**7627**  
mgto superior radiador 309 todos salvo D y  
XU, r.o. 1317.26



**7655**  
mgto de racor entrada a colector  
r.o. 1317.28



**7660**  
mgto de calefactor a culata 205 (todos sal-  
vo D-TU-XU) y 309 Y2-J2, r.o. 1307.A0



**7708**  
mgto de bomba de agua a tapa todos salvo  
TU-D-XU, r.o. 1307.97



**7724**  
mgto inferior radiador 309 1442-1592 cc  
r.o. 1307.G3



**7745**  
mgto superior radiador 205 TU con radi-  
dor de plástico, r.o. 1343.E8



**7746**  
mgto inferior radiador 205 TU  
r.o. 1351.80



**7751**  
mgto de calefactor a racor 205 todos salvo  
D-TU-XU, r.o. 1307.A1



**7757**  
mgto superior radiador 309-1.6XU y 1905  
r.o. 1343.79



**7758**  
mgto inferior radiador 309 Diesel y XU  
r.o. 1351.21



**7759**  
mgto superior radiador 309 Diesel  
r.o. 1343.82



**7856**  
mgto superior radiador 205 GTI sin aire  
acondicionado, r.o. 1343.C3

PEUGEOT 205 - 309



**7875**  
mgto de radiador a carburador 309  
r.o. 1414.32-1414.33



**7886**  
mgto de calefactor 205 D - 309 D  
r.o. 1307.F3



**7887**  
mgto de calefactor a bomba 205 D-309 D  
hasta '90, r.o. 1307.B1



**7888**  
mgto superior radiador 205 TU con radiador  
metálico, r.o. 1343.96



**7889**  
mgto de calefactor a racor 309 G1-Y2-J2  
r.o.1307.C7



**7893**  
mgto calefactor 309 1580-1905 cc salvo  
GTI, r.o. 1307.C9



**7928**  
mgto de colector a termost. 309 1442-1592  
r.o.1307.98 (Ø25-22, largo 105 mm)



**7946**  
mgto de botella a radiador 205 TU (radi-  
ador metálico), r.o. 1303.72



**7947**  
mgto de tubo a termostato 205D-309D h/'90  
r.o. 1307.42



**7948**  
mgto de tubo a bomba 205D-309D d/'90  
y 309 TD, r.o. 1307.J3 (Ø24-20)



**7949**  
mgto de tubo a bomba o termost. 205D-  
309D, r.o. 1307.J4 (Ø27-22)



**7952**  
mgto de carburador a colector 205  
r.o. 1413.43-1413.96-1413.95



**7953**  
mgto de colector a carburador 205 1.1 TU  
r.o. 1413.93



**7954**  
mgto de colector a carbur. 205 1.4-TU  
r.o. 1413.94



**7990**  
mgto desvaporizador Diesel hasta '87  
r.o. 1192.31



**8001**  
mgto desvaporizador 1294 cc  
r.o. 1191.12



**8002**  
mgto desvaporiz. 1294 cc y 1.1-1.4 TU  
r.o. 1191.13-1191.21



**8003**  
mgto desvaporizador 1442-1592 cc  
r.o. 1191.20



**8015**  
mgto de botella a termostato Diesel  
r.o.1351.11



**8062**  
mgto de intercambiador a termost. 309D  
y TD, r.o. 1307.J5

PEUGEOT 205 - 309



**8063**  
mgto de botella a bomba Diesel y XU  
hasta '90, r.o. 1350.95



**8065**  
mgto de calefactor a bomba Diesel desde '90  
309 1.9 y GTI, r.o. 1307.P5-1307.B5



**8150**  
mgto de botella a bomba Diesel y XU des-  
de '90, r.o. 1351.95



**8151**  
mgto de radiador a intercambiador 309  
D desde '90 y TD, r.o. 1307.K1



**8153**  
mgto de filtro gasoil a culata Diesel hasta '90  
r.o. 1910.31



**8160**  
mgto desvaporizador Diesel hasta '87  
r.o. 1192.30



**8161**  
mgto desvaporizador Diesel hasta '87  
r.o. 1192.32



**8164**  
mgto desvaporizador Diesel desde '87  
r.o. 1192.50



**8165**  
mgto desvaporizador Diesel desde '87  
r.o. 1192.49



**8166**  
mgto desvaporizador Diesel desde '87  
r.o. 1192.48



**8177**  
mgto de calefactor a bomba 205 TU  
r.o. 6464.V4



**8178**  
mgto de calefactor a termostato 205 TU  
r.o. 6464.A5



**8184**  
mgto inf radiador 205/309 motor XU y Die-  
sel con aire acondicionado, r.o. 1307.X0



**8187**  
mgto desvaporizador 1.6XU-1.9XU  
r.o. 1180.25



**8304**  
mgto desvaporizador 1.6XU-1.9XU  
r.o. 1180.34



**8305**  
mgto desvaporizador 1.6XU-1.9XU  
r.o. 1192.66

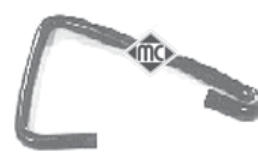

**8309**  
mgto desvaporizador 1.6XU-1.9XU  
r.o. 1180.34



**8320**  
mgto desvaporizador 1.6XU-1.9XU  
r.o. 1192.56



**8324**  
mgto desvaporizador 205-309 1.1-1.4 TU  
r.o. 1192.C6



**8543**  
mgto de calefactor a culata 205 D desde '92  
r.o.



**8544**  
mgto de calefactor a termostato 205 desde  
'91 (inyección), r.o.

PEUGEOT 205 - 309

 <p><b>8545</b> mgto superior radiador 205 1.6 desde '91 (inyección), r.o.</p>	 <p><b>8546</b> mgto inferior radiador 205 desde '92 r.o.</p>	 <p><b>8547</b> mgto superior radiador 205 desde '92 r.o.</p>
 <p><b>8686</b> mgto superior radiador 309 "TU" r.o.</p>	 <p><b>8736</b> mgto de filtro gasoil a culata 309 Diesel r.o. 1910.33</p>	  <p><b>7659</b> bocas Ø 40-48, largo 128 mm tubo llenado combustible 205 r.o. 1504.91 - 1505.84</p>
 <p><b>2351</b> Ø 41 x 47 junta de termostato 205 TU y 1.9 d/ '91 r.o. 1339.53</p>	 <p><b>2361</b> Ø 51 x 58 junta de termostato 205 D-309 D y TD desde '92, r.o. 1339.92</p>	 <p><b>3011</b> boquilla alojamiento termostato 205 TU r.o. 1336.44</p>
 <p><b>3019</b> tubo metálico 205 Diesel hasta '89 r.o. 1213.29</p>	 <p><b>3056</b> tubo metálico Diesel-GTI y 1.9 r.o. 1307.78</p>	 <p><b>3134</b> tubo metálico Diesel desde '89 hasta '91 r.o. 1213.31</p>
 <p><b>3057</b> tubo metálico Diesel desde '91 r.o. 1307.W2</p>	 <p><b>3059</b> boquilla metálica en culata Diesel r.o. 0245.42-0245.44</p>	 <p><b>3081</b> Ø 15,5 mm boquilla en caja termostato 1.1-1.4 TU r.o. 96064657</p>
 <p><b>3082</b> Ø 10 mm boquilla en caja termostato 1.1-1.4 TU r.o. 96064659</p>	 <p><b>3171</b> boquilla en caja termostato Diesel-XU r.o. 1336.N7</p>	



PEUGEOT 205 - 309



**3501**

botella expansión 1.3-1.4 y 1.6 hasta '91 y 1.1-1.4 (TU) desde '91, r.o. 1307.93



**3519** 0,7 bar      **3524** 1,0 bar  
tapón botella expansión  
r.o. 1303.40 (blanco) r.o. 1306.43 (negro)



**3503**      **con junta tórica**  
racor entrada agua conexión mgts Diesel  
r.o. 1336.G4+1340.28

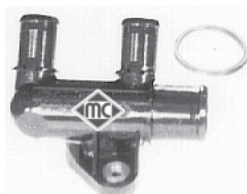

**3523**      **con junta tórica**  
racor entrada agua conexión mgts 1.6 y 1.9 XU, r.o. 1336.H7+1339.79



**3539**  
tapa de termostato 1.9 Diesel y TD desde '92  
r.o. 1336.C9



**3551**  
tapa termostato 1.6 desde '91  
r.o. 1336.88



**3578**  
tapa bomba de agua motores "TU"  
r.o. 1201.66



**3558**  
botella de expansión Diesel, 1.6 y 1.9  
r.o. 1303.53



**3608**  
tapón botella expansión 1.2 bar  
(metálico) r.o. 1306.85



**3616**  
tapa de termostato 1.7 D sin intercambiador  
en filtro de aceite, r.o. 1336.E8



**3631**  
decantador completo con tapón Diesel  
r.o. 1180.95

**¡Nuevo!**



**3637**  
válvula reguladora desvaporizador Diesel  
r.o. 0361.58

**¡Nuevo!**



**4490**  
soporte decantador motores gasolina XU  
r.o. 1439.10

SUSPENSION DELANTERA Y SOPORTES DE MOTOR:

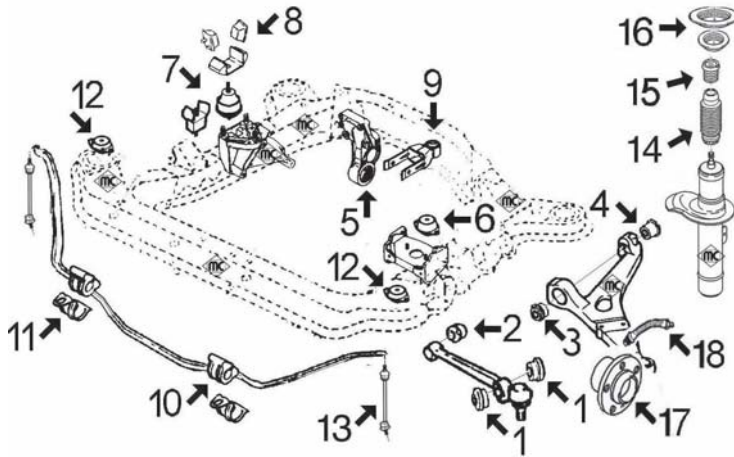

- 1- 685 silentbloc central brazo delantero 205 (\*)
- 686 silentbloc central brazo delantero 309 (\*)
- 2- 454 silentbloc punta brazo delantero 205 (\*)
- 2402 silentbloc punta brazo delantero 309 (\*)
- 3- 2402 silentbloc anterior trapecio delantero 309 (\*)
- 4- 893 silentbloc posterior trapecio delantero 309 (\*)
- 5- 694 silentbloc para soporte motor trasero todos salvo 205 motor TU
- 751 silentbloc soporte de motor trasero 205 TU
- 6- 531 soporte izquierdo de motor
- 7- 535 soporte derecho de motor 205-309 hasta '89 salvo Diesel y XU
- 697 soporte de motor derecho Diesel y XU desde '89
- 8- 724 limitador soporte derecho Diesel y XU hasta '89
- 905 limitador soporte derecho todos desde '89
- 9- 4743 tirante posterior motor completo 1.1-1.2-1.3-1.4
- 4744 tirante posterior motor completo 1.6-1.9-1.7D-1.9D
- 877 silentbloc de tirante trasero de motor
- 10- 687 goma barra estabilizadora Ø 20 mm "blanca"
- 688 goma barra estabilizadora Ø 22 mm "verde"
- 2488 goma barra estabilizadora Ø 23 mm "azul"
- 11- 901 abrazadera barra estabilizadora
- 12- n/d soporte travesaño subchasis delantero
- 13- 4035 bieleta puntal 1.3-Rallye y 1.9 GTI
- 14- 2933 capuchón amortiguador delantero
- 15- 2972 tope goma suspensión delantera altura 57 mm
- 2975 tope poliuret. suspensión delantera altura 79 mm
- 2971 tope poliuret. suspensión delantera altura 97 mm
- 16- 4406 soporte amortiguador completo con rodamiento
- 17- 90013 buje rueda delantera 1.1-1.4
- 90012 buje rueda delantera 1.6-1.9-Diesel y TurboD
- 18- 96009 latiguillo freno delantero (352 mm)
- 96160 latiguillo freno delantero (435 mm)

(\*) modelos con brazo: 1.1 - 1.4 - 1.6 y 1.7 Diesel  
 modelos con trapecio: 1.9 gasolina y 1.7 TurboDiesel

SUSPENSION TRASERA:

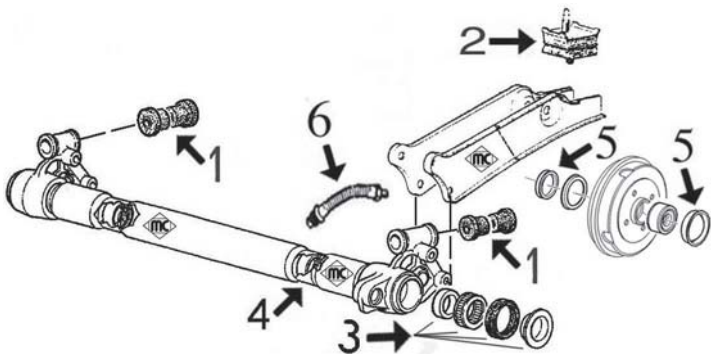

- 1- 4246 silentbloc soporte puente trasero (4x vehículo)
- 2- 2969 soporte brazo trasero
- 3- 4413 kit reparación brazo trasero con rodamientos
- 4- 4550 eje brazo trasero (derecho e izquierdo)
- 5- 4828 juego retén eje trasero y tapón de tambor
- 6- 96053 latiguillo freno trasero (275 mm)

PEUGEOT 205 - 309



**685**  
silentbloc central brazo delantero 205  
r.o. 3523.49 (12x36x25 ala 47)



**686**  
silentbloc central brazo delantero 309  
r.o. 3523.35 (12x36x25 ala 51)



**454**  
silentbloc punta brazo delantero 205  
r.o. 3523.20 (10x28x28x34)



**2402**  
silentbloc punta brazo delantero y anterior trapecio delantero 309, (10x28x25 ala 38)



**893**  
silentbloc posterior trapecio delantero 309  
r.o. 3523.23 (12x31x30 ala 42)



**694** Ø 70 mm  
silentbloc soporte motor trasero  
r.o. (no hay despiece)



**751** Ø 65 mm  
silentbloc soporte de motor trasero 205 TU  
r.o. (no hay despiece)



**531**  
soporte de motor izquierdo  
r.o. 1843.95



**535**  
soporte de motor derecho hasta '89  
r.o. 1843.88



**697** **HIDRAULICO (650 g.)**  
soporte de motor derecho desde '89  
r.o. 1844.42-1844.38-1843.73



**697/1** **no hidráulico (460 g.)**  
soporte de motor derecho desde '89  
r.o. --



**905**  
limitador soporte motor derecho desde '89  
r.o. 1844.17



**724**  
limitador soporte motor derecho hasta '89  
r.o. 1844.16

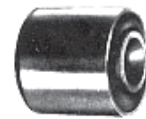

**877**  
silentbloc tirante trasero de motor  
r.o. 1809.04 (12x30x28x34)



**687** **transparente**  
goma para barra estabilizadora de Ø 20mm  
r.o. 5094.36



**688** **verde**  
goma para barra estabilizadora de Ø 22mm  
r.o. 5094.37



**2488** **azul**  
goma para barra estabilizadora de Ø 23mm  
r.o. 5094.40









**901**  
abrazadera barra estabilizadora  
r.o. 5097.27



**2971** **altura 97 mm**  
tope poliuretano suspensión delantera  
r.o.

PEUGEOT 205 - 309







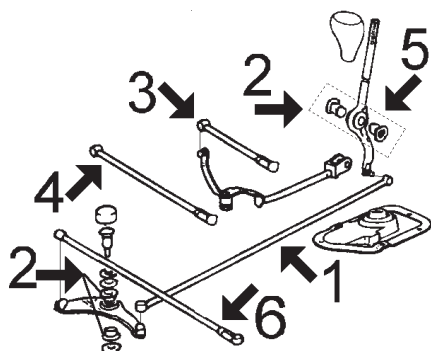



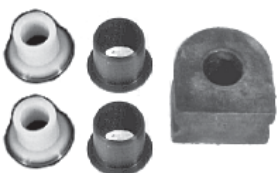

<p><b>iNuevo!</b></p>  <p><b>4743</b> tirnte posterior motor completo 1.1-1.2-1.3-1.4 r.o.</p>	<p><b>iNuevo!</b></p>  <p><b>4744</b> tirante posterior motor completo 1.6-1.9-1.7D-1.9D,r.o.</p>	<p><b>iNuevo!</b></p>  <p><b>4550</b> eje brazo trasero (derecho e izquierdo) r.o.5176.17</p>
 <p><b>2972</b> altura 57 mm tope goma suspensión delantera r.o.5033.23</p>	 <p><b>2975</b> altura 79 mm tope poliuretano suspensión delantera r.o.</p>	 <p><b>4406</b> soporte amortiguador delantero con rodamiento,r.o.5031.25-5031.92</p>
 <p><b>2933</b> capuchón amortiguador delantero r.o.5254.13</p>	 <p><b>4035</b> bieleta puntal barra estabilizadora 1.9 GTi y 1.3 Rallye,r.o.5087.32</p>	 <p><b>2969</b> soporte brazo trasero suspensión r.o.5151.10</p>
 <p><b>4246</b> silentbloc puente trasero (4 por vehículo) r.o.5131.43-5131.44</p>	 <p><b>4036</b> bomba manual cebado gasoil con válvula antirretorno y boquilla adicional a 90°</p>	<p><b>iNuevo!</b></p>  <p><b>4413</b> kit reparación brazo trasero completo con rodamientos,r.o.</p>
<p><b>iNuevo!</b></p>  <p><b>4828</b> juego retén eje trasero y tapón de tambor r.o.3724.24+3740.19</p>	 <p><b>90013</b> buje rueda delantera 1.1-1.4 TU salvo Rallye(TU24),r.o.3307.49</p>	 <p><b>90012</b> buje rueda delantera 1.6-1.9-Diesel-TurboD r.o.3307.72</p>
 <p><b>96009</b> latiguillo freno delantero (352 mm) r.o.4806.37</p>	 <p><b>96160</b> latiguillo freno delantero (435 mm) r.o.4806.31</p>	 <p><b>96053</b> latiguillo freno trasero (275 mm) r.o.4816.29</p>



ARTICULACIONES PALANCA DE CAMBIO:

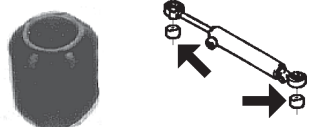

- 1- 2322 barra paso de velocidades
- 2- 2409 juego casquillos palanca de cambio todos salvo 205 motor TU
- 3- 2347 bieleta de selección 205 hasta '87
- 4- 2347 bieleta de selección
- 5- 2400 casquillo palanca de cambio 205 TU
- 6- 2348 bieleta de reenvio

<p>long. 740 mm rótulas de Ø 13 mm</p>  <p><b>2322</b> barra paso de velocidades r.o. 2414.96</p>	<p>long. máx: 135 mm long. mín: 90 mm rótulas de Ø 10</p>  <p><b>2347</b> bieleta de selección velocidades r.o. 2454.94-2454.74</p>	<p>long. máx: 300 mm long. mín: 265 mm rótulas de Ø 13 mm</p>  <p><b>2348</b> bieleta de selección velocidades r.o. 2444.82</p>
 <p><b>2409</b> juego casquillos palanca de cambio y reenvio 205-309, r.o. 2175.05-2450.27</p>	 <p><b>2400</b> casquillo palanca de cambio 205 motor TU r.o.</p>	
 <p><b>4395</b> cruceta dirección desde 9/'89 (360 mm) r.o. 4103.A9(4103.A8)</p>	 <p><b>1268 kit</b>                      <b>268 fuelle</b> fuelle cremallera dirección r.o. 4066.15</p>	 <p><b>287</b> juego casquillos cremallera r.o.</p>
 <p><b>536</b> fuelle derecho cremallera asistida r.o. 4066.22</p>	 <p><b>844</b> capuchón derecho cremallera asistida r.o. 4066.16</p>	 <p><b>2306</b> silentbloc pistón cremallera asist. (Ø 20) r.o. 4059.06</p>
 <p><b>4043</b> juego casquillos horquilla embrague Diesel r.o. 2175.20+2175.21</p>	 <p><b>4052</b> horquilla embrague Diesel completa con casquillos, r.o. 2115.25</p>	 <p><b>4057</b> juego casquillos horquilla embrague gasolina TU, r.o. 2175.11+2175.12</p>

PEUGEOT 205 - 309

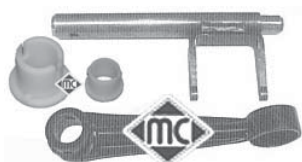

**4300**  
horquilla embrague completa motor "TU"  
r.o. 2117.52

**¡Nuevo!**



**4424**  
casquillo guía embrague motor 1.1-1.4TU  
r.o. 2105.14

**¡Nuevo!**



**4605**  
casquillo guía embrague motor XU (1.6-1.7D-1.9D), r.o. 2105.35



**2335**  
varilla nivel aceite motor 1.1-1.4TU  
r.o. 1174.10-1174.49

**¡Nuevo!**



**4612**  
varilla nivel aceite motor 1.7D-1.9D  
r.o. 1174.15

**¡Nuevo!**



**4672**  
varilla nivel aceite motor 1.6XU-1.9XU (gasolina), r.o. 1172.79

**¡Nuevo!**



**3697**  
juego tapas correa distribución 1.1TU-1.4TU  
r.o. 0320.S2+0320.L3

**¡Nuevo!**

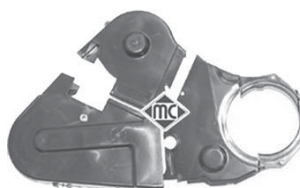

**3698**  
juego tapas correa distribución XUD desde 1/94, r.o. 0320.H2+0320.H3+0320.F9

**¡Nuevo!**



**4564** Ø 30/47 y 40/58 mm  
juego retenes diferencial-transmisión  
r.o. 3121.44+3124.46



**1710E**  
kit rep transm l/rda **para montar con cono**  
en neopreno especial de elasticidad 800%



**1710**  
kit rep transm. l/rda. desde '87 (una garg.)  
r.o. 3293.77



**1273**  
kit rep. transm. l/rda hasta '87 (doble garg.)  
r.o. 3293.41-3293.74



**1273E**  
kit rep transm l/rda **para montar con cono**  
en neopreno especial de elasticidad 800%

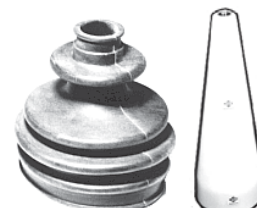

**1708E**  
kit rep. transm. l/rda 1.9, GTI y TurboD.  
**para montar con cono**



**1708**  
kit rep. transm. l/rda 1.9, GTI y TurboD.  
r.o. 3293.91



**1362**  
kit rep. transmisión l/cambio  
r.o. 3293.59



**1626**  
kit rep. transmisión l/cambio 1592 cc  
r.o. 3287.65



**1521**  
kit rep. transmisión l/rda desde '95  
r.o.



**1533**  
kit rep. transm. l/cambio 205 TU  
r.o. 3287.69



**2848**  
polea cigueñal Diesel (Ø 142, 5 canales)  
compatible con 4 canales, r.o. 0515.K9

PEUGEOT 205 - 309

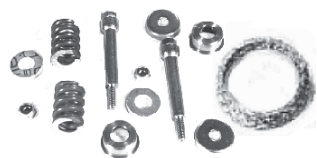

**2391** Ø 66 mm  
kit montaje tubo de escape todos salvo Diesel y GTI, r.o. 1798.54



**2395** Ø 66 mm  
junta cónica tubo de escape todos salvo Diesel y GTI



**2392** Ø 46.2 mm  
kit montaje tubo de escape Diesel y motor TU, r.o. 1798.45



**2393** Ø 46.2 mm  
junta cónica tubo de escape Diesel y motor TU, r.o. 1712.63



**303**  
soporte tubo de escape "ancho" r.o. 1755.40

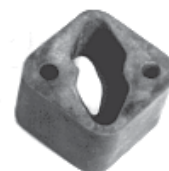

**2417**  
soporte tubo de escape "estrecho" r.o.



**671** Ø 20x150  
tapones cárter de aceite (latón) r.o. 0163.21



**667** Ø 16x150  
tapón cárter de aceite r.o. 2221.11



**942**  
capuchón protector Delco r.o. 5966.16

CANALIZACIONES DE AGUA

206 1.1, 1.4 y 1.6 gasolina motores TU (TU1JP, TU3JP y TU5JP)

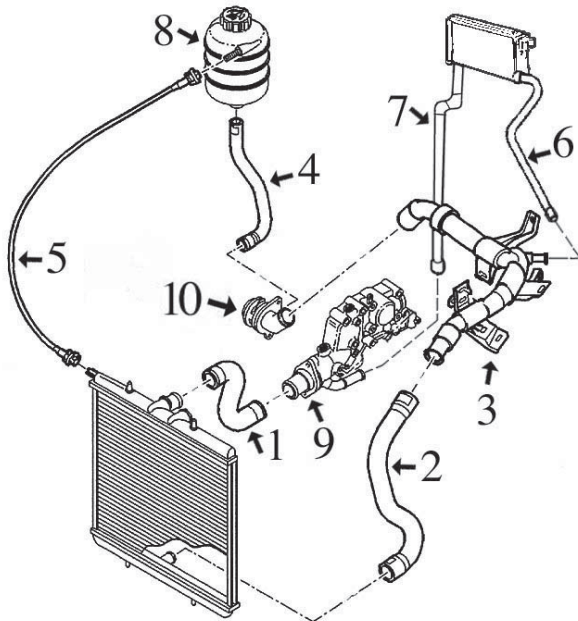

- 1- 8618 mgto superior radiador
- 2- 8624 mgto inferior radiador
- 3- n/d tubo conexión (plástico)
- 4- 8673 mgto de bomba a botella
- 5- 8675 mgto de botella a radiador
- 6- 8680 mgto de calefactor a tubo plástico
- 7- 8679 mgto de calefactor a caja termostato
- 8- 3656 botella de expansión  
3560 tapón botella radiador 1.4 bar
- 9- 3620 tapa con termostato
- 10- 3641 tapa bomba de agua 1.1-1.4  
3640 tapa bomba de agua 1.6

206 2.0-16v. motor gasolina EW10J4

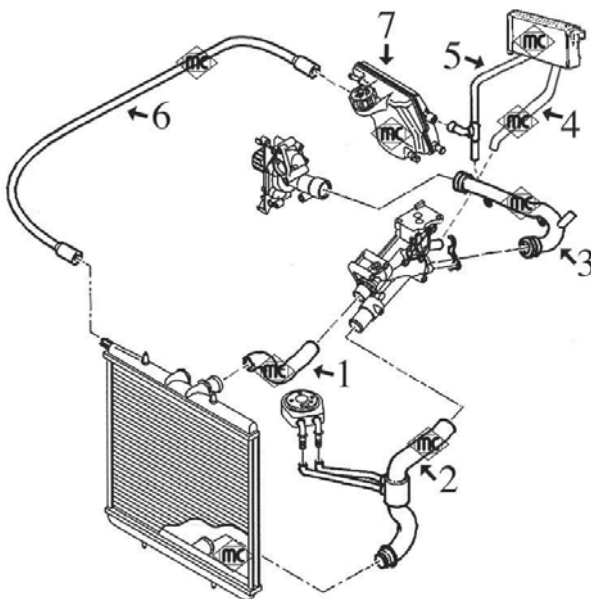

- 1- 8677 mgto superior radiador
- 2- 8678 mgto inferior radiador
- 3- n/d tubo de caja termostato a bomba
- 4- 8684 mgto de calefactor a caja termostato
- 5- 8685 mgto de calefactor a tubo
- 6- 8675 mgto de botella a radiador
- 7- 3657 botella de expansión  
3560 tapón botella radiador



206 1.9 Diesel motor DW8

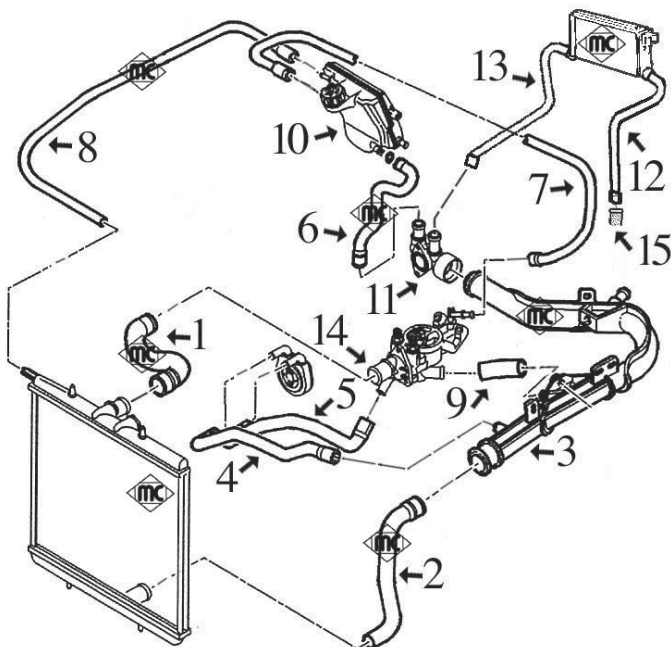

- 1- 8620 mgto superior radiador
- 2- 8625 mgto inferior radiador
- 3- n/d tubo plástico de mgto superior a racor
- 4- 8628 mgto de intercambiador a tubo plástico
- 5- 8558 mgto de intercambiador a caja de termostato
- 6- 8674 mgto de botella a racor conexión
- 7- 117 mgto de caja termostato a botella, cortar de rollo MC-117 (Ø 10x16 mm)
- 8- 8675 mgto de botella a radiador
- 9- 8627 mgto de caja termostato a tubo plástico
- 10- 3657 botella de expansión  
3560 tapón botella radiador 1.4 bar
- 11- 3555 racor conexión manguitos
- 12- 8756 mgto de calefactor a culata
- 13- 8757 mgto de calefactor a racor conexión
- 14- 3539 tapa de termostato  
3171 boquilla metálica en caja termostato  
2361 junta de termostato
- 15- 3059 racor metálico en culata

MGTOS DESVAPORIZADORES:

- 8474 mgto de cárter a culata
- 8475 mgto de tapa balancines a colector

206 2.0 Diesel HDi motor DW10TD

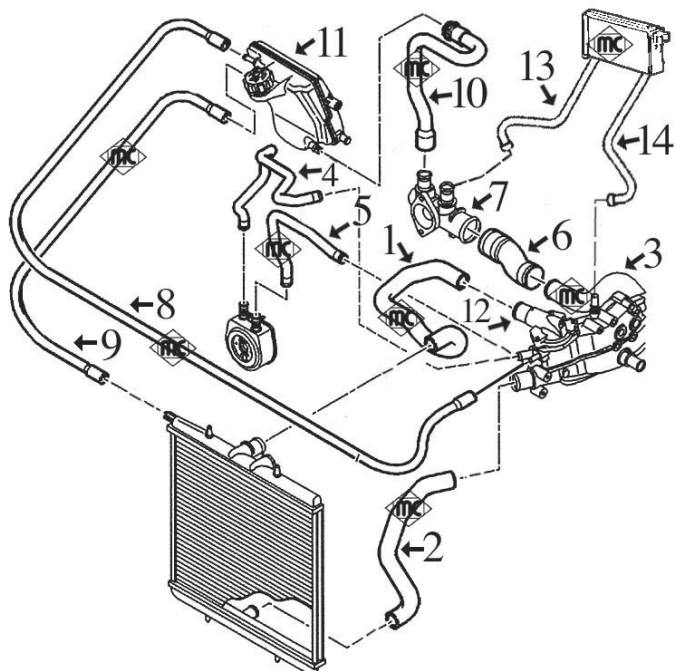

- 1- 8622 mgto superior radiador
- 2- 8633 mgto inferior radiador
- 3- 3139 tubo metálico de caja termostato a mgto
- 4- 8585 mgto de intercambiador a caja termostato
- 5- 8586 mgto de intercambiador a caja de termostato
- 6- 8587 mgto de racor a tubo metálico
- 7- 3554 racor conexión manguitos
- 8- 8683 mgto de botella a caja termostato
- 9- 8675 mgto de botella a radiador
- 10- 8681 mgto de racor conexión a botella
- 11- 3657 botella de expansión  
3560 tapón botella radiador 1.4 bar
- 12- 3135 tapa de termostato de aluminio  
3556 tapa de termostato de plástico
- 13- 8755 mgto de calefactor a racor conexión
- 14- 8682 mgto de calefactor caja termostato

MGTOS DESVAPORIZADORES:

- 8539 mgto de tapa balancines a colector
- 8540 mgto de cárter a culata

PEUGEOT - 206



**8474**  
mgto desvaporizador 1.9 D  
r.o.



**8475**  
mgto desvaporizador 1.9 D  
r.o.



**8539**  
mgto desvaporizador 2.0 HDi  
r.o.



**8540**  
mgto desvaporizador 2.0 HDi  
r.o.



**8558**  
mgto de intercambiador a radiador 1.9D  
r.o.



**8585**  
mgto de intercambiador 2.0 HDi  
r.o.



**8586**  
mgto de intercambiador 2.0 HDi  
r.o.



**8587**  
mgto de tubo metálico a racor 2.0 HDi  
r.o.



**8618**  
mgto superior radiador 1.1-1.4-1.6  
r.o.



**8620**  
mgto superior radiador 1.9 D  
r.o.



**8622**  
mgto superior radiador 2.0 HDi  
r.o.



**8624**  
mgto inferior radiador 1.1-1.4-1.6  
r.o.



**8625**  
mgto inferior radiador 1.9 D  
r.o.



**8627**  
mgto de caja termostato a tubo 1.9 D  
r.o.



**8628**  
mgto de intercambiador a tubo 1.9 D  
r.o.



**8633**  
mgto inferior radiador 2.0 HDi  
r.o.



**8673**  
mgto de bomba a botella 1.1-1.4-1.6  
r.o.



**8674**  
mgto de botella a racor conexión 1.9 D  
r.o.

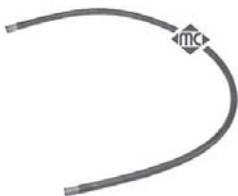

**8675**  
mgto de botella a radiador 1.9 D  
r.o.



**8677**  
mgto superior radiador 2.0-16v.  
r.o.



**8678**  
mgto inferior radiador 2.0-16v.  
r.o.

PEUGEOT - 206



**8679**

mgto de calefactor a caja termost. 1.1-1.4-1.6  
r.o.



**8680**

mgto de calefactor a tubo 1.1-1.4-1.6  
r.o.



**8681**

mgto de racor conexión a botella 2.0 HDi  
r.o.



**8682**

mgto de calefactor a caja termostato 2.0 HDi  
r.o.



**8683**

mgto de botella a caja termostato 2.0 HDi  
r.o.



**8684**

mgto de calefactor a caja termost. 2.0-16v.  
r.o.



**8685**

mgto de calefactor a tubo 2.0-16v.  
r.o.



**8755**

mgto de calefactor a racor conexión 2.0 HDi  
r.o.



**8756**

mgto de calefactor a tubo 1.9 D  
r.o.



**8757**

mgto de calefactor a racor conexión 1.9D  
r.o.

PEUGEOT - 206



**3059**  
 racor metálico en culata 1.9 D  
 r.o. 0245.44



**3135**  
 tapa de termostato 2.0 HDi (aluminio)  
 r.o.



**3139**  
 tubo de agua metálico 2.0 HDi con junta  
 tórica, r.o.

**¡Nuevo!**



**3171**  
 boquilla metálica en caja termostato 1.9D  
 r.o. 1336.N7



**3539**  
 tapa de termostato 1.9 D  
 r.o. 1336.C9



**3554**  
 racor conexión manguitos 2.0 HDi  
 r.o.



**3555**  
 racor conexión manguitos 1.9 D  
 r.o.



**3556**  
 tapa de termostato 2.0 HDi (plástico)  
 r.o.



**3560**  
 tapón botella radiador 1.4 bar  
 r.o. 1306.C9



**3620**  
 tapa con termostato 1.1-1.4-1.6  
 r.o. 1336.Q1-1336.N5

**¡Nuevo!**



**3640**  
 tapa bomba de agua 1.6TU  
 r.o. 1201.C3

**¡Nuevo!**



**3641**  
 tapa bomba de agua 1.1-1.4TU  
 r.o. 1201.C2

**¡Nuevo!**



**3656**  
 botella de expansión 1.1-1.4TU  
 r.o. 1323.11-1307.LQ

**¡Nuevo!**



**3657**  
 botella de expansión 1.9D-2.0HDi-2.0EW  
 r.o. 1307.NT-1323.16



**2356** Ø 51 x 58 mm  
 junta de termostato 1.9 D  
 r.o. 1339.92



**SUSPENSION DELANTERA y SOPORTES DE MOTOR todos modelos:**

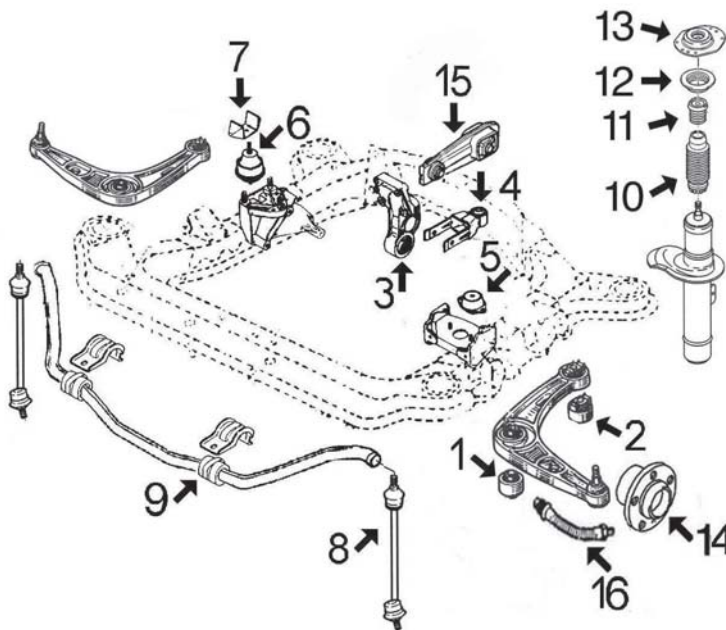

- 1- 4033 silentbloc anterior trapecio delantero
- 2- 4034 silentbloc posterior trapecio delantero
- 3- 4064 silentbloc soporte post. motor 1.1-1.4TU  
4428 silentbloc soporte post. motor 1.4HDi-1.6HDi  
2980 silentbloc soporte posterior motor 1.6, 2.0-16v.,  
1.9D y 2.0 HDi
- 4- 4747 tirante motor trasero completo 1.1-1.4-1.4HDi-1.6-  
1.6HDi  
4748 tirante motor trasero completo 1.9D-2.0HDi-2.0/16v  
2871 silentbloc en tirante posterior de motor
- 5- 2786 soporte motor izquierdo 1.1-1.4-1.6-1.4HDi  
2794 soporte motor izquierdo 1.4i-1.6HDi-2.0/16v-1.9D y  
2.0HDi
- 6- 697 soporte motor derecho 1.1-1.4-1.6  
2309 soporte motor derecho 1.4HDi-1.6HDi-2.0/16v-  
1.9D y 2.0HDi
- 7- 4076 juego limitadores soporte motor derecho 1.1-1.4-1.6  
1.4HDi-1.6HDi-1.4i(D4D)  
4077 juego limitadores soporte motor derecho 2.0-16v.,  
1.9 D y 2.0 HDi
- 8- 4068 bieleta puntal barra estabilizadora
- 9- 4082 goma barra estabilizadora para barra de Ø 18 mm  
4083 goma barra estabilizadora para barra de Ø 19 mm  
4084 goma barra estabilizadora para barra de Ø 20 mm
- 10- 2933 capuchón amortiguador
- 11- 4085 tope poliuretano suspensión
- 12- 4181 rodamiento soporte amortiguador
- 13- 4080 soporte amortiguador derecho todos salvo 1.1  
4669 soporte amortiguador izquierdo todos salvo 1.1  
4483 soporte amortiguador derecho 1.1  
4482 soporte amortiguador izquierdo 1.1
- 14- 90045 buje rueda delant. 1.1-1.4-1.4HDi-1.9D (21 estrías)  
90012 buje rueda delantera 1.6TU-1.6HDi-2.0  
y 2.0HDi (25 estrías)
- 15- 4650 soporte motor trasero 1.4i-(D4D)
- 16- 96187 latiguillo freno delantero (325 mm)

**SUSPENSION TRASERA:**

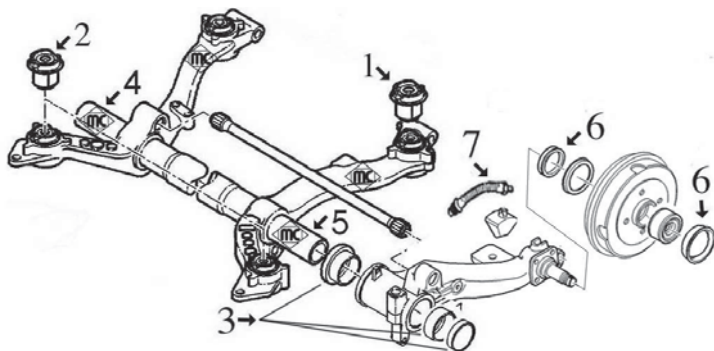

- 1- 4078 silentbloc posterior puente trasero
- 2- 4079 silentbloc anterior puente trasero
- 3- 4583 eje brazo trasero derecho todos modelos
- 4- 4583 eje brazo trasero izquierdo 1.1-1.4-1.4HDi-1.6/8v-  
1.6HDi-1.9D-2.0HDi (salvo CoupéCabriolet)  
4584 eje brazo trasero izquierdo 1.6/16v-2.0/16v y  
CoupéCabriolet todos
- 5- 4438 juego rodamientos, retenes y casquillos  
eje brazo trasero DERECHO e IZQUIERDO 1.1-1.4  
1.6/8v-1.9D-2.0HDi-1.4HDi-1.6HDi  
4438 juego rodamientos, retenes y casquillos  
eje brazo trasero DERECHO 1.6/16v, 2.0/16v y  
CoupéCabriolet
- 4615 juego rodamientos, retenes y casquillos  
eje brazo trasero IZQUIERDO 1.6/16v, 2.0/16v y  
CoupéCabriolet
- 6- 4828 juego retén eje trasero y tapón de tambor
- 7- 96023 latiguillo freno trasero DERECHO (220 mm)  
96161 latiguillo freno trasero IZQUIERDO (270 mm)

PEUGEOT - 206



**697** **HIDRAULICO (650 g.)**  
soporte motor derecho 1.1-1.4-1.6  
r.o. 1844.38-1844.72-1844.75

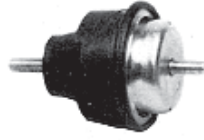

**697/1** **no hidráulico (460 g.)**  
soporte motor derecho 1.1-1.4-1.6  
r.o. ---



**2309** **HIDRAULICO (950 g.)**  
soporte motor derecho 2.0-16v-1.9D y HDi  
r.o. 1844.77



**2309/1** **no hidráulico (610 g.)**  
soporte motor derecho 2.0-16v, 1.9D y HDi  
r.o. ---



**2786**  
soporte motor izquierdo 1.1-1.4-1.6  
r.o. 1844.51



**2794**  
soporte motor izqdo. 2.0-16v, 1.9D y HDi  
r.o. 1844.68



**2871**  
silentbloc tirante posterior motor  
r.o. 1809.22(10x30x28x50)

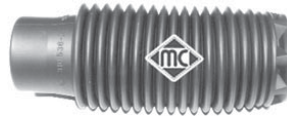

**2933**  
capuchón amortiguador delantero  
r.o. 5254.29-5254.33



**2980**  
silentbloc soporte tras. motor 1.6-2.0-16v  
-1.9D y 2.0HDi, r.o. 1809.21



**4033**  
silentbloc anterior trapecio delantero  
r.o. 3523.76



**4034**  
silentbloc posterior trapecio delantero  
r.o. 3523.77



**4064**  
silentbloc soporte trasero motor 1.1-1.4  
r.o. no hay despiece



**4068**  
bieleta puntal barra estabilizadora  
r.o.

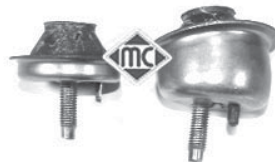

**4076**  
juego limitadores soporte motor derecho  
1.1-1.4-1.6, r.o.



**4077**  
juego limitadores soporte motor derecho  
2.0-16v, 1.9D y 2.0HDi, r.o.



**4078**  
silentbloc posterior puente trasero  
r.o. 5131.94



**4079**  
silentbloc anterior puente trasero  
r.o. 5131.93



**4080**  
soporte amortiguador delantero derecho  
todos salvo 1.1 r.o. 5038.40-5038.38-5038.34



**4082**  
goma para barra estabilizadora de Ø 18 mm  
r.o. 5094.81



**4083**  
goma para barra estabilizadora de Ø 19 mm  
r.o. 5094.80



**4084**  
goma para barra estabilizad. de Ø 20 mm  
r.o. 5094.82

PEUGEOT - 206



**4085**  
tope poliuretano suspensión delantera  
r.o.5033.58



**4181**  
rodamiento soporte amortiguador delantero  
r.o.5035.27

**¡Nuevo!**



**4428**  
silentbloc soporte trasero motor 1.4HDI  
1.6HDI,r.o.1806.33-1809.35

**¡Nuevo!**



**4438**  
juego rodamientos retenes y casquillos eje  
brazo trasero, r.o.

**¡Nuevo!**



**4482**  
soporte amortiguador delantero izqd. 1.1  
r.o.5038.95

**¡Nuevo!**



**4483**  
soporte amortiguador delantero dcho. 1.1  
r.o.5038.99

**¡Nuevo!**



**4583**  
eje brazo trasero suspensión  
r.o.

**¡Nuevo!**



**4584**  
eje brazo trasero suspensión  
r.o.

**¡Nuevo!**



**4615**  
juego rodamientos retenes y tapón eje  
brazo trasero, r.o.

**¡Nuevo!**



**4650**  
bieleta soporte motor trasero 1.4i motor D4D  
r.o.1806.56

**¡Nuevo!**



**4669**  
soporte amortiguador delantero izqd. todos  
salvo 1.1,r.o.5038.C5-5038.54-5038.56

**¡Nuevo!**



**4828**  
juego retén eje trasero y tapón de tambor  
r.o.3724.24+3740.19



**90045**  
bujes rueda delantera 1.1-1.4-1.4HDI-1.9D  
(21 estrías), r.o.3307.76



**90012**  
bujes rueda delantera 1.6-2.0-1.6HDI-2.0HDI  
(25 estrías), r.o.3307.72



**96187**  
latiguillo freno delantero (325 mm)  
r.o.4806.92



**96023**  
latiguillo freno trasero **derecho** (220 mm)  
r.o.4806.94



**96161**  
latiguillo freno trasero **izquierdo** (270 mm)  
r.o.4806.93

ARTICULACIONES PALANCA DE CAMBIO

1.1TU - 1.4TU - 1.6TU - 1.4HDi (CAMBIO MA):

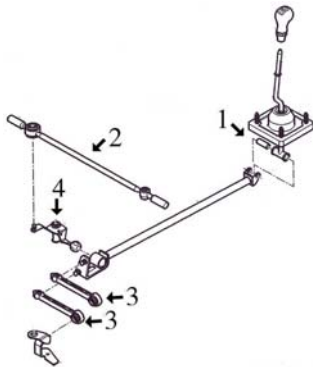

- 1- 2400 casquillo base palanca de cambio
- 2- 4200 bieleta mando reenvio cambio
- 3- 4081 bieleta mando reenvio cambio
- 4- 4989 articulación reenvio cambio

1.9 Diesel - 2.0 HDi (CAMBIO BE4R por palancas)

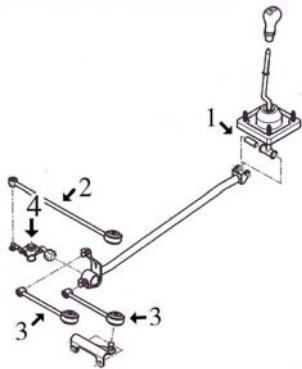

- 1- 2400 casquillo base palanca de cambio
- 2- 4420 bieleta mando reenvio cambio
- 3- 2865 bieleta mando reenvio cambio
- 4- 4991 articulación reenvio cambio

1.6HDi - 2.0/16v. (CAMBIO BE4R por cables)

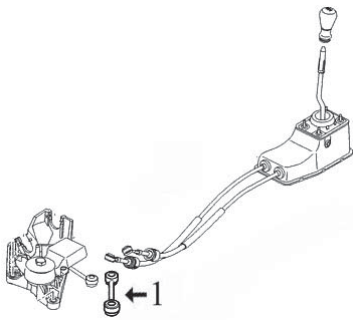

- 1- 4620 bieleta mando reenvio cambio



**2400**  
casquillo base palanca de cambio  
r.o.



**2865**  
bieleta reenvio 1.9D-2.0 HDi y 2.0-16v.  
r.o. 2454.F0-2454.G4



**4420**  
bieleta reenvio 1.9D-2.0 HDi  
r.o. 2452.81

rótulas de 10 y 13 mm



**4081**  
bieleta reenvio mando cambio 1.1-1.4-1.6  
r.o. 2452.F2



**4200**  
bieleta reenvio mando cambio 1.1-1.4-1.6  
r.o. 2452.91 - 2452.82























rótulas de 10 y 13 mm























**4602**  
bieleta reenvio cambio 1.6HDi y 2.0/16v  
r.o.



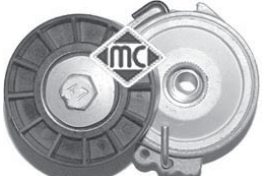

PEUGEOT - 206

<p><b>4989</b> articulación reenvío cambio 1.1-1.4-1.6-1.4HDi (cambio MA), r.o.</p> 	<p><b>4991</b> articulación reenvío cambio 1.9D-2.0HDi (cambio BE4R), r.o.</p> 	
<p><b>4066</b> horquilla embrague 1.9D-2.0HDi-2.0/16v y 1.4i (D4D), r.o. 2117.58</p> 	<p><b>4600</b> horquilla embrague 1.4HDi r.o. 2117.61</p> 	<p><b>4601</b> horquilla embrague 1.6HDi r.o. 2117.66-2117.57</p> 
<p><b>4800</b> horquilla embrague 1.1-1.4-1.6TU r.o. 2117.56</p> 	<p><b>4424</b> altura 55,50 mm casquillo guía embrague cambio MA (motores TU) hasta 6/00, r.o. 2105.14</p> 	<p><b>4796</b> altura 56,50 mm casquillo guía embrague cambio MA (motores TU+1.4HD) desde 6/00, r.o. 2105.38</p> 
<p><b>4605</b> casquillo guía embrague motores EW, DW y 1.6HDi, r.o. 2105.35</p> 	<p><b>4057</b> juego casquillos horquilla embrague 1.1-1.4-1.4HDi-1.6, r.o. 2175.11+2175.12</p> 	<p><b>2931</b> tensor correa alternador 1.9 Diesel r.o. 5751.81</p> 
<p><b>3639</b> tapón llenado aceite 1.1-1.4TU r.o.</p> 	<p><b>3642</b> tapón llenado aceite 1.9D-2.0HDi-1.4HDi-1.6HDi, r.o. 1180.F9</p> 	<p><b>3659</b> tapón llenado aceite 1.6/16v r.o. 0258.65</p> 
<p><b>4593</b> varilla nivel aceite 1.1-1.4TU r.o.</p> 	<p><b>2335</b> varilla nivel aceite 1.6TU r.o.</p> 	<p><b>4739</b> varilla nivel aceite 1.6/16v (TU5JP4) r.o.</p> 
<p><b>4740</b> varilla nivel aceite 1.4HDi r.o.</p> 	<p><b>4741</b> varilla nivel aceite 1.6HDi r.o.</p> 	<p><b>4596</b> varilla nivel aceite 1.9DW8 r.o.</p> 

PEUGEOT - 206

<p><b>¡Nuevo!</b></p>  <p><b>4594</b> varilla nivel aceite 2.0HDi r.o.</p>	<p><b>¡Nuevo!</b></p>  <p><b>3651</b> tapa filtro de gasoil 1.9DW8 con junta y clip de cerrar, r.o. 1904.26+1904.27</p>	<p><b>¡Nuevo!</b></p>  <p><b>4479</b> jgo soportes tapa motor 2.0HDi r.o.0137.11+0137.23</p>
 <p><b>2927</b> polea cigueñal 1.9 Diesel sin aire ac. hasta 12/03, r.o.0515.L7</p>	 <p><b>2928</b> polea cigueñal 2.0 HDi hasta 6/02 y 1.9D c/aire acond. r.o.0515.P2</p>	<p><b>¡Nuevo!</b></p>  <p><b>4477</b> polea cigueñal 2.0 HDi desde 6/02 r.o.0515.S4</p>
<p><b>¡Nuevo!</b></p>  <p><b>4610</b> polea cigueñal 1.9 Diesel sin aire ac. desde 12/03, r.o.0515.R5</p>	<p><b>¡Nuevo!</b></p>  <p><b>4440</b> polea cigueñal 1.1-1.4TU-1.4/16v r.o.0515.P5</p>	<p><b>¡Nuevo!</b></p>  <p><b>4441</b> polea cigueñal 1.4HDi-1.6HDi r.o.0515.P8-0515.R0</p>
<p><b>¡Nuevo!</b></p>  <p><b>4442</b> polea cigueñal 1.6/16v (TU5JP4) r.o.0515.S1-0515.P1</p>	<p><b>¡Nuevo!</b></p>  <p><b>4443</b> polea cigueñal 2.0/16v hasta '02 r.o.0515.N3</p>	<p><b>¡Nuevo!</b></p>  <p><b>4562</b> polea cigueñal 2.0/16v desde '02 r.o.0515.R1</p>
<p><b>¡Nuevo!</b></p>  <p><b>4826</b> tensor correa alternador 1.9DW8 r.o.5751.30</p>	<p><b>¡Nuevo!</b></p>  <p><b>5043</b>      <b>rodillo de Ø 60 mm</b> tensor correa alternador 1.9DW8 sin A/C desde 9/99-, r.o.5751.74</p>	<p><b>¡Nuevo!</b></p>  <p><b>4807</b>      <b>rodillo de Ø 70 mm</b> tensor correa alternador 2.0HDi r.o.5751.55</p>
<p><b>¡Nuevo!</b></p>  <p><b>3697</b> juego tapas correa distribución 1.1TU-1.4TU r.o.0320.S2+0320.L3</p>	<p><b>¡Nuevo!</b></p>  <p><b>3700</b> juego tapas correa distribución 1.9DW8 r.o.0320.N3+0320.X6+0320.N4</p>	<p><b>¡Nuevo!</b></p>  <p><b>3699</b> juego tapas correa distribución 2.0HDi r.o.0320.N5+0320.N6+0320.S7</p>
<p><b>¡Nuevo!</b></p>  <p><b>4928</b>      <b>rodillo tensor correa alternador XUD-1.9DW sin A/C, r.o.5751.73</b></p>	<p><b>¡Nuevo!</b></p>  <p><b>4995</b> rodillo tensor correa alternador 1.9DW8 y 2.0HDi con A/C, r.o.5751.29</p>	<p><b>¡Nuevo!</b></p>  <p><b>4996</b> rodillo tensor correa alternador 2.0HDi sin A/C, r.o.5751.96-5751.57</p>

PEUGEOT - 206

<p><b>¡Nuevo!</b></p>  <p><b>4915</b> Ø 54,60 mm polea de alternador de rueda libre r.o.</p>	<p><b>¡Nuevo!</b></p>  <p><b>4916</b> Ø 58,50 mm polea de alternador de rueda libre r.o.</p>	
<p><b>¡Nuevo!</b></p>  <p><b>1109</b> kit rep. transmisión l/rda. 1.1-1.4-1.6/8v desde 12/02, r.o. 3293.35</p>	<p><b>¡Nuevo!</b></p>  <p><b>1113</b> kit rep. transm. l/rda. 1.9D-2.0HDi-1.6HDi 2.0/16v-1.6/16v, desde 2/01, r.o. 3293.31</p>	<p><b>¡Nuevo!</b></p>  <p><b>4564</b> Ø 30/47 y 40/58 mm juego retenes diferencial-transmisión r.o. 3121.44+3121.46</p>
 <p><b>1428</b> kit rep. transmisión l/cbo. 1.1-1.4-1.6-1.4HDi-1.6HDi, r.o. 3287.88</p>	 <p><b>1222</b> kit rep. transm. l/rda. 1.9D-2.0HDi-1.6HDi 2.0/16v-1.6/16v, hasta 2/01, r.o. 3293.03</p>	 <p><b>1213</b> kit rep. transmisión l/cbo. 1.9D-2.0HDi y 2.0-16v., r.o. 3287.81</p>
 <p><b>1479</b> fuelle cremallera manual r.o.</p>	 <p><b>1480</b> fuelle cremallera asistida r.o.</p>	 <p><b>1427</b> kit rep. transmisión l/rda. 1.1-1.4-1.6/8v hasta 12/02, r.o. 3293.20</p>
 <p><b>2938</b> junta de Ø 58 x 45 mm kit montaje colector 1.9 Diesel r.o.</p>	 <p><b>2940</b> junta de Ø 80 x 66 mm kit montaje colector 2.0-16v. r.o.</p>	 <p><b>4065</b> junta de Ø 58 x 46 mm kit montaje colector 1.1-1.4-1.6 r.o.</p>
 <p><b>2692</b> soporte escape todos r.o. 1755.58</p>	 <p><b>2753</b> soporte silenciador trasero 2.0 HDi r.o. 1755.69</p>	<p><b>¡Nuevo!</b></p>  <p><b>4445</b> soporte escape 1.4HDi-1.6HDi r.o. 1755.F9</p>
 <p><b>016</b> tapón cierre inyectores Diesel r.o.</p>	 <p><b>667</b> tapón cárter 16x150 r.o. 0163.93</p>	 <p><b>2452</b> tapón cárter 14x125 r.o. 0311.25</p>

## PEUGEOT - 206



**2929**  
tapón cárter de aceite 1.9 Diesel, M-10  
r.o.0311.29



**2050** **14 x 22 mm**  
arandela metaloplástica para tapón HDi  
r.o.0313.27



**2024**  
arandela metal-goma 14 mm  
r.o.



**4036**  
bomba manual cebado gasoil con válvula  
antirretorno y boquilla adicional a 90°



**2051**  
arandela plana 10 x 21 para tapón MC-2929  
r.o.0313.33



**4069**  
cubrepedal freno y embrague  
r.o.2130.18



CANALIZACIONES DE AGUA

306 1.4 y 1.6 motor TU (motores TU3MC de 1360 cc y TU5JP de 1587 cc):

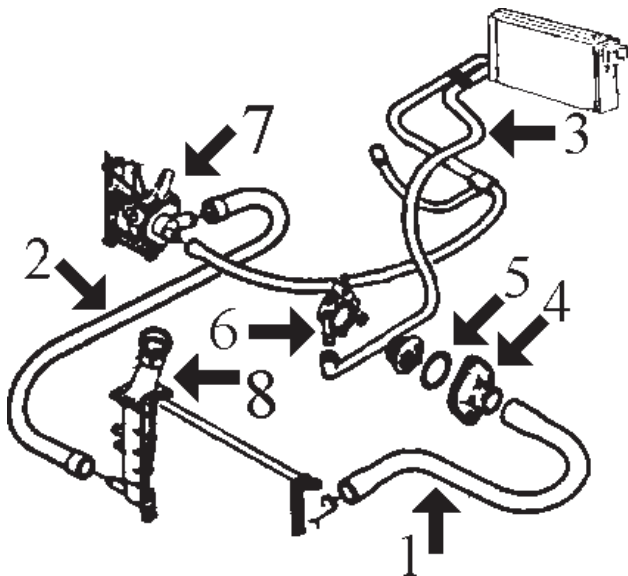

- 1- 8266 mgto superior radiador 1.4 sin aire acondicionado hasta '98
- 8606 mgto superior radiador 1.4-1.6 sin aire acondicionado desde '98
- 8298 mgto superior radiador 1.4 con aire acond. y 1.6 todos hasta '98
- 8607 mgto superior radiador 1.4-1.6 con aire acondicionado desde '98
- 2- 8265 mgto inferior radiador 1.4 y 1.6 hasta '98
- 8476 mgto inferior radiador 1.4 y 1.6 desde '97
- 2113 junta tórica conector rápido mgto inferior hasta '98
- 3- 8300 mgto doble de calefactor 1.4 hasta '98
- 8302 mgto doble de calefactor 1.6 hasta '98
- 8535 mgto doble de calefactor 1.6 desde '98
- 4- 3011 tapa de termostato hasta '98
- 3611 tapa con termostato desde '98
- 5- 2351 junta de termostato hasta '98
- 6- 3081 boquilla metálica caja termostato Ø 16 mm
- 3082 boquilla metálica caja termostato Ø 10 mm
- 7- 3578 tapa bomba de agua (plástico) 1.4 hasta 9/'00
- 3641 tapa bomba de agua (plástico) 1.4 desde 9/'00
- 3640 tapa bomba de agua (plástico) 1.6 desde 9/'00
- 8- 3548 tapón botella expansión (1.4 bar)
  
- 8167 mgto desvaporizador 1.4
- 8002 mgto desvaporizador 1.4
- 8541 mgto desvaporizador 1.6
- 8542 mgto desvaporizador 1.6

306 1.8 - 2.0 y 2.0-16v (motores XU7JP de 1761 cc, XU10J2 de 1998 cc y XU10J4)

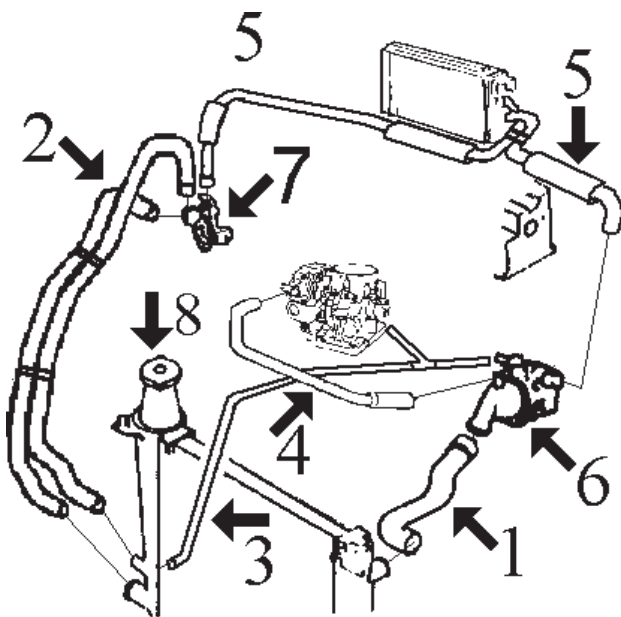

- 1- 8295 mgto superior radiador hasta '98
- 8608 mgto superior radiador desde '97
- 8609 mgto superior radiador 1.8-16v y 2.0-16v desde '98
- 2- 8292 mgto inferior radiador hasta '95 (doble)
- 8294 mgto inferior radiador desde '95
- 8477 mgto inferior radiador desde '98
- 2113 junta tórica conector rápido mgto inferior hasta '98
- 3- 8306 mgto de radiador a caja termostato hasta '98
- 4- 8301 mgto doble de calefactor hasta '98
- 8610 mgto doble de calefactor desde '98
- 5- 3538 tapa de termostato
- 2351 junta de termostato Ø 41x47
- 3077 boquilla metálica en caja termostato Ø 19 mm
- 3078 boquilla metálica en caja termostato Ø 10 mm
- 6- 3523 brida agua conexión mgto
- 7- 3578 tapa bomba de agua
- 8- 3548 tapón radiador (1.4 bar)
  
- 8549 mgto desvaporizador
- 8550 mgto desvaporizador
- 8854 mgto desvaporizador

306 1.9 Diesel de '93 a '98 (motor XUD9)

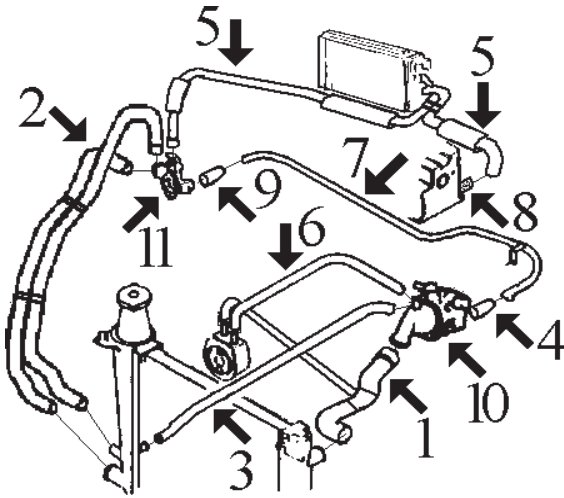

- 1- 8268 mgto superior radiador
- 2- 8230 mgto inferior radiador hasta '95 (doble)  
8294 mgto inferior radiador desde '95 (grapas perpendiculares al plano del tubo)
- 8998 mgto inferior radiador desde '95 (grapas horizontales al plano del tubo)
- 2113 junta tórica conector rápido mgto inferior
- 3- 8306 mgto de radiador a caja de termostato
- 4- 8183 mgto de caja termostato a tubo metálico
- 5- 8303 mgto doble de calefactor
- 6- 8313 mgto de intercambiador a caja termostato
- 7- 3057 tubo metálico
- 8- 3059 boquilla en culata
- 9- 8312 mgto de tubo metálico a brida conexión mgto.
- 10- 3539 tapa de termostato  
2361 junta de termostato Ø 51x58 mm  
3171 boquilla en caja termostato
- 11- 3503 brida agua conexión mgto.

306 1.9 TurboDiesel de '93 a '98 (motor XUD9TE)

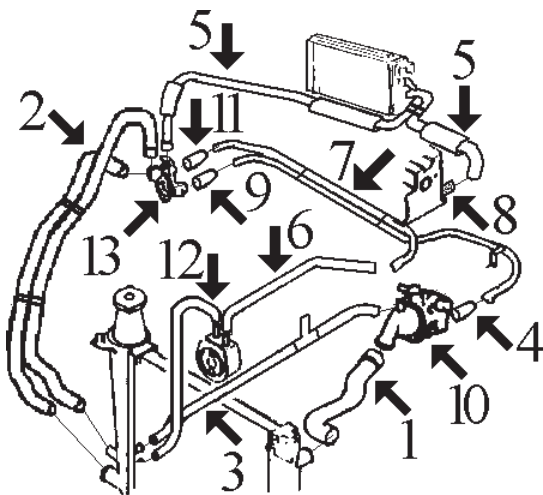

- 1- 8297 mgto superior radiador
- 2- 8294 mgto inferior radiador desde '95 (grapas perpendiculares al plano del tubo)
- 8998 mgto inferior radiador desde '95 (grapas horizontales al plano del tubo)
- 2113 junta tórica conector rápido mgto inferior
- 3- 8321 mgto degasificador de radiador a caja termostato (tramo de 3ª vía a culata, cortar de rollo MC-116 Ø 8x14 mm, longitud 500 mm)
- 4- 8183 mgto de caja termostato a tubo metálico
- 5- 8303 mgto doble de calefactor
- 6- 8314 mgto de intercambiador a tubo metálico
- 7- n/d tubo metálico doble
- 8- 3059 boquilla en culata
- 9- 8316 mgto de tubo metálico a caja entrada
- 10- 3539 tapa de termostato  
2361 junta de termostato Ø 51x58 mm  
3171 boquilla en caja termostato
- 11- 8312 mgto de tubo metálico a caja entrada
- 12- 8315 mgto de radiador a intercambiador
- 13- 3503 brida agua conexión mgto.

306 1.9 Diesel y TurboDiesel de '98 a '99 (motores XUD9 y XUD9TE)

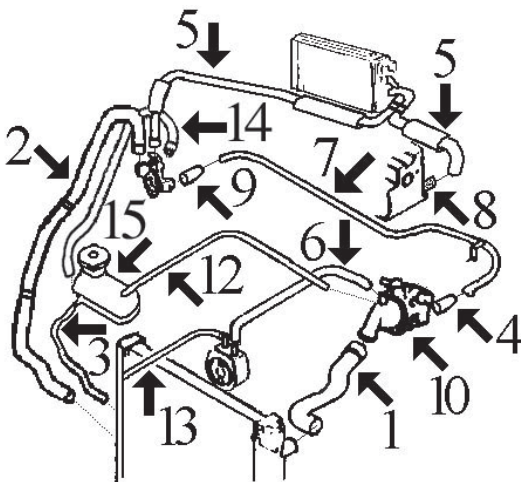

- 1- 8437 mgto superior radiador
- 2- 8611 mgto inferior radiador
- 3- 116 mgto de radiador a botella, cortar de rollo MC-116 Ø 8 x 14 mm, longitud 200 mm.
- 4- 8480 mgto de caja termostato a tubo metálico
- 5- 8613 mgto doble de calefactor
- 6- 8313 mgto de intercambiador a caja termostato
- 7- 3057 tubo metálico
- 8- 3059 boquilla en culata
- 9- 8312 mgto de tubo metálico a brida conexión mgto.
- 10- 3539 tapa de termostato  
2361 junta de termostato Ø 51x58 mm  
3171 boquilla en caja termostato
- 11- 3503 brida agua conexión mgto.
- 12- 8616 mgto de botella a caja termostato
- 13- 8438 mgto de intercambiador a radiador
- 14- 8612 mgto de radiador a racor
- 15- 3653 botella de expansión  
3548 tapón botella expansión 1.4 bar

306 Diesel desde '99 (motor DW8)

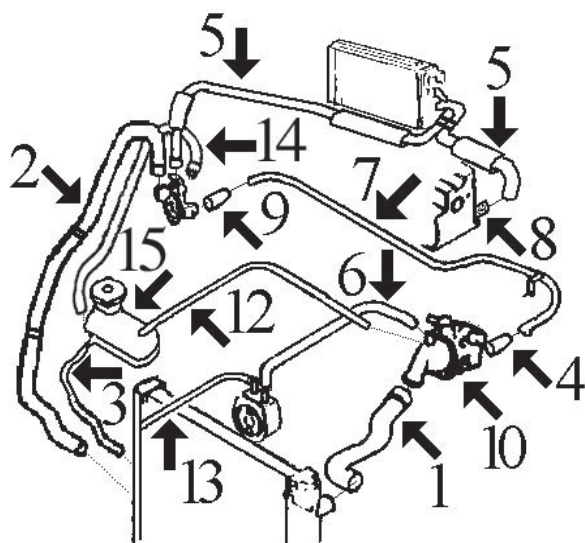

- 1- 8437 mgto superior radiador
- 2- 8611 mgto inferior radiador
- 3- 116 mgto de radiador a botella, cortar de rollo MC-116 Ø 8 x 14 mm, longitud 200 mm.
- 4- 8480 mgto de caja termostato a tubo metálico
- 5- 8613 mgto doble de calefactor
- 6- 8558 mgto de intercambiador a caja termostato
- 7- 3057 tubo metálico
- 8- 3059 boquilla en culata
- 9- 8312 mgto de tubo metálico a brida conexión mgto.
- 10- 3539 tapa de termostato  
2361 junta de termostato 51x58 mm  
3171 boquilla en caja termostato
- 11- 3544 brida agua conexión mgto.
- 12- 8616 mgto de botella a caja termostato
- 13- 8481 mgto de intercambiador a radiador
- 14- 8612 mgto de radiador a racor
- 15- 3653 botella de expansión  
3548 tapón botella expansión 1.4 bar

306 2.0 HDi (motor DW10)

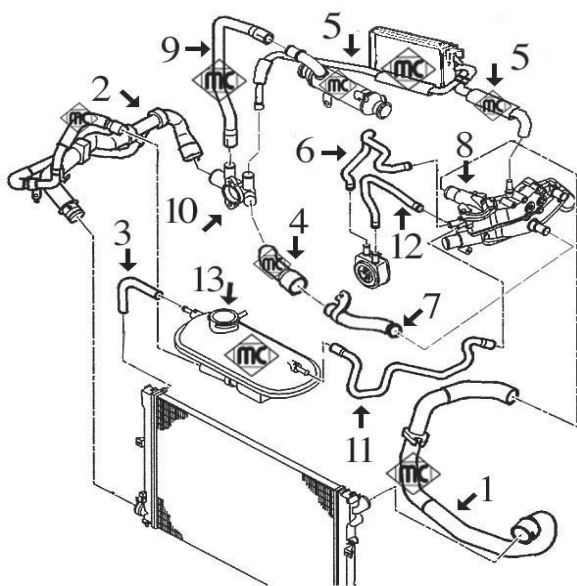

- 1- 8553 mgto sup. radiador
- 2- 8614 mgto inferior radiador
- 3- 116 mgto de botella a radiador, cortar de rollo MC-116, Ø 8x14 longitud 250 mm.
- 4- 8575 mgto de tubo metálico a racor entrada
- 5- 8615 mgto doble de calefactor
- 6- 8585 mgto de intercambiador a caja termostato
- 7- 3139 tubo metálico con junta tórica
- 8- 3135 tapa de termostato (aluminio)  
3556 tapa de termostato (plástico)
- 9- 8668 mgto de racor a filtro de partículas
- 10- 3544 racor plástico conexión manguitos
- 11- 8617 mgto de botella a caja termostato
- 12- 8586 mgto de intercambiador a caja termostato
- 13- 3653 botella de expansión  
3548 tapón botella de expansión 1.4 bar

MGTOS DESVAPORIZADORES Diesel y TurboDiesel:

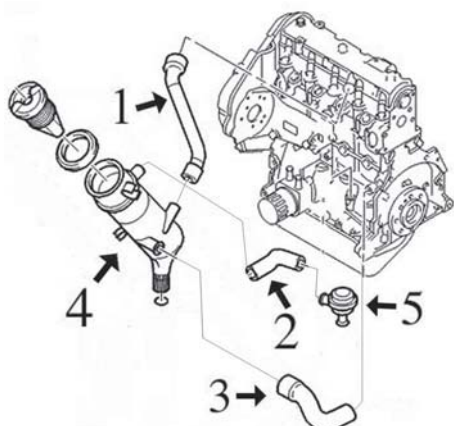

- 1- 8307 mgto de tapa balancines a decantador motores XUD  
8475 mgto de tapa balancines a colector motor 1.9 DW8  
8539 mgto de tapa balancines a colector motor 2.0 HDi
- 2- 8167 mgto de decantador a filtro de aire motor 1.9 XUD
- 3- 8166 mgto de cárter a decantador motores 1.9 XUD  
8474 mgto de cárter a culata motor 1.9 DW8  
8540 mgto de cárter a culata motor 2.0 HDi
- 4- 3631 decantador completo con tapón 1.9XUD-1.9XUDTE
- 5- 3637 valvula reguladora

PEUGEOT - 306



**8002**  
mgto desvaporizador 1.4 TU  
r.o. 1191.20-1192.62



**8166**  
mgto desvaporizador Diesel y TurboD  
r.o. 1192.48



**8167**  
mgto desvaporizador Diesel y 1.4 TU  
r.o. 1180.A3-1192.61



**8183**  
mgto de termostato a tubo metálico D y TD  
r.o. 1307.W3



**8230**  
mgto inferior radiador Diesel hasta '95  
r.o. 1351.K3



**8265**  
mgto inferior radiador 1.4-1.6 motor TU  
r.o. 1351.J4



**8266**  
mgto superior radiador 1.4 sin aire acond.  
r.o. 1343.J2-1343.V6



**8268**  
mgto superior radiador Diesel  
r.o. 1343.V5



**8292**  
mgto inferior radiador 1.8-2.0-16v. h/'95  
r.o. 1351.H8-1351.K3



**8294**  
mgto infradiador 1.8-2.0-D-TD  
(grapas perpendiculares al plano del tubo)



**8295**  
mgto superior radiador 1.8-2.0 hasta '98  
r.o. 1343.H7



**8297**  
mgto superior radiador TurboDiesel  
r.o. 1343.K2



**8298**  
mgto sup. radiador 1.4 aire ac. y 1.6 todos  
r.o. 1343.J3



**8300**  
mgto doble de calefactor 1.4  
r.o. 6464.S3



**8301**  
mgto doble de calefactor 1.8-2.0  
r.o. 1351.Q1



**8302**  
mgto doble de calefactor 1.6  
r.o. 6464.KX



**8303**  
mgto doble de calefactor Diesel y TurboD  
r.o. 6464.NG-6464.FZ



**8306**  
mgto de radiador a termostato 1.8-2.0 y D  
r.o. 1341.75-1307.JE-1341.86-1351.K8



**8307**  
mgto desvaporizador Diesel y TurboDiesel  
r.o. 1180.86



**8308**  
mgto desvaporizador TurboDiesel  
r.o. 1180.A5



PEUGEOT - 306



**8312**  
mgto de tubo metálico a brida agua Diesel y TurboDiesel, r.o. 1307.W4



**8313**  
mgto de intercambiador a termostato Diesel r.o. 1307.AA



**8314**  
mgto de intercambiador a tubo metalico TurboDiesel, r.o. 1307.Y3-1307.JC



**8315**  
mgto de radiador a intercambiador TurboD r.o. 1307.Y2



**8316**  
mgto de tubo metálico a brida agua TurboD r.o. 1307.X9



**8321**  
mgto de radiador a termost. Diesel y TD r.o. 1351.M3



**8437**  
mgto superior radiador 1.9 D-TD desde '98 r.o. 1343.X2



**8438**  
mgto intercambiador a radiador r.o. 1307.JP



**8474**  
mgto desvaporizador 1.9 DW8 r.o.



**8475**  
mgto desvaporizador 1.9 DW8 r.o.



**8476**  
mgto inferior radiador 1.4-1.6 desde '98 r.o.



**8477**  
mgto inferior radiador 1.8-2.0 desde '98 r.o.



**8480**  
mgto de caja termostato a tubo metálico 1.9 r.o.



**8481**  
mgto de intercambiador a radiador 1.9DW8 r.o.



**8535**  
mgto calefactor 1.4 desde '98 r.o.



**8539**  
mgto desvaporizador 2.0 HDi r.o.



**8540**  
mgto desvaporizador 2.0 HDi r.o.



**8541**  
mgto desvaporizador 1.6 r.o.



**8542**  
mgto desvaporizador 1.6 r.o.



**8549**  
mgto desvaporizador 1.8 r.o.



**8550**  
mgto desvaporizador 1.8 r.o.

## PEUGEOT - 306



**8553**  
mgto superior radiador 2.0 HDi  
r.o.



**8558**  
mgto de intercambiador a caja termostato  
r.o.



**8575**  
mgto de tubo metálico a racor 2.0 HDi  
r.o.



**8585**  
mgto de intercambiador a termostato 2.0 HDi  
r.o.



**8586**  
mgto de intercambiador a termost. 2.0 HDi  
r.o.



**8606**  
mgto sup radiador 1.4-1.6 desde '98  
r.o.



**8607**  
mgto sup radiador 1.4-1.6 desde '98  
r.o.



**8608**  
mgto sup radiador 1.8-2.0 desde '98  
r.o.



**8609**  
mgto sup radiador 1.8-16v - 2.0-16v  
r.o.



**8610**  
mgto doble calefactor 1.8-2.0 desde '98  
r.o.



**8611**  
mgto inferior radiador 1.9 D-TD  
r.o.



**8612**  
mgto de radiador a racor 1.9 DW8  
r.o.



**8613**  
mgto doble calefactor 1.9 DW8  
r.o.



**8614**  
mgto inferior radiador 2.0 HDi  
r.o.



**8615**  
mgto doble calefactor 2.0 HDi  
r.o.



**8616**  
mgto de botella a caja termostato 1.9 D-TD  
r.o.



**8617**  
mgto de botella a caja termostato 2.0 HDi  
r.o.



**8668**  
mgto de racor a filtro de partículas 2.0 HDi  
r.o.



**8854**  
mgto desvaporizador 1.8i  
r.o. 1180.62



**8998**  
mgto inf radiador 1.9 D/TD  
(grapas horizontales al plano del tubo)

PEUGEOT - 306



**3011**  
tapa de termostato 1.4-1.6 (motores TU)  
r.o. 1336.44



**3057**  
tubo metálico Diesel  
r.o. 1307.W2



**3059**  
boquilla en culata Diesel y TurboDiesel  
r.o. 0245.42



**3077** Ø 20 mm  
boquilla en caja termostato 1.8-2.0-16v.  
r.o. 1341.63



**3078**  
boquilla en caja termostato 1.8-2.0-16v.  
r.o. 1336.K8



**3081** Ø 15,5 mm  
boquilla en caja termostato 1.4-1.6  
r.o.



**3082** Ø 10 mm  
boquilla en caja termostato 1.4-1.6  
r.o.



**3135**  
tapa de termostato 2.0 HDi  
r.o. 1336.P2



**3139**  
tubo de agua metálico 2.0 HDi con junta  
tórica, r.o. 1307.YZ



**3171**  
boquilla metálica en caja termostato 1.9D-TD  
r.o. 1336.N7

## PEUGEOT - 306



**3503**  
brida agua conexión mgts Diesel y TurboD  
con junta tórica, r.o. 1336.G4 + 1340.28

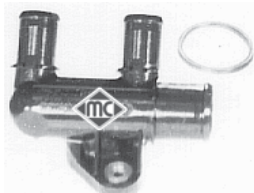

**3523**  
brida agua conexión mgts 1.8-2.0 con  
junta tórica, r.o. 1336.H7 + 1339.79



**3538**  
tapa de termostato 1.8-2.0  
r.o. 1336.A1



**3539**  
tapa de termostato Diesel y TurboD  
r.o. 1336.C9



**3544**  
racor conexión mgto agua 1.9 DW8-2.0 HDi  
r.o. 1336.P0-1336.Q3



**3548**  
tapón de radiador/botella expansión 1.4 bar  
r.o. 1336.C7-1336.84



**3556**  
tapa de termostato 2.0 HDi (plástico)  
r.o. 1336.R9



**3578**  
tapa bomba de agua 1.4 TU con junta tórica  
hasta 9/'00, r.o. 1201.66



**3611**  
tapa con termostato 1.4 desde '97  
r.o. 1336.Q2



**3631**  
decantador completo con tapón 1.9D-TD  
r.o. 1180.95

**¡Nuevo!**



**3637**  
válvula reguladora desvaporizada. 1.9D-TD  
r.o. 0361.58

**¡Nuevo!**



**3640**  
tapa bomba de agua conexión mgts 1.6 TU  
r.o. 1201.C3

**¡Nuevo!**



**3641**  
tapa bomba de agua 1.4 TU con junta tórica  
desde 9/'00, r.o. 1201.66

**¡Nuevo!**



**3653**  
botella de expansión  
r.o. 1307.JG-1307.JF-1307.QN-1307.RL

**¡Nuevo!**



**4490**  
soporte desvaporizador 1.8i  
r.o. 1439.10



**2361** Ø 51 x 58  
junta de termostato Diesel  
r.o.



**2351** Ø 41 x 47  
junta de termostato TurboD  
r.o.



**SUSPENSION DELANTERA y SOPORTES DE MOTOR todos modelos:**

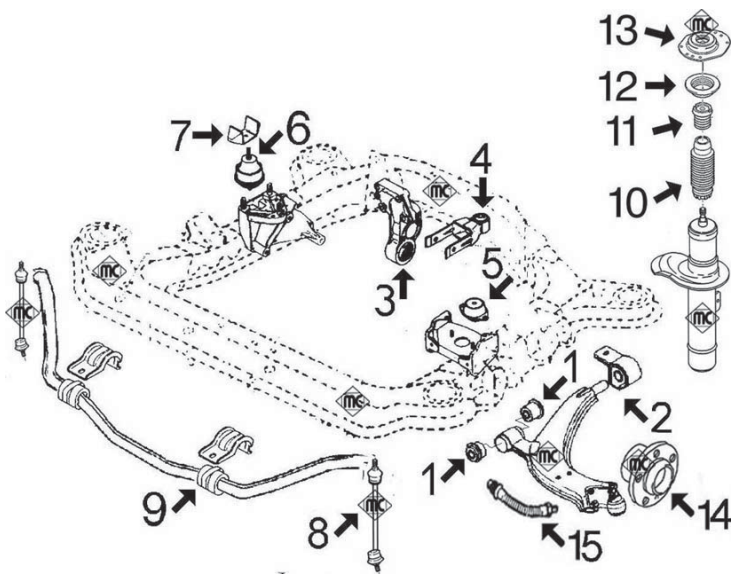

- 1- 962 silentbloc anterior trapecio delantero
- 2- 979 silentbloc posterior trapecio delantero
- 3- 751 silentbloc soporte post. motor 1.4 hasta '95
- 4064 silentbloc soporte post. motor 1.4 desde '95
- 2869 silentbloc soporte posterior motor 1.8 gasolina y 1.9 Diesel hasta '98
- 2980 silentbloc soporte posterior motor 1.9 D desde '98 y 2.0 HDi
- 4- 4743 tirante posterior motor completo 1.4TU-1.6TU
- 4745 tirante post. motor completo 1.8-1.9D/TD-2.0HDi
- 877 silentbloc tirante posterior de motor 1.4
- 2871 silentbloc tirante posterior de motor 1.8 y Diesel
- 5- 2786 soporte izquierdo de motor 1.4
- 531 soporte izquierdo de motor 1.8
- 2794 soporte izquierdo de motor 2.0, Diesel y TurboD
- 6- 697 soporte derecho motor 1.4-1.6 y 1.8
- 2309 soporte derecho motor 2.0 y Diesel
- 7- 2884 limitador superior soporte derecho motor
- 8- 4053 bieleta puntal barra estabilizadora
- 9- 2411 goma barra estabilizadora para barra de Ø 18 mm
- 2412 goma barra estabilizadora para barra de Ø 21 mm
- 2691 goma barra estabilizadora para barra de Ø 24 mm
- 10- 2933 capuchón amortiguador
- 11- 2975 tope poliuretano suspensión
- 12- 4181 rodamiento soporte amortiguador
- 13- 2935 soporte amortiguador
- 14- 90013 buje rueda delantera 1.4 sin ABS
- 90014 buje rueda delantera 1.4 con ABS -1.6-1.8-1.9-Diesel-TurboD y HDi
- 15- 96099 latiguillo freno delantero (535 mm)

**BRAZOS SUSPENSION TRASERA**

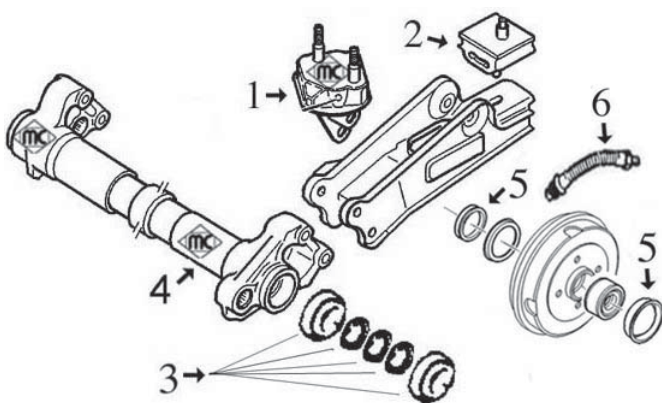

- 1- 2978 soporte anterior brazo trasero izquierdo
- 2977 soporte anterior brazo trasero derecho
- 2- 2694 soporte posterior brazo trasero
- 3- 4413 jgo. reparación brazo trasero completo con rodamientos
- 4- 4550 eje brazo trasero (derecho e izquierdo)
- 5- 4828 juego retén eje trasero y tapón tambor
- 6- 96031 latiguillo freno trasero (265 mm)

## PEUGEOT - 306



**531**  
soporte motor izquierdo 1.8  
r.o. 1843.95

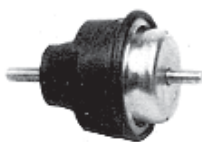

**697**      **HIDRAULICO (650 g.)**  
soporte de motor derecho 1.4 y 1.8  
r.o. 1844.38

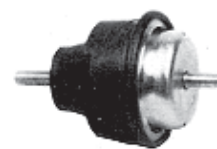

**697/1**      **no hidráulico (460 g.)**  
soporte de motor derecho 1.4 y 1.8  
r.o. ----



**751**  
silentbloc soporte posterior motor 1.4  
r.o.

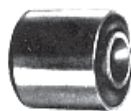

**877**  
silentbloc tirante posterior motor 1.4  
r.o. 1809.04



**962**  
silentbloc anterior trapecio delantero  
r.o. no hay despiece

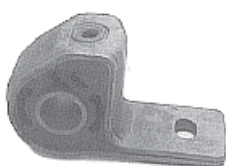

**979**  
silentbloc posterior trapecio delantero  
r.o.



**2309**      **HIDRAULICO (950 g.)**  
soporte de motor derecho 2.0-16v-D y TD  
r.o. 1844.47-1843.73



**2309/1**      **no hidráulico (610 g.)**  
soporte de motor derecho 2.0-16v-D y TD  
r.o. ---



**2411**      **con ánima metálica !**  
goma para barra estabilizadora de Ø 18 mm  
r.o. 5094.64



**2412**      **con ánima metálica !**  
goma para barra estabilizadora de Ø 21 mm  
r.o. 5094.65



**2691**      **con ánima metálica !**  
goma para barra estabiliz. de Ø 24 mm  
r.o.



**2694**  
soporte brazo trasero suspensión  
r.o. 5131.71



**2786**  
soporte motor izquierdo 1.4-1.6  
r.o. 1844.51



**2794**  
soporte motor izquierdo 2.0 -D y TD  
r.o. 1827.10



**2869**  
silentbloc tirante posterior motor 1.8-1.9D  
r.o. 1809.16



**2871**  
silentbloc tirante posterior motor 1.8-1.9D  
r.o. 1809.22



**2884**  
limitador soporte motor derecho  
r.o. 1844.25



**2933**  
capuchón amortiguador delantero  
r.o. 5254.18



**2935**      **reversible**  
soporte amortiguador delantero **dcho e izqd.**  
r.o. 5038.24-5038.23-5038.21



**2975**  
tope poliuretano suspensión delantera  
r.o. 5033.27

PEUGEOT - 306

 <p><b>2977</b> soporte brazo trasero derecho r.o.5131.70-5131.A3</p>	 <p><b>2978</b> soporte brazo trasero izquierdo r.o.5131.69-5131.A2</p>	 <p><b>2980</b> silentbloc soporte posterior motor 2.0 HDi r.o.1809.21</p>
 <p><b>4053</b> bieleta puntal barra estabilizadora delantera r.o.5087.42</p>	 <p><b>4064</b> silentbloc soporte posterior motor 1.4 r.o. no hay despiece</p>	 <p><b>4181</b> rodamiento soporte amortiguador delt. r.o.5035.27</p>
<p><i>¡Nuevo!</i></p>  <p><b>4413</b> jgo. reparación brazo trasero completo con rodamientos, r.o.5132.49+5132.45</p>	<p><i>¡Nuevo!</i></p>  <p><b>4550</b> eje brazo trasero (derecho e izquierdo) r.o.</p>	<p><i>¡Nuevo!</i></p>  <p><b>4743</b> tirante posterior motor completo 1.4TU-1.6TU, r.o..</p>
<p><i>¡Nuevo!</i></p>  <p><b>4745</b> tirante posterior motor completo 1.8-1.9D-1.9TD-1.9DW8-2.0HDi, r.o.</p>	<p><i>¡Nuevo!</i></p>  <p><b>4828</b> juego retén eje trasero y tapón tambor r.o.3724.24+3740.19</p>	 <p><b>90013</b> buje rueda delantera 1.4 sin ABS r.o.</p>
 <p><b>90012</b> buje rueda delantera 1.4 con ABS -1.6-1.8-1.9-Diesel-TurboDyHDi, r.o.3307.72</p>	 <p><b>96099</b> latiguillo freno delantero (535 mm) r.o.4806.26</p>	 <p><b>96031</b> latiguillo freno trasero (265 mm) r.o.4806.64-4806.65</p>

ARTICULACIONES PALANCA DE CAMBIO

motores 1.4-1.6 TU:  
cambio MA

motores 1.8 - 1.9 D/TD-DW - 2.0 - 1.8/16 v y 2.0HDi.:  
cambio BE3R

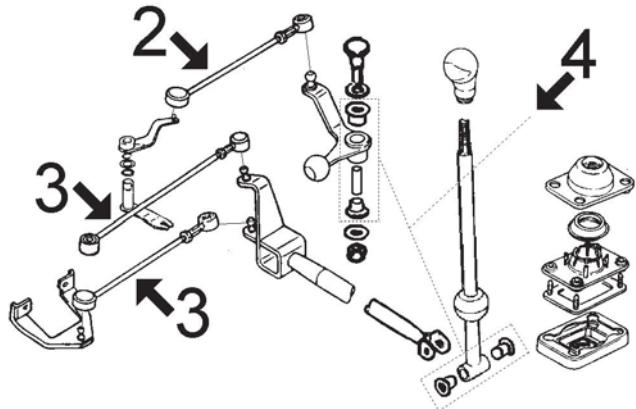
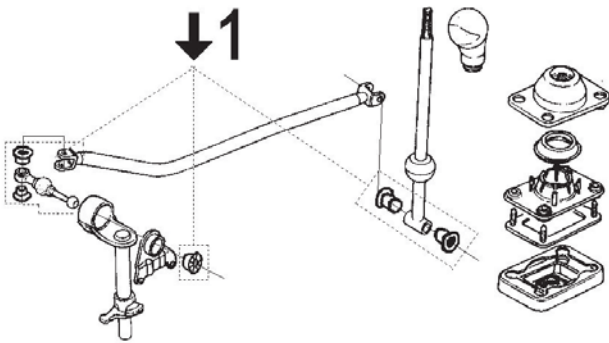

- 1- 4993 articulación completa con casquillos cambio MA hasta -'97
- 4990 articulación completa con casquillos cambio MA desde '97-
- 2- 2866 bieleta selector velocidades

- 3- 2865 bieleta selector velocidades
- 4- 4992 articulación completa con casquillos cambio BE3R

**¡Nuevo!**

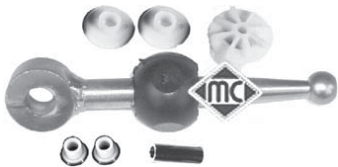

**4993**  
articulación reenvío cambio completa con casquillos 1-4-1.6 TU hasta -'97 (cambio MA)

long. máx: 135 mm  
long. mín: 86 mm



**2865**  
bieleta selector velocidades  
(rótula de Ø 10 mm), r.o. 2454.E6

**¡Nuevo!**



**4990**  
articulación reenvío cambio completa con casquillos 1-4-1.6 TU d/'97- (cambio MA)

long. máx. 400 mm  
long. mín. 300 mm



**2866**  
bieleta selector velocidades  
(rótulas de Ø 13 mm), r.o. 2452.75

**¡Nuevo!**



















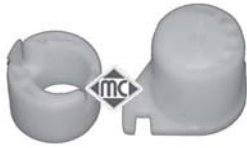

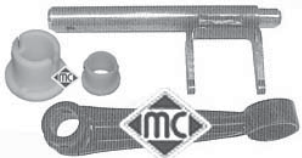

**4992**  
articulación reenvío cambio completa con casquillos cambio BE3R (motores XU-DW)



**2335**  
varilla nivel aceite 1.4 - 1.6  
r.o. 1174.10



PEUGEOT - 306

<p><b>¡Nuevo!</b></p>  <p><b>4612</b> varilla nivel aceite 1.9D-TD r.o. 1174.15</p>	<p><b>¡Nuevo!</b></p>  <p><b>4593</b> varilla nivel aceite 1.4TU r.o. 1174.82-1174.44</p>	<p><b>¡Nuevo!</b></p>  <p><b>4597</b> varilla nivel aceite 1.9DW8 r.o. 1174.46</p>
<p><b>¡Nuevo!</b></p>  <p><b>4594</b> varilla nivel aceite 2.0HDi r.o.</p>	<p><b>¡Nuevo!</b></p>  <p><b>4424</b> casquillo guía embrague cambio MA (motores TU), r.o. 2105.14</p>	<p><b>¡Nuevo!</b></p>  <p><b>4605</b> casquillo guía embrague cambio BE3/BE4 (motores XU y DW), r.o. 2105.35</p>
 <p><b>4043</b> juego casquillos horquilla embrague motor res XU y DW, r.o. 2175.20-2175.21</p>	 <p><b>4052</b> horquilla embrague completa 1.8-1.9-2.0 y D con casquillos, r.o. 2115.25</p>	 <p><b>4057</b> juego casquillos horquilla embrague 1.4-1.6 r.o. 2175.11-2175.12</p>
 <p><b>4300</b> horquilla embrague completa 1.4-1.6 con casquillos, r.o. 2117.52</p>	 <p><b>4051</b> juego casquillos horquilla embrague motor XU y DW desde PR-8485, r.o. 2175.54/55</p>	 <p><b>2434</b> bioleta sujeción cable embrague r.o. 2128.21+2138.05</p>
<p><b>¡Nuevo!</b></p>  <p><b>3639</b> tapón llenado aceite 1.4TU r.o. 0258.55</p>	<p><b>¡Nuevo!</b></p>  <p><b>3642</b> tapón llenado aceite 1.9DW8 y 2.0HDi r.o. 1180.F9</p>	<p><b>¡Nuevo!</b></p>  <p><b>3651</b> tapa filtro gasoil 1.9DW8 con junta y clip de cierre, r.o. 1904.27+1904.26</p>
 <p><b>2926</b> polea cigueñal 1.9 Diesel y TurboD hasta '98 (motores XUD), r.o. 0515.G3</p>	 <p><b>2927</b> polea cigueñal 1.9 Diesel desde '98 (motor DW8), r.o. 0515.Q6</p>	 <p><b>2928</b> polea cigueñal 1.9DW8 y 2.0 HDi r.o. 0515.P2</p>
<p><b>¡Nuevo!</b></p>  <p><b>4485</b> polea cigueñal 1.8/8v. r.o. 0515.H6</p>	<p><b>¡Nuevo!</b></p>  <p><b>4481</b> polea cigueñal 1.8/16v y 2.0/16v. r.o. 0515.K6</p>	 <p><b>2931</b> tensor correa alternador completo r.o. 5751.81</p>

PEUGEOT - 306



**1648**  
fuelle derecho cremallera manual desde '97  
r.o. 4066.44



**1740**  
fuelle izquierdo cremallera manual desde '97  
r.o. 4066.43



**287**  
juego casquillos cremallera manual  
r.o.

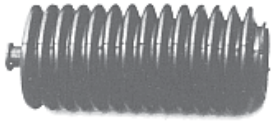

**1268 kit**                      **268 fuelle**  
fuelle cremallera dirección, dcho+izqd  
manual, izqdo. asistida, hasta '97, r.o.



**1845**  
fuelle derecho cremallera asistida  
r.o. 4066.28



**844**  
capuchón derecho cremallera asitida  
r.o. 4066.16



**2306**  
silentbloc pistón cremallera asistida  
r.o. 4059.06 (12x22x20x24)



**1521**  
kit rep. transmisión l/rueda 1.4(sin ABS)-1.6  
r.o.



**1533**  
kit rep. transmisión l/cambio 1.4-1.6  
r.o. 3287.74 - 3287.69



**1222**  
kit rep. transmisión l/rueda 1.8-2.0-D-TD  
r.o. 3293.03



**1213**  
kit rep. transmisión l/cambio 1.8-2.0-D-TD  
r.o. 3287.81



**1427**  
kit rep. transmisión l/rueda 1.4-1.6 desde '98  
r.o.



**1432**  
kit rep. transmisión l/rueda 1.4 con ABS hasta '98, r.o.



**1428**  
kit rep. transmisión l/cbo 1.4-1.6 desde '98  
r.o.



**4564**                      Ø 30/47 y 40/58 mm  
juego retenes diferencial-distribución  
r.o. 3121.46+3121.44



**4826**  
tensor correa alternador 1.9D-TD desde 6/'95  
r.o. 5751.30



**4609**  
tensor correa alternador 1.9D hasta 6/'95  
r.o. 5751.38

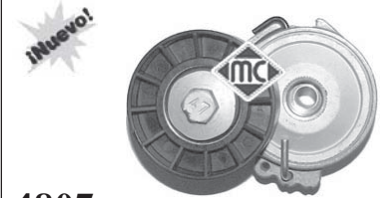

**4807**  
tensor correa alternador 2.0HDi  
r.o. 5751.55



**3697**  
juego tapas correa distribución 1.4TU  
r.o. 0320.S2+0320.L3





















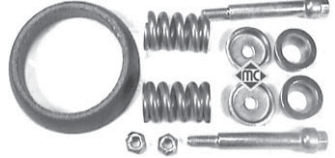

**3698**  
juego tapas correa distribución 1.9D-TD  
r.o. 0320.H2+0320.H3+0320.F9



**3699**  
juego tapas correa distribución 2.0HDi  
r.o. 0320.N5+0320.N6+0320.S7

PEUGEOT - 306

<p><b>¡Nuevo!</b></p>  <p><b>4928</b> Ø 10-60 / 25 mm rodillo tensor correa alternador XUD-1.9DW sin A/C, r.o. 5751.73</p>	<p><b>¡Nuevo!</b></p>  <p><b>4995</b> rodillo tensor correa alternador 1.9DW8 y 2.0HDI con A/C, r.o. 5751.29</p>	<p><b>¡Nuevo!</b></p>  <p><b>4996</b> rodillo tensor correa alternador 2.0HDI sin A/C, r.o. 5751.96-5751.57</p>
<p><b>¡Nuevo!</b></p>  <p><b>4929</b> Ø 17-90 / 25 mm rodillo tensor correa alternador 1.8-2.0 r.o. 5751.20</p>	<p><b>¡Nuevo!</b></p>  <p><b>4895</b> tensor correa alternador 1.8-2.0 r.o. 5751.35</p>	<p><b>¡Nuevo!</b></p>  <p><b>4479</b> juego soportes tapa motor 2.0HDI r.o. 0137.11+0137.23</p>
<p><b>¡Nuevo!</b></p>  <p><b>4915</b> Ø 54,60 mm polea de alternador de rueda libre r.o.</p>	<p><b>¡Nuevo!</b></p>  <p><b>4916</b> Ø 58,50 mm polea de alternador de rueda libre r.o.</p>	 <p><b>4036</b> bomba manual cebado gasoil con válvula antirretorno y boquilla adicional a 90°</p>
 <p><b>2940</b> junta de Ø 80 x 66 mm kit montaje colector 1.8-2.0 gasolina r.o.</p>	 <p><b>2938</b> junta de Ø 58 x 45 mm kit montaje colector 1.9 Diesel desde '98 (motor DW8), r.o.</p>	 <p><b>2939</b> junta de Ø 74 x 58 mm kit montaje colector 2.0 HDi r.o.</p>
 <p><b>4039</b> junta de Ø 71 x 58 mm kit montaje colector 1.6 r.o.</p>	 <p><b>4040</b> junta de Ø 71x 58 mm kit montaje colector 1.9 TurboD hasta '98 r.o.</p>	 <p><b>748</b> Ø 66 mm      <b>749</b> Ø 69 mm collarín empalme tubo de escape r.o.</p>
 <p><b>084</b> soporte tubo de escape r.o. 1755.59</p>	 <p><b>088</b> soporte tubo de escape r.o. 1755.61</p>	 <p><b>2692</b> soporte tubo de escape r.o. 1798.58</p>
 <p><b>2771</b> cubrepedal embrague r.o. 2130.13</p>	 <p><b>2770</b> cubrepedal acelerador r.o. 4504.12</p>	 <p><b>2772</b> cubrepedal acelerador r.o. 1604.07</p>

## PEUGEOT - 306



**2452**

tapón cárter 14x125  
r.o.0311.25



**2929**

tapón cárter 10x125 1.9 Diesel motor DW8  
r.o.0311.29



**2024**

junta tapón cárter con retén (Ø 14 mm)  
r.o.



**2050**

arandela metaloplástica 14x22 (para HDi)  
r.o.0313.27



**2051**

arandela plana 10x21 para tapón MC-2929  
r.o.0313.33



**016**

tapón cierre inyectores Diesel  
r.o.



**CANALIZACIONES DE AGUA:**

**mgtos. motores gasolina 1.4-TU3 y 1.6-TU5J4**

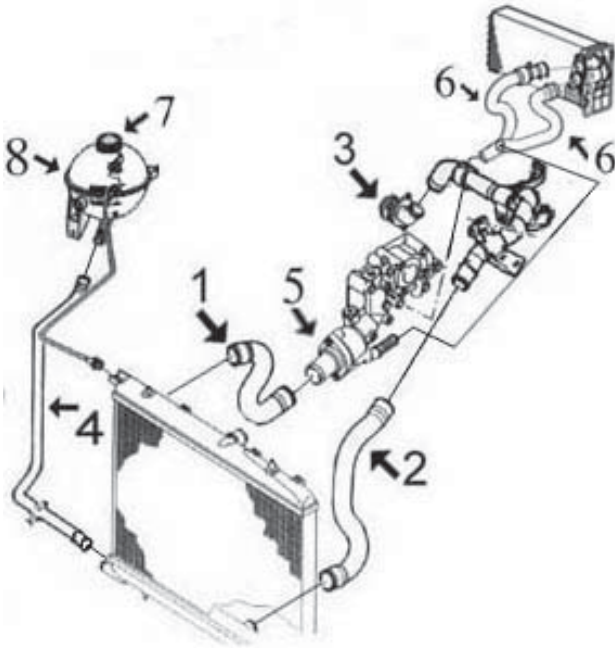

- 1- 8900 mgtos superior radiador
- 2- 8624 mgtos inferior radiador
- 3- 3641 tapa plástico bomba de agua 1.4TU3  
3640 tapa plástico bomba de agua 1.6TU5
- 4- n/d mgtos de botella a radiador
- 5- 3620 tapa con termostato
- 6- 8938 juego mgtos entrada/salida calefactor
- 7- 3560 tapón botella de expansión
- 8- 3638 botella de expansión

**mgtos. motor gasolina 2.0-EW10J4**

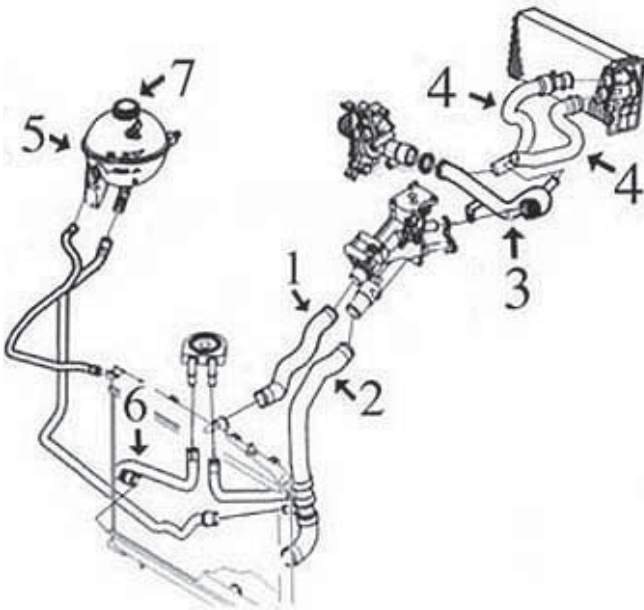

- 1- 8940 mgtos superior radiador
- 2- 8945 mgtos inferior radiador
- 3- n/d tubo de conexión de plástico
- 4- 8942 juego mgtos entrada/salida calefactor
- 5- 3638 botella de expansión
- 6- 8944 mgtos de intercambiador a radiador
- 7- 3560 tapón botella de expansión

mgts. motores Diesel 2.0HDi-DW10TD (90CV) y DW10ATED (110CV)

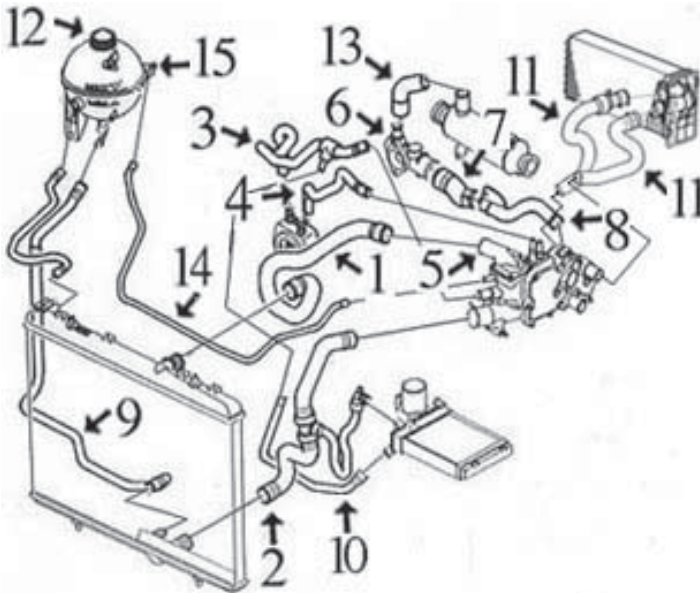

- 1- 8899 mgto superior radiador TD-90CV
- 8935 mgto superior radiador ATED-110CV o con FAP(\*)
- 2- 8896 mgto inferior radiador TD-90CV
- 8934 mgto inferior radiador ATED-110CV o con FAP(\*)
- 3- 8554 mgto de intercambiador a caja de termostato hasta 09170 (-1/'02)
- 8943 juego de mgts de intercambiador a caja de termostato desde 09170 (-1/'02)
- 4- 8586 mgto de intercambiador a caja de termostato hasta 09170 (-1/'02)
- 8943 juego de mgts de intercambiador a caja de termostato desde 09170 (-1/'02)
- 5- 3556 tapa de termostato
- 6- 3554 brida posterior de conexiones (plástico)
- 7- 8587 mgto de brida conexiones a tubo metálico
- 8- 3139 tubo metálico
- 9- 8937 mgto de botella a radiador
- 10- n/d no es de aplicación en este modelo
- 11- 8936 juego de manguitos entrada/salida calefactor
- 12- 3560 tapón botella de expansión
- 13- 8668 mgto de brida conexión a filtro de partículas (FAP)
- 14- n/d mgto de botella a caja de termostato
- 15- 3638 botella de expansión



8636 mgto desvaporizador 2.0HDi

(\*) FAP=filtro de partículas



**8554**  
mgto de intercambiador a caja de termostato 2.0HDi, r.o. 1307.RR



**8586**  
mgto de intercambiador a caja de termostato 2.0HDi, r.o. 1307.RZ



**8587**  
mgto de brida plástico a tubo metálico 2.0HDi, r.o. 1307.PR



**8624**  
mgto inferior radiador 1.4TU3-1.6TU5 r.o. 1351.Y4



**8668**  
mgto de brida plástico a filtro de partículas 2.0HDi, r.o. 1307.RS

**¡Nuevo!**



**8896**  
mgto inf radiador 2.0HDi-90cv r.o.

**¡Nuevo!**



**8899**  
mgto sup radiador 2.0HDi-90cv r.o.

**¡Nuevo!**





















**8900**  
mgto sup radiador 1.4TU3-1.6TU5 r.o.

**¡Nuevo!**



**8934**  
mgto inf radiador 2.0HDi-110cv ó FAP r.o.

PEUGEOT - 307

<p><b>¡Nuevo!</b></p>  <p><b>8935</b> mgto sup radiador 2.0HDi-110cv ó FAP r.o.</p>	<p><b>¡Nuevo!</b></p>  <p><b>8936</b> juego mgto calefactor 2.0HDi r.o.</p>	<p><b>¡Nuevo!</b></p>  <p><b>8937</b> mgto de botella a radiador 2.0HDi r.o.</p>
<p><b>¡Nuevo!</b></p>  <p><b>8938</b> jgo mgto calefactor 1.4TU3-1.6TU5 r.o.</p>	<p><b>¡Nuevo!</b></p>  <p><b>8940</b> mgto sup radiador 2.0EW10 gasolina r.o.</p>	<p><b>¡Nuevo!</b></p>  <p><b>8942</b> jgo mgto calefactor 2.0EW10 r.o.</p>
<p><b>¡Nuevo!</b></p>  <p><b>8943</b> jgo mgto intercambiador 2.0HDi desde '02- r.o.</p>	<p><b>¡Nuevo!</b></p>  <p><b>8944</b> mgto de intercambiador a radiador 2.0EW10 r.o.</p>	<p><b>¡Nuevo!</b></p>  <p><b>8945</b> mgto inf radiador 2.0EW10 gasolina r.o.</p>
 <p><b>3139</b> tubo de agua metálico 2.0HDi r.o. 1307.YZ</p>	 <p><b>3554</b> brida plástico conexión mgto 2.0HDi r.o. 1336.P5</p>	 <p><b>3556</b> tapa de termostato 2.0HDi r.o. 1336.R9</p>
 <p><b>3560</b> tapón botella de expansión r.o. 1306.E4</p>	 <p><b>3620</b> tapa con termostato 1.4TU3-1.6TU5 r.o. 1336.Q1</p>	<p><b>¡Nuevo!</b></p>  <p><b>3638</b> botella de expansión (con juego de conec- tores), r.o. 1307.VE-1323.27</p>
<p><b>¡Nuevo!</b></p>  <p><b>3640</b> tapa en bomba de agua 1.4TU3 con junta r.o. 1201.C3+1206.98</p>	<p><b>¡Nuevo!</b></p>  <p><b>3641</b> tapa en bomba de agua 1.6TU5 con junta r.o. 1201.C2+1206.96</p>	
<p></p>  <p><b>8636</b> mgto desvaporizador 2.0HDi r.o.</p>		

**SUSPENSION DELANTERA y SOPORTES de MOTOR todos modelos:**

1.4 TU3  
 1.4-16v ET3J4  
 1.6 TU5J4  
 2.0 EW10 gasolina  
 1.4 DV4 HDi  
 1.6 DV6 HDi  
 2.0 DW10TD HDi 8v de 90cv  
 2.0 DW10ATED HDi 8v de 110cv  
 2.0 DW10BTED HDi-16v

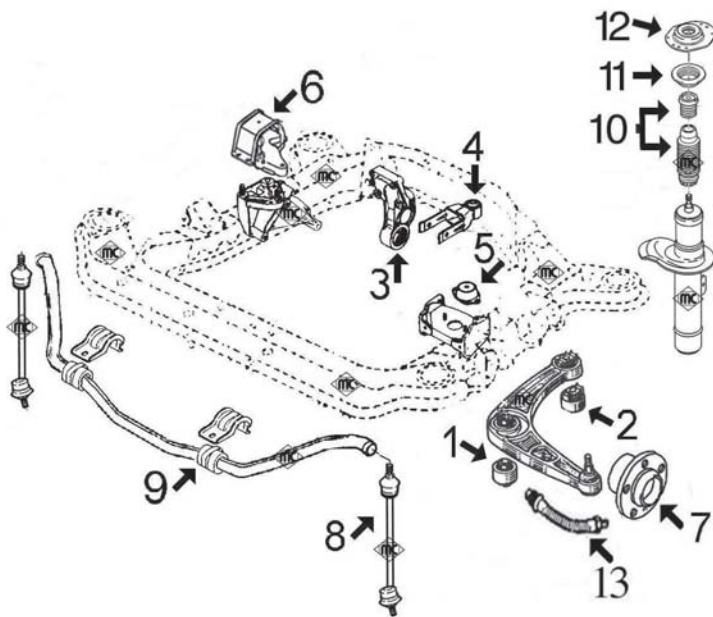

- 1- 4444 silentbloc anterior trapecio delantero
- 2- 4034 silentbloc posterior trapecio delantero
- 3- 4064 silentbloc soporte posterior motor 1.4TU3,  
1.4-16vET3J4 y 1.6-16vTU5J4
- 2980 silentbloc soporte posterior motor 2.0EW10,  
1.4HDi y 2.0HDi (90cv)
- 4428 silentbloc soporte posterior motor 1.6HDi y  
2.0HDi-110cv
- 4- 4733 tirante posterior motor completo
- 2871 silentbloc en tirante posterior motor
- 5- 2786 soporte motor izquierdo 1.4-1.6-1.4HDi-1.6HDi
- 2794 soporte motor izquierdo 2.0EW10-2.0HDi
- 6- 4432 soporte motor dcho. 1.4 TU3
- 4742 soporte motor dcho. 1.4/16v (ET3J4)
- 4432 soporte motor dcho. 1.6/16v TU5J4 (cambio MA)
- 4437 soporte motor dcho 1.6/16v TU5J4 (cambio BE4R)  
y automáticos
- 4435 soporte motor derecho 2.0 gasolina EW10
- 4436 soporte motor derecho 1.4 HDi
- 4732 soporte motor derecho 1.6 HDi
- 4433 soporte motor derecho 2.0 HDi-90cv (8v)
- 4434 soporte motor derecho 2.0 HDi-110cv (8v)
- 4763 soporte motor derecho 2.0 HDi/16v (DW10BTED4)
- 7- 90012 buje rueda delantera (25 estrías)
- 8- 4401 bieleta puntal barra estabilizadora
- 9- 4431 goma barra estabilizadora
- 10- 4604 jgo. capuchón amortiguador con tope de poliuretano
- 11- 4181 rodamiento soporte amortiguador
- 12- 4427 soporte amortiguador
- 13- 96162 latiguillo freno delantero (445 mm)

**SUSPENSION TRASERA todos modelos:**

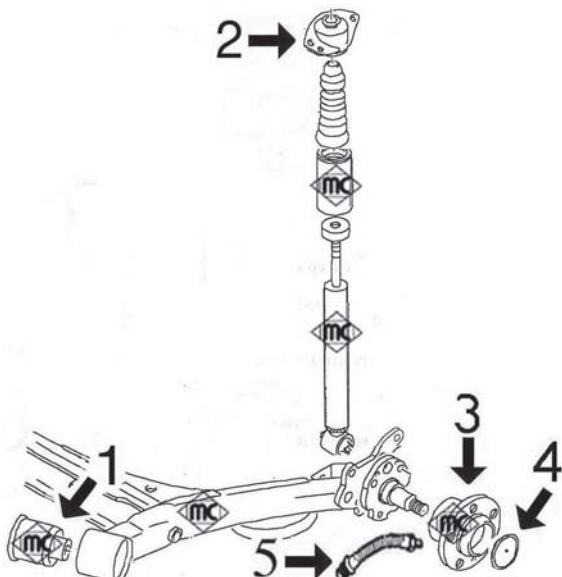

- 1- 4429 silentbloc brazo trasero
- 2- 4430 soporte amortiguador trasero
- 3- n/d buje con rodamiento
- 4- n/d tapón buje trasero
- 5- 96163 latiguillo freno trasero (210 mm)



PEUGEOT - 307



**2786**

soporte motor izquierdo 1.4TU3-1.6TU5-1.4HDi y 1.6HDi, r.o. 1844.51



**2794**

soporte motor izquierdo 2.0EW10 y 2.0HDi r.o. 1827.10-1844.36



**2871**

silentbloc en tirante posterior motor r.o. 1809.22



**2980**

silentbloc en soporte motor trasero 2.0EW10, 2.0HDi(90cv), 1.4HDi y 1.6HDi, r.o. 1809.16



**4034**

silentbloc posterior trapecio delantero r.o. 3523.77-3523.92



**4064**

silentbloc en soporte motor trasero 1.4TU3 y 1.6TU5, r.o.



**4181**

rodamiento soporte amortiguador delantero r.o. 5035.27



**4401**

bieleta puntal barra estabilizadora delantera r.o. 5087.50

**¡Nuevo!**



**4427**

soporte amortiguador delantero r.o. 5038.85-5038.46

**¡Nuevo!**



**4428**

silentbloc en soporte motor trasero 2.0HDi de 110cv y 1.6HDi, r.o. 1809.33-1809.35

**¡Nuevo!**



**4429**

silentbloc brazo trasero suspensión r.o. 5131.A4

**¡Nuevo!**



**4430**

soporte amortiguador trasero r.o. 5142.30-5142.32

**¡Nuevo!**



**4431**

goma soporte barra estabilizadora r.o. 5094.87

**¡Nuevo!**



**4432**

soporte motor dcho. 1.4TU3-1.6/16v (cambio MA), r.o.

**¡Nuevo!**

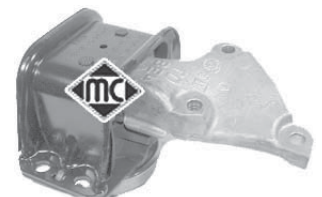

**4433**

soporte motor dcho. 2.0HDi-90cv (8v) r.o.

**¡Nuevo!**



**4434**

soporte motor dcho. 2.0HDi-110cv (8v) r.o.

**¡Nuevo!**



**4435**

soporte motor dcho. 2.0 gasolina EW10 r.o.

**¡Nuevo!**



**4436**

soporte motor dcho. 1.4HDi-1.6HDi r.o.

**¡Nuevo!**



**4437**

soporte motor dcho. 1.6/16v TU5J4 (cambio BE4R) y automáticos, r.o.

**¡Nuevo!**



**4444**

silentbloc anterior trapecio delantero r.o. 3523.91







**¡Nuevo!**







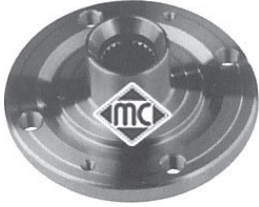













**4604**

jgo capuchón y tope poliuretano amortiguador delantero, r.o. 5254.31+5033.70

PEUGEOT - 307

<p><b>iNuevo!</b></p>  <p><b>4732</b> soporte motor dcho. 1.6 HDi r.o.</p>	<p><b>iNuevo!</b></p>  <p><b>4733</b> tirante motor trasero completo r.o.</p>	<p><b>iNuevo!</b></p>  <p><b>4742</b> soporte motor dcho. 1.4-16v (motor ET3J4) r.o.</p>
<p><b>iNuevo!</b></p>  <p><b>4763</b> soporte motor dcho. 2.0HDi-16v (motor DW10BTED4), r.o.</p>	 <p><b>90012</b> buje rueda delantera r.o. 3307.72</p>	<p><b>iNuevo!</b></p>  <p><b>96162</b> latiguillo freno delantero (445 mm) r.o. 4806.A0</p>
<p><b>iNuevo!</b></p>  <p><b>96163</b> latiguillo freno trasero (210 mm) r.o. 4806.A1</p>		

PEUGEOT - 307

<p><b>iNuevo!</b></p>  <p><b>4600</b> horquilla embrague 1.4TU3 - 1.6TU5 r.o.</p>	<p><b>iNuevo!</b></p>  <p><b>4601</b> horquilla embrague 1.4HDi-1.6HDi-2.0HDi y 2.0 gasolina EW10, r.o.</p>	<p><b>iNuevo!</b></p>  <p><b>4796</b> casquillo guía embrague (cambio MA) r.o.2105.38</p>
<p><b>iNuevo!</b></p>  <p><b>4605</b> casquillo guía embrague (cambio BE4R) r.o.2105.35</p>	<p><b>iNuevo!</b></p>  <p><b>4564</b>      <math>\text{Ø } 30/47 \text{ y } 40/58 \text{ mm}</math> jgo. retenes transmisión (salvo cambio de 6 velocidades), r.o. 3121.44+3121.46</p>	<p><b>iNuevo!</b></p>  <p><b>4620</b>      <math>\text{Ø } 32/50 \text{ y } 40/58 \text{ mm}</math> jgo. retenes transmisión (cambio CVM M6 de 6 velocidades), r.o. 3121.44+3121.24</p>
<p><b>iNuevo!</b></p>  <p><b>4602</b> bieleta cambio velocidades todos mods. r.o.</p>	<p><b>1427</b></p>  <p>kit rep. transmisión l/rda. 1.1-1.4-1.6-1.4HDi r.o.3293.20</p>	<p><b>1428</b></p>  <p>kit rep. transmisión l/cbo. 1.1-1.4-1.6 r.o.3287.88</p>
<p><b>1222</b></p>  <p>kit fuelle transmisión l/rda. 1.4HDi-1.6/16v y 2.0HDi-2.0/16v hasta 2/'01, r.o. 3293.03</p>	<p><b>1213</b></p>  <p>kit fuelle transmisión l/cbo. 2.0HDi/8v y 2.0/16v, r.o.3287.81</p>	<p><b>1460</b></p>  <p>kit fuelle transmisión l/rda. 2.0HDi/16v r.o.3293.02</p>
<p><b>iNuevo!</b></p>  <p><b>1113</b> kit fuelle transmisión l/rda. 2.0HDi-2.0EW desde 2/'01, r.o. 3293.31</p>	<p><b>iNuevo!</b></p>  <p><b>1110</b> kit fuelle transmisión l/cbo 2.0HDi/16v r.o.3287.A4-3287.96</p>	<p><b>1480</b></p>  <p>fuelle cremallera dirección r.o.4066.57</p>
<p><b>iNuevo!</b></p>  <p><b>4442</b> polea cigueñal 1.4 TU3-1.6TU5 <math>\text{Ø } 146 \text{ mm}</math> r.o.</p>	<p><b>iNuevo!</b></p>  <p><b>4569</b> polea cigueñal 1.4 TU3-1.6TU5 <math>\text{Ø } 152 \text{ mm}</math> r.o.</p>	<p><b>iNuevo!</b></p>  <p><b>4440</b> polea cigueñal 1.4-16v ET3J4 r.o.0515.R8</p>
<p><b>iNuevo!</b></p>  <p><b>4443</b> polea cigueñal 2.0 gasolina '03 r.o.</p>	<p><b>iNuevo!</b></p>  <p><b>4562</b> polea cigueñal 2.0 gasolina '03- r.o.</p>	<p><b>iNuevo!</b></p>  <p><b>4441</b> polea cigueñal 1.4HDi - 1.6HDi r.o.0515.P8</p>



PEUGEOT - 307



**2928**  
polea cigüeñal 2.0 HDi -'03  
r.o. 0515.P2



**4477**  
polea cigüeñal 2.0 HDi '03-  
r.o. 0515.s4



**4738**  
polea cigüeñal 2.0 HDi-16v (DW10BTED4)  
r.o. 0515.



**3639**  
tapón llenado aceite 1.4 TU3  
r.o.



**3659**  
tapón llenado aceite 1.6 TU5 y 2.0 gasolina  
r.o.



**3642**  
tapón llenado aceite 1.4 HDi-1.6 HDi-2.0 HDi  
r.o.



**4593**  
varilla nivel aceite 1.4 TU3  
r.o.



**4739**  
varilla nivel aceite 1.6/16v TU5JP4  
r.o.



**4740**  
varilla nivel aceite 1.4 HDi  
r.o.



**4741**  
varilla nivel aceite 1.6 HDi  
r.o.



**4594**  
varilla nivel aceite 2.0 HDi (8v)  
r.o.



**4479**  
jgo soportes tapa motor HDi  
r.o. 0137.11+0137.23

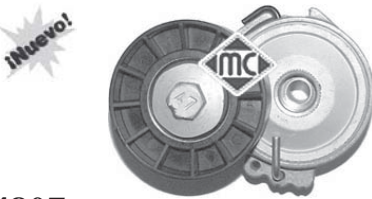

**4807** rodillo de Ø 70 mm  
tensor correa alternador 2.0 HDi  
r.o. 5751.55

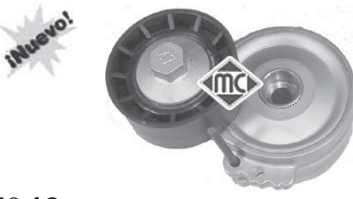

**5043** rodillo de Ø 60 mm  
tensor correa alternador 2.0 HDi  
r.o. 5751.74



**4996**  
rodillo tensor correa alternador 2.0 HDi sin  
A/C, r.o. 5751.96-5751.57



**3697**  
juego tapas correa distribución 1.4 TU  
r.o. 0320.S2+0320.L3



**3699**  
juego tapas correa distribución 2.0 HDi  
r.o. 0320.N5+0320.N6+0320.S7



**4915** Ø 54,60 mm  
polea de alternador de rueda libre  
r.o.



**4916** Ø 58,50 mm  
polea de alternador de rueda libre  
r.o.



**4036**  
bomba manual cebado gasoil con válvula  
antirretorno y boquilla adicional a 90°



PEUGEOT - 307



**4065** junta de Ø 58 x 46 mm  
kit montaje colector escape 1.4TU3-1.6TU5  
r.o.

**¡Nuevo!**



**4925** soporte escape anterior (silicona)  
r.o. 1755.E6-1755.94

**¡Nuevo!**



**4425** soporte escape intermedio  
r.o. 1755.C8

**¡Nuevo!**



**4422** soporte escape posterior izquierdo  
r.o. 1755.C6

**¡Nuevo!**



**4423** soporte escape posterior derecho Break  
r.o. 1755.E2

**¡Nuevo!**



**4426** soporte escape posterior derecho berlina  
r.o. 1755.C4



**0667** M-16x150  
tapón cárter de aceite motor 1.4-1.6 gasolina  
r.o. 0163.93



**2452** M-14x125  
tapón cárter de aceite 2.0-16v - 2.0HDi con  
aire acond., r.o. 0311.21



**2929** M-10x125  
tapón cárter de aceite 1.4HDi-1.6HDi y  
2.0HDi sin aire acond., r.o. 0311.29



**2050** Ø 14 x 22 mm  
arandela metaloplástica para tapón de cárter  
de Ø 14 mm, r.o. 0313.27



**2051**  
arandela plana para tapón cárter de Ø 14  
mm, r.o. 0313.33

CANALIZACIONES DE AGUA

405 1580 cc (motores XU52C de carburador -hasta '91- y XU5M de inyección de '91 a '95)  
 405 1905 cc -CARBURADOR (motor XU92C -hasta '91-)

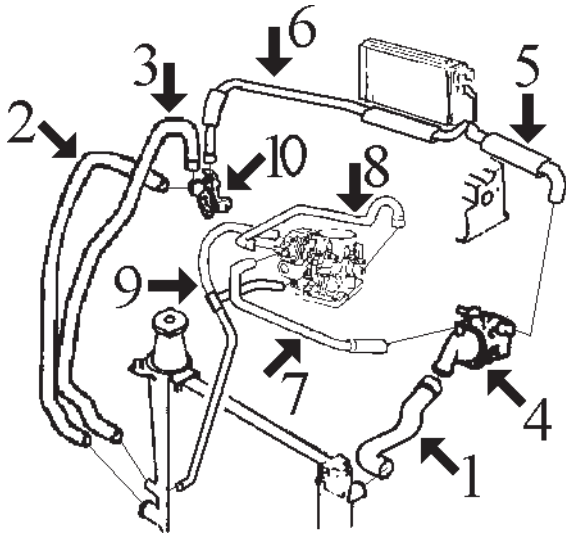

- 1- 7899 mgto superior radiador hasta '91  
8376 mgto superior rad. desde '91 (enchufe rápido)
- 2- 7900 mgto inferior radiador hasta '91  
8372 mgto inferior rad. desde '91 (enchufe rápido)
- 3- 8000 mgto de radiador a racor entrada agua Ø 36 hasta '91  
8373 mgto de radiador a racor entrada agua desde '91 (enchufe rápido)
- 4- 3551 tapa de termostato (Ø base 56 mm)  
3552 tapa de termostato (Ø base 53 mm)  
2351 junta de termostato desde mod. '91
- 5- 8163 mgto de calefactor a caja de termostato
- 6- 8162 mgto de calefactor a racor entrada agua
- 7- 117 mgto de carburador a caja de termostato: Cortar de rollo MC-117 Ø 10x17 long. 27 cms.
- 8- n/d mgto a stárter
- 9- n/d mgto de carburador a radiador y a colector de admisión (3 vias)
- 10- 3523 racor entrada agua conexión mgtos.

405 1905 cc INYECCION (SRI, motor XU9J2 hasta '93)

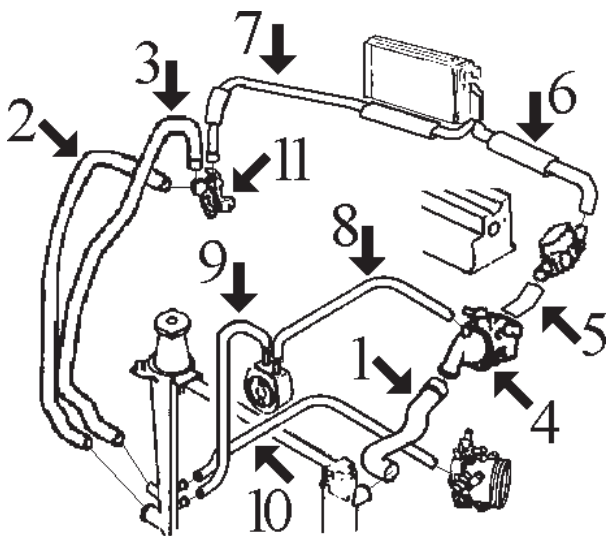

- 1- 7901 mgto superior radiador SRI hasta '91  
8376 mgto superior radiador SRI desde '91 (enchufe rápido)
- 2- 7900 mgto inferior radiador hasta '91  
8372 mgto inferior rad. desde '91 (enchufe rápido)
- 3- 8000 mgto de radiador a racor entrada agua hasta '91  
8373 mgto de radiador a racor entrada agua desde '91 (enchufe rápido)
- 4- 3551 tapa de termostato (Ø base 56 mm)  
3552 tapa de termostato (Ø base 53 mm)  
2351 junta de termostato desde mod. '91
- 5- 8186 mgto de caja termostato a caja agua stárter SRI
- 6- 8163 mgto de calefactor a caja agua stárter hasta '91  
8439 mgto de calefactor a caja termostato desde '91
- 7- 8162 mgto de calefactor a racor entrada agua
- 8- 8062 mgto de intercambiador a caja termostato
- 9- 7839 mgto de radiador a intercambiador
- 10- 8080 mgto de radiador a caja de mariposa hasta '91  
8548 mgto de radiador a caja termostato desde '91
- 11- 3523 racor de agua conexión mgtos.

## PEUGEOT 405

405 1.8 (motor XU7JP de 1761 cc de inyección desde '93 hasta '95)  
405 2.0 (motor XU10J2 de 1998 cc de inyección desde '93 hasta '95)

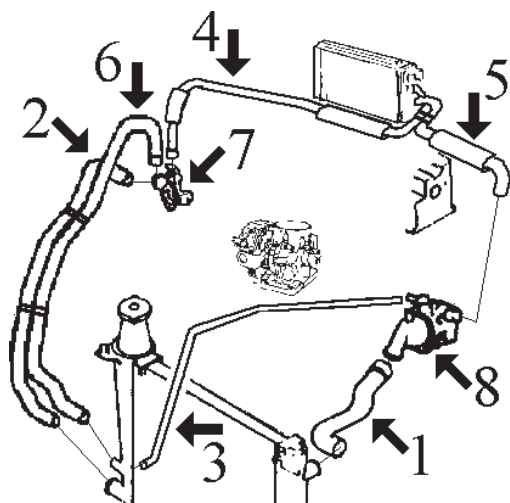

- 1- 8376 mgto superior radiador
  - 2- 8372 mgto inferior radiador
  - 3- 8548 mgto de radiador a caja de termostato
  - 4- 8162 mgto de calefactor a racor entrada agua
  - 5- 8439 mgto de calefactor a caja de termostato
  - 6- 8373 mgto de radiador a racor entrada agua
  - 7- 3523 racor entrada agua a bloque (salvo 2.0)
  - 8- 3538 tapa de termostato
- 2351 junta de termostato Ø 41x47  
3077 boquilla metálica en caja termostato Ø 20 mm  
3078 boquilla metálica en caja termostato Ø 10 mm

405 DIESEL (motor XUD9 de 1905 cc)  
405 TURBODIESEL (motor XUD9TE)

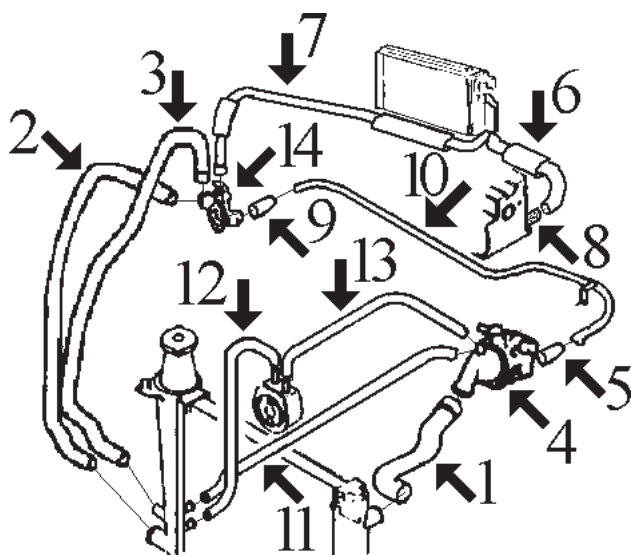

- 1- 7896 mgto superior radiador Diesel hasta '91
- 7898 mgto superior radiador TurboDiesel hasta '91
- 8375 mgto superior radiador Diesel y TurboD desde '91 (enchufe rápido)
- 2- 7897 mgto inferior radiador hasta '91
- 8551 mgto inf. rad. desde '91 hasta '93 (enchufe rápido)
- 8372 mgto inferior radiador desde '93 (enchufe rápido)
- 3- 8064 mgto de radiador a racor plástico hasta '91
- 8659 mgto de radiador a racor desde '91 hasta '93
- 8373 mgto de radiador a racor plástico desde '93
- 4- 3539 tapa de termostato desde '91
- 3171 boquilla metálica en caja de termostato
- 2361 junta de termostato desde '91
- 5- 7949 mgto de termostato a tubo metálico hasta '91
- 8183 mgto de termostato a tubo metálico desde '91
- 6- 8171 mgto de calefactor a boquilla en culata
- 7- 8162 mgto de calefactor a racor de entrada agua
- 8- 3059 boquilla en culata
- 9- 7948 mgto de tubo metálico a racor entrada hasta '91
- 8312 mgto de tubo metálico a racor entrada desde '91
- 10- 3057 tubo metálico de termostato a racor entrada
- 11- 8081 mgto de radiador a tapa termostato hasta '91
- 12- 7839 mgto de radiador a intercambiador
- 13- 8062 mgto de intercambiador a tapa de termostato
- 14- 3503 racor entrada conexión mgts

### MANGUITOS DESVAPORIZADORES

motor XU carburador e inyección

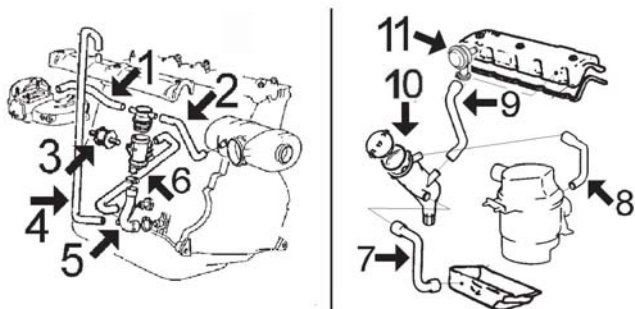

- 1- 8320 de tapón de llenado a colector (salvo 2.0)
- 2- 8305 de tapón de llenado a filtro de aire (salvo 2.0)
- 3- 4490 soporte elástico decantador
- 4- 8304 de tapa balancines a tubo del cárter hasta '93
- 8550 de tapa balancines a tubo del cárter desde '93
- 8854 mgto doble de cárter a culata 1.8i
- 5- 8187 de decantador a cárter motor (3 vías)
- 6- 8309 de decantador a cárter motor hasta '93
- 8549 de decantador a cárter motor desde '93

motor Diesel y TurboD:

- 7- 8166 de decantador a cárter motor
- 8- 8167 de decantador a filtro de aire Diesel
- 8308 de decantador a filtro de aire TurboD
- 9- 8307 de decantador a tapa de balancines
- 10- 3631 decantador completo con tapón 1.9D-TD
- 11- 3637 válvula desvaporizadora

PEUGEOT 405



**7839**  
mgto de radiador a intercambiador, inyección, Diesel y TurboD, r.o. 1307.K2



**7896**  
mgto superior radiador Diesel hasta '91 r.o. 1343.A4



**7897**  
mgto inferior radiador Diesel y TurboD hasta '91, r.o. 1351.55



**7898**  
mgto superior radiador TurboD hasta '91 r.o. 1343.C0



**7899**  
mgto superior radiador 1.6-1.9 GL-GR (motor XU carburador), r.o. 1343.A1



**7900**  
mgto inferior radiador GL-GR-SR-SRI-GRI y Mi-16 hasta '91, r.o. 1351.51



**7901**  
mgto superior radiador SRI-GRI (1.9i) hasta '91, r.o. 1343.A2 - 1343.E1



**7948**  
mgto de tubo metálico a racor entrada agua Diesel y TurboD hasta '91, r.o. 1307.J3

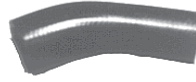

**7949**  
mgto de termostato a tubo metálico Diesel hasta '91, r.o. 1307.J4



**8000**  
mgto de radiador a racor entrada agua (gasolina hasta '91), r.o. 1351.50



**8062**  
mgto de intercambiador a termostato, inyección, Diesel y TD, r.o. 1307.J5



**8064**  
mgto de radiador a racor entrada agua (Diesel hasta '91), r.o. 1307.K3



**8080**  
mgto de radiador a caja mariposa, inyección, r.o. 1341.80 - 1351.53



**8081**  
mgto de radiador a tapa termostato D-TD hasta '91, r.o. 1307.W1 - 1307.K4



**8162**  
mgto de calefactor a racor entrada agua XU y Diesel, r.o. 6464.94 - 6464.97



**8163**  
mgto de calefactor a termostato 1.6-1.9 gasolina, r.o. 6464.95



**8166**  
mgto desvaporizador Diesel r.o. 1192.48























**8167**  
mgto desvaporizador Diesel r.o. 1192.69















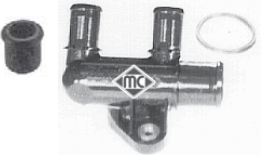

**8171**  
mgto de calefactor a culata Diesel y TD r.o. 6464.93 - 6464.P8



PEUGEOT 405

 <p><b>8183</b> mgto de termostato a tubo metálico desde '91 r.o. 1307.W3</p>	 <p><b>8186</b> mgto de termostato a caja stárter SRI-GRI r.o. 1351.04</p>	 <p><b>8187</b> mgto desvaporizador motor XU r.o. 1180.25</p>
 <p><b>8304</b> mgto desvaporizador gasolina salvo 1.8-2.0 r.o. 1180.34</p>	 <p><b>8305</b> mgto desvaporizador gasolina salvo 1.8-2.0 r.o. 1192.66</p>	 <p><b>8307</b> mgto desvaporizador Diesel y TurboD r.o. 1180.86</p>
 <p><b>8308</b> mgto desvaporizador TurboD r.o. 1180.A5</p>	 <p><b>8309</b> mgto desvaporizador gasolina salvo 1.8-2.0 r.o. 1180.34</p>	 <p><b>8312</b> mgto de tubo metálico a racor entrada Die- sel y TurboD desde '91, r.o. 1307.W4</p>
 <p><b>8372</b>                      <b>racor rápido</b> mgto inferior radiador desde '91 r.o. 1351.F3- 1351.E4</p>	 <p><b>8373</b>                      <b>racor rápido</b> mgto de radiador a racor entrada desde '91 r.o. 1351.G2- 1351.G5</p>	
 <p><b>8375</b>                      <b>racor rápido</b> mgto superior radiador Diesel y TD desde '91, r.o. 1343.H6</p>	 <p><b>8376</b>                      <b>racor rápido</b> mgto superior radiador desde '91 r.o. 1343.H8- 1343.H5</p>	 <p><b>8439</b> mgto de calefactor a caja termostato gasoli- na desde '91, r.o. 6464.P2</p>
 <p><b>8548</b> mgto de radiador a caja termostato 1.8-2.0 desde '93, r.o. 1341.64</p>	 <p><b>8549</b> mgto desvaporizador 1.8 desde '93 r.o.</p>	 <p><b>8550</b> mgto desvaporizador 1.8 desde '93 r.o.</p>
 <p><b>8551</b> mgto inferior radiador 1.9 D desde '91 a '93 r.o. 1351.A3</p>	 <p><b>8659</b> mgto de radiador a racor desde '91 a '93 r.o. 1307.R1</p>	 <p><b>8854</b> mgto desvaporizador doble 1.8i r.o. 1180.62</p>

## PEUGEOT 405

 <p><b>3057</b> tubo metálico Diesel y TurboD r.o. 1307.W2</p>	 <p><b>3059</b> boquilla en culata Diesel y TurboD r.o. 0245.42-0245.44</p>	 <p><b>3077</b> <span style="float: right;">Ø 20 mm</span> boquilla en caja termostato 1.8-2.0 r.o. 1341.63</p>
 <p><b>3171</b> boquilla en caja termostato 1.9Diesel r.o. 1336.N7</p>	 <p><b>3078</b> boquilla en caja termostato 1.8-2.0 r.o. 1336.K8</p>	 <p><b>3503</b> <span style="float: right;">con junta tórica</span> brida entrada conexión mgtos Diesel-TD r.o. 1336.G4+1340.28</p>
 <p><b>3523</b> <span style="float: right;">con junta tórica</span> brida entrada conexión mgtos gasol. XU (salvo 2.0), r.o. 1336.H7-1336.J7</p>	 <p><b>3538</b> tapa de termostato 1.8-2.0 desde '93 r.o. 1336.A1</p>	 <p><b>3539</b> tapa de termostato Diesel y TurboD desde '91, r.o. 1336.C9</p>
 <p><b>3551</b> <span style="float: right;">Ø base 56 mm</span> tapa de termostato 1.6-1.8-2.0 desde '91 hasta '93, r.o. 1336.88</p>	 <p><b>3552</b> <span style="float: right;">Ø base 53 mm</span> tapa de termostato 1.6-1.8-2.0 hasta '91 r.o. 1336.G1</p>	 <p><b>3637</b> válvula reguladora desvaporizador r.o. 0361.58</p>
 <p><b>4490</b> soporte decantador XU gasolina r.o. 1439.10</p>	 <p><b>2351</b> <span style="float: right;">Ø 41 x 47</span> junta de termostato motor XU desde '91 r.o. 1339.53</p>	 <p><b>2361</b> <span style="float: right;">Ø 51 x 58</span> junta de termostato motor Diesel d/'92 r.o. 1339.92</p>
 <p><b>3608</b> tapón de radiador hasta '91 (metálico) 1.2 bar r.o. 1306.85</p>	 <p><b>3548</b> tapón de radiador d/'91 (plástico) 1.4 bar r.o. 1306.84</p>	 <p><b>3631</b> decantador completo con tapón 1.9D-TD r.o. 1180.95</p>

SUSPENSION DELANTERA y SOPORTES DE MOTOR:

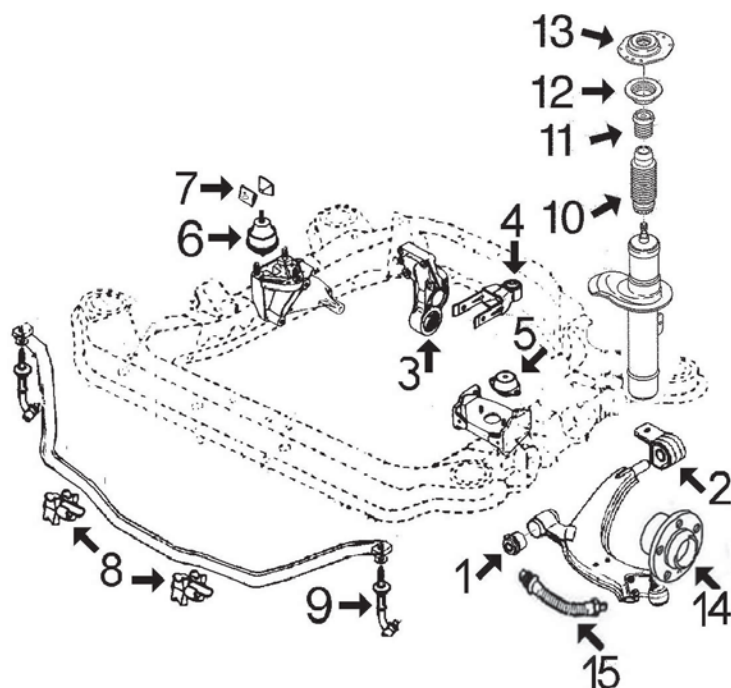

- 1- 969 silentbloc anterior trapecio delantero
- 2- 966 silentbloc posterior trapecio delantero
- 3- 2869 silentbloc de soporte de motor trasero
- 4- 4744 tirante posterior motor completo
- 877 silentbloc de tirante de motor trasero
- 5- 531 soporte de motor izquierdo todos salvo automáticos, 2.0-16v., 4x4 y TurboD
- 2794 soporte motor izquierdo TurboD desde '93
- 2943 soporte motor izquierdo automáticos, 2.0-16v. y 4x4
- 6- 697 soporte motor derecho
- 7- 2884 limitador de soporte derecho
- 8- 2436 juego 4 semicasquillos barra estabiliz. Ø 21 mm
- 2437 juego 4 semicasquillos barra estabiliz. Ø 22 mm
- 9- 2874 bieleta puntal barra estabilizadora
- 10- 2933 capuchón amortiguador delantero
- 11- 2975 tope poliuretano suspensión delantera
- 12- 4181 rodamiento soporte amortiguador
- 13- 4284 soporte amortiguador delantero
- 14- 90012 buje de rueda delantera
- 15- 96172 latiguillo freno delantero hasta '89
- 96173 latiguillo freno delantero desde '89

SUSPENSION TRASERA (salvo 4x4):

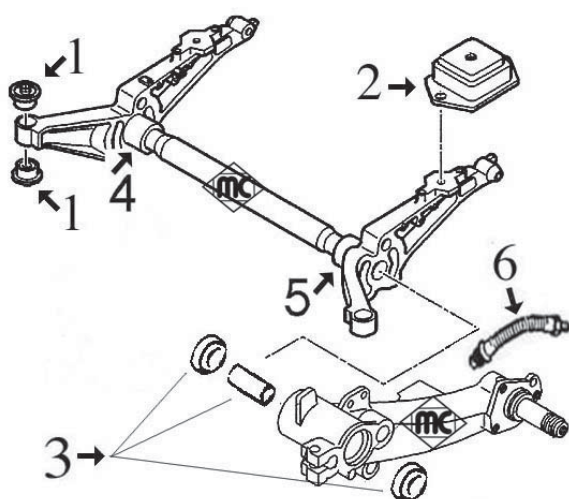

- 1- 4247 silentblocs puente trasero
- 2- 4038 soporte posterior puente
- 3- 4414 juego reparación brazo trasero completo con rodamientos, retenes y casquillos
- 4- 4552 eje brazo trasero derecho
- 5- 4551 eje brazo trasero izquierdo
- 6- 96096 latiguillo freno trasero (220 mm)

## PEUGEOT 405



**969**  
silentbloc anterior trapezio delantero  
r.o. 3523.40

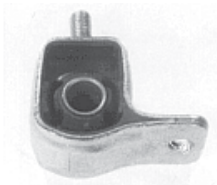

**966**  
silentbloc posterior trapezio delantero  
r.o. 3523.42

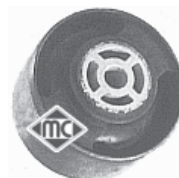

**2869**  
silentbloc de soporte de motor trasero  
r.o. 1809.16



**531**  
soporte de motor izquierdo todos  
r.o. 1843.95



**2794**  
soporte motor izquierdo TurboD desde '93  
r.o. 1827.10



**2943**  
soporte motor izquierdo automáticos, 4x4 y 2.0-16v, r.o. 1827.16

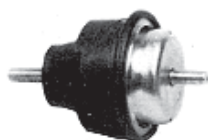

**697** **HIDRAULICO (650 g.)**  
soporte de motor derecho 1.1 - 1.4 y 1.8  
r.o. 1844.38

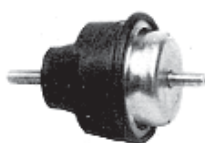

**697/1** **NO HIDRÁULICO (460 g.)**  
soporte de motor derecho 1.1 - 1.4 y 1.8  
r.o. ----



**2933**  
capuchón amortiguador delantero  
r.o. 5254.13



**2975**  
tope poliuretano suspensión anterior  
r.o. 5033.26



**4181**  
rodamiento soporte amortiguador  
r.o. 5035.27



**4284**  
soporte amortiguador delantero  
r.o.

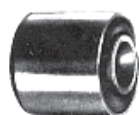

**877**  
silentbloc tirante trasero de motor  
r.o. 1809.04 (12x30x28x34)

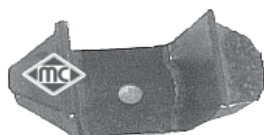

**2884**  
limitador soporte derecho de motor  
r.o. 1844.25



**2874**  
bieleta puntal barra estabilizadora  
r.o. 5087.27

**¡Nuevo!**



**4744**  
tirante posterior motor completo  
r.o.

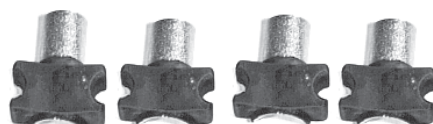

**2436** **Ø 21 mm**  
juego de CUATRO semicasquillos para barra estabilizadora, r.o. 5094.53



**2437** **Ø 22 mm**  
juego de CUATRO semicasquillos para barra estabilizadora, r.o. 5094.34



**4247**  
silentbloc puente trasero  
r.o. 5131.47

**¡Nuevo!**



**4551**  
eje brazo trasero izquierdo  
r.o.

**¡Nuevo!**



**4552**  
eje brazo trasero derecho  
r.o.



## PEUGEOT 405



**4038**  
soporte brazo trasero suspensión  
r.o.

**¡Nuevo!**



**4414**  
jgo. reparación brazo suspensión trasero  
con rodamientos, r.o. 5131.48-5132.49

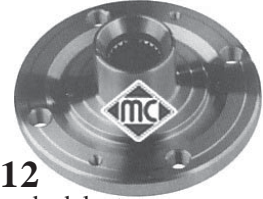

**90012**  
bujes de rueda delantera  
r.o. 3307.72



**96172**  
latiguillo freno delantero hasta '89 (510 mm)  
r.o. 4806.39



**96173**  
latiguillo freno delantero desde '89 (460 mm)  
r.o. 4806.42



**96096**  
latiguillo freno trasero (220 mm)  
r.o. 4806.40

long. máx: 130 mm  
long. mín: 90 mm  
rótulas de Ø 10 mm



**2347**  
bieleta selector de velocidades hasta '91  
r.o. 2454.A3-2454.C5

rótulas de Ø 13 mm



**2348**  
bieleta selector de velocidades hasta '91  
r.o. 2452.47

long. máx 135 mm  
long. mín. 86 mm  
rótulas de Ø 10 mm



**2865**  
bieleta selector de velocidades desde '91  
r.o. 2454.A3-2454.85

long. máx 300 mm  
long. mín. 240 mm  
rótulas de Ø 13 mm



**2866**  
bieleta selector de velocidades desde '91  
r.o. 2452.62

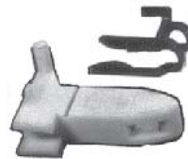

**2311**  
juego bieleta de cable embrague a pedal  
r.o. 2128.17+2138.04

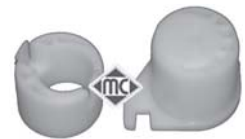

**4043**  
juego casquillos horquilla embrague  
r.o. 2175.20+2175.21



**4052**  
horquilla embrague completa con casquillos  
r.o. 2115.25

**¡Nuevo!**



**4424**  
casquillo guía embrague cambio motor TU  
r.o. 2105.14

**¡Nuevo!**



**4605**  
casquillo guía embrague cambio motor XU-  
XUD, r.o. 2105.35

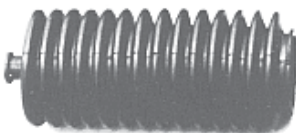

**1268**  
fuelle dcho+izqd cremallera manual y izqd  
cremallera asistida, r.o. 4066.27 - 4066.37

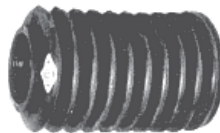

**1845**  
fuelle derecho cremallera asistida  
r.o. 4066.28 - 4066.30



**1310**  
fuelle izquierdo cremallera asistida d/ '93  
r.o.



**844**  
capuchón derecho cremallera asistida  
r.o. 4066.16

**¡Nuevo!**



**4612**  
varilla nivel aceite 1.9 Diesel  
r.o. 1174.15

**¡Nuevo!**



**4672**  
varilla nivel aceite motor gasolina XU  
r.o. 1172.79

PEUGEOT 405



**2926** Ø 156 mm - 6 canales  
polea cigüeñal Diesel y TurboD  
r.o.0515.G3

**¡Nuevo!**



**4481**  
polea cigüeñal 1.8/16v - 2.0/16v  
r.o.0515.K6

**¡Nuevo!**



**4485**  
polea cigüeñal 1.8/8v - 2.0/8v  
r.o.0515.H6



**2306**  
silentbloc pistón cremallera asistida Ø 20  
r.o.4059.06

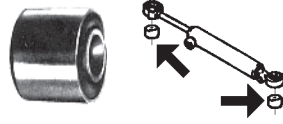

**2410**  
silentbloc pistón cremallera asistida Ø 22  
r.o.4059.07



**2911**  
silentbloc pistón cremallera asistida Ø 24  
r.o.4059.10



**1493-E**  
kit rep. transm. l/rda para montar en cono  
en neopreno especial de elasticidad 800%



**1493**  
kit rep. transm. l/rueda GL-GR-Diesel  
hasta '93, r.o. 3293.83



**1708**  
kit rep. transm. l/rda SRI-MI16 y TurboD  
hasta '93, r.o. 3293.91

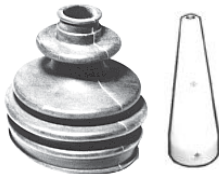

**1708-E** para montar con cono  
kit rep. transm. l/rda SRI-Mi-16 y TurboD  
hasta '93, r.o. 3293.91



**1626**  
kit rep. transm. l/cambio GL-GR-Diesel  
hasta '93, r.o. 3287.65



**1362**  
kit rep. transm. l/cambio SRI-MI16 y TD  
hasta '93, r.o. 3293.59



**2305**  
kit rep. transm. l/rda todos mods. desde '93  
r.o.3293.96



**1839**  
kit rep. transm. l/cambio todos desde '93  
r.o.3287.79

**¡Nuevo!**



**4564** Ø 30/47 y 40/58 mm  
juego retenes diferencial-transmisión  
r.o.3121.44+3121.46

**¡Nuevo!**



**3697**  
juego tapas correa distribución 1.4TU  
r.o.0320.S2+0320.L3

**¡Nuevo!**

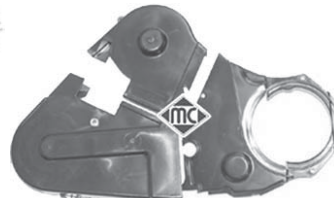

**3698**  
juego tapas correa distribución 1.9D-TD  
desde 1/94, r.o.0320.H2+0320.H3+0320.F9

**¡Nuevo!**



**4929** Ø 17-90 / 25 mm  
rodillo tensor correa alternador 1.8-2.0  
r.o.5751.20

**¡Nuevo!**



**4895**  
tensor correa alternador 1.8-2.0  
r.o.5751.35

**¡Nuevo!**



**4609**  
tensor correa alternador 1.9D-TD  
r.o.5751.38

## PEUGEOT 405



**2417**  
soporte tubo de escape (estrecho)  
r.o. 1755.53



**303**  
soporte tubo de escape (ancho)  
r.o. 1755.40



**084**  
soporte tubo de escape desde '93  
r.o. 1755.59



**2940** junta de Ø 80 x 66 mm  
kit montaje tubo de escape gasolina XU  
r.o.



**2392** junta de Ø 60 x 46 mm  
kit montaje tubo de escape 1.4 TU  
r.o. 1798.45



**2973** junta de Ø 60 x 46 mm  
kit montaje tubo de escape 1.9 Diesel  
r.o.



**4040**  
kit montaje tubo de escape TurboDiesel  
r.o.



**748** Ø 66 mm  
collarín tubo de escape  
r.o. 1713.16



**749** Ø 69 mm  
collarín tubo de escape  
r.o. 1713.35.



**2770**  
cubrepedal freno  
r.o. 4504.12



**2771**  
cubrepedal embrague  
r.o. 2130.13

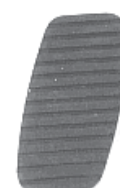

**2772**  
cubrepedal acelerador  
r.o. 1604.07



**2452**  
tapón cárter de aceite desde '91, 14x125  
r.o. 0311.14-0311.18



**2025**  
arandela tapón de cárter con retén Ø 16  
r.o.



**2024**  
arandela tapón de cárter con retén Ø 14  
r.o.



**667**  
tapón cárter de aceite hasta '91, 16x150  
r.o. 2221.11



**016**  
tapón cierre inyectores Diesel  
r.o.



**4036**  
bomba manual cebado gasoil con válvula  
antirretorno y boquilla adicional a 90°

CANALIZACIONES DE AGUA:

mgtos. 406 gasolina motores 1.6 (XU5JP), 1.8 (XU7JP)  
1.8-16v (XU7JP4) y 2.0-16v (XU10J4)

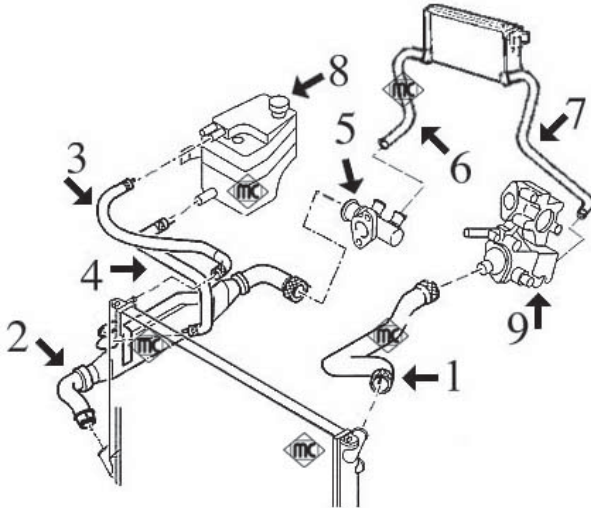

- 1- 8569 mgto superior radiador 1.6-1.8
- 8749 mgto superior radiador 1.8-16v y 2.0-16v
- 2- 8565 mgto inferior radiador todos sin aire acondic.
- 8566 mgto inferior radiador todos con aire acondic.
- 3- 8573 mgto de botella a radiador (sólo versiones con aire acondicionado)
- 4- 8590 mgto de botella a tubo metálico en mgto. inferior (sólo versiones con aire acondicionado)
- 5- 3523 racor plástico conexión mgtos.
- 6- 8582 mgto de calefactor a racor
- 7- 8581 mgto de calefactor a caja termostato
- 8- 3548 tapón de botella expansión/radiador (1.4 bar)
- 9- 3538 tapa de termostato 1.6-1.8
- n/d tapa de termostato 1.8-16v. - 2.0-16v.
- 3078 racor metálico en caja termostato
  
- 8854 mgto desvaporizador doble

mgtos. 406 1.9 TurboDiesel motores XUD9SD (75 CV) y XUD9TE (90 CV)

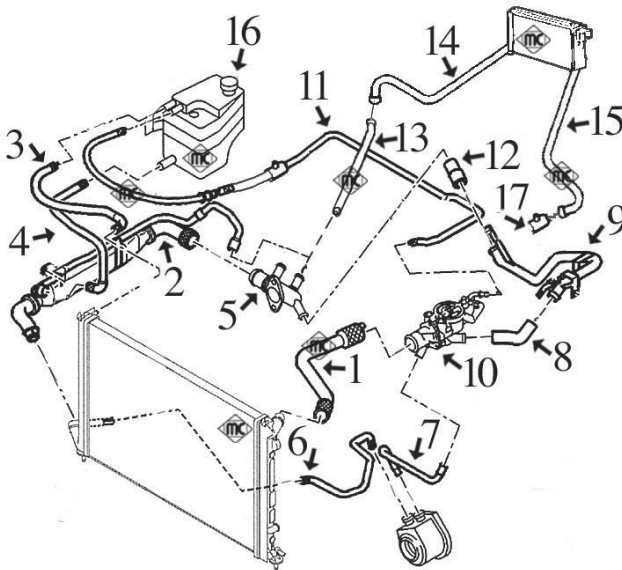

- 1- 8570 mgto superior radiador 1.9SD sin aire acond.
- 8571 mgto superior radiador 1.9SD con aire acond. y 1.9TE todos
- 2- 8567 mgto inferior radiador
- 3- 8573 mgto de botella a radiador, sólo versiones con aire acondicionado
- 117 mgto de botella a radiador sin aire acond., cortar de rollo MC-117 (Ø 10x16 mm) long. 1100 mm
- 4- 8572 mgto de botella a tubo metálico en mgto. inferior
- 5- 3503 racor plástico conexión mgtos.
- 6- 8576 mgto de intercambiador a radiador
- 7- 8313 mgto de intercambiador a caja termostato
- 8- 8183 mgto de caja termost. a tubo metálico hasta '99
- 8480 mgto de caja termost. a tubo metálico desde '99
- 9- 3057 tubo de agua metálico
- 10- 3539 tapa de termostato
- 3171 boquilla metálica en caja de termostato
- 11- 8577 mgto de caja termostato a botella
- 12- 8312 mgto de tubo metálico a racor
- 13- 8579 mgto de racor a mgto de calefacción
- 14- 8578 mgto derecho de calefactor
- 15- 8580 mgto de calefactor a boquilla en culata
- 16- 3548 tapón botella expansión 1.4 bar
- 17- 3059 boquilla metálica en culata



**mgts. 406 2.1 TurboDiesel motor XUD11BTE**

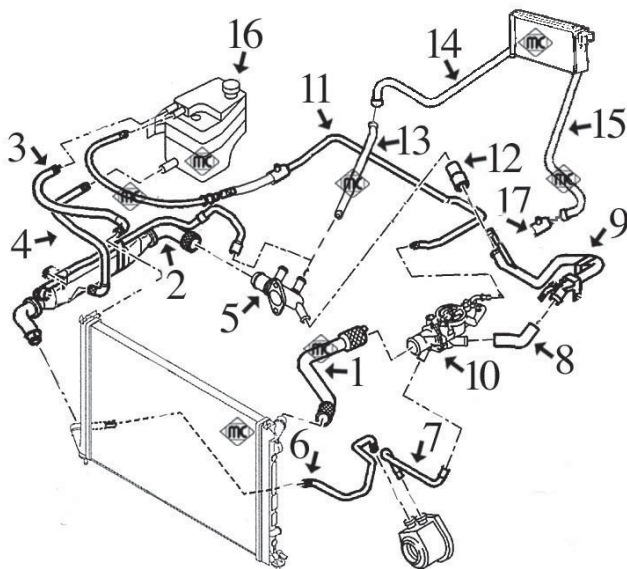

- 1- 8571 mgto superior radiador
- 2- 8574 mgto inferior radiador
- 3- 117 mgto de botella a radiador sin aire acondicionado, cortar de rollo MC-117 (Ø 10x16 mm), longitud 1100 mm
- 4- 8590 mgto de botella a tubo metálico en mgto. inferior
- 5- n/d racor plástico conexión mgts.
- 6- 8576 mgto de intercambiador a radiador
- 7- 8313 mgto de intercambiador a caja termostato
- 8- 8183 mgto de caja termost. a tubo metálico hasta '99
- 9- 3137 tubo de agua metálico
- 10- 3539 tapa de termostato
- 11- 8577 mgto de caja termostato a botella
- 12- n/d mgto de tubo metálico a racor
- 13- 3136 tubo de agua metálico empalme mgto calefactor
- 14- 8584 mgto derecho de calefactor
- 15- 8583 mgto de calefactor a caja termostato

**mgts. 406 2.0 HDi hasta 2000 (D8)**

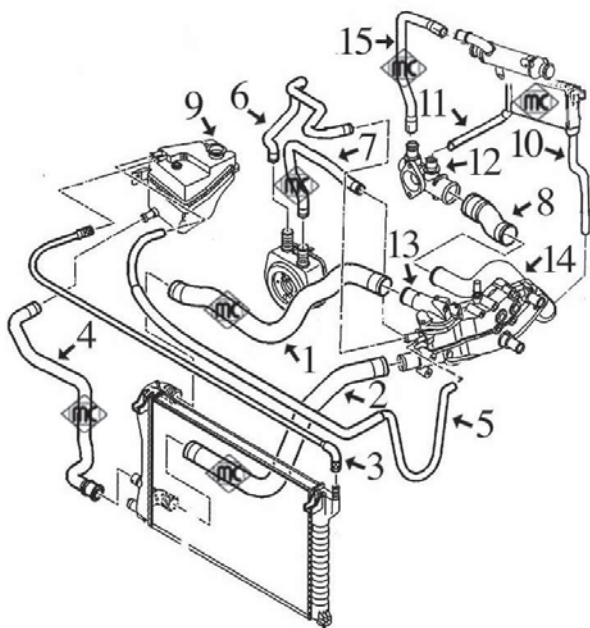

- 1- 8599 mgto superior radiador
- 2- 8600 mgto inferior radiador
- 3- 8603 mgto de botella a radiador (superior)
- 4- n/d mgto de botella a radiador (inferior)
- 5- 8604 mgto de botella a caja termostato
- 6- 8585 mgto de intercambiador a caja termostato
- 7- 8586 mgto de intercambiador a caja termostato
- 8- 8587 mgto de tubo metálico a racor plástico
- 9- 3548 tapón botella expansión 1.4 bar
- 10- 8588 mgto de calefactor a caja termostato
- 11- 8589 mgto de calefactor a racor
- 12- 3554 racor empalme mgts
- 13- 3135 tapa de termostato (aluminio)
- 3556 tapa de termostato (plástico)
- 14- 3139 tubo de agua metálico en caja temostato
- 15- 8668 mgto de racor a filtro de partículas

mgtos. 406 2.0 HDi desde 2000 (D9):

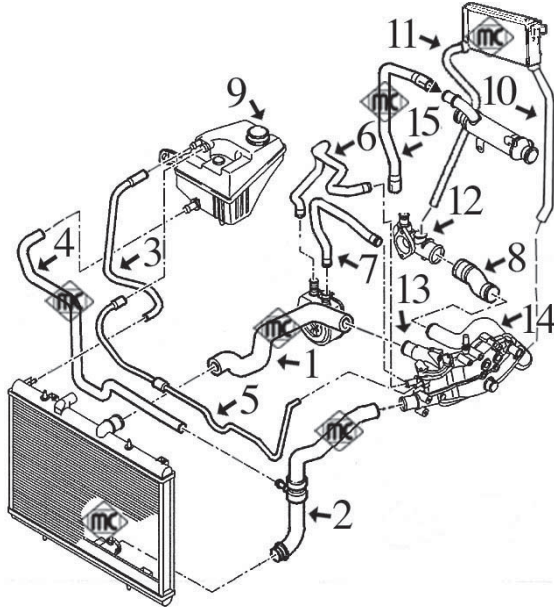

- 1- 8601 mgto superior radiador
- 2- 8602 mgto inferior radiador
- 3- 8605 mgto de botella a radiador (superior)
- 4- n/d mgto de botella a radiador (inferior)
- 5- 8604 mgto de botella a caja termostato
- 6- 8585 mgto de intercambiador a caja termostato
- 7- 8586 mgto de intercambiador a caja termostato
- 8- 8587 mgto de tubo metálico a racor plástico
- 9- 3548 tapón botella expansión 1.4 bar
- 10- 8588 mgto de calefactor a caja termostato
- 11- 8589 mgto de calefactor a racor
- 12- 3554 racor empalme mgtos
- 13- 3135 tapa de termostato (aluminio)
- 3556 tapa de termostato (plástico)
- 14- 3139 tubo de agua metálico en caja temostato
- 15- 8668 mgto de racor a filtro de partículas

mgtos. DESVAPORIZADORES 1.9 TurboD - 2.1 TurboD y 2.0 HDi

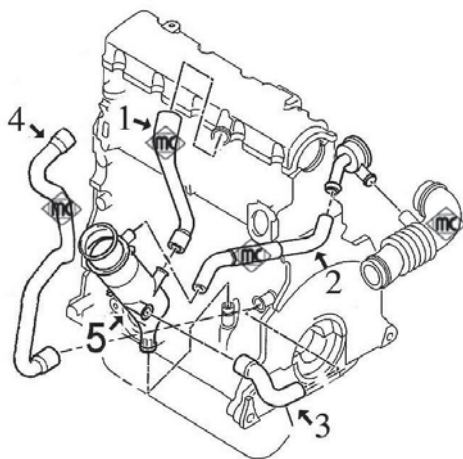

- 1- 8307 mgto de tapa balancines a decantador 1.9 TD
- 2- 8552 mgto de decantador a filtro de aire 1.9 TD
- 8636 mgto de tapa balancines a filtro aire HDi
- 3- 8166 mgto de cárter a decantador 1.9 TD y 2.1 TD
- 8540 mgto de cárter a culata motor 2.0 HDi
- 4- 8491 mgto de cárter a tapa balancines 2.1 TD
- 5- 3631 decantador completo con tapón 1.9TD-SD

PEUGEOT 406



**8166**  
mgto desvaporizador 1.9 TD  
r.o.1192.48



**8183**  
mgto de caja termostato a tubo metálico  
r.o. 1307.W3



**8307**  
mgto desvaporizador 1.9 TD  
r.o.1180.86



**8312**  
mgto de tubo metálico a racor  
r.o. 1307.W4



**8313**  
mgto de intercambiador a caja termostato  
r.o. 1307.AA



**8480**  
mgto de caja termostato a tubo metálico  
r.o.



**8491**  
mgto desvaporizador 2.1 TD  
r.o.



**8540**  
mgto desvaporizador 2.0 HDi  
r.o.



**8552**  
mgto desvaporizador 1.9 TD  
r.o.



**8565**  
mgto inferior radiador 1.6-1.8 gasolina  
sin aire ac., r.o.



**8566**  
mgto inferior radiador 1.6-1.8 gasolina  
con aire ac., r.o.



**8567**  
mgto inferior radiador 1.9 TD con o sin  
aire acond. (cambiar terminal con brida)



**8569**  
mgto superior radiador 1.6-1.8 gasolina  
r.o.



**8570**  
mgto superior radiador 1.9 TD sin aire ac.  
r.o.



**8571**  
mgto superior radiador 1.9 TD aire ac.  
r.o.



**8572**  
mgto de botella a mgto inferior radiador  
r.o.



**8573**  
mgto de botella a radiador 1.6-1.8 aire ac.  
r.o.



**8574**  
mgto inferior radiador 2.1 TD  
r.o.



**8576**  
mgto de intercambiador a radiador 1.9-2.1  
r.o.



**8577**  
mgto de caja termostato a botella  
r.o.



**8578**  
mgto de calefactor a racor 1.9 TD  
r.o.

**PEUGEOT 406**



**8579**  
mgto de racor a mgto calefactor 1.9 TD  
r.o.



**8580**  
mgto de calefactor a caja termost. 1.9 TD  
r.o.



**8581**  
mgto de calefactor a caja termost. 1.6-1.8  
r.o.



**8582**  
mgto de calefactor a racor 1.6-1.8-2.0  
r.o.



**8583**  
mgto de calefactor 2.1 TD  
r.o.



**8584**  
mgto de calefactor 2.1 TD  
r.o.



**8585**  
mgto intercambiador 2.0 HDi  
r.o.



**8586**  
mgto intercambiador 2.0 HDi  
r.o.



**8587**  
mgto de tubo metálico a racor 2.0 HDi  
r.o.



**8588**  
mgto calefactor 2.0 HDi  
r.o.



**8589**  
mgto calefactor 2.0 HDi  
r.o.



**8590**  
mgto de botella a mgto inferior 1.6-1.8  
r.o.



**8599**  
mgto superior radiador 2.0 HDi  
r.o.



**8600**  
mgto inferior radiador 2.0 HDi  
r.o.



**8601**  
mgto superior radiador 2.0 HDi  
r.o.



**8602**  
mgto inferior radiador 2.0 HDi  
r.o.



**8603**  
mgto de botella a radiador 2.0 HDi  
r.o.



**8604**  
mgto de botella a caja termostato 2.0 HDi  
r.o.



**8605**  
mgto de botella a radiador 2.0 HDi  
r.o.



**8636**  
mgto desvaporizador 2.0 HDi  
r.o.



**8668**  
mgto de racor a filtro partículas 2.0 HDi  
r.o.



PEUGEOT 406



**8749**  
mgto superior radiador 1.8-2.0 sin aire ac.  
r.o. 1307.W2



**8854**  
mgto desvaporizador doble 1.6-1.8  
r.o. 1180.62



**3057**  
tubode agua metálico 1.9 TD  
r.o. 1307.W2



**3059**  
boquilla en culata 1.9 TD  
r.o. 0245.44



**3078**  
boquilla en caja termostato 1.6-1.8-2.0  
r.o. 1336.K8



**3135**  
tapa de termostato 2.0 HDi  
r.o. 1336.P2



**3136**  
tubo de agua metálico 2.1 TD empalme  
tubo derecho de calefacción, r.o. 1341.59



**3137**  
tubo de agua metálico 2.1 TD con junta  
tórica, r.o. 1322.07+0236.42



**3139**  
tubo de agua metálico 2.0 HDi con junta  
tórica, r.o. 1307.YZ



**3171**  
boquilla metálica en caja termostato 1.9D-TD  
r.o. 1336.N7

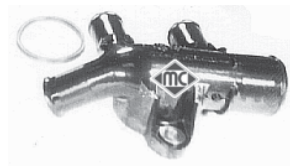

**3503**  
racor conexión manguitos 1.9 TD  
r.o. 1336.G4

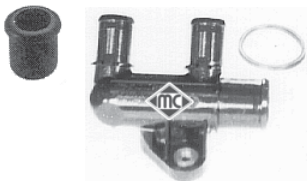

**3523**  
racor conexión manguitos 1.6-1.8-2.0  
r.o. 1336.J7-1336.H7



**3538**  
tapa de termostato 1.6-1.8  
r.o. 1336.A1



**3539**  
tapa de termostato 1.9 TD  
r.o. 1336.C9



**3548**  
tapón botella expansión  
r.o. 1336.C7-1336.84



**3554**  
racor conexión manguitos 2.0 HDi  
r.o. 1336.P5



**3556**  
tapa de termostato 2.0 HDi (plástico)  
r.o. 1336.R9



**3631**  
decantador completo con tapón 1.9TD-SD  
r.o. 1180.95

SUSPENSION DELANTERA y SOPORTES

MOTORES DE GASOLINA:

1.6 (XU5JP), 1.8 (XU7JP), 1.8-16v (XU7JP4) y 2.0-16v (XU10J4)

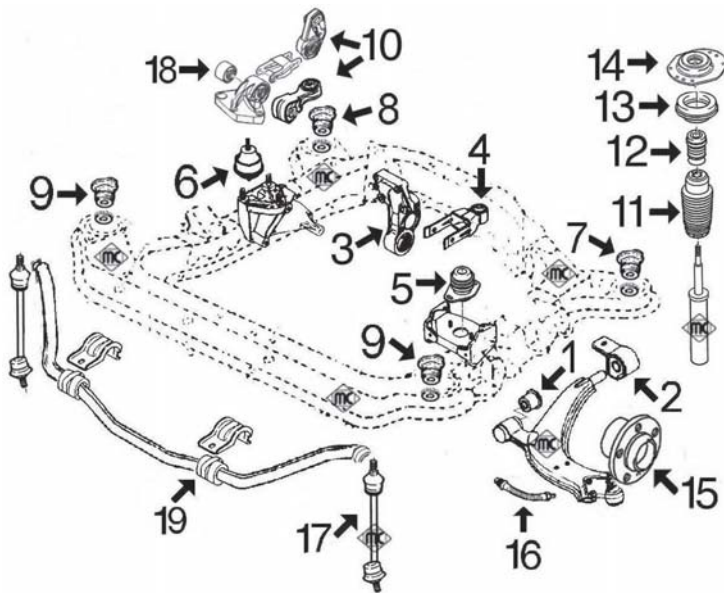

- 1- 2679 silentbloc anterior trapecio delantero
- 2- 2678 silentbloc posterior trapecio delantero
- 3- 2869 silentbloc soporte post. motor 1.6-1.8 salvo 16v  
2980 silentbloc soporte post. motor 1.8/16v - 2.0-16v
- 4- 4744 tirante posterior motor completo  
877 silentbloc tirante posterior de motor
- 5- 531 soporte motor izquierdo 1.6-1.8 salvo 16v  
2794 soporte motor izquierdo 1.8-16v - 2.0-16v
- 6- 2309 soporte motor derecho
- 7- 4964 silentbloc posterior- izquierdo puente delantero, juego completo de 2 piezas
- 8- 4905 silentbloc posterior-derecho puente delantero, juego completo de 2 piezas
- 9- 4966 silentbloc anterior puente delantero (derecho e izquierdo), juego completo de 2 piezas
- 10- 4006 bieleta antipar hasta 9/'98  
4486 bieleta antipar desde 10/'98
- 11- 2933 capuchón amortiguador delantero
- 12- 2934 tope poliuretano suspensión delantera
- 13- 4204 rodamiento soporte amortiguador
- 14- 2930 soporte amortiguador
- 15- 90012 buje de rueda delantera
- 16- 96190 latiguillo freno delantero derecho (575 mm)  
96196 latiguillo freno delantero izquierdo (575 mm)
- 17- 2968 bieleta puntal barra estabilizad. hasta 11/'97  
4046 bieleta puntal barra estabilizad. desde 11/'97
- 18- 2869 silentbloc soporte bieleta antipar hasta 9/'98
- 19- 4047 goma soporte barra estabilizadora Ø 23 mm  
4048 goma soporte barra estabilizadora Ø 24 mm

SUSPENSION DELANTERA y SOPORTES

MOTORES DIESEL:

1.9 STDT (XUD9SD), 1.9 TD (XUD9TE), 2.1 TD (XUD11BTE) y 2.0 HDi (DW10)

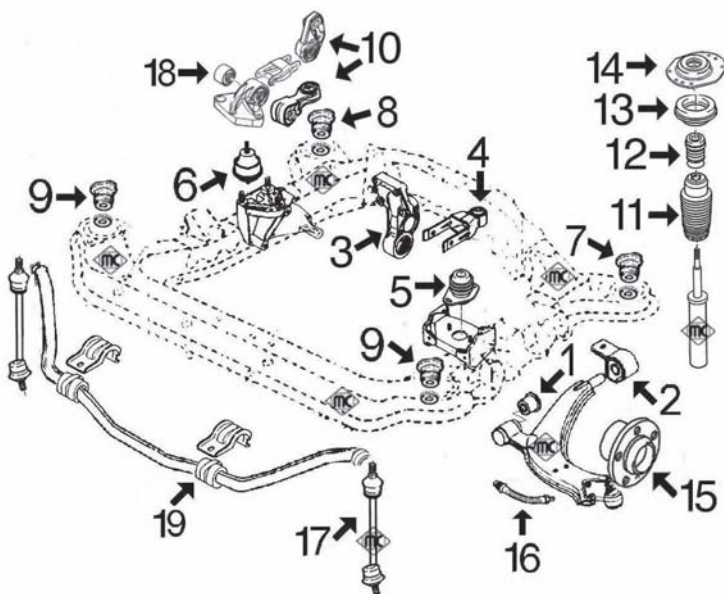

- 1- 2679 silentbloc anterior trapecio delantero
- 2- 2678 silentbloc posterior trapecio delantero
- 3- 2980 silentbloc soporte post. motor 1.9TD - 2.1TD  
2966 silentbloc soporte post. motor 2.0 HDi
- 4- 4744 tirante posterior motor completo  
877 silentbloc tirante posterior de motor
- 5- 2794 soporte motor izquierdo 1.9 TD  
2943 soporte motor izquierdo 2.1 TD - 2.0 HDi
- 6- 2309 soporte motor derecho
- 7- 4964 silentbloc posterior- izquierdo puente delantero, juego completo de 2 piezas
- 8- 4905 silentbloc posterior-derecho puente delantero, juego completo de 2 piezas
- 9- 4966 silentbloc anterior puente delantero (derecho e izquierdo), juego completo de 2 piezas
- 10- 4006 bieleta antipar 1.9 TD - 2.1 TD hasta 9/'98  
4486 bieleta antipar 1.9 TD - 2.1 TD desde 10/'98  
4005 bieleta antipar 2.0 HDi
- 11- 2933 capuchón amortiguador delantero
- 12- 2934 tope poliuretano suspensión delantera
- 13- 4204 rodamiento soporte amortiguador
- 14- 2930 soporte amortiguador
- 15- 90012 buje de rueda delantera
- 16- 96190 latiguillo freno delantero derecho (575 mm)  
96196 latiguillo freno delantero izquierdo (575 mm)
- 17- 2968 bieleta puntal barra estabilizad. hasta 11/'97  
4046 bieleta puntal barra estabilizad. desde 11/'97
- 18- 2869 silentbloc soporte bieleta antipar hasta 9/'98
- 19- 4047 goma soporte barra estabilizadora Ø 23 mm  
4048 goma soporte barra estabilizadora Ø 24 mm

**BRAZOS SUSPENSION TRASERA Y MANGUETA**

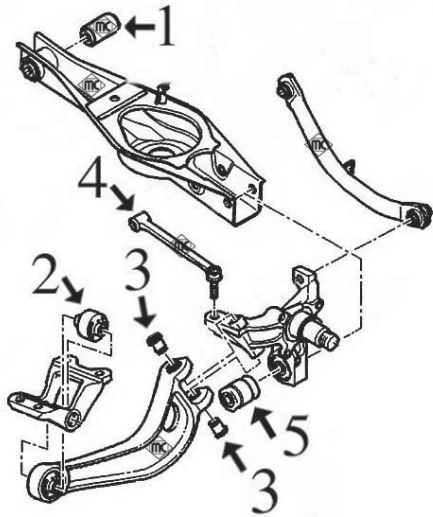

- 1- 4007 silentbloc brazo superior trasero
- 2- 4009 silentbloc anterior brazo suspensión
- 3- 4008 silentbloc posterior brazo suspensión
- 4- 4331 bieleta tirante reacción trasero
- 5- 4591 silentbloc hidráulico mangueta

**TRAVIESA SUSPENSION TRASERA Y BARRA ESTABILIZADORA:**

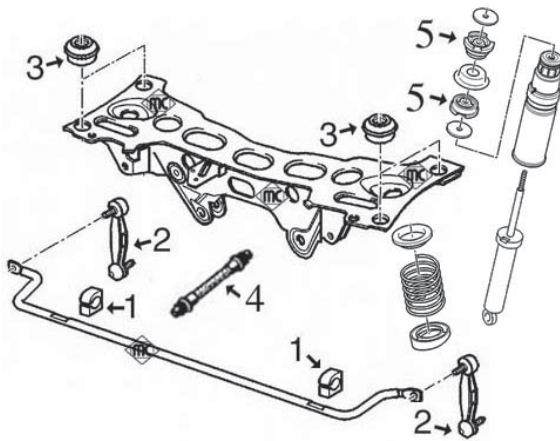

- 1- 4054 goma barra estabilizadora trasera Ø 21 mm
- 4055 goma barra estabilizadora trasera Ø 22 mm
- 2- 4056 bieleta puntal barra
- 3- 4830 silentbloc soporte sub-chasis
- 4- 96191 latiguillo freno trasero (305 mm)
- 5- 4904 silentbloc soporte amortiguador trasero

**PEUGEOT 406**



**531**  
soporte motor izquierdo 1.6-1.8  
r.o. 1843.95

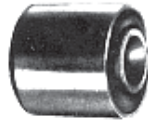

**877**  
silentbloc tirante posterior motor  
r.o. 1809.04(12x30x28x34)



**2309** **HIDRÁULICO (950 g.)**  
soporte motor derecho  
r.o. 1827.23-1827.28-1844.82-1827.25



**2678**  
silentbloc posterior trapecio delantero  
r.o. 3523.61



**2679**  
silentbloc anterior trapecio delantero  
r.o. 3523.60



**2794**  
soporte motor izquierdo 1.8-16v/2.0-16v  
y 1.9 TD, r.o. 1827.10



**2869**  
silentbloc soporte posterior motor 1.6-1.8  
r.o. 1809.16



**2930**  
soporte amortiguador delantero  
r.o. 5038.25



**2933**  
capuchón amortiguador delantero  
r.o. 5254.26



**2934**  
tope poliuretano suspensión delantera  
r.o. 5033.40



**2943**  
soporte motor izquierdo 2.1TD - 2.0 HDi  
r.o. 1827.16



**2966**  
silentbloc soporte post. motor 2.0 HDi  
r.o. 1809.30



**2968**  
bieleta puntal barra estabilizadora del.  
hasta PR-7664, r.o. 5087.40



**2980**  
silentbloc soporte posterior motor 16v y TD  
r.o. 1809.21



**4005**  
bieleta antipar 2.0 HDi  
r.o. 1806.28



**4006**  
silentbloc bieleta antipar 1.6-1.8-1.9TD-  
2.1 TD, r.o. 1854.20



**4007**  
silentbloc brazo superior trasero suspensión  
r.o. 5131.80



**4008**  
silentbloc posterior brazo suspensión tras.  
r.o. 5131.78



**4009**  
silentbloc anterior brazo suspensión tras.  
r.o. 5131.79



**4046**  
bieleta puntal barra estabilizadora desde  
PR-7665, r.o. 5087.48



**4047** **con ánima metálica !**  
goma para barra estabilizadora delantera  
Ø 23 mm, r.o. 5094.74



PEUGEOT 406



**4048** con ánima metálica !  
goma para barra estabilizadora delantera  
Ø 24 mm, r.o. 5094.75



**4054** con ánima metálica !  
goma para barra estabilizadora trasera  
Ø 21 mm, r.o. 5172.42



**4055** con ánima metálica !  
goma para barra estabilizadora trasera  
Ø 22 mm, r.o. 5172.43



**4056**  
bieleta puntal barra estabilizadora trasera  
r.o. 5178.38



**4204**  
rodamiento soporte amortiguador delant.  
r.o.



**4331**  
bieleta tirante reacción mangueta trasera  
r.o.

**¡Nuevo!**



**4744**  
tirante posterior motor completo  
r.o.

**¡Nuevo!**

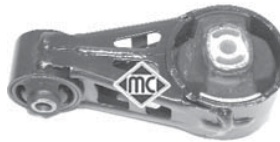

**4486**  
bieleta antipar desde 10/98  
r.o. 1806.34

**¡Nuevo!**



**4591**  
silentbloc hidráulico mangueta trasera  
r.o. 3640.35

**¡Nuevo!**



**4830**  
silentbloc soporte puente trasero  
r.o. 5152.59

**¡Nuevo!**



**4904**  
silentbloc soporte amortiguadores traseros  
r.o. 5161.20-5161.23

**¡Nuevo!**



**4905**  
juego silentbloc posterior-derecho puente  
delantero, r.o. 3504.07+3504.18

**¡Nuevo!**



**4964**  
juego silentbloc posterior-izquierdo puente  
delantero, r.o. 3504.06+3504.18

**¡Nuevo!**



**4966**  
juego silentbloc anterior (derecho e izqdo.)  
puente delantero, r.o. 3504.08+3504.18

**¡Nuevo!**



**90012**  
buje de rueda delantera  
r.o. 3307.02



**96190**  
latiguillo freno delantero **derecho** (575 mm)  
r.o. 480680



**96196**  
latiguillo freno delantero **izquierdo** (575 mm)  
r.o. 480679



**96191**  
latiguillo freno trasero (305 mm)  
r.o. 480678

PEUGEOT 406



**2926**  
polea cigueñal 1.9 TD (motor XU)  
r.o. 0515.G3



**2976**  
polea cigueñal 2.1 TD  
r.o. 0515.J9



**2928**  
polea cigueñal 2.0 HDi hasta '7/'02  
r.o. 0515.P2

**¡Nuevo!**



**4477**  
polea cigueñal 2.0HD-2.2HDi desde 7/'02  
r.o. 0515.R2

**¡Nuevo!**



**4485**  
polea cigueñal 1.8-2.0 (motor XU)  
r.o. 0515.H6

**¡Nuevo!**



**4481**  
polea cigueñal 1.8/16v-2.0/16v (motor XU)  
r.o. 0515.K6

**¡Nuevo!**



**4562**  
polea cigueñal 1.8/16v-2.0/16v (motor EW)  
r.o. 0515.R1

**¡Nuevo!**



**4443**  
polea cigueñal 2.0/16v motor EW desde '04  
r.o. 0515.N3



**2931**  
tensor correa alternador 1.9 TD completo  
r.o. 5751.81

**¡Nuevo!**



**4991**  
articulación reenvío cambio completa con  
casquillos, r.o.

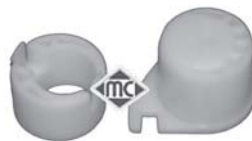

**4043**  
juego casquillos horquilla embrague 1.9TD  
r.o. 2175.20+2175.21



**4044**  
juego casq. horquilla embrague con re-  
tienes 2.1TD/2.0HDi, r.o. 2175.49-2109.53

**¡Nuevo!**



**4605**  
casquillo guía embrague con retén  
r.o. 2105.35

**¡Nuevo!**



**4799**  
horquilla embrague completa 2.0HDi hasta  
'01, 2.2HDi, V6 y 2.1TD, r.o. 2117.59

**¡Nuevo!**



**4601**  
horquilla embrague 1.8/2.0/2.2 motor EW  
r.o. 2117.66



**4052**  
horquilla embrague completa 1.9 TD  
con casquillos, r.o. 2115.25



**2865**  
bioleta mando reenvío cambio velocidades  
r.o. 2454.E5



**2866**  
bioleta mando reenvío cambio velocidades  
r.o. 2452.76

**¡Nuevo!**



**4612**  
varilla nivel aceite 1.9TD  
r.o. 1174.15

**¡Nuevo!**



**4594**  
varilla nivel aceite 2.0HDi  
r.o.

**¡Nuevo!**



**3642**  
tapón llenado aceite 2.0HDi  
r.o. 1180.F9

**PEUGEOT 406**



**1515**  
fuelle izquierdo cremall. asistida "variable"  
r.o. 4066.42



**1470**  
fuelle izquierdo cremallera asistida  
"no variable", r.o. 4066.60



**1845**  
fuelle derecho cremall. asistida "variable"  
r.o.



**1536**  
fuelle derecho cremallera asistida "no varia-  
ble", r.o.



**844**  
capuchón derecho cremallera  
r.o. 4066.20



**1222**  
kit rep. transmisión l/rda. 1.6-1.8-1.9D-  
1.9TD, r.o. 3293.03



**1213**  
kit rep. transmisión l/cbo 1.6-1.8-1.9D/TD  
r.o. 3287.81



**1460**  
kit rep. transmisión l/rda. 2.1TD-2.0HDi  
r.o. 3293.02



**1467**  
kit rep. transmisión l/cbo. 2.1TD-2.0HDi  
r.o. 3287.80

**¡Nuevo!**



**4564**  
juego retenes diferencial-transmisión 1.6-1.8-  
1.9TD, r.o. 3121.44+3121.46

**¡Nuevo!**



**4620**  
juego retenes diferencial-transmisión 2.0-  
2.1TD-2.0HDi, r.o. 3121.24+3121.44

**¡Nuevo!**



**4479**  
juego soporte tapa motor 2.0HDi  
r.o. 0137.11+0137.23

**¡Nuevo!**

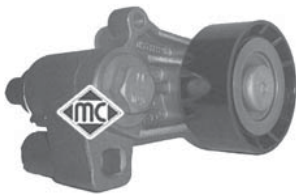

**4826**  
tensor correa alternador 1.9TD con A/C  
r.o. 5751.30

**¡Nuevo!**



**4609**  
tensor correa alternador 1.9TD sin A/C  
r.o. 5751.38

**¡Nuevo!**

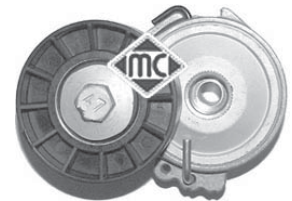

**4807**  
tensor correa alternador 2.0HDi  
r.o. 5751.55

**¡Nuevo!**

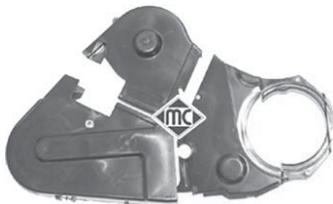

**3698**  
juego tapas correa distribución 1.9D  
r.o. 0320.H2+0320.H3+0320.F9

**¡Nuevo!**



**3699**  
juego tapas correa distribución 2.0HDi  
r.o. 0320.N5+0320.N6+0320.S7

**¡Nuevo!**



**4895**  
tensor correa alternador 1.8-2.0  
r.o. 5751.35

**¡Nuevo!**



**4929**      **Ø 17-90 / 25 mm**  
rodillo tensor correa alternador 1.8-2.0  
r.o. 5751.20

**¡Nuevo!**



**4995**  
rodillo tensor correa alternador 1.9DW8 y  
2.0HDi con A/C, r.o. 5751.29

**¡Nuevo!**



**4996**  
rodillo tensor correa alternador 2.0HDi sin  
A/C, r.o. 5751.96-5751.57



PEUGEOT 406

**¡Nuevo!**



**4915** Ø 54,60 mm  
polea de alternador de rueda libre  
r.o.

**¡Nuevo!**



**4916** Ø 58,50 mm  
polea de alternador de rueda libre  
r.o.



**4036**  
bomba manual cebado gasoil con válvula  
antirretorno y boquilla adicional a 90°



**2940** junta de Ø 80 x 66 mm  
kit montaje colector 1.6-1.8-2.0-2.1  
r.o.



**4040** junta de Ø 71 x 58 mm  
kit montaje colector 1.9 TurboD "XUDST"  
r.o.



**4041** junta de Ø 71 x 58 mm  
kit montaje colector 1.9 TurboD "XUDTE"  
r.o.



**2753**  
soporte tubo de escape  
r.o. 1755.69



**4042**  
soporte tubo de escape HDi  
r.o. 1755.84



**2452**  
tapón cárter aceite 14x125  
r.o. 0311.21



**2770**  
cubrepedal freno  
r.o. 4504.12



**2771**  
cubrepedal embrague  
r.o. 2130.13



**2772**  
cubrepedal acelerador  
r.o. 1604.07



**2024**  
arandela tapón cárter  
r.o.



**2050**  
arandela tapón cárter 14x22 HDi  
r.o. 0313.27





SUSPENSION DELANTERA y SOPORTES DE MOTOR:

1.8/16v gasolina motor EW7J4  
 2.0/16v gasolina motor EW10J4  
 2.2/16v gasolina motor EW12J4  
 1.6/16v HDi motor DV6TED4  
 2.0/16v HDi motor DW10BTED4:

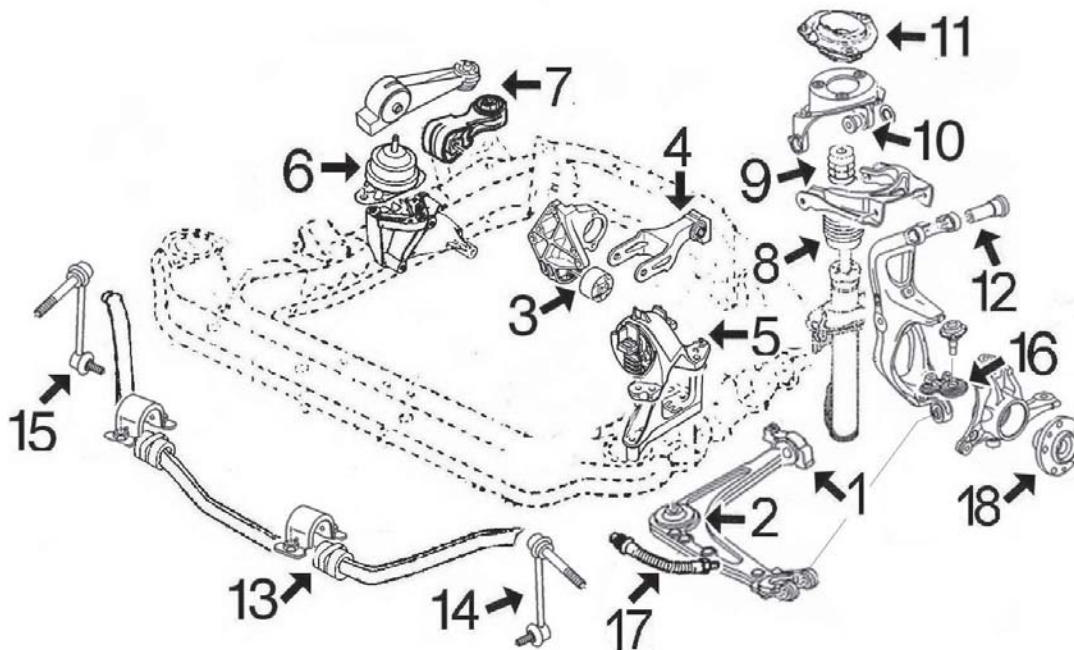

- 1- 4957 silentbloc posterior trapecio delantero
- 2- 4970 silentbloc anterior trapecio delantero
- 3- 2980 silentbloc soporte posterior motor 1.8/2.0 gasolina y 2.0HDi
- 4428 silentbloc soporte posterior motor 2.2 gasolina y 1.6HDi
- 4- n/d tirante posterior motor
- 5- n/d soporte motor izquierdo 1.8 gasolina y 1.6HDi
- 4613 soporte motor izquierdo 2.0/2.2 gasolina y 2.0HDi
- 6- 4806 soporte motor derecho 1.6HDi
- 2942 soporte motor derecho 1.8/2.0/2.2 gasolina y 2.0HDi
- 7- 4614 tirante reacción derecho 2.2 gasolina
- 4005 tirante reacción derecho 1.6HDi-2.0HDi
- n/d tirante reacción derecho 1.8/2.0 gasolina
- 8- n/d capuchón amortiguador delantero
- 9- n/d tope poliuretano amortiguador delantero
- 10- n/d silentbloc brazo superior de suspensión
- 11- n/d soporte amortiguador delantero con rodamiento
- 12- n/d silentbloc pasador mangueta delantera
- 13- n/d goma barra estabilizadora
- 14- 4801 bieleta puntal izquierdo barra estabilizadora
- 15- 4802 bieleta puntal derecho barra estabilizadora
- 16- 5045 pivote inferior rótula soporte mangueta
- 17- n/d latiguillo freno delantero
- 18- n/d buje rueda delantera

PEUGEOT 407



**2942**  
soporte motor derecho 1.8-2.0-2.2-2.0HDi  
r.o. 1844.92



**2980**  
silentbloc soporte motor trasero 1.8-2.0-2.0HDi, r.o. 1809.21



**4005**  
bieteleta antipar 1.6HDi-2.0HDi  
r.o. 1806.28

**iNuevo!**



**4428**  
silentbloc soporte trasero motor 2.2-1.6HDi  
r.o. 1809.33

**iNuevo!**

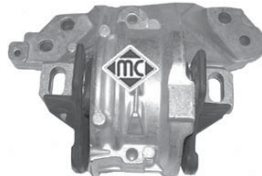

**4613**  
soporte motor izqdo. 2.0-2.2-2.0HDi  
r.o. 1813.98

**iNuevo!**



**4614**  
bieteleta antipar 2.2 gasolina  
r.o. 1806.52

**iNuevo!**



**4801**  
bieteleta **izquierda** puntal barra estabilizadora  
delantera, r.o. 5087.52

**iNuevo!**



**4802**  
bieteleta **derecha** puntal barra estabilizadora  
delantera, r.o. 5087.53

**iNuevo!**



**4803**  
bieteleta barra estabilizadora **trasera**  
r.o. 5178.46

**iNuevo!**



**4806**  
soporte motor derecho 1.6 HDi  
r.o. 1807.Y3

**iNuevo!**

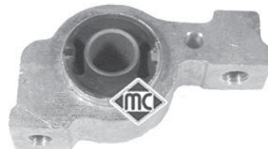

**4957**  
silentbloc posterior trapecio delantero  
r.o.

**iNuevo!**



**4970**  
silentbloc anterior trapecio delantero  
r.o. 3523.AQ

**iNuevo!**



**5045**  
pivote inferior rótula soporte mangueta  
r.o. 3640.72-3640.58

**iNuevo!**



**4601**  
horquilla embrague 1.8-2.0-2.2-2.0HDi  
r.o. 2117.66

**iNuevo!**



**4605**  
casquillo guía embrague con retén 1.6HDi-1.8-2.0, r.o. 2105.35

**iNuevo!**



**4562**  
polea cigueñal 1.8-2.0-2.2 (motores EW)  
r.o. 0515.R1

**iNuevo!**



**4738**  
polea cigueñal 2.0HDi/16v  
r.o. 0515.Q8

**iNuevo!**



**4441**  
polea cigueñal 1.6HDi  
r.o. 0515.R0

**iNuevo!**



**4602**  
bieteleta mando cambio velocidades  
r.o.

**iNuevo!**



**4564**      Ø 30/47 y 40/58 mm  
juego retenes diferencial-transmisión 1.8-2.0  
r.o. 3121.44+3121.46

**iNuevo!**



**4620**      Ø 32/50 y 40/58 mm  
juego retenes diferencial-transmisión  
2.0HDi, r.o. 3121.24+3121.44

PEUGEOT 407

<p><b>¡Nuevo!</b></p>  <p><b>1113</b> kit fuelle l/rda 1.6HDi-1.8-2.0 r.o. 3293.31</p>	 <p><b>1213</b> kit fuelle l/cambio 1.6HDi-1.8-2.0 r.o. 3287.81</p>	 <p><b>1460</b> kit fuelle l/rda 2.2-2.0HDi r.o. 3293.02</p>
<p><b>¡Nuevo!</b></p>  <p><b>1110</b> kit fuelle l/cambio 2.2-2.0HDi r.o. 3287.96</p>	<p><b>¡Nuevo!</b></p>   <p><b>3642</b> tapón llenado aceite 1.6HDi r.o. 1180.F9</p>	<p><b>¡Nuevo!</b></p>   <p><b>3659</b> tapón llenado aceite 1.8-2.0-2.2 r.o. 0258.65</p>
<p><b>¡Nuevo!</b></p>  <p><b>4915</b> polea de alternador de rueda libre Ø 54,60 mm r.o.</p>	<p><b>¡Nuevo!</b></p>  <p><b>4916</b> polea de alternador de rueda libre Ø 58,50 mm r.o.</p>	
 <p><b>3560</b> tapón botella de expansión r.o. 1306.E4</p>	 <p><b>2452</b> tapón cárter aceite 14x125 todos salvo 1.6HDi, r.o. 0311.21</p>	 <p><b>2929</b> tapón cárter aceite 10x125 1.6HDi r.o. 0311.29</p>
 <p><b>2770</b> cubrepedal freno r.o. 4504.12</p>	 <p><b>2771</b> cubrepedal embrague r.o. 2130.13</p>	 <p><b>2772</b> cubrepedal acelerador r.o. 1604.07</p>

PEUGEOT 504 - 505



**7595**  
mgto superior radiador 505 D motor 2.3  
r.o. 1343.61



**7996**  
mgto inferior radiador 505 inyección  
r.o. 1350.62



**7576**  
mgto superior radiador 505 D motor 2.5  
r.o. 1343.36



**7577**  
mgto inferior radiador 505 D motor 2.5  
r.o. 1350.46



**7995**  
mgto superior radiador 505 TurboDiesel  
r.o. 1343.49



**7578**  
mgto de bomba a tubo 505 Diesel todos  
r.o. 1350.27 - 1343.50



**408**  
soporte de motor 504 todos y 505 (salvo  
Diesel e inyección), r.o. 1807.25



**2328**  
goma barra estabilizadora  
r.o. 5094.09



**3608**  
tapón radiador 1.2 bar  
r.o. 1306.85

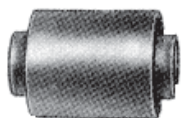

**133**  
silentbloc punta brazo delantero 504-505  
r.o. 3523.16 (14x33x32x44)



**364**  
silentbloc central brazo delantero  
r.o. 3523.10



**365**  
silentbloc tirante brazo delantero  
r.o. 3561.09

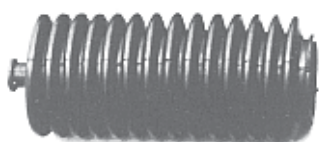

**268**  
fuelle dcho+izqd cremallera manual y dcho  
cremallera asistida 505, r.o. 4066.20



**2410**  
silentbloc pistón cremallera asistida  
r.o. 4059.07



**374**  
flector de dirección  
r.o. 1584.78



**536**  
fuelle derecho cremallera asistida 505  
r.o. 4066.22



**844**  
capuchón derecho cremallera asistida  
r.o. 4066.16



**667**  
tapón cárter aceite Ø 16 M-150  
r.o. 0163.21



**4605**  
casquillo guía embrague con retén  
r.o. 2105.35

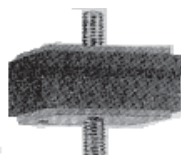

**378**  
soporte tubo de escape  
r.o.



SUSPENSION DELANTERA y SOPORTES DE MOTOR

2.1 Diesel motor XUD11

2.0 gasolina 2.0 motores XU10J2 y XU10J2TE (Turbo)



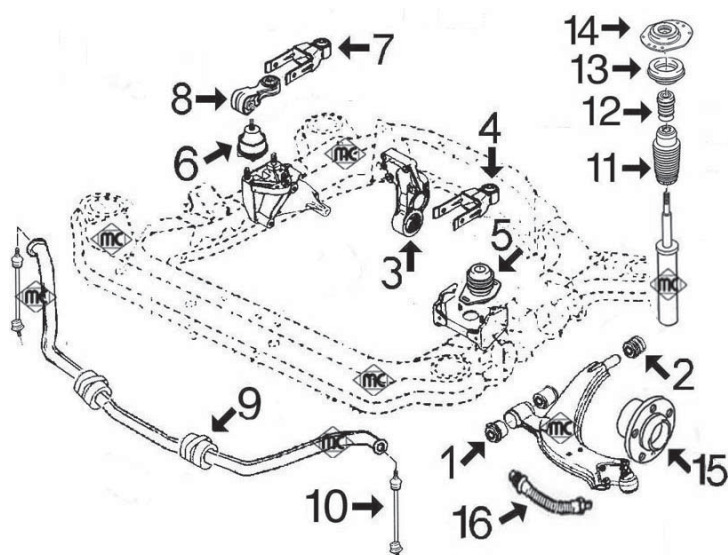

















(versiones no disponibles: Diesel Turbo motor DK5ATE ni 3.0 gasolina V6)



- 1- 4963 silentbloc anterior trapecio delantero
- 2- 4962 silentbloc posterior trapecio delantero
- 3- 2869 silentbloc soporte posterior motor hasta '94  
2980 silentbloc soporte posterior motor desde '94
- 4- 4744 tirante posterior motor
- 5- 2794 soporte motor izquierdo 2.0 gasolina  
2943 soporte motor izquierdo 2.1 Diesel
- 6- 2924 soporte motor derecho 2.0 gasolina  
2944 soporte motor derecho 2.1 Diesel
- 7- 4745 bieleta antipar en soporte derecho 2.0-2.1D
- 8- n/d tirante de reacción
- 9- 2412 goma barra estabilizadora
- 10- 4959 bieleta puntal barra estabilizadora
- 11- 2933 capuchón amortiguador delantero
- 12- 2934 tope poliuretano amortiguador delantero
- 13- 4204 rodamiento soporte amortiguador
- 14- n/d soporte amortiguador delantero
- 15- n/d buje rueda delantera
- 16- n/d latiguillo freno delantero

 <p><b>2412</b> goma barra estabilizadora r.o. 5094.70</p>	 <p><b>2794</b> soporte motor izquierdo 2.0 gasolina r.o. 1827.10</p>	 <p><b>2869</b> silentbloc en soporte motor trasero hasta '94, r.o. 1809.16</p>
 <p><b>2924</b> soporte motor derecho 2.0 gasolina r.o. 1827.22</p>	 <p><b>2933</b> capuchón amortiguador delantero r.o.</p>	 <p><b>2934</b> tope poliuretano suspensión delantera r.o. 5033.40</p>
 <p><b>2943</b> soporte motor izquierdo 2.1 Diesel r.o. 1827.16</p>	 <p><b>2944</b> soporte motor derecho 2.1 Diesel r.o.</p>	 <p><b>2980</b> silentbloc en soporte motor trasero desde '94-, r.o. 1809.21</p>

## PEUGEOT 605

<p><b>¡Nuevo!</b></p>  <p><b>4204</b> rodamiento soporte amortiguador delantero r.o. 5035.32</p>	<p><b>¡Nuevo!</b></p>  <p><b>4744</b> tirante posterior motor r.o. 1854.16</p>	<p><b>¡Nuevo!</b></p>  <p><b>4745</b> bioleta en tirante de reacción derecho r.o. 1854.14</p>
<p><b>¡Nuevo!</b></p>  <p><b>4959</b> bioleta puntal barra estabilizadora r.o. 5087.49</p>	<p><b>¡Nuevo!</b></p>  <p><b>4962</b> silentbloc posterior trapecio delantero r.o. 3523.96-3523.45</p>	<p><b>¡Nuevo!</b></p>  <p><b>4963</b> silentbloc anterior trapecio delantero r.o. 3523.43</p>
<p><b>¡Nuevo!</b></p>  <p><b>4960</b> bioleta <b>izquierda</b> barra estabilizadora trasera r.o. 5178.43</p>	<p><b>¡Nuevo!</b></p>  <p><b>4961</b> bioleta <b>derecha</b> barra estabilizadora trasera r.o. 5178.44</p>	
 <p><b>4411</b> polea cigueñal 2.1 Diesel hasta '95 r.o. 0515.F8</p>	 <p><b>2976</b> polea cigueñal 2.1 Diesel desde '95 r.o. 0515.J9</p>	 <p><b>4201</b> polea cigueñal TurboD motor DK5ATE r.o. 0515.H3</p>
 <p><b>4052</b> horquilla embargue completa 2.0 gasolina r.o. 2115.25</p>	<p><b>¡Nuevo!</b></p>  <p><b>4799</b> horquilla embargue completa TurboD-DK5 r.o. 5117.59</p>	<p><b>¡Nuevo!</b></p>  <p><b>4605</b> casquillo guía embargue r.o. 2105.35</p>
 <p><b>1943</b> kit fuelle lado rueda hasta '93 r.o.</p>	 <p><b>1362</b> kit fuelle lado cambio hasta '93 r.o. 3293.59</p>	 <p><b>2305</b> kit fuelle lado rueda desde '93 r.o. 3293.96</p>
 <p><b>1839</b> kit fuelle lado cambio desde '93 r.o. 3287.79</p>	<p><b>¡Nuevo!</b></p>  <p><b>4564</b>      Ø 30/47 y 40/58 mm juego retenes diferencial-transmisión r.o. 3124.46+3121.44</p>	<p><b>¡Nuevo!</b></p>  <p><b>4620</b>      Ø 32/50 y 40/58 mm juego retenes diferencial-transmisión r.o. 3121.44+3121.24</p>

PEUGEOT 605



**1515**  
fuelie izquierdo cremallera dirección  
r.o.4066.42

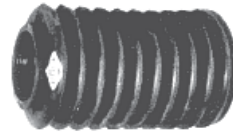

**1536**  
fuelie derecho cremallera dirección  
r.o.4066.30

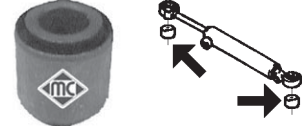

**2911**  
silentbloc pistón cremallera asistida  
r.o.4059.10 (12x24x20x24)



**844**  
capuchón derecho cremallera asistida  
r.o.4066.21



**3548**  
tapón botella de expansión  
r.o.1306.84-1306.C7

**¡nuevo!**



**4929**  
rodillo tensor correa alternador 2.0 con A/C  
r.o.5751.20

**¡nuevo!**



**4895**  
tensor correa alternador 2.0 con A/C  
r.o.5751.35

**¡nuevo!**



**4826**  
tensor correa alternador XUD con A/C  
A/C,r.o.5751.30

**¡nuevo!**



**4995**  
rodillo tensor correa alternador XUD  
con A/C,r.o.5751.29

**¡nuevo!**



**4609**  
tensor correa alternador XUD11 sin A/C  
r.o.5751.38

**¡nuevo!**



**4915** Ø 54,60 mm  
polea de alternador de rueda libre  
r.o.

**¡nuevo!**



**4916** Ø 58,50 mm  
polea de alternador de rueda libre  
r.o.



**2940** junta de Ø 80 x 66 mm  
kit montaje colector escape2.0-2.1D  
r.o.1798.75-1798.80



**084**  
soporte tubo de escape  
r.o.1755.59



**749**  
collarín escape  
r.o.



**2770**  
cubrepedal freno  
r.o.4504.12



**2771**  
cubrepedal embrague  
r.o.2130.13

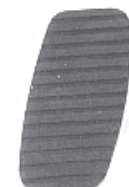

**2772**  
cubrepedal acelerador  
r.o.1604.07



**667**  
tapón de cárter 16x150 (todos hasta '96)  
r.o.93502063



**2452**  
tapón de cárter 14x125  
r.o.0311.21



**2024**  
arandela tapón de cárter con retén de goma  
r.o.



## CANALIZACIONES DE AGUA:

motores PSA 1.9 D (XUD9) y 1.9 TD (XUD9TE):

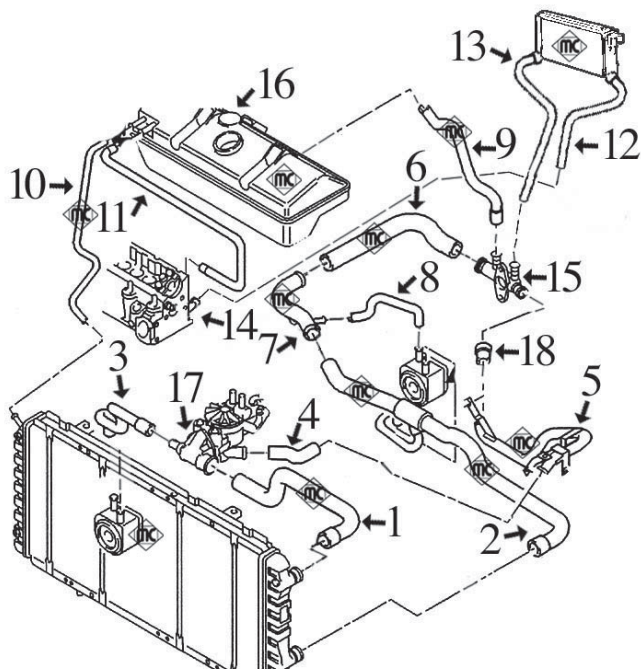

- 1- 8500 mgto superior radiador
- 2- 8502 mgto inferior radiador
- 3- 8506 mgto de tapa termostato a intercambiador
- 4- 8183 mgto de caja termostato a tubo hasta '98
- 8480 mgto de caja termostato a tubo desde '98
- 5- 3057 tubo de agua metálico
- 6- 8505 mgto de tubo metálico a racor plástico
- 7- 3131 tubo de agua metálico
- 8- 8501 mgto de intercambiador a tubo metálico
- 9- 8507 mgto de racor plástico a botella
- 10- 116 mgto de botella a radiador. Cortar de rollo MC-116  
Ø 8 x 15 mm longitud 720 mm
- 11- 8504 mgto de botella a culata
- 12- 8537 mgto de calefactor a culata
- 13- 8538 mgto de calefactor a racor plástico
- 14- 3059 boquilla en culata
- 15- 3503 racor plástico conexión mgts.
- 16- 3572 tapón botella expansión 1.0 bar
- 17- 3546 tapa de termostato
- 18- 8312 mgto de tubo metálico a racor plástico

motores PSA 2.0HDi (DW10TD) y 2.2HDi (DW12TED):

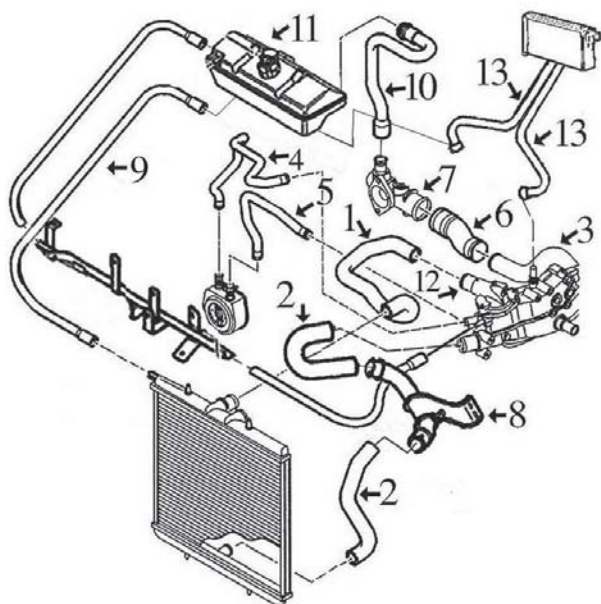

- 1- 8897 mgto superior radiador
- 2- 8898 mgto inferior radiador (2 tramos)
- 3- 3139 tubo de agua metálico 2.0HDi
- 3174 tubo de agua metálico 2.2HDi
- 4- 8554 mgto de intercambiador a caja termostato
- 5- 8586 mgto de intercambiador a caja termostato
- 6- 8587 mgto de tubo metálico a tapa bomba 2.0HDi
- 8950 mgto de tubo metálico a tapa bomba 2.2HDi
- 7- 3554 tapa bomba de agua conexión manguitos
- 8- 3169 tubo de agua metálico empalme mgto inferior
- 9- n/d mgto de botella a radiador
- 10- n/d mgto de botella a tapa bomba
- 11- 3572 tapón botella expansión
- 12- 3135 tapa de termostato
- 13- 8946 juego mgts de calefacción

8540 mgto desvaporizador



## PEUGEOT BOXER

**motores SOFIM 2.5 D (DJ5) y 2.5 TurboD (DJ5T) hasta '97:**

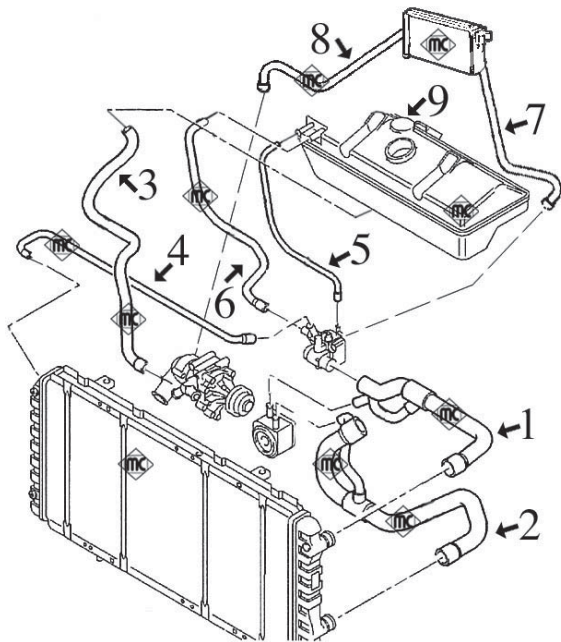

- 1- 8495 mgto superior radiador
- 2- 8496 mgto inferior radiador 2.5 Diesel  
8498 mgto inferior radiador 2.5 TurboD
- 3- 8497 mgto de bomba agua a botella
- 4- 8499 mgto de caja termostato a radiador
- 5- 116 mgto de botella a caja termostato. Cortar de rolo MC-116 Ø 8 x 15 mm longitud 950 mm
- 6- 8503 mgto de botella a caja termostato
- 7- 8508 mgto de calefactor a caja termostato
- 8- 8509 mgto de calefactor a bomba de agua
- 9- 3572 tapón botella expansión 1.0 bar

**motores SOFIM 2.5 TurboD (DJ5T) desde '97:**

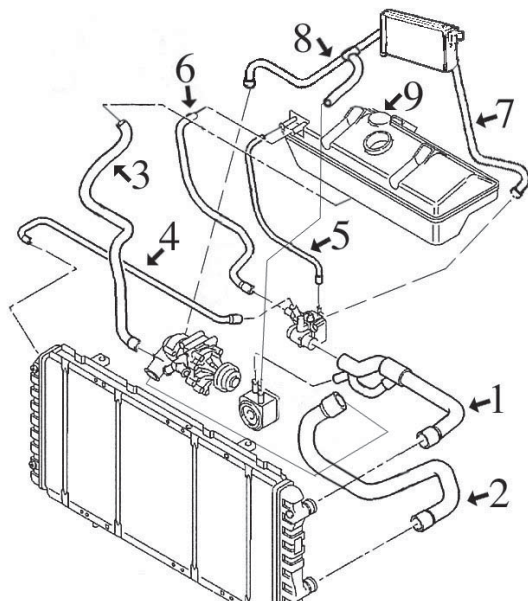

- 1- 8495 mgto superior radiador
- 2- 8901 mgto inferior radiador
- 3- 8497 mgto de bomba agua a botella
- 4- 8499 mgto de caja termostato a radiador
- 5- 116 mgto de botella a caja termostato. Cortar de rolo MC-116 Ø 8 x 15 mm longitud 950 mm
- 6- 8503 mgto de botella a caja termostato
- 7- 8932 mgto de calefactor a caja termostato
- 8- 8929 mgto de calefactor a bomba agua e intercambiador
- 9- 3572 tapón botella expansión 1.0 bar

## PEUGEOT BOXER

motores SOFIM 2.8 - 2.8TD y 2.8HDi:

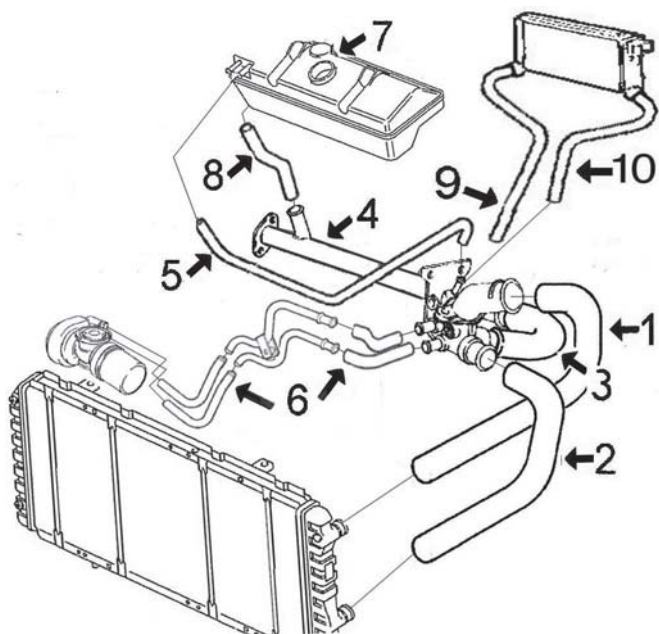

- 1- 8842 mgto superior radiador
- 2- 8843 mgto inferior radiador
- 3- 8832 mgto de caja termostato a tubo metálico
- 4- 3124 tubo de agua metálico
- 5- 117 mgto de caja termostato a botella: cortar de rollo MC-117 Ø 10x17 mm long. 420 mm
- 6- 8835 juego 4 mgto de caja termostato a tubos metálicos y de tubos a intercambiador
- 7- 3572 tapón botella de expansión
- 8- 843 mgto de tubo metálico a botella: cortar de rollo MC-843 Ø 19x25 mm long. 420 mm
- 9- 8840 mgto de calefactor a culata
- 10- 8841 mgto de calefactor a caja termostato



mgto. DESVAPORIZADORES 1.9 Diesel (XUD9) y TurboD (XUD9TE)  
(motores PSA)

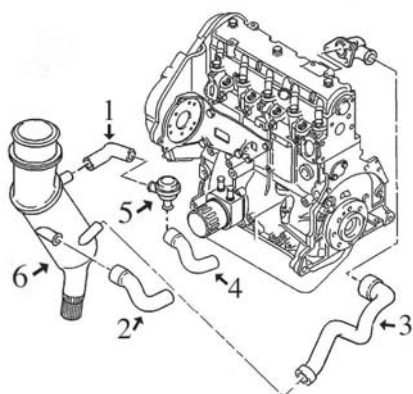

- 1- 8167 mgto de decantador a regulador motor 1.9 Diesel
- 8492 mgto de decantador a regulador motor 1.9 TurboD
- 2- 8166 mgto de cárter a decantador motores D+TD
- 3- 8494 mgto de decantador a culata D+TD
- 4- 8493 mgto de regulador a filtro aire TD
- 5- 3637 válvula desvaporizadora
- 6- 3666 decantador completo con tapón y junta tórica

## PEUGEOT BOXER



**8183**

mgto de caja termostato a tubo 1.9D h/'98  
r.o. 1307.W3



**8312**

mgto de tubo metálico a racor plástico  
r.o. 1307.W4



**8480**

mgto de caja termostato a tubo desde '98  
r.o.



**8495**

mgto superior radiador 2.5 D-TD  
r.o.



**8496**

mgto inferior radiador 2.5 D  
r.o.



**8497**

mgto de botella a bomba agua  
r.o.



**8498**

mgto inferior radiador 2.5 TurboD  
r.o.



**8499**

mgto de caja termostato a radiador  
r.o.



**8500**

mgto superior radiador 1.9 D-TD  
r.o.



**8501**

mgto de intercambiador a tubo metálico 1.9  
r.o.



**8502**

mgto inferior radiador 1.9 D-TD  
r.o.



**8503**

mgto de botella a caja termostato 2.5  
r.o.



**8504**

mgto de botella a culata 1.9 D-TD  
r.o.



**8505**

mgto de tubo metálico a racor plástico 1.9  
r.o.



**8506**

mgto de caja termostato a intercambiador  
r.o.



**8507**

mgto de racor plástico a botella 1.9  
r.o.



**8508**

mgto de calefactor a caja termostato 2.5  
r.o.



**8509**

mgto de calefactor a bomba agua 2.5  
r.o.



**8537**

mgto de calefactor a culata 1.9  
r.o.



**8538**

mgto de calefactor a racor plástico 1.9  
r.o.



**8554**

mgto de intercambiador 2.0-2.2 HDi  
r.o.

## PEUGEOT BOXER



**8586**  
mgto de intercambiador 2.0-2.2HDI  
r.o.



**8587**  
mgto de tubo a tapa de plàstico 2.0HDI  
r.o.



**8832**  
mgto de caja termostato a tubo 2.8HDI  
r.o.



**8835**  
jgo mgto intercambiador a caja 2.8HDI  
r.o.



**8840**  
mgto de calefactor a culata 2.8HDI  
r.o.



**8841**  
mgto de calefactor a caja termost. 2.8HDI  
r.o.



**8842**  
mgto superior radiador 2.8HDI  
r.o.



**8843**  
mgto inferior radiador 2.8HDI  
r.o.



**8897**  
mgto sup radiador 2.0-2.2HDI  
r.o.



**8898**  
mgto inferior radiador 2.0-2.2HDI (2 tramos)  
r.o.



**8901**  
mgto inferior radiador 2.5 TD desde '97  
r.o.



**8932**  
mgto calefactor a caja termostato 2.5TD  
r.o.



**8929**  
mgto de calefactor a bomba 2.5TD desde '97  
r.o.



**8946**  
jgo mgto calefactor 2.0-2.2HDI  
r.o.



**8950**  
mgto de tubo a tapa de plàstico 2.2HDI  
r.o.



## PEUGEOT BOXER

 <p><b>8166</b> mgto desvaporizador 1.9 D y TD r.o. 1192.48</p>	 <p><b>8167</b> mgto desvaporizador 1.9 D r.o. 1180.A3</p>	 <p><b>8492</b> mgto desvaporizador 1.9 TD r.o.</p>
 <p><b>8493</b> mgto desvaporizador 1.9 D y TD r.o.</p>	 <p><b>8494</b> mgto desvaporizador 1.9 TD r.o.</p>	 <p><b>8540</b> mgto desvaporizador 2.0HDi-2.2HDi r.o.</p>
 <p><b>3057</b> tubo de agua metálico 1.9 D-TD r.o. 1307.W2</p>	 <p><b>3059</b> boquilla en culata 1.9 D-TD r.o. 0245.42-0245.44</p>	 <p><b>3124</b> tubo de agua metálico 2.8HDi r.o.</p>
 <p><b>3131</b> tubo de agua metálico 1.9 D-TD r.o.</p>	 <p><b>3135</b> tapa de termostato 2.0-2.2HDi r.o.</p>	 <p><b>3139</b> tubo de agua metálico 2.0HDi r.o.</p>
 <p><b>3169</b> tubo de empalme mgto inferior 2.0-2.2HDi r.o. 1307.XX</p>	 <p><b>3174</b> tubo de agua metálico 2.2HDi con junta r.o. 1307.SJ</p>	 <p><b>3503</b> racor plástico conexión mgto 1.9 D-TD r.o. 1336.G4</p>
 <p><b>3523</b> racor plástico conexión mgto 2.0 gasolina r.o. 1336.H7</p>	 <p><b>3546</b> tapa de termostato 1.9 D - TD r.o. 1336.G3</p>	 <p><b>3554</b> racor plástico conexión mgto 2.0-2.2HDi r.o. 1336.P5</p>
 <p><b>3572</b> tapón botella expansión 1.0 bar r.o. 1306.E1</p>	 <p><b>3637</b> válvula desvaporizadora 1.9D XUD9 r.o. 0361.58</p>	 <p><b>3666</b> decantador completo con tapón y junta 1.9D(XUD9),r.o. 1180.C0+1170.I7</p>

## PEUGEOT BOXER

### SUSPENSION DELANTERA y SOPORTES DE MOTOR HASTA -2001 (X23F):

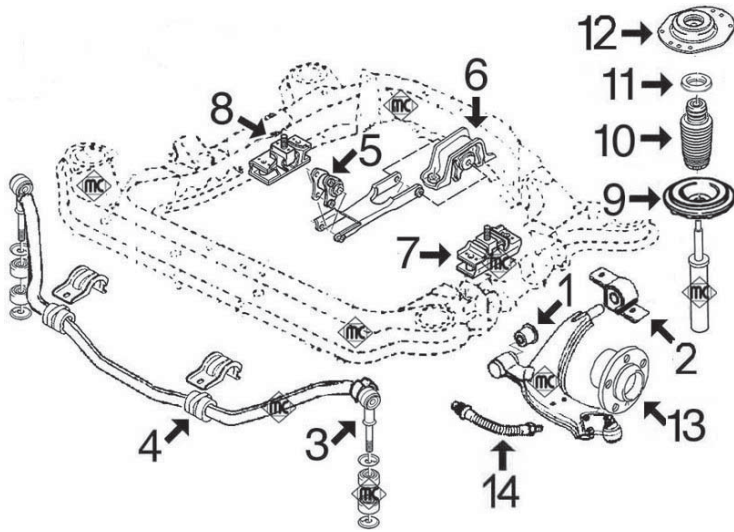

- 1- 2872 silentbloc anterior trapecio delantero
- 2- 2873 silentbloc posterior trapecio delantero
- 3- 2956 bieleta puntal barra estabilizadora completa
- 4- n/d goma barra estabilizadora
- 5- 2985 silentbloc tirante posterior motor
- 6- 2984 soporte motor trasero
- 7- 2987 soporte motor izquierdo 2.0-1.9D-2.5D-2.8D  
4565 soporte motor izquierdo 2.0HDi-2.2HDi-2.8HDi
- 8- 2986 soporte motor derecho 2.0-1.9D-2.5D-2.8D  
4565 soporte motor derecho 2.0HDi-2.2HDi-2.8HDi
- 9- 4446 soporte superior muelle delantero
- 10- 4616 capuchón con tope amortiguador 1.000/1.400 Kg.  
4617 capuchón con tope amortiguador 1.800 Kg.
- 11- 4182 rodamiento soporte amortiguador delantero
- 12- 2918 soporte amortiguador izquierdo  
2925 soporte amortiguador derecho
- 13- 90039 buje de rueda delantera 1.000-1.400 Kg.  
90040 buje de rueda delantera 1.800 Kg.
- 14- 96102 latiguillo freno delantero (490 mm)

### SUSPENSION DELANTERA y SOPORTES DE MOTOR DESDE 2001- (U5F):

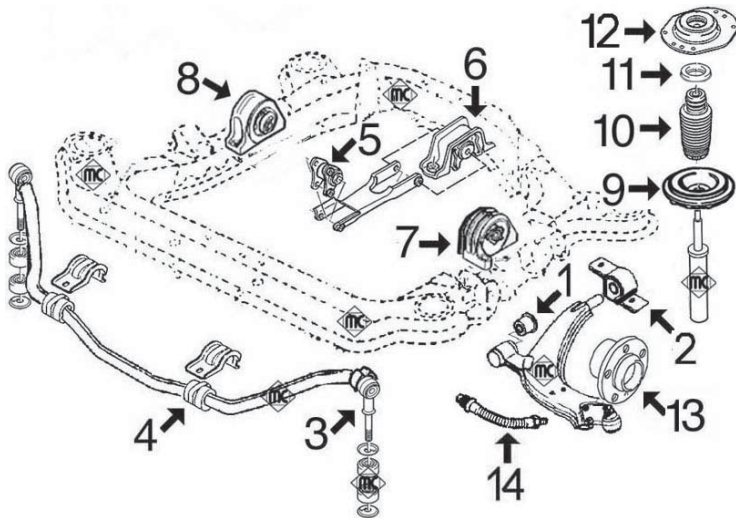

- 1- 2872 silentbloc anterior trapecio delantero
- 2- 2873 silentbloc posterior trapecio delantero
- 3- 2956 bieleta puntal barra estabilizadora completa
- 4- n/d goma barra estabilizadora
- 5- 2985 silentbloc tirante posterior motor
- 6- 2984 soporte motor trasero
- 7- 4566 soporte motor izquierdo
- 8- 4567 soporte motor derecho
- 9- 4446 soporte superior muelle delantero
- 10- 4616 capuchón con tope amortiguador 1.000/1.400 Kg.  
4617 capuchón con tope amortiguador 1.800 Kg.
- 11- 4182 rodamiento soporte amortiguador delantero
- 12- 4570 soporte amortiguador izquierdo  
4571 soporte amortiguador derecho
- 13- 90039 buje de rueda delantera 1.000-1.400 Kg.  
90040 buje de rueda delantera 1.800 Kg.
- 14- 96102 latiguillo freno delantero (490 mm)

### SUSPENSION TRASERA:

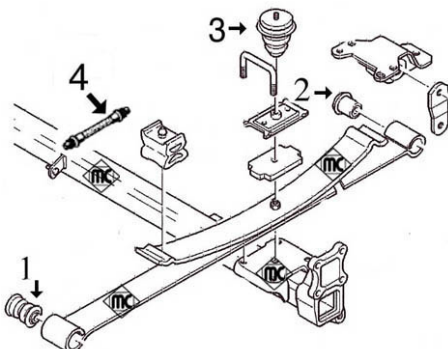

- 1- 2954 silentbloc anterior ballesta
- 2- 2955 silentbloc posterior ballesta
- 3- 2957 tope poliuretano
- 4- 96145 latiguillo freno trasero (360 mm)

## PEUGEOT BOXER

 <p><b>2872</b> silentbloc anterior trapezio delantero r.o.</p>	 <p><b>2873</b> silentbloc posterior trapezio delantero r.o.</p>	 <p><b>2918</b> soporte amortiguador izquierdo r.o.5038.18-5038.41</p>
 <p><b>2925</b> soporte amortiguador derecho r.o. 5038.19-5038.42</p>	 <p><b>2954</b> silentbloc anterior ballesta trasera r.o.5131.73</p>	 <p><b>2955</b> silentbloc posterior ballesta trasera r.o.5131.72</p>
 <p><b>2956</b> bieleta puntal barra estabilizadora completa r.o.5087.37+5093.15</p>	 <p><b>2957</b> tope poliuretano suspensión posterior r.o.</p>	 <p><b>2984</b> soporte motor trasero r.o.1846.66</p>
 <p><b>2985</b> silentbloc tirante posterior motor r.o.1846.65</p>	 <p><b>2986</b> soporte motor derecho r.o.1844.46</p>	 <p><b>2987</b> soporte motor izquierdo r.o.1827.17-1827.18</p>
 <p><b>4182</b> rodamiento soporte suspensión r.o.5035.47</p>	 <p><b>4446</b> soporte superior muelle suspensión delant. r.o.5031.40-5031.75</p>	 <p><b>4565</b> soporte motor 2.0-2.0HDi-2.8HDi hasta '01 r.o.1807.R5-1801.39-1839.A0-1802.53</p>
 <p><b>4566</b> soporte motor izqdo. todos tipos desde '01 r.o.1801.T1-1807.S9-1807.S7</p>	 <p><b>4567</b> soporte motor dcho. todos tipos desde '01 r.o.1839.A6-1802.56-1839.AT</p>	 <p><b>4570</b> soporte dcho. amortiguador delt. desde '01 r.o.5038.87-5038.72</p>
 <p><b>4571</b> soporte izqdo. amortiguador delt. desde '01 r.o.5038.89</p>	 <p><b>4616</b> capuchón con tope amortg. delt. 1.000-1.400 kgs, r.o. 5033.41</p>	 <p><b>4617</b> capuchón con tope amortg. delt. 1.800 kgs. r.o.5033.42</p>



## PEUGEOT BOXER

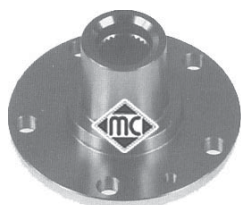

**90039**

buje de rueda delantera 1.000-1.400 Kgs.  
r.o. 3307.65



**90040**

buje de rueda delantera 1.800 Kgs.  
r.o. 3307.66



**96102**

latiguillo freno delantero (490 mm)  
r.o. 480671



**96145**

latiguillo freno trasero (360 mm)  
r.o. 480672-480673-481636

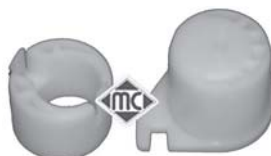

**4043**

juego casquillos horquilla embrg. 1.9D-TD  
r.o. 2175.20+2175.21



**4052**

horquilla embrague completa  
2.0XU y 1.9Diesel y TD, r.o. 2115.25

**¡Nuevo!**



**4601**

horquilla embrague 2.0 HDi  
r.o. 2117.66-2117.57

**¡Nuevo!**



**4554**

pedal embrague completo con muelle retorno  
r.o. 2127.A4+2148.31



**2926**

polea cigueñal 1.9 D-TD hasta '97  
r.o. 0515.G3



**4202**

polea cigueñal 1.9 D-TD desde '97  
r.o. 0515.K4

**¡Nuevo!**



**4201**

polea cigueñal 2.5 D-TD  
r.o. 0515.H3



**2928**

Ø162 mm 6 canales  
polea cigueñal 2.0 HDi (hasta 5/'04)-2.2 HDi  
sin aire ac., r.o. 0515.P2

**¡Nuevo!**



**4798**

Ø158 mm 6 canales  
polea cigueñal 2.0 HDi (desde 5/'04)-2.2 HDi  
con aire ac., r.o. 0515.S8

**¡Nuevo!**



**4568**

polea cigueñal 2.8D-TD-2.8 HDi  
r.o. 0515.P3-0515.P9-0515.N2



**4197**

cardán dirección cremallera manual  
r.o. 4103.E6



**1820**

fuelle cremallera dirección  
r.o. 4006.22



**1225**

kit rep. transmisión l/rda. 1.000-1400 Kg.  
r.o. 3293.98



**2307**

kit rep. transmisión l/rda. 1.800 Kg.  
hasta '96, r.o. 3293.99



**1391**

kit rep. transmisión l/rda. 1.800 Kg. desde  
'96, r.o. 3293.07



**1362**

kit rep. transmisión l/cbo. "1.000 Kg."  
r.o. 3287.90











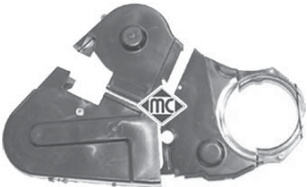

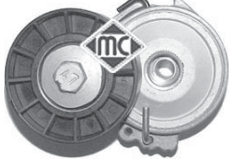





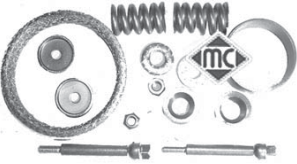
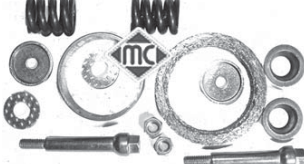

**1407**

kit rep. transmisión l/cbo. "1.800 Kg."  
r.o. 3287.78



## PEUGEOT BOXER

<p><b>¡Nuevo!</b></p>  <p><b>3698</b> juego tapas correa distribución 1.9XUD r.o. 0320.H2/H3/F9</p>	<p><b>¡Nuevo!</b></p>  <p><b>3699</b> juego tapas correa distribución 2.0HDI r.o. 0320.N5/N6/S7</p>	<p><b>¡Nuevo!</b></p>  <p><b>4807</b> tensor correa alternador 2.0HDI sin a/c r.o. 5751.30</p>
<p><b>¡Nuevo!</b></p>  <p><b>5043</b> tensor correa alternador 2.0/2.2HDI desde '04 r.o. 5751.74</p>	<p><b>¡Nuevo!</b></p>  <p><b>4620</b>      <math>\text{\O} 32/50</math> y <math>\text{\O} 40/58</math> mm juego retenes diferencial-transmisión r.o. 3121.24+3121.44</p>	<p><b>¡Nuevo!</b></p>  <p><b>3642</b> tapón llenado aceite 2.0HDI-2.2HDI r.o. 1180.F9</p>
<p><b>¡Nuevo!</b></p>  <p><b>4995</b> rodillo tensor correa alternador 2.0HDI r.o. 5751.29</p>	<p><b>¡Nuevo!</b></p>  <p><b>4915</b>      <math>\text{\O} 54,60</math> mm polea de alternador de rueda libre r.o.</p>	<p><b>¡Nuevo!</b></p>  <p><b>4916</b>      <math>\text{\O} 58,50</math> mm polea de alternador de rueda libre r.o.</p>
<p><b>¡Nuevo!</b></p>  <p><b>4479</b> soporte tapa motor HDI r.o. 0137.11</p>	<p><b>¡Nuevo!</b></p>  <p><b>2392</b>      junta de <math>\text{\O} 60 \times 46</math> mm kit montaje colector escape 1.9 Diesel r.o. 1798.76</p>	<p><b>¡Nuevo!</b></p>  <p><b>2940</b>      junta de <math>\text{\O} 80 \times 66</math> mm kit montaje colector escape 1.9 TD y 2.5 r.o. 1798.80-1798.75</p>
<p><b>¡Nuevo!</b></p>  <p><b>4598</b>      junta de <math>\text{\O} 80 \times 66</math> mm kit montaje colector escape 2.0HDI-2.2HDI- 2.8HDI-Sofim 2.5TD, r.o.</p>	<p><b>¡Nuevo!</b></p>  <p><b>4599</b>      junta de <math>\text{\O} 60 \times 46</math> mm kit montaje colector escape Sofim 2.5D- 2.8TD, r.o.</p>	<p><b>¡Nuevo!</b></p>  <p><b>366</b> soporte tubo de escape (32x59 mm) r.o. 1755.60</p>
<p><b>¡Nuevo!</b></p>  <p><b>4010</b> soporte tubo escape 2.0HDI-2.2HDI r.o. 1755.68</p>	<p><b>¡Nuevo!</b></p>  <p><b>2638</b> soporte tubo de escape r.o. 1755.65</p>	<p><b>¡Nuevo!</b></p>  <p><b>2452</b> tapón cárter aceite 14 x 125 r.o. 0311.21</p>
<p><b>¡Nuevo!</b></p>  <p><b>667</b> tapón cárter aceite 16 x 150 r.o. 0163.88</p>		

CANALIZACIONES DE AGUA:

mgts. motor 1.9 D (XUD) y 1.9 TD (XUDTE) (hasta '99)

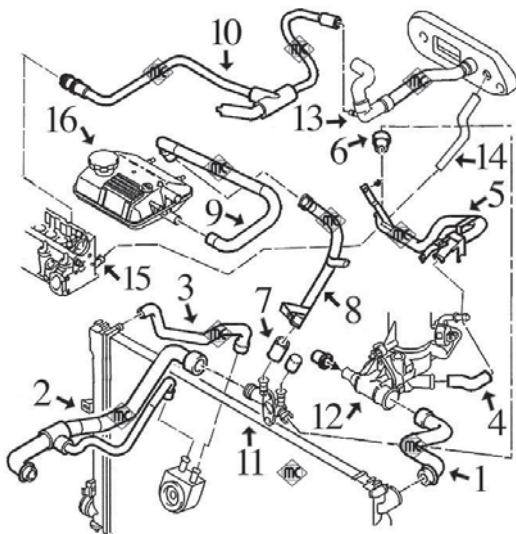

- 1- 8484 mgto superior radiador
- 2- 8483 mgto inferior radiador
- 3- 8489 mgto de radiador a intercambiador
- 4- 8183 mgto de caja termostato a tubo hasta '98  
8480 mgto de caja termostato a tubo desde '98
- 5- 3057 tubo de agua metálico
- 6- 8312 mgto de tubo metálico a racor plástico
- 7- 8488 mgto de racor plástico a tubo metálico
- 8- 3130 tubo metálico de racor plástico a botella
- 9- 8487 mgto de tubo metálico a botella
- 10- 8490 mgto de tubo de calefacción a culata, TurboDiesel
- 11- 3503 racor plástico conexión mgts.
- 12- 3546 tapa de termostato  
3171 boquilla metálica en caja de termostato
- 13- 8485 mgto dcho. calefactor
- 14- 8486 mgto izqdo. calefactor
- 15- 3059 boquilla en culata
- 16- 3741 botella de expansión  
3547 tapón botella expansión 1.0 bar

mgts. motor 1.9DW8 (desde '99)

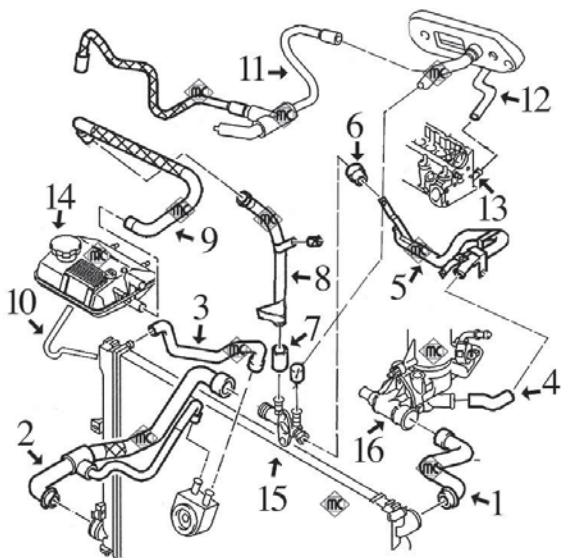

- 1- 8564 mgto superior radiador
- 2- 8557 mgto inferior radiador
- 3- 8556 mgto de radiador a intercambiador hasta '00  
8558 mgto de radiador a intercambiador desde '00
- 4- 8480 mgto de caja termostato a tubo
- 5- 3129 tubo de agua metálico
- 6- 8312 mgto de tubo metálico a racor plástico
- 7- 8488 mgto de racor plástico a tubo metálico hasta '00
- 8- 3138 tubo metálico de racor plástico a botella hasta '00
- 9- 8561 mgto de tubo metálico a botella hasta '00  
8562 mgto de tubo metálico a botella desde '00
- 10- 8563 mgto de botella a radiador
- 11- 8559 mgto de calefactor a botella
- 12- 8560 mgto de calefactor a culata
- 13- 3059 boquilla en culata
- 14- 3741 botella de expansión hasta 6/'00  
3742 botella de expansión desde 6/'00  
3547 tapón botella expansión 1.0 bar
- 15- 3544 racor plástico conexión manguitos
- 16- 3539 tapa de termostato  
3171 boquilla metálica en caja de termostato

mgts. motor 2.0 HDi

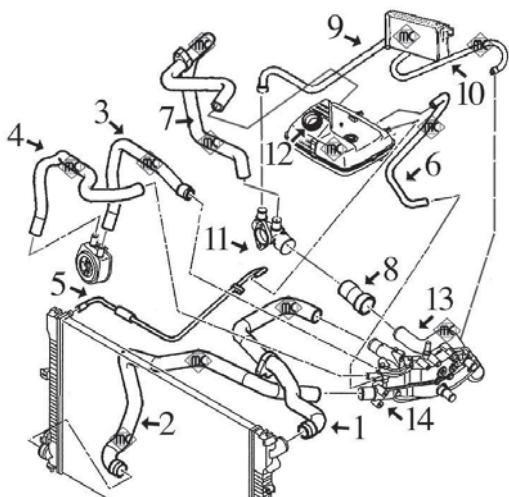

- 1- 8598 mgto superior radiador
- 2- 8597 mgto inferior radiador
- 3- 8585 mgto de intercambiador a caja termostato
- 4- 8596 mgto de intercambiador a caja termostato
- 5- 8592 mgto de botella a radiador
- 6- 8591 mgto de botella a caja termostato
- 7- 8595 mgto de racor plástico a botella
- 8- 8587 mgto de tubo metálico a racor plástico
- 9- 8593 mgto derecho calefactor
- 10- 8594 mgto izquierdo calefactor
- 11- 3554 racor plástico conexión manguitos
- 12- 3742 botella de expansión  
3547 tapón botella expansión 1.0 bar
- 13- 3139 tubo metálico con junta tórica
- 14- 3135 tapa de termostato (aluminio)  
3556 tapa de termostato (plástico)

PEUGEOT EXPERT - 806 - 807



**8183**

mgto de caja termostato a tubo 1.9D h/'98  
r.o. 1307.W3



**8312**

mgto de tubo metálico a racor plástico  
r.o. 1307.W4



**8480**

mgto de caja termostato a tubo  
r.o.



**8483**

mgto inferior radiador 1.9 D  
r.o.



**8484**

mgto superior radiador 1.9 D  
r.o.



**8485**

mgto derecho calefactor 1.9 D  
r.o.



**8486**

mgto izquierdo calefactor 1.9 D  
r.o.



**8487**

mgto de tubo metálico a botella  
r.o.



**8488**

mgto de racor plástico a tubo metálico  
r.o.



**8489**

mgto de radiador a intercambiador  
r.o.



**8490**

mgto de tubo calefacción a culata 1.9 TD  
r.o.



**8556**

mgto de radiador a intercambiador  
r.o.



**8557**

mgto inferior radiador 1.9 DW8  
r.o.



**8558**

mgto de radiador a intercambiador  
r.o.



**8559**

mgto de calefactor a botella  
r.o.



**8560**

mgto de calefactor a culata  
r.o.



**8561**

mgto de tubo metálico a botella  
r.o.



**8562**

mgto de tubo metálico a botella  
r.o.



**8563**

mgto de botella a radiador  
r.o.



**8564**

mgto superior radiador 1.9 DW8  
r.o.



**8585**

mgto de intercambiador 2.0 HDi  
r.o.



PEUGEOT EXPERT - 806 - 807



**8587**  
mgto de tubo metálico a racor plástico HDi  
r.o.



**8591**  
mgto de botella a caja termostato HDi  
r.o.



**8592**  
mgto de botella a radiador HDi  
r.o.



**8593**  
mgto derecho calefactor HDi  
r.o.



**8594**  
mgto izquierdo calefactor HDi  
r.o.



**8595**  
mgto de botella a racor plástico  
r.o.



**8596**  
mgto de intercambiador a caja termostato  
r.o.



**8597**  
mgto inferior radiador 2.0 HDi  
r.o.



**8598**  
mgto superior radiador 2.0 HDi  
r.o.



**3057**  
tubo de agua metálico 1.9 D y TD  
r.o. 1307.W2



**3059**  
boquilla en culata 1.9 Diesel todos  
r.o. 0245.42-0245.44



**3078**  
boquilla en caja termostato 1.8 gasolina  
r.o. 1336.K8



**3129**  
tubo de agua metálico 1.9 DW8  
r.o.



**3130**  
tubo de agua metálico a botella 1.9 D  
r.o.



**3135**  
tapa de termostato 2.0 HDi (aluminio)  
r.o.



**3138**  
tubo de agua metálico 1.9 DW8  
r.o.



**3139**  
tubo de agua metálico 2.0 HDi con junta  
r.o.



**3171**  
boquilla en caja termostato 1.9D-TD (XU)  
r.o. 1336.N7



**3503**  
racor conexión mgto 1.9 Diesel hasta '99  
r.o. 1336.G4

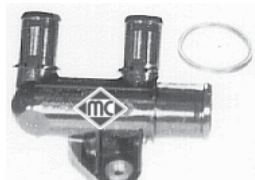

**3523**  
racor conexión mgto 1.8 gasolina  
r.o. 1336.H7



**3538**  
tapa de termostato 1.8 gasolina (XU7)  
r.o. 1336.A1



PEUGEOT EXPERT - 806 - 807



**3539**  
tapa de termostato 1.9 DW8  
r.o. 1336.C9



**3544**  
racor conexión mgts 1.9 Diesel DW8  
r.o. 1336.P0-1336.Q3



**3546**  
tapa de termostato 1.9 Diesel  
r.o. 1336.G3



**3547**  
tapón botella expansión 1.0 bar  
r.o. 1336.E0-1336.C6



**3554**  
racor conexión mgts 2.0 HDi  
r.o.



**3556**  
tapa de termostato 2.0 HDi (plástico)  
r.o. 1336.R9

**¡nuevo!**



**3741**  
botella de expansión 1.6-1.8 gasolina y 1.9D  
hasta 6/00, r.o. 1307.RH-1307.RJ

**¡nuevo!**



**3742**  
botella de expansión 1.9D desde 6/00, 2.0  
gasolina y 2.0 HDi, r.o. 1307.ST

mgtos. DESVAPORIZADORES 1.9 Diesel-XUD9 y XUD9TE:

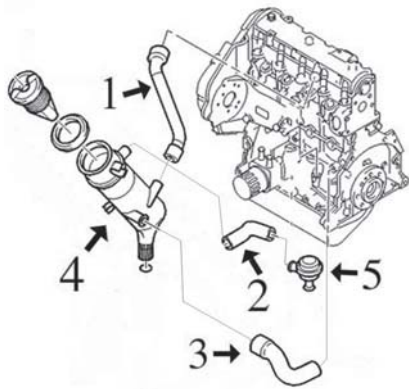

- 1- 8307 mgto de tapa balancines a decantador motores XUD
- 2- 8167 mgto de decantador a válvula motor 1.9D-XUD
- 3- 8166 mgto de bloque a decantador motor 1.9D-XUD9
- 8491 mgto de bloque a decantador motor 1.9TD-XUD9TE
- 4- 3631 decantador completo con tapón 1.9D-XUD
- 5- 3637 válvula desvaporizadora 1.9D-XUD

mgtos. DESVAPORIZADORES 1.9 Diesel DW8:

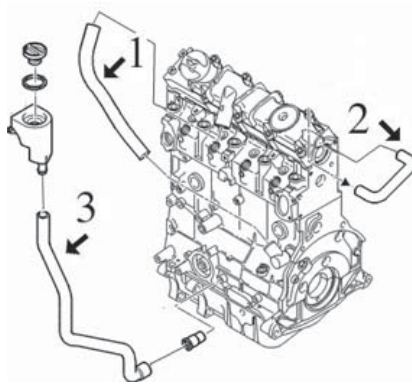

- 1- 8474 mgto de tapa balancines a colector motor 1.9 DW8
- 2- 8475 mgto de bloque a culata motor 1.9 DW8
- 3- n/d mgto de cárter a regulador



**8166**  
mgto desvaporizador 1.9 D y TD  
r.o. 1192.48



**8167**  
mgto desvaporizador 1.9 D y TD  
r.o. 1180.A3



**8307**  
mgto desvaporizador 1.9 D y TD  
r.o. 1180.86



**8474**  
mgto desvaporizador 1.9DW8  
r.o. 1180.G4



**8475**  
mgto desvaporizador 1.9DW8  
r.o. 1180.G5



**8491**  
mgto desvaporizador 1.9 TD (XUDTE)  
r.o.



**3631**  
decantador completo con tapón  
r.o. 1180.95



**3637**  
válvula desvaporizadora 1.9D-TD  
(motores XUD), r.o. 0361.58



**4490**  
soporte decantador motor 1.8 XU7  
r.o. 1439.10

**SUSPENSION DELANTERA y SOPORTES DE MOTOR**  
**MOTORES DE GASOLINA 1.6 (FIAT 1580 SPi) - 1.8 (PSA-XU7) y 2.0 (PSA-EW10)**

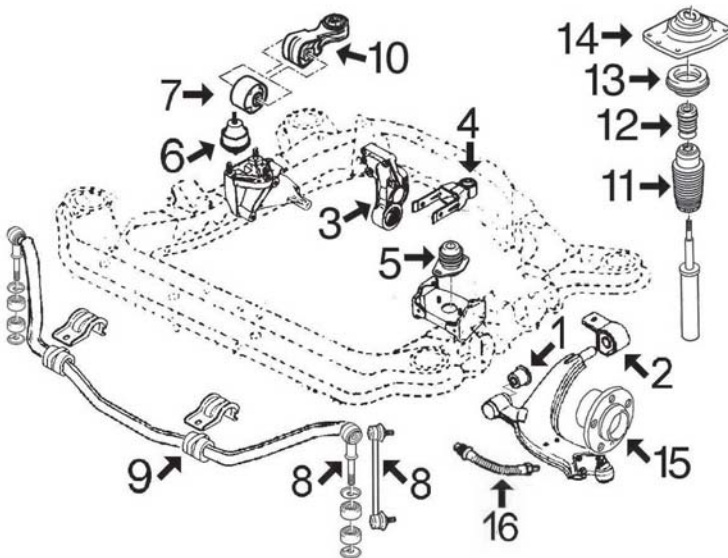

- 1- 2981 silentbloc anterior trapecio delantero
- 2- 2982 silentbloc posterior trapecio delantero izquierdo
- 2983 silentbloc posterior trapecio delantero derecho
- 3- 2869 silentbloc soporte posterior motor 1.6-1.8
- 2966 silentbloc soporte posterior motor 2.0
- 4- 4744 tirante trasero de motor completo
- 877 silentbloc en tirante posterior de motor
- 5- 2794 soporte izquierdo motor, cambio manual
- 2943 soporte izquierdo motor, cambio automático
- 6- 2924 soporte derecho motor 1.6-1.8
- 2942 soporte derecho motor 2.0
- 7- 2869 silentbloc soporte bieleta antipar
- 8- 2948 bieleta puntal barra Expert y 806 todos
- 5055 bieleta puntal barra 807
- 9- 2945 goma soporte barra estabilizadora
- 10- 4744 bieleta antipar 1.8 (XU7)
- 4486 bieleta antipar 2.0 (EW10)
- n/d bieleta antipar 1.6
- 11- 4196 capuchón amortiguador delantero
- 12- n/d tope poliuretano
- 13- 4206 rodamiento
- 14- 2947 soporte amortiguador izquierdo, dirección asistida
- soporte amortiguador derecho, dirección manual
- 2946 soporte amortiguador derecho, dirección asistida
- soporte amortiguador izquierdo, dirección manual
- 15- 90038 buje rueda delantera
- 16- 96032 latiguillo freno delantero (515 mm)

**SUSPENSION DELANTERA y SOPORTES DE MOTOR**  
**MOTORES DIESEL 1.9 D (XUD y DW8) y 2.0 HDi (DW10)**

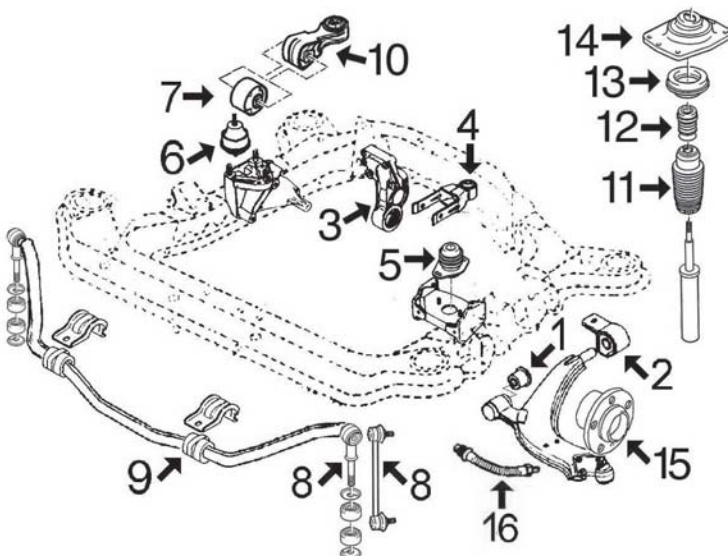

- 1- 2981 silentbloc anterior trapecio delantero
- 2- 2982 silentbloc posterior trapecio delantero izquierdo
- 2983 silentbloc posterior trapecio delantero derecho
- 3- 2980 silentbloc soporte posterior motor 1.9 Diesel-XUD,
- 1.9 Diesel-DW8
- 2966 silentbloc soporte posterior motor 2.0 HDi
- 4- 4744 tirante trasero de motor completo
- 877 silentbloc en tirante posterior de motor
- 5- 2794 soporte izquierdo motor 1.9 Diesel XUD y DW8
- 2943 soporte izquierdo motor 2.0 HDi
- 6- 2924 soporte derecho motor 1.9 Diesel-XUD
- 2942 soporte derecho motor 1.9 Diesel-DW8
- 2944 soporte derecho motor 2.0 HDi
- 7- 2869 silentbloc soporte bieleta antipar hasta 6/'01
- (desde 6/'01 incorporado en bieleta MC-4005)
- 8- 2948 bieleta puntal barra Expert y 806 todos
- 5055 bieleta puntal barra 807
- 9- 2945 goma soporte barra estabilizadora
- 10- 4744 bieleta antipar 1.9D-TD-DW8 y 2.0 HDi hasta 6/'01
- 4005 bieleta antipar 1.9DW8 y 2.0 HDi desde 6/'01
- 11- 4196 capuchón amortiguador delantero
- 12- n/d tope poliuretano
- 13- 4206 rodamiento
- 14- 2947 soporte amortiguador izquierdo, dirección asistida
- soporte amortiguador derecho, dirección manual
- 2946 soporte amortiguador derecho, dirección asistida
- soporte amortiguador izquierdo, dirección manual
- 15- 90038 buje rueda delantera
- 16- 96032 latiguillo freno delantero (515 mm)

PEUGEOT EXPERT - 806 - 807

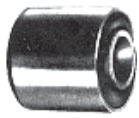

**877**  
silentbloc tirante posterior motor  
r.o.1809.04(12x30x28x34)



**2794**  
soporte izquierdo motor  
r.o.1844.36-1827.10

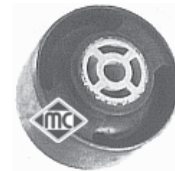

**2869**  
silentbloc soporte trasero motor  
r.o.1809.16



**2924**  
soporte motor derecho 1.6-1.8 y 1.9D  
r.o.1827.14-1827.26



**2942**  
soporte motor derecho 2.0 gasolina y 1.9DW  
r.o.1844.92



**2943**  
soporte motor izquierdo 2.0 HDi y automat.  
r.o.1827.16



**2944**  
soporte motor derecho 2.0 HDi  
r.o.1827.33



**2945**  
goma barra estabilizadora  
r.o.5094.69



**2946**  
soporte amortiguador Dcho-Izqdo.  
r.o.5038.17



**2947**  
soporte amortiguador Dcho-Izqdo.  
r.o.5038.16

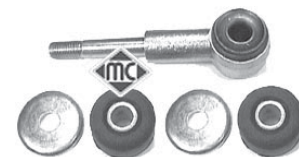

**2948**  
bieleta puntal barra estabilizadora completa  
Expert y 806, r.o.5087.35



**2949**  
silentbloc **brazo trasero** de suspensión  
r.o.5152.61(12x46x48x60)



**2966**  
silentbloc soporte motor trasero 2.0 HDi  
r.o.1809.30



**2980**  
silentbloc soporte motor trasero 1.9 D  
r.o.1809.21



**2981**  
silentbloc anterior trapecio delantero  
r.o. no hay despiece



**2982**  
silentbloc posterior trapecio delt. izquierdo  
r.o. no hay despiece



**2983**  
silentbloc posterior trapecio delt. derecho  
r.o. no hay despiece



**4005**  
bieleta tirante derecho motor (antipar)  
r.o.1806.28



















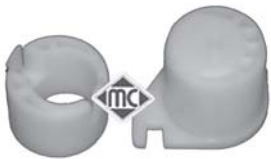



**4196**  
capuchón amortiguador delantero  
r.o.5254.19





















**4206**  
rodamiento en soporte amortiguador  
r.o.5035.43

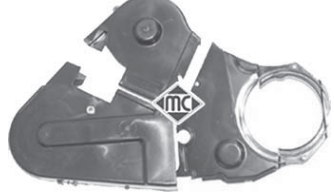

PEUGEOT EXPERT - 806 - 807

<p><b>¡Nuevo!</b></p>  <p><b>4486</b> bieleta tirante de reacción motor 1.8-2.0 gasolina, r.o. 1806.34</p>	<p><b>¡Nuevo!</b></p>  <p><b>4744</b> bieleta tirante reacción y tirante trasero completo, r.o.</p>	<p><b>¡Nuevo!</b></p>  <p><b>5055</b> bieleta puntal barra estabilizadora 807 r.o.5087.51</p>
 <p><b>90038</b> bujes rueda delantera r.o.3307.64</p>	 <p><b>96032</b> latiguillo freno delantero (515 mm) r.o.4806.82</p>	 <p><b>96167</b> latiguillo freno trasero (275 mm) r.o.4806.67</p>
 <p><b>4159</b> bieleta mando cambio, rótulas de Ø 13 mm (extensible de 75 a 105 mm) r.o.</p>	 <p><b>4043</b> juego casquillos horquilla embrague motores XU y DW, r.o. 2175.20 - 2175.21</p>	 <p><b>4052</b> horquilla embrague completa con casquillos motores XU y 1.9DW8, r.o. 2115.25</p>
<p><b>¡Nuevo!</b></p>  <p><b>4605</b> casquillo guía embrague con retén r.o.2105.35</p>	 <p><b>4066</b> horquilla embrague motor 1.9DW8 y 2.0HDi r.o.2117.58</p>	<p><b>¡Nuevo!</b></p>  <p><b>4799</b> horquilla embrague motor 2.1TD y 2.0HDi completa con casquillos, r.o. 2117.59</p>
<p><b>¡Nuevo!</b></p>  <p><b>4562</b> polea cigueñal 2.0 gasolina-EW10 d/'01 r.o.0515.R1</p>	<p><b>¡Nuevo!</b></p>  <p><b>4485</b> polea cigueñal 1.8 gasolina (XU7) r.o.0515.H6</p>	<p><b>¡Nuevo!</b></p>  <p><b>4443</b> polea cigueñal 2.0 gasolina-EW10 hasta '01 r.o.0515.N3</p>
 <p><b>2926</b> polea cigueñal 1.9 D (XUD, hasta '98) r.o.0515.G3</p>	 <p><b>2927</b> polea cigueñal 1.9 DW8 sin aire acond. r.o.0515.Q6</p>	 <p><b>2928</b> polea cigueñal 1.9DW8-2.0HDi hasta 10/'04 r.o.0515.P2</p>
<p><b>¡Nuevo!</b></p>  <p><b>4477</b> polea cigueñal 1.9DW8-2.0HDi desde 10/'04 r.o.0515.S4</p>	<p><b>¡Nuevo!</b></p>  <p><b>4738</b> polea cigueñal 2.0HDi/16v r.o.0515.R9</p>	<p><b>¡Nuevo!</b></p>  <p><b>4479</b> soporte tapa cubre motor 2.0HDi r.o.0137.11-0137.23</p>

PEUGEOT EXPERT - 806 - 807

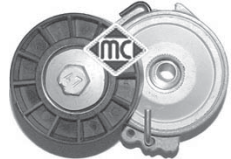
<p><b>¡Nuevo!</b></p>  <p><b>3642</b> tapón llenado aceite 1.9DW8-2.0HDi r.o. 1180.F9</p>	<p><b>¡Nuevo!</b></p>  <p><b>4612</b> varilla nivel aceite 1.9D-TD (XUD) r.o. 1174.15</p>	 <p><b>1370</b> fuelle cremallera dirección dcho. e izqd. r.o. 4066.41</p>
 <p><b>1996</b> kit rep. transmisión l/rda 1.6 - 1.8 (cambio BE3)r.o. 3293.01</p>	 <p><b>1520</b> kit rep. transmisión l/rda 1.6 - 1.8 (cambio BE3R)r.o. 3293.96</p>	 <p><b>1222</b> kit rep. transmisión l/rda 1.9 Diesel r.o. 3293.02</p>
 <p><b>1217</b> kit rep. transmisión l/rda Turbo D r.o. 3293.00</p>	 <p><b>1499</b> kit rep. transmisión l/rda 2.0 HDi r.o. 3293.06</p>	 <p><b>1362</b> kit rep. transmisión l/cbo. todos salvo 1.9D r.o. 3287.79</p>
 <p><b>1213</b> kit rep. transmisión l/cbo. 1.9 Diesel r.o. 3287.81</p>	<p><b>¡Nuevo!</b></p>  <p><b>4564</b>      Ø 30/47 y 40/58 mm juego retenes diferencial-transmisión (cambio BE3-BE4), r.o. 3121.44+3121.46</p>	<p><b>¡Nuevo!</b></p>  <p><b>4620</b>      Ø 32/50 y 40/58 mm juego retenes diferencial-transmisión (cambio ME-ML5T), r.o. 3121.44+3121.24</p>
<p><b>¡Nuevo!</b></p>  <p><b>3651</b> tapa filtro gasoil 1.9 DW8 con junta y clip de cierre, r.o. 1904.27+1904.26</p>	 <p><b>2931</b> tensor correa alternador completo 1.9D r.o. 5751.81</p>	<p><b>¡Nuevo!</b></p>  <p><b>3698</b> juego tapas correa distribución 1.9D -'99 (XUD), r.o. 0320.H2/H3/F9</p>
<p><b>¡Nuevo!</b></p>  <p><b>3700</b> juego tapas correa distribución 1.9D '99- (DW8), r.o. 0320.N3/X6/N4</p>	<p><b>¡Nuevo!</b></p>  <p><b>3699</b> juego tapas correa distribución 2.0HDi (DW10), r.o. 0320.N5/N6/S7</p>	<p><b>¡Nuevo!</b></p>  <p><b>5043</b> tensor correa alternador 1.9 DW8 sin A/C r.o. 5751.74</p>
<p><b>¡Nuevo!</b></p>  <p><b>4609</b> tensor correa alternador 1.9 D r.o. 5751.38</p>	<p><b>¡Nuevo!</b></p>  <p><b>4826</b> tensor correa alternador 1.9 D-TD-DW8 r.o. 5751.30</p>	<p><b>¡Nuevo!</b></p>  <p><b>4807</b> tensor correa alternador 2.0HDi r.o. 5751.55</p>

PEUGEOT EXPERT - 806 - 807

<p><b>4929</b> rodillo tensor correa alternador 1.8 con A/C r.o.5751.20</p>	<p><b>4895</b> tensor correa alternador 1.8 con A/C r.o.5751.35</p>	<p><b>4995</b> rodillo tensor correa alternador 1.9DW8-2.0HDi con A/C, r.o. 5751.29</p>
<p><b>4996</b> rodillo tensor correa alternador 2.0HDi sin A/C, r.o.5751.96-5751.57</p>	<p><b>4928</b> rodillo tensor correa alternador 1.9DW8 sin A/C, r.o. 5751.73</p>	<p><b>4915</b>      <b>Ø 54,60 mm</b> polea de alternador de rueda libre r.o.</p>
<p><b>4916</b>      <b>Ø 58,50 mm</b> polea de alternador de rueda libre r.o.</p>	<p><b>2938</b>      <b>junta de Ø 58 x 45 mm</b> kit montaje colector escape 1.9 D (DW8) r.o.1797.12</p>	<p><b>2940</b>      <b>junta de Ø 80 x 66 mm</b> kit montaje colector escape 1.6-1.8 gasolina r.o.1798.80-1798.75</p>
<p><b>2951</b>      <b>junta de Ø 71 x 58 mm</b> kit montaje colector escape 1.9 TD (XUD9TE) r.o.1797.22-1798.79</p>	<p><b>2952</b>      <b>junta de Ø 60 x 46 mm</b> kit montaje colector escape 1.9 D (XUD9) r.o. 1798.81</p>	<p><b>2950</b>      <b>junta de Ø 78 x 66 mm</b> kit montaje colector escape 2.0 HDi r.o.1797.21</p>
<p><b>2753</b> soporte tubo de escape r.o.1755.69-1755.63</p>	<p><b>2754</b> soporte tubo de escape r.o.1755.62</p>	<p><b>2770</b> cubrepedal freno r.o.4504.12</p>
<p><b>2771</b> cubrepedal embrague r.o.2130.13</p>	<p><b>2772</b> cubrepedal acelerador r.o.1604.07</p>	<p><b>2452</b> tapón carter de aceite 14 x 125 r.o.0311.21</p>
<p><b>2929</b> tapón cárter de aceite 10 x 125, 1.9 Diesel desde '99, r.o.0311.29</p>	<p><b>2050</b> arandela tapón de cárter metaloplástica (14x22), r.o.0313.27</p>	<p><b>2051</b> arandela tapón de cárter plana 10 x 21 mm r.o.0313.33</p>



PEUGEOT J5



**7350**  
mgto superior radiador  
r.o. 95572894 - 1343.58



**7351**  
mgto inferior radiador  
r.o. 95572893 - 1350.75



**709**  
goma puntal tensor brazo delantero  
r.o. 3561.08

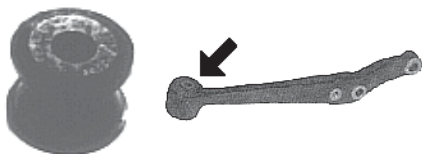

**2863**  
silentbloc brazo delantero suspensión  
r.o. no hay despiece



**1579**  
kit rep. transmisión l/rueda  
r.o. 95569342-3293.97



**1580**  
kit rep. transmisión l/cambio  
r.o.



**1820**  
fuelle cremallera asistida  
r.o. 4066.35

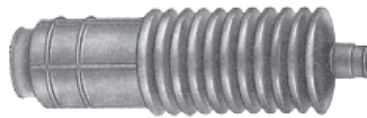

**1620**  
fuelle derecho cremallera manual  
r.o. 975000380 - 4066.19



**1621**  
fuelle izquierdo cremallera manual  
r.o. 975000280 - 4066.18



**2439**  
casquillo cremallera manual  
r.o.



**713**  
soporte de motor derecho  
r.o. 1843.94



**714**  
soporte motor izquierdo  
r.o. 1843.93



**650**  
soporte cambio hasta '91  
r.o. 1843.61

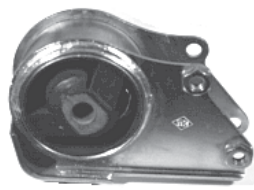

**837**  
soporte cambio desde '91  
r.o. 1843.98



**2470**  
cubrepedal freno y embrague  
r.o.



**366**  
soporte tubo de escape (Ø 32x59)  
r.o. 1755.38 - 1755.60



**667**  
tapón cárter de aceite 16x150  
r.o.

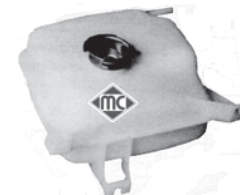

**3526**  
botella de expansión  
r.o. 1303.78



**90031**  
buje rueda delantera desde '90 (cuello para retén de Ø 69 mm), r.o.



**96144**  
latiguillo freno delantero  
r.o. 4806.35-4806.36



**96095**  
latiguillo freno trasero  
r.o. 4816.27



## PEUGEOT PARTNER

### CANALIZACIONES DE AGUA:

#### mgtos. PARTNER gasolina motores 1.1 - 1.4 y 1.6 TU (hasta '02):

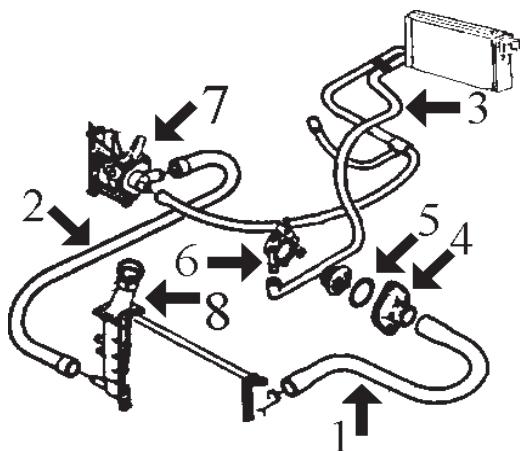

- 1- 8266 mgtto superior radiador 1.1  
8298 mgtto superior radiador 1.4-1.6 hasta PR-8025 ('98)  
8607 mgtto superior radiador 1.4-1.6 desde PR-8026 ('98)
- 2- 8265 mgtto inferior radiador hasta PR-8025 ('98)  
2113 junta tórica para mgtto inferior ref. 8265  
8476 mgtto inferior radiador desde PR-8026 ('98)  
2113 junta tórica conector rápido mgtto inferior
- 3- 8300 mgtto doble de calefacción hasta '98  
8535 mgtto doble de calefacción desde '98
- 4- 3011 tapa de termostato hasta '98 (metálica)  
3611 tapa con termostato desde '98 (plástico)
- 5- 2351 junta de termostato hasta '98
- 6- 3081 boquilla metálica inferior en caja termostato  
3082 boquilla metálica superior en caja termostato
- 7- 3578 tapa bomba de agua 1.1-1.4  
3640 tapa bomba de agua 1.6
- 8- 3548 tapón de radiador (1.4 bar)

#### mgtos. PARTNER gasolina motor 1.8 (XU7JB)

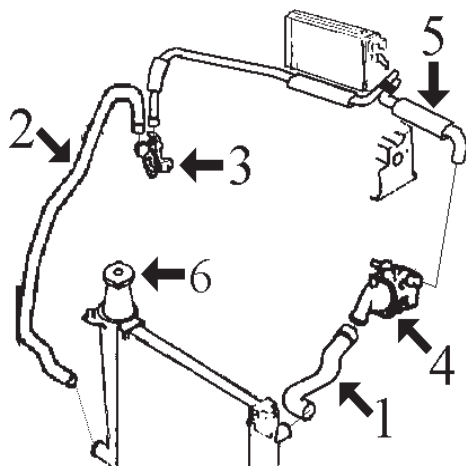

- 1- 8295 mgtto superior radiador
  - 2- 8294 mgtto inferior radiador hasta PR-8025 ('98)  
2113 junta tórica para mgtto inferior ref. 8294  
8477 mgtto inferior radiador desde PR-8026 ('98)  
2113 junta tórica conector rápido mgtto inferior
  - 3- 3523 brida agua conexión manguitos agua
  - 4- 3538 tapa de termostato  
2351 junta de termostato  
3077 boquilla metálica en caja termostato Ø 19 mm  
3078 boquilla metálica en caja termostato Ø 10 mm
  - 5- 8301 mgtto doble de calefacción
  - 6- 3548 tapón de radiador (1.4 bar)
- 8854 mgtto desvaporizador

#### mgtos. PARTNER 1.7 y 1.9 Diesel, motores XUD7 y XUD9 (hasta '99)

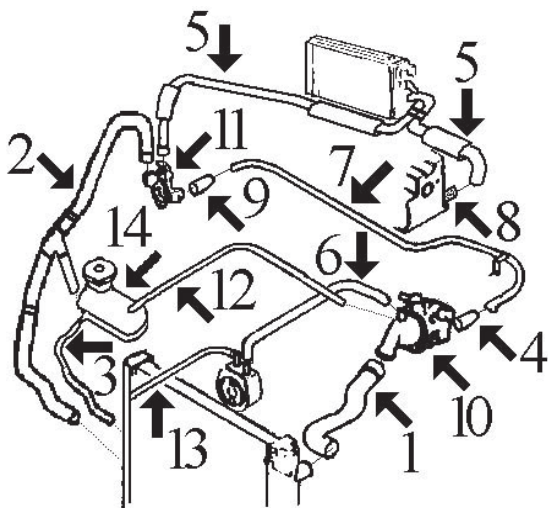

- 1- 8268 mgtto superior radiador hasta '97 (3 vias)  
8437 mgtto superior radiador desde '97
- 2- 8436 mgtto inferior radiador hasta PR-8025 ('98)  
2113 junta tórica para mgtto inferior ref. 8436  
8479 mgtto inferior radiador desde PR-8026 ('98)  
2113 junta tórica conector rápido mgtto inferior
- 3- 116 mgtto de botella a radiador, cortar de rollo MC-116, Ø 8x14 longitud 250 mm.
- 4- 8183 mgtto de tubo metálico a caja termostato hasta '98  
8480 mgtto de tubo metálico a caja termostato desde '98
- 5- 8303 mgtto doble de calefactor hasta PR-8576 ('98)  
8482 mgtto doble de calefactor desde PR-8576 ('98)
- 6- 8313 mgtto de intercambiador a caja termostato
- 7- 3057 tubo metálico
- 8- 3059 boquilla en culata
- 9- 8312 mgtto de tubo metálico a brida conexión mgttos.
- 10- 3539 tapa de termostato  
2361 junta de termostato Ø 51x58 mm
- 11- 3503 brida agua conexión manguitos
- 12- 116 mgtto de botella a caja de termostato. Cortar de rollo MC-116, Ø 8x14 longitud 750 mm
- 13- 8438 mgtto de intercambiador a radiador d/ '97 (sólo cuando el mgtto sup. radiador NO es de 3 vias)
- 14- 3545 botella de expansión  
3548 tapón botella de expansión 1.4 bar

## PEUGEOT PARTNER

mgtos. PARTNER 1.9 Diesel motor DW8 (desde '99 hasta '02):

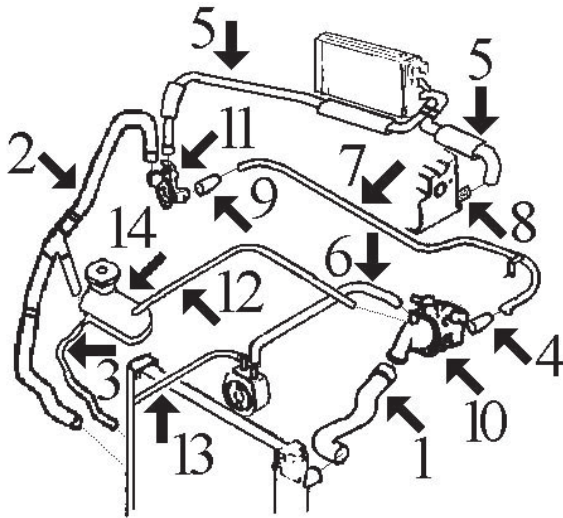

- 1- 8437 mgtto superior radiador
- 2- 8479 mgtto inferior radiador
- 3- 116 mgtto de botella a radiador, cortar de rollo MC-116, Ø 8x14 longitud 250 mm.
- 4- 8480 mgtto de tubo metálico a caja termostato
- 5- 8482 mgtto doble de calefactor
- 6- 8478 mgtto de intercambiador a caja termostato
- 7- 3129 tubo metálico
- 8- 3059 boquilla en culata
- 9- 8312 mgtto de tubo metálico a brida conexión mgtos.
- 10- 3539 tapa de termostato
- 2361 junta de termostato Ø 51x58 mm
- 11- 3544 brida agua conexión manguitos
- 12- 116 mgtto de botella a caja de termostato. Cortar de rollo MC-116, Ø 8x14 longitud 930 mm
- 13- 8481 mgtto de intercambiador a radiador
- 14- 3545 botella de expansión
- 3548 tapón botella de expansión 1.4 bar

mgtos. PARTNER 2.0 Diesel HDI, motor DW10 (hasta '02):

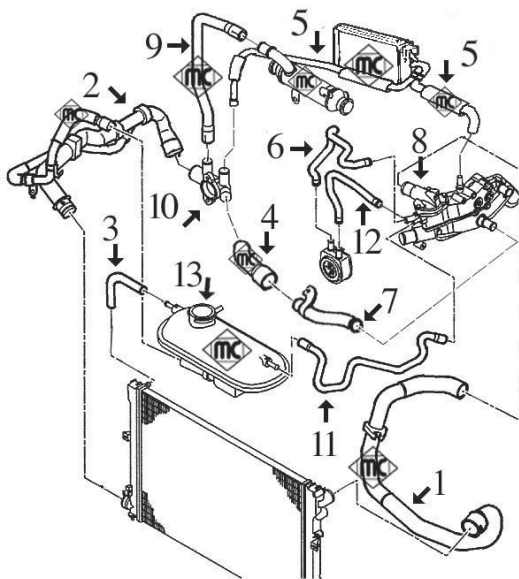





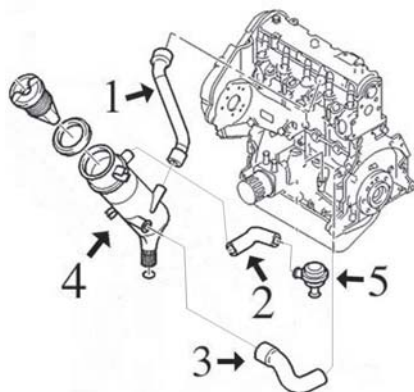



















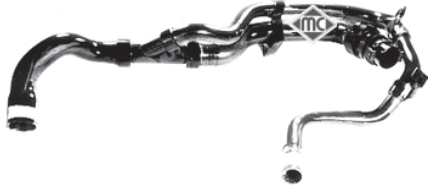

- 1- 8553 mgtto superior radiador
- 2- 8479 mgtto inferior radiador
- 3- 116 mgtto de botella a radiador, cortar de rollo MC-116, Ø 8x14 longitud 250 mm.
- 4- 8575 mgtto de tubo metálico a racor entrada
- 5- 8555 mgtto doble de calefactor
- 6- 8554 mgtto de intercambiador a caja termostato
- 7- 3139 tubo metálico con junta tórica
- 8- 3135 tapa de termostato (aluminio)
- 3556 tapa de termostato (plástico)
- 9- 8668 mgtto de racor a filtro de partículas
- 10- 3544 racor plástico conexión manguitos
- 11- 8658 mgtto de botella a caja termostato
- 12- 8586 mgtto de intercambiador a caja termostato
- 13- 3545 botella de expansión
- 3548 tapón botella de expansión 1.4 bar

mgtos. DESVAPORIZADORES 1.7D - 1.9D/TD y 2.0 Diesel HDi





















- 1- 8307 mgtto de tapa balancines a decantador motores XUD
- 8475 mgtto de tapa balancines a colector motor 1.9 DW8
- 8539 mgtto de tapa balancines a colector motor 2.0 HDi
- 2- 8473 mgtto de decantador a válvula motor 1.7 XUD
- 8167 mgtto de decantador a válvula motor 1.9 XUD
- 3- 8166 mgtto de bloque a decantador motores 1.7-1.9 XUD
- 8474 mgtto de bloque a culata motor 1.9 DW8
- 8540 mgtto de bloque a culata motor 2.0 HDi
- 4- 3631 decantador completo con tapón 1.7D-1.9D-1.9TD
- 5- 3637 válvula desvaporizadora 1.7D-1.9D (motores XUD)

## PEUGEOT PARTNER

  <p><b>8166</b> mgto desvaporizador Diesel r.o. 1192.48</p>	  <p><b>8167</b> mgto desvaporizador Diesel r.o. 1180.A3</p>	 <p><b>8183</b> mgto de termostato a tubo metálico Diesel r.o. 1307.W3</p>
 <p><b>8265</b> mgto inferior radiador 1.1 y 1.4 r.o. 1351.J4</p>	 <p><b>8266</b> mgto superior radiador 1.1 r.o. 1343.V6</p>	 <p><b>8268</b> mgto superior radiador Diesel hasta '97 r.o. 1343.V5</p>
 <p><b>8294</b> mgto inferior radiador 1.8 gasolina r.o. 1351.V5</p>	 <p><b>8295</b> mgto superior radiador 1.8 gasolina r.o. 1343.X4</p>	 <p><b>8298</b> mgto superior radiador 1.4 r.o. 1343.J3</p>
 <p><b>8300</b> mgto doble de calefactor 1.1 - 1.4 r.o. 6464.PW</p>	 <p><b>8301</b> mgto doble de calefactor 1.8 gasolina r.o. 6464.PZ</p>	 <p><b>8303</b> mgto doble de calefactor Diesel r.o. 6464.NV</p>
  <p><b>8307</b> mgto desvaporizador Diesel r.o. 1180.86</p>	 <p><b>8312</b> mgto de tubo metálico a brida de conexión Diesel, r.o. 1307.W4</p>	 <p><b>8313</b> mgto de intercambiador a termost. Diesel r.o. 1307.AA</p>
 <p><b>8436</b> mgto inferior radiador Diesel r.o. 1351.V8</p>	 <p><b>8437</b> mgto superior radiador Diesel desde '97 r.o. 1343.X2</p>	 <p><b>8438</b> mgto de intercambiador a radiador d/'97 r.o. 1307.JP</p>
  <p><b>8473</b> mgto desvaporizador 1.7-1.9 XUD r.o. 1180.A1</p>	  <p><b>8474</b> mgto desvaporizador 1.9 D (DW8) desde '99 r.o. 1180.G4</p>	  <p><b>8475</b> mgto desvaporizador 1.9D (DW8) desde '99 r.o. 1180.G5</p>

## PEUGEOT PARTNER

 <p><b>8476</b> mgto inf radiador 1.1-1.4 TU desde '98 r.o.</p>	 <p><b>8477</b> mgto inf radiador 1.8 gasolina desde '98 r.o.</p>	 <p><b>8478</b> mgto de intercambiador a tapa 1.9D '99 r.o.</p>
 <p><b>8479</b> mgto inf radiador 1.9 D desde '99 r.o.</p>	 <p><b>8480</b> mgto de caja termost. a tubo 1.9D '99 r.o.</p>	 <p><b>8481</b> mgto de intercambiador a radiador 1.9D '99 r.o.</p>
 <p><b>8482</b> mgto calefactor 1.9 D desde '99 (DW8) r.o.</p>	 <p><b>8535</b> mgto doble calefactor 1.1-1.4 desde '98 r.o.</p>	 <p><b>8539</b> mgto desvaporizador 2.0 HDi r.o.</p>
 <p><b>8540</b> mgto desvaporizador 2.0 HDi r.o.</p>	 <p><b>8553</b> mgto superior radiador 2.0 HDi r.o.</p>	 <p><b>8554</b> mgto de intercambiador a caja 2.0 HDi r.o.</p>
 <p><b>8555</b> mgto doble calefactor 2.0 HDi r.o.</p>	 <p><b>8575</b> mgto de caja termostato a tubo 2.0 HDi r.o.</p>	 <p><b>8586</b> mgto intercamb. filtro de aceite 2.0 HDi r.o.</p>
 <p><b>8607</b> mgto superior radiador 1.4 desde '98 r.o.</p>	 <p><b>8658</b> mgto de botella a caja termostato 2.0 HDi r.o.</p>	 <p><b>8668</b> mgto de racor a filtro de partículas 2.0 HDi r.o. 1307.RS</p>
 <p><b>8854</b> mgto desvaporizador 1.8 XU r.o. 1180.62</p>		



## PEUGEOT PARTNER



**3011**

tapa de termostato 1.1 - 1.4 hasta '98  
r.o. 97523152



**3057**

tubo metálico 1.9 Diesel hasta '98  
r.o. 1307.W2



**3059**

boquilla en culata Diesel salvo HDi  
r.o. 0245.42 - 0245.44



**3077**

boquilla en caja termostato 1.8  
r.o. 1341.63



**3078**

boquilla en caja termostato 1.8  
r.o. 1336.K8



**3081**

Ø 15,5 mm  
boquilla en caja termostato 1.1 - 1.4  
r.o. 96064657



**3082**

Ø 10 mm  
boquilla en caja termostato 1.1 - 1.4  
r.o. 96064659



**3129**

tubo de agua 1.9 Diesel desde '99 (DW8)  
r.o. 1307.NY



**3135**

tapa de termostato 2.0 HDi (aluminio)  
r.o. 1336.P2



**3139**

tubo de agua 2.0 HDi con junta tórica  
r.o. 1307.YZ

**¡nuevo!**



**3171**

boquilla en caja termostato 1.8-1.9D  
r.o. 1336.N7



**3503**

con junta tórica  
brida conexión manguitos Diesel hasta '98  
r.o. 1336.G4

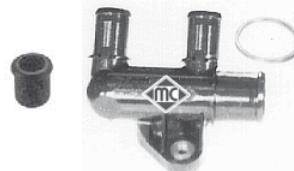

**3523**

con junta tórica  
brida conexión manguitos 1.8  
r.o. 1336.H7 - 1336.J7



**3538**

tapa de termostato 1.8 gasolina  
r.o. 1336.A1



**3539**

tapa de termostato 1.7 - 1.9 Diesel  
r.o. 1336.C9



**3544**

brida conex. mgts 1.9 D desde '99 y 2.0 HDi  
r.o. 1336.P0 - 1336.Q3



**3545**

botella de expansión 1.7D-1.9D y 2.0 HDi  
r.o. 1307.HN



**3548**

tapón radiador / botella expansión 1.4 bar  
r.o. 1306.C7 - 1306.84



**3556**

tapa de termostato 2.0 HDi (plástico)  
r.o. 1336.R9



**3578**

tapa bomba de agua motores TU  
r.o. 1201.66

## PEUGEOT PARTNER



**3611**  
tapa con termostato 1.1 - 1.4 desde '98  
r.o. 1336.Q2



**3631**  
decantador completo con tapón motor 1.7D-  
1.9XUD y 1.9XUDTE, r.o. 1180.95

**¡Nuevo!**



**3637**  
válvula desvaporizadora 1.9D XUD  
r.o. 0361.58

**¡Nuevo!**



**3640**  
tapa bomba de agua 1.6 TU (TU5J)  
r.o. 1201.C3

**¡Nuevo!**



**3641**  
tapa bomba de agua 1.1-1.4 desde '02-  
r.o. 1201.C2

**¡Nuevo!**



**3658**  
botella de expansión desde '02- con tapón  
sensor, r.o. 1323.23



**2361**                      **Ø 51 x 58 mm**  
junta de termostato Diesel  
r.o. 1339.92



**2351**                      **Ø 41 x 47 mm**  
junta de termostato 1.8  
r.o. 1339.53

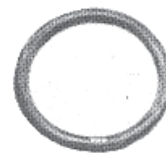

**2113**                      **Ø 33,5 x 3,15 mm**  
junta tórica conector mgto inferior radiad.  
(hasta '98) r.o. 1307.V8

## SUSPENSION DELANTERA y SOPORTES DE MOTOR

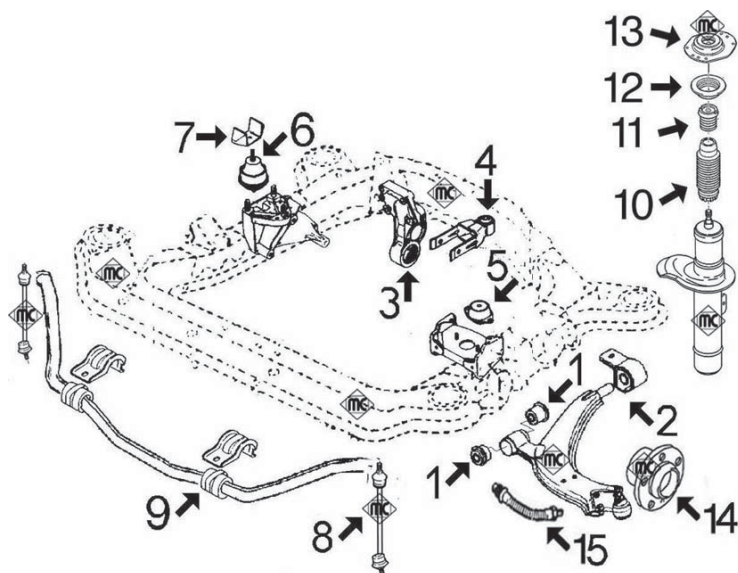

- 1- 962 silentbloc anterior trapecio delantero
- 2- 979 silentbloc posterior trapecio delantero hasta '02  
4063 silentbloc posterior trapecio delantero desde '02
- 3- 751 silentbloc soporte post. motor 1.1 - 1.4 hasta '98  
4064 silentbloc soporte post. motor 1.1 - 1.4 desde '98  
2869 silentbloc soporte posterior motor 1.8 gasolina y 1.9 Diesel hasta '98  
2980 silentbloc soporte posterior motor 1.9 D desde '98 y 2.0 HDi
- 4- 4743 tirante posterior de motor completo 1.1-1.4.1.6  
4745 tirante posterior de motor completo 1.8XU, 1.9XUD, 1.9DW8 hasta '02 y 2.0HDi hasta '02  
4746 tirante posterior de motor completo 1.9DW8 desde '02 y 2.0HDi desde '02  
877 silentbloc tirante posterior de motor 1.1 - 1.4  
2871 silentbloc tirante posterior de motor 1.8 y Diesel
- 5- 2786 soporte izquierdo de motor 1.1 - 1.4  
2794 soporte izquierdo de motor 1.8 y Diesel
- 6- 697 soporte derecho motor 1.1 - 1.4 y 1.8  
2309 soporte derecho motor Diesel
- 7- 2884 limitador superior soporte derecho motor
- 8- 2937 bieleta puntal barra estabilizadora
- 9- 2412 goma barra estabilizadora para barra de Ø 21 mm  
2932 goma barra estabilizadora para barra de Ø 22 mm
- 10- 2933 capuchón amortiguador
- 11- 2971 tope poliuretano hasta '97  
2934 tope poliuretano desde '98
- 12- 4181 rodamiento
- 13- 2935 soporte amortiguador dcho. e izqdo. (reversible)
- 14- 90012 buje de rueda delantera
- 15- 96015 latiguillo freno delantero

## SUSPENSION TRASERA

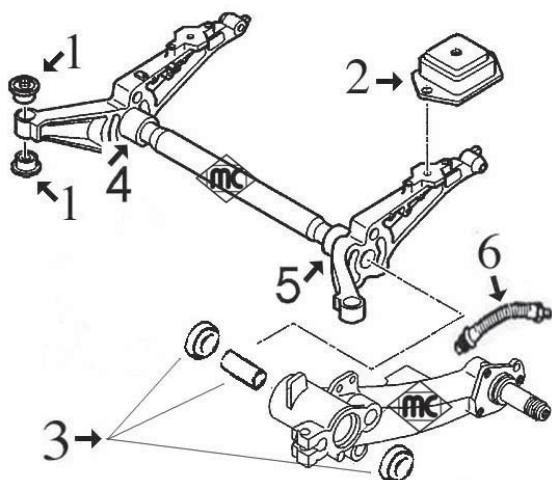

- 1- 4247 silentblocs puente trasero
- 2- 2936 soporte posterior puente
- 3- 4414 juego reparación brazo trasero completo con rodamientos, retenes y casquillos
- 4- 4552 eje brazo trasero derecho
- 5- 4551 eje brazo trasero izquierdo
- 6- 96016 latiguillo freno trasero (255 mm)

## PEUGEOT PARTNER

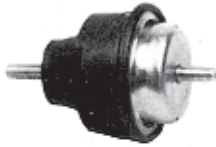

**697** **HIDRAULICO (650 g.)**  
soporte de motor derecho 1.1 - 1.4 y 1.8  
r.o. 1844.38

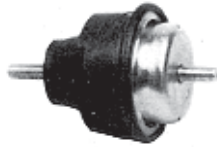

**697/1** **no hidráulico (460 g.)**  
soporte de motor derecho 1.1 - 1.4 y 1.8  
r.o. ----



**751** **Ø 65 mm**  
silentbloc soporte de motor trasero 1.1 - 1.4  
hasta '98. r.o. no hay despiece

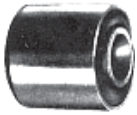

**877**  
silentbloc tirante post. motor 1.1 - 1.4  
r.o. 1809.04 (12x30x28x34)



**962**  
silentbloc anterior trapecio delantero  
r.o. no hay despiece

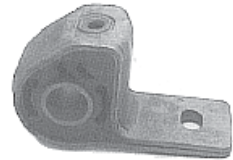

**979**  
silentbloc posterior trapecio delantero has-  
ta '02, r.o. no hay despiece



**2309** **HIDRAULICO (950 g.)**  
soporte de motor derecho Diesel  
r.o. 1844.47



**2309/1** **no hidráulico (610 g.)**  
soporte de motor derecho Diesel  
r.o. ----



**2412** **con ánima metálica**  
goma para barra estabilizadora de 21 mm  
r.o. 5094.65



**2786**  
soporte de motor izquierdo 1.1 - 1.4  
r.o. 1844.51

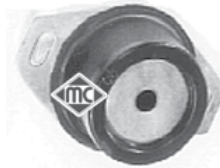

**2794**  
soporte de motor izquierdo 1.8 y Diesel  
r.o. 1844.36



**2869** **Ø 70 mm**  
silentbloc soporte de motor trasero 1.8 y D  
hasta '98. r.o. 1809.16



**2871**  
silentbloc tirante posterior motor 1.1 - 1.4  
r.o. 1809.22



**2884**  
limitador soporte de motor derecho  
r.o. 1844.25



**2932** **con ánima metálica**  
goma para barra estabilizadora de 22 mm  
r.o. 5094.77



**2933**  
capuchón amortiguador delantero  
r.o. 5254.13



**2934**  
tope suspensión delantera, altura **109 mm**  
r.o. 5033.40



**2935** **reversible**  
soporte amortiguador delantero dcho. e  
izqdo., r.o. 5038.24-5038.23-5038.21



**2936**  
soporte posterior puente trasero  
r.o. 5152.62



**2937**  
bioleta puntal barra estabilizadora delantera  
r.o. 5087.46



**2971**  
tope suspensión delantera, altura **98 mm**  
r.o. 5033.27 - 5033.51



## PEUGEOT PARTNER



**2980**  
silentbloc soporte de motor trasero 1.8 y D desde '98, r.o. 1809.21



**4063**  
silentbloc trapecio delantero desde '02- r.o. 3523.83



**4064** **Ø 65 mm**  
silentbloc soporte de motor trasero 1.1-1.4 desde '98, r.o. no hay despiece



**4181**  
rodamiento en soporte amortiguador r.o. 5035.27



**4247**  
silentbloc puente trasero r.o. 5131.47



**4414**  
jgo. reparación brazo trasero completo con rodamientos, r.o. 5131.48+5131.49



**4743** **Ø 12 mm**  
tirante trasero motor completo 1.1-1.4-1.6 r.o.



**4745** **Ø 10 mm**  
tirante trasero motor completo 1.8-1.9-2.0 r.o.



**4746** **Ø 12 mm**  
tirante trasero motor completo 1.9D y 2.0 HDi desde '02-, r.o.



**4551**  
eje brazo trasero izquierdo r.o.



**4552**  
eje brazo trasero derecho r.o.



**90012**  
buje de rueda delantera r.o. 3307.72



**96015**  
latiguillo freno delantero (483 mm) r.o. 4806.85



**96016**  
latiguillo freno trasero (255 mm) r.o. 4806.86

ARTICULACIONES PALANCA DE CAMBIO

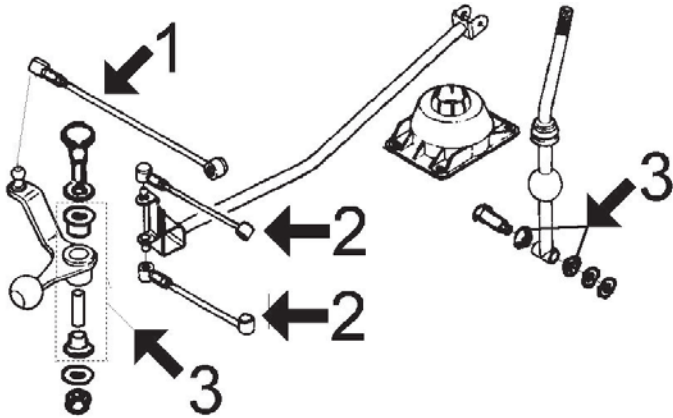

- 1- 2866 bieleta selección velocidades 1.1-1.4TU (cambio MA) y 1.8-1.9D-2.0HDi hasta '01 (cambio BE3R)
- 4420 bieleta selección velocidades 1.8-1.9DW-2.0HDi desde '01 (cambio BE4R)
- 2- 2865 bieleta selección velocidades MA-BE3R y BE4R
- 3- 4990 articulación reenvío completa con casquillos 1.1-1.4TU (cambio MA)
- 4992 articulación reenvío completa con casquillos hasta -'01, 1.8-1.9D-2.0HDi (cambio BE3R)
- 4991 articulación reenvío completa con casquillos desde '01-, 1.8-1.9D-2.0HDi (cambio BE4R)
- 2400 casquillo base palanca cambio

rótulas de Ø 13 mm  
longitud máxima 300 mm  
longitud mínima 240 mm



**2866**  
bieleta selección cambio  
r.o. 2454.E6-2454.E9

rótulas de Ø 10 mm  
longitud máxima 140 mm  
longitud mínima 80 mm



**2865**  
bieleta selección cambio  
r.o. 2452.75-2452.79

**¡Nuevo!**

rótulas de Ø 10 y Ø 13 mm  
longitud máxima 280 mm  
longitud mínima 230 mm



**4420**  
bieleta selección cambio BE4R  
r.o. 2452.81

**¡Nuevo!**



**4990**  
articulación reenvío cambio completa con casquillos, 1.1-1.4TU (cambio MA)

**¡Nuevo!**



**4992**  
articulación reenvío cambio completa con casquillos 1.8-1.9D-2.0HDi hasta -'01

**¡Nuevo!**



**4991**  
articulación reenvío cambio completa con casquillos 1.8-1.9D-2.0HDi desde -'01



**2400**  
casquillo base palanca cambio  
r.o.

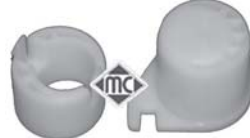

**4043**  
juego casquillos horquilla embrague motores XU y DW hasta '01, r.o. 2175.20-2175.21



**4057**  
juego casq. horquilla embrague motor TU  
r.o. 2175.11-2175.12

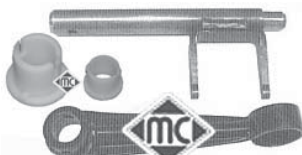

**4300**  
horquilla embrague completa con casquillos motores TU, r.o. 2117.52





















**4052**  
horquilla embrag. completa con casquillos motores XU y DW hasta '01, r.o. 2115.25

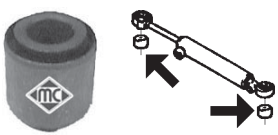
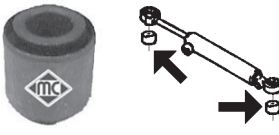

**4066**  
horquilla embrague 1.9DW8 y 1.6TU5 desde '01, r.o. 2117.58

## PEUGEOT PARTNER

<p><b>¡Nuevo!</b></p>  <p><b>4424</b> altura 55,50 mm casquillo guía embrague 1.1-1.4 TU con retén r.o. 2105.14</p>	<p><b>¡Nuevo!</b></p>  <p><b>4796</b> altura 56,50 mm casquillo guía embrague 1.1-1.4 TU con retén, r.o. 2105.38</p>	<p><b>¡Nuevo!</b></p>  <p><b>4605</b> casquillo guía embrague 1.8-1.9D-2.0HDi r.o. 2105.35</p>
<p><b>¡Nuevo!</b></p>  <p><b>3639</b> tapón llenado aceite 1.1-1.4 TU r.o. 0258.55</p>	<p><b>¡Nuevo!</b></p>  <p><b>3659</b> tapón llenado aceite 1.6 TU r.o. 0258.56-258.65</p>	<p><b>¡Nuevo!</b></p>  <p><b>3642</b> tapón llenado aceite 1.9DW8-2.0HDi r.o. 1180.F9</p>
 <p><b>2335</b> varilla nivel aceite 1.1-1.4 TU hasta '02 r.o. 1174.10-1174.49</p>	<p><b>¡Nuevo!</b></p>  <p><b>4593</b> varilla nivel aceite 1.1-1.4 TU desde '02 r.o.</p>	<p><b>¡Nuevo!</b></p>  <p><b>4612</b> varilla nivel aceite 1.9 Diesel XUD r.o. 1174.15</p>
<p><b>¡Nuevo!</b></p>  <p><b>4596</b> varilla nivel aceite 1.9DW8 r.o.</p>	<p><b>¡Nuevo!</b></p>  <p><b>4594</b> varilla nivel aceite 2.0HDi r.o.</p>	<p><b>¡Nuevo!</b></p>  <p><b>4479</b> juego silentblocs soporte tapa motor HDi r.o. 0137.68+0137.11</p>
 <p><b>1648</b> fuelle derecho cremallera manual r.o. 4066.44</p>	 <p><b>1740</b> fuelle izquierdo cremallera manual r.o. 4066.43</p>	 <p><b>287</b> juego casquillos cremallera manual r.o.</p>
 <p><b>2911</b> silentbloc pistón cremallera asistida r.o. 4059.10 (12x24x20x24)</p>	 <p><b>2410</b> silentbloc pistón cremallera asistida r.o. 4059.07 (12x22x20x24)</p>	<p><b>¡Nuevo!</b></p>  <p><b>4564</b> Ø 30/47 y 40/58 mm juego retenes diferencial-transmisión r.o. 3121.44+3121.46</p>
 <p><b>1536</b> fuelle derecho cremallera asistida r.o. 4066.22</p>	 <p><b>1268</b> fuelle izquierdo cremallera asistida r.o. 4066.20</p>	 <p><b>844</b> capuchón derecho cremallera asistida r.o. 4066.16</p>

## PEUGEOT PARTNER



**1222**

kit fuelle transmisión l/rueda 1.8-1.9D-2.0HDi  
r.o. 3293.03



**1213**

kit fuelle transm. l/cambio 1.8-1.9D-2.0HDi  
r.o. 3287.81



**1521**

kit rep. transmisión l/rda 1.1 - 1.4 hasta '98  
(salvo ABS) r.o.



**1432**

kit rep. transmisión l/rueda 1.1-1.4 hasta '98  
(con ABS) r.o.



**1533**

kit rep. transmisión l/cbo 1.1-1.4 hasta '98  
r.o. 3287.69



**1428**

kit rep. transmisión l/cbo 1.1 - 1.4 desde '98  
r.o.



**1427**

kit rep. transmisión l/rueda 1.1-1.4 desde '98  
r.o.

**¡Nuevo!**



**4440**

Ø 148 mm 6 canales  
polea cigüeñal 1.1-1.4-1.6 TU hasta 10/04  
r.o. 0515.P5-0515.R8

**¡Nuevo!**



**4442**

Ø 148 mm 6 canales  
polea cigüeñal 1.1-1.4-1.6 TU desde 10/04  
r.o. 0515.S1-0515.P1



**2926**

polea cigüeñal 1.7-1.9 Diesel XU (hasta '99)  
r.o. 0515.G3



**2927**

polea cigüeñal 1.9 Diesel DW8 (desde '99  
hasta 10/04), r.o. 0515.Q6

**¡Nuevo!**



**4610**

polea cigüeñal 1.9 Diesel DW8 (desde '02-)  
r.o. 0515.R5



**2928**

polea cigüeñal 2.0 HDi hasta 10/04  
r.o. 0515.P2

**¡Nuevo!**



**4477**

polea cigüeñal 2.0 HDi desde 10/04  
r.o. 0515.S4



**2931**

tensor correa alternador 1.9 D completo  
r.o. 5751.81

**¡Nuevo!**



**3697**

juego tapas correa distribución 1.1-1.4  
motores TU1-TU3, r.o. 0320.S2+0320.L3

**¡Nuevo!**

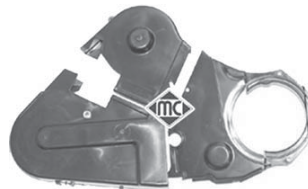

**3698**

juego tapas correa distribución 1.9D (-'99)  
motor XUD, r.o. 0320.H2+0320.H3+0320.F9

**¡Nuevo!**



**3699**

juego tapas correa distribución 2.0HDi  
motor DW10, r.o. 0320.N5/N6/S7

**¡Nuevo!**



**3700**

juego tapas correa distribución 1.9D ('99-)  
motor DW8, r.o. 0320.N3+0320.X6+0320.N4

**¡Nuevo!**



**4826**

tensor correa alternador 1.9D con A/C  
r.o. 5751.30

**¡Nuevo!**



**4609**

tensor correa alternador 1.9D sin A/C  
r.o. 5751.38



## PEUGEOT PARTNER

<p><b>¡Nuevo!</b></p>  <p><b>4928</b>      <b>Ø 10-60 / 25 mm</b> rodillo tensor correa alternador XUD-1.9DW sin a/c, r.o. 5751.73</p>	<p><b>¡Nuevo!</b></p>  <p><b>4995</b> rodillo tensor correa alternador 1.9DW8 y 2.0HDi con a/c, r.o. 5751.29</p>	<p><b>¡Nuevo!</b></p>  <p><b>4996</b> rodillo tensor correa alternador 2.0HDi sin a/c, r.o. 5751.96-5751.57</p>
<p><b>¡Nuevo!</b></p>  <p><b>4807</b>      <b>rodillo de Ø 70 mm</b> tensor correa alternador 2.0HDi r.o. 5751.55</p>	<p><b>¡Nuevo!</b></p>  <p><b>5043</b>      <b>rodillo de Ø 60 mm</b> tensor correa alternador 1.9DW8 sin A/C r.o. 5751.74</p>	
<p><b>¡Nuevo!</b></p>  <p><b>3651</b> tapa filtro gasoil 1.9DW8 con junta y clip de cierre, r.o. 1904.27+1904.26</p>	<p><b>¡Nuevo!</b></p>  <p><b>4915</b>      <b>Ø 54,60 mm</b> polea de alternador de rueda libre r.o.</p>	<p><b>¡Nuevo!</b></p>  <p><b>4916</b>      <b>Ø 58,50 mm</b> polea de alternador de rueda libre r.o.</p>
 <p><b>088</b> soporte tubo de escape r.o. 1755.61</p>	 <p><b>2692</b> soporte tubo de escape r.o. 1755.58</p>	 <p><b>4010</b> soporte tubo de escape desde '98 r.o. 1755.68</p>
 <p><b>749</b>      <b>Ø 69 mm</b> collarín enlace tubo de escape r.o.</p>	 <p><b>748</b>      <b>Ø 66 mm</b> collarín enlace tubo de escape r.o.</p>	 <p><b>2941</b>      <b>junta de Ø 60 x 46 mm</b> kit montaje colector 1.1-1.4 y 1.9 Diesel hasta '98, r.o.</p>
 <p><b>2940</b>      <b>junta de Ø 80 x 66 mm</b> kit montaje colector 1.7 Diesel (XUD7) r.o. 1798.80-1798.75</p>	 <p><b>2938</b>      <b>junta de Ø 58 x 45 mm</b> kit montaje colector 1.9 Diesel desde '98 r.o. 1797.12</p>	 <p><b>2939</b>      <b>junta de Ø 74 x 58 mm</b> kit montaje colector 2.0 HDi r.o. 1797.18</p>
 <p><b>2770</b> cubrepedal freno r.o. 4504.12</p>	 <p><b>2771</b> cubrepedal embrague r.o. 2130.13</p>	 <p><b>2772</b> cubrepedal acelerador r.o. 1604.07</p>

## PEUGEOT PARTNER



**2050**  
 arandela metaloplástica 14 x 22 (2.0HDi)  
 r.o.0313.27



**2051**  
 arandela plana 10 x 21 para tapón MC-2929  
 r.o.0313.33



**4036**  
 bomba de cebado gasoil c/ válvula antirretorno y boquilla adicional a 90°, r.o. 1579.73



**2452**  
 tapón de cárter 14 x 125, todos salvo DW8  
 r.o.0311.21



**2929**  
 tapón de cárter 10 x 125, 1.9 Diesel d/99  
 r.o.0311.29



**2024**  
 arandela tapón de cárter con junta de goma Ø 14 mm

# RENAULT 4 - 5 - 6 - F6



**7284**  
mgto superior radiador R-4 ('76-'82)  
r.o. 7700528616



**7285**  
mgto superior radiador R-4 TL y F6  
r.o. 7700580937



**7286**  
mgto inferior radiador R-4 TL y F6  
r.o. 7700581084



**7553**  
mgto superior radiador R-5  
r.o. 7700676121



**5641**  
mgto inferior radiador R-5  
r.o. 7700533016



**5638**  
mgto superior radiador R-6 GTL  
r.o. 7700520063



**5639**  
mgto inferior radiador R-6 GTL  
r.o. 7700531005



**7832**  
mgto calefactor R-4 TL y F6  
r.o. 7700695524



**7647**  
mgto calefactor R-4 TL y F6  
r.o. 7700535996



**5830**  
mgto salida calefactor R-5  
r.o. 7700541590



**5831**  
mgto entrada calefactor R-5  
r.o. 7700533153



**958**  
purgador circuito de agua  
r.o. 7700519230

**¡Nuevo!**



**3692**  
tapón de radiador  
r.o. 085364700-7701018380



**195**  
fuelle cremallera dirección R-4/5 (hasta '77)  
r.o. 7702047822

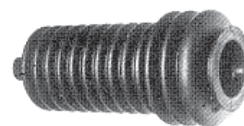

**263**  
fuelle cremallera dirección (desde '77)  
r.o. 7702118974



**286**  
juego casquillos cremallera todos modelos  
r.o. 7700542611



**152**  
dado articulación barra dirección  
r.o. 7700545821



**210**  
flector de dirección  
r.o. 7700549015

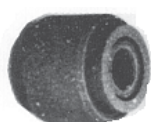

**172**  
silentbloc extremo cremallera (hasta '77)  
r.o. 7700509247 (10x28x27x20)



**1221E**  
kit rep. transm. l/rda **para montar en cono**  
(en neopreno especial de elasticidad 800%)



**1272**  
fuelle transmisión lado cambio R-4/5/6  
r.o. 7701013273

## RENAULT 4 - 5 - 6 - F6

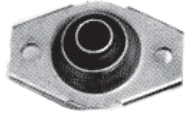

**173**  
silentbloc tirante susp. delt. R-4, R-6  
r.o. 7700500113



**565**  
silentbloc trapecio inferior delt. R-4, R-6  
r.o. 0854588500 (14x27x45x40)

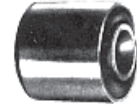

**236**  
silentbloc trapecio superior R-4, R-6  
r.o. 7702104152 (12x26x27x23)

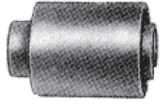

**151**  
silentbloc trapecio superior R-5  
r.o. 7700542511 (12x26x36x23)

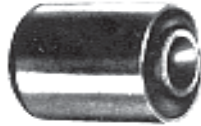

**208**  
silentbloc trapecio inferior R-5  
r.o. 7700533100 (14x34x45x40)

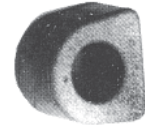

**204**  
goma barra estabilizadora todos modelos  
r.o. 0608268700



**4841**  
soporte izquierdo brazo trasero suspensión  
r.o.



**4842**  
soporte derecho brazo trasero suspensión  
r.o.



**90019**  
buje rueda delantera R-4 / R-5 / R-6  
r.o. 7700533798

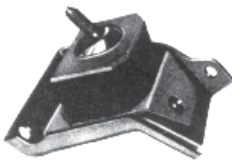

**239**  
soporte izquierdo de motor todos  
r.o. 7700527603-7700527557

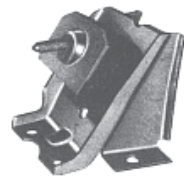

**252**  
soporte derecho de motor todos  
r.o. 7700674446-7700528173

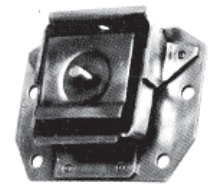

**249**  
soporte delantero cambio R-4, R-6  
r.o. 7700501493

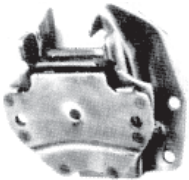

**250**  
soporte cambio R-5 (4 velocidades)  
r.o. 7700533444

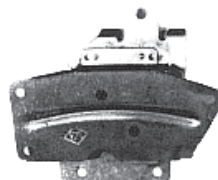

**485**  
soporte cambio R-5 (5 velocidades)  
r.o. 7700692341



**335**  
juego casquillos palanca de cambio  
r.o. 7700642281 - 7700555607



**416**  
cubrepedal freno y embrague  
r.o.



**153**  
soporte tubo de escape  
r.o. 7700511570



**667**  
tapón cárter de aceite 16x150  
r.o.

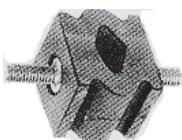

**205**  
soporte tubo de escape R-5 desde '81  
r.o. 7700656895



**167**  
soporte trasero escape R-6 (rosca M-10)  
r.o. 7700523095



**643**  
collarín colector todos modelos (Ø58mm)  
r.o.



## RENAULT 4 - 5 - 6 - F6



**96059**

latiguillo freno delantero R4-R6 (500 mm)  
r.o. 7701454835



**96058**

latiguillo freno delantero R5-R4TL (460 mm)  
r.o. 7701348800



**96060**

latiguillo freno trasero R4-R5-R6 (268 mm)  
r.o. 7704001957

CANALIZACIONES DE AGUA

R-9/11 GTC-GTL-TSE y SUPER 5 (motores C1J y C2J de 1.397 cc):

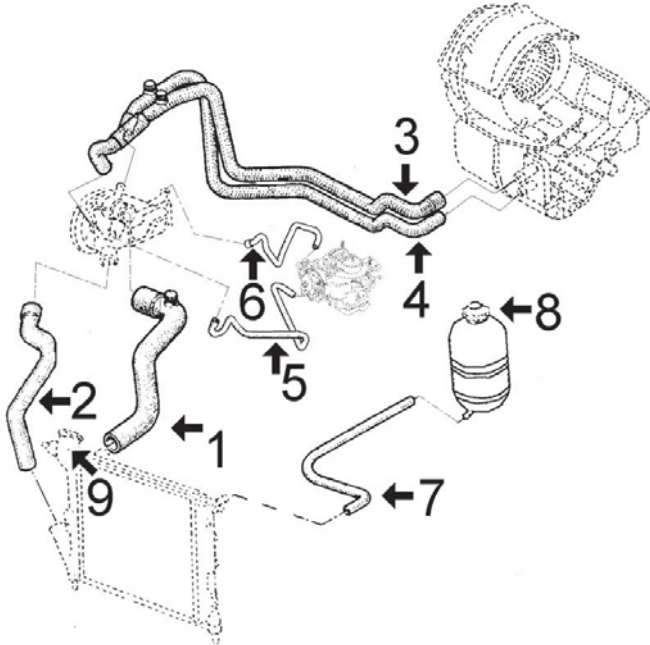

- 1- 7516 mgto sup radiador R-9/11 (sin aire acond.)
- 7519 mgto sup radiador R-9/11 (con aire acond.)
- 7512 mgto sup radiador SUPER 5
- 2- 7517 mgto inf radiador R-9/11 (sin aire acond.)
- 7518 mgto inf radiador R-9/11 (con aire acond.)
- 7668 mgto inf radiador SUPER 5
- 3- 7677 mgto de calefactor a bomba (con purgador)
- 7523 mgto de calefactor a bomba (sin purgador) h/'84
- 4- 7794 mgto de calefactor a bomba (con purgador) (\*)
- 7524 mgto de calefactor a bomba (sin purgador), versiones R-9/11 anteriores a 1984. Puede ser reemplazado por el MC-7677.
- 5- 7672 mgto de bomba a carburador (carburador monocuerpo)
- 7673 mgto de bomba a carburador (carburador doble cuerpo)
- 6- 7671 mgto de carburador a bomba (carburador monocuerpo)
- 7674 mgto de carburador a bomba (carburador doble cuerpo)
- 7- 760 mgto de botella a radiador: cortar de rollo ref. MC-760, Ø 6x11 mm
- 8- 3501 botella de expansión
- 3519 tapón de botella 0,7 bar
- 3524 tapón de botella 1,0 bar
- 3514 tapón de botella 1,20 bar
- 9- 3692 tapón de radiador (metálico)

- 7669 mgto desvaporizador
- 7670 mgto desvaporizador

(\*) ref. 7794 reemplaza a las versiones anteriores a 1984 del R-9/11 en las que el manguito de calefacción era de dos tramos con purgador intercalado (mgto MC 7523 + purgador MC 971)

R-9/11 DIESEL hasta modelo '86 (motor F8M de 1.596 cc):

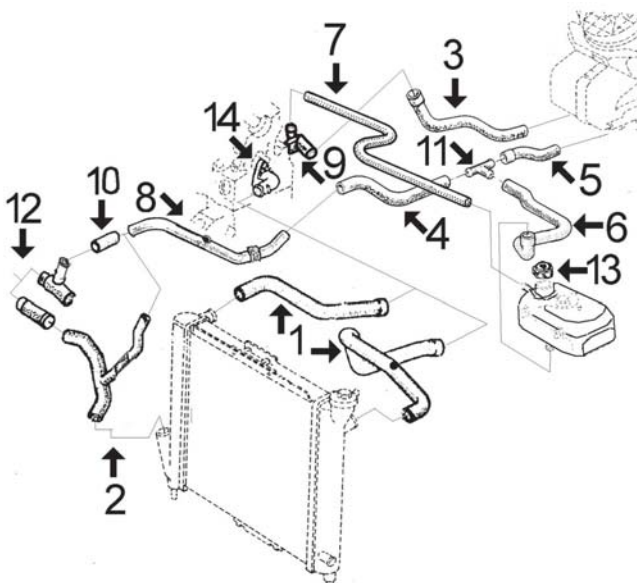

- 1- 7585 mgto superior de radiador hasta '86 (\*)
- 8068 mgto superior de radiador (versiones con boca de radiador a la derecha)
- 2- 7515 mgto inferior de radiador
- 3- n/d mgto de calefactor a boquilla en culata
- 4- 7665 mgto de racor 3 vias a tubo metálico
- 5- 7927 mgto de calefactor a racor 3 vias
- 6- 8074 mgto de racor 3 vias a botella
- 7- 8059 mgto de botella a boquilla en culata
- 8- 3031 tubo metálico
- 9- n/d boquilla 3 vias en culata
- 10- 8098 mgto de boquilla 3 vias a tubo metálico
- 11- 3051 boquilla 3 vias enlace manguitos de calefacción
- 12- 3000 boquilla entrada agua a bloque, hasta '83 (3 vias)
- 3055 boquilla entrada agua a bloque, desde '83
- 13- 3524 tapón de botella de expansión 1,00 bar
- 3514 tapón de botella de expansión 1,20 bar
- 14- 3117 tapa de termostato
- 2362 junta de termostato

- 7916 mgto desvaporizador (sintético)
- 8148 mgto desvaporizador (sintético)

(\*) Nota: mgto ref. 7585 puede ser reemplazado por 8069 (ver esquema R-9/11 Diesel modelo '86)

## RENAULT 9 - 11 - SUPER 5

### R-9/11 GTX-TXE hasta '87 (motor F2N de 1.721 cc)

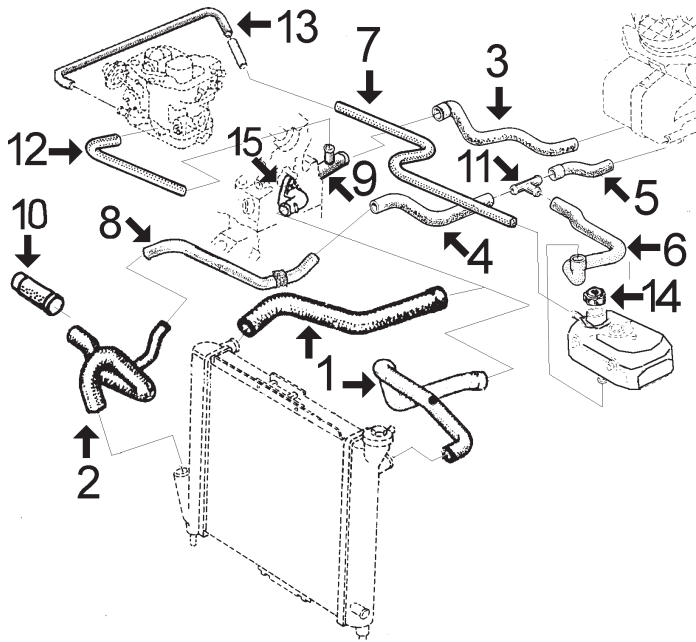

- 1- 7977 mgto superior de radiador, radiador con boca de entrada a la derecha
- 8069 mgto superior de radiador, radiador con boca de entrada a la izquierda
- 2- n/d mgto inferior de radiador
- 3- n/d mgto de calefactor a boquilla 3 vias en culata
- 4- 7665 mgto de racor 3 vias a tubo metálico
- 5- 7927 mgto de calefactor a racor 3 vias
- 6- 8074 mgto de racor 3 vias a botella
- 7- 117 mgto de botella a enlace mgto a carburador. Cortar de rolo MC 117 Ø10x17 mm, long. 75 cms.
- 8- n/d tubo metálico
- 9- 3029 boquilla 3 vias clavada en culata
- 10- 3055 boquilla entrada agua a bloque
- 11- 3051 racor 3 vias enlace manguitos de calefacción
- 12- 116 mgto de carburador a boquilla 3 vias en culata  
Cortar de rolo MC116 Ø8x14 mm (long. 21 cms)
- 13- 7954 mgto de enlace mgto de botella a carburador
- 14- 3524 tapón de botella de expansión 1,00 bar
- 3514 tapón de botella de expansión 1,20 bar
- 15- 3117 tapa de termostato
- 2362 junta de termostato

### R-9/11 GTX-TXE desde '87 y SUPER 5 GTX-90 (motor F2N de 1.721 cc)

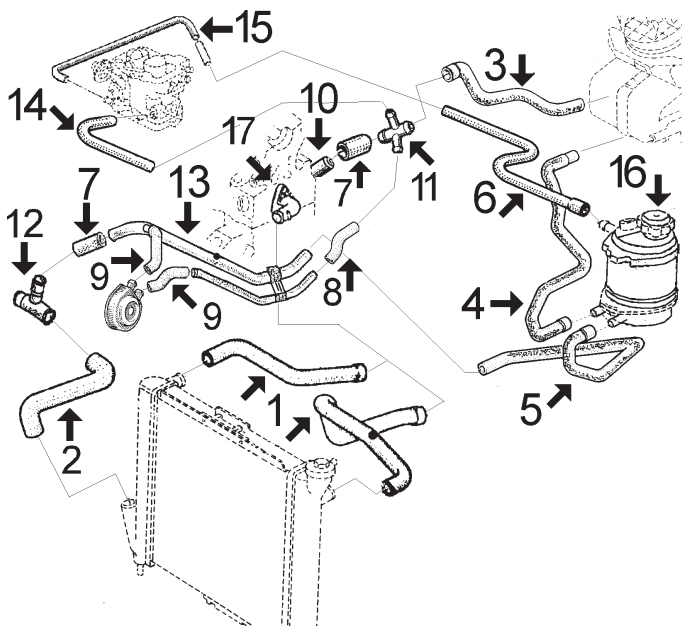

- 1- 7977 mgto sup radiador R-9/11 1.7 para radiador con boca de entrada a la derecha
- 8069 mgto sup radiador R-9/11 1.7 para radiador con boca de entrada a la izquierda
- 7508 mgto sup radiador SUPER 5 1.7
- 2- 8044 mgto inferior de radiador R-9/11 1.7
- n/d mgto inferior de radiador SUPER 5 1.7
- 3- n/d mgto de calefactor a racor 4 vias
- 4- 7974 mgto de calefactor a botella
- 5- 7975 mgto de botella a tubo
- 6- n/d mgto de botella a enlace mgto a carburador. adaptar tubo Ø10x17 long 75 cms (con purgador)
- 7- 8098 mgto de racor 3 vias a tubo metálico
- 8- n/d mgto de tubo metálico a racor 4 vias
- 9- 8096 juego dos manguitos a refrigerador aceite
- 10- 3033 boquilla clavada en culata
- 11- 3016 racor 4 vias enlace manguitos de calefacción
- 12- 3000 boquilla clavada en bloque
- 13- n/d tubo de agua metálico
- 14- 116 mgto de carburador a racor 4 vias. Cortar de rolo MC 116 Ø8x14 longitud 21 cms.
- 15- 7954 mgto de carburador a enlace mgto a botella
- 16- 3500 botella de expansión
- 3524 tapón de botella de expansión 1,00 bar
- 3514 tapón de botella de expansión 1,20 bar
- 17- 3117 tapa de termostato
- 2362 junta de termostato

n/d = no disponible

**SUPER 5 DIESEL y R-9/11 DIESEL desde modelo '86:**

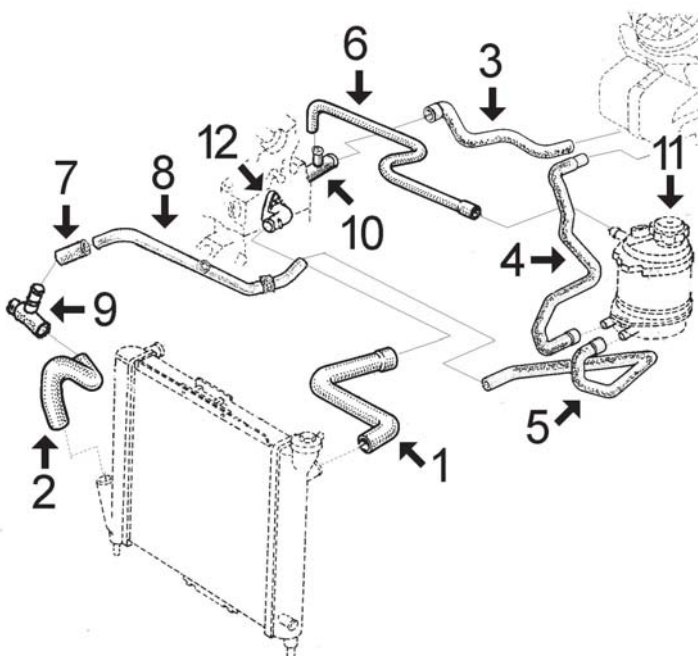

- 1- 7508 mgto superior de radiador SUPER 5D
- 8069 mgto superior de radiador R-9/11 D (boca de radiador a la izquierda)
- 8068 mgto superior de radiador R-9/11D (versiones con boca de radiador a la derecha)
- 2- 7509 mgto inferior de radiador SUPER 5D
- 8044 mgto inferior de radiador R-9/11 D
- 3- 7664 mgto de calefactor a boquilla en culata
- 4- 7974 mgto de calefactor a botella
- 5- 7975 mgto de botella a tubo metálico
- 6- 8059 mgto de botella a boquilla en culata SUPER 5 d
- n/d mgto de botella a boquilla en culata R-9/11 D (igual a 8059 pero con purgador)
- 7- 8098 mgto de boquilla 3 vias a tubo metálico
- 8- 3031 tubo metálico
- 9- 3000 boquilla 3 vias clavada en bloque
- 10- 3029 boquilla 3 vias clavada en culata
- 1- 3500 botella de expansión
- 3524 tapón de botella de expansión 1,00 bar
- 3514 tapón de botella de expansión 1,20 bar
- 2- 3117 tapa de termostato

8148 mgto desvaporizador

**SUPER 5 TURBO hasta modelo '88**

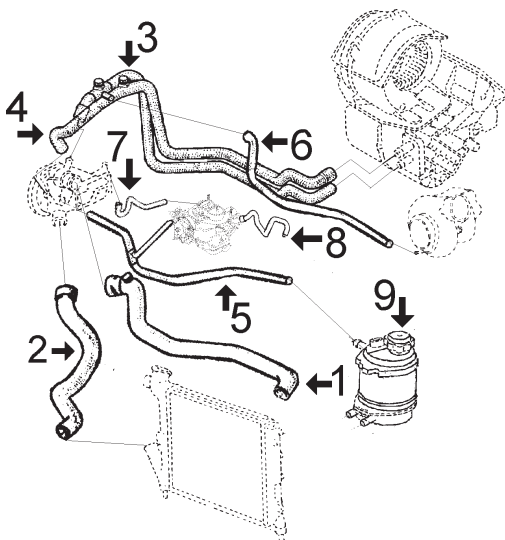















- 1- 7912 mgto superior de radiador
- 2- n/d mgto inferior de radiador
- 3- n/d mgto derecho de calefactor a bomba de agua
- 4- 7677 mgto izquierdo de calefactor a bomba de agua
- 5- n/d mgto de bomba a botella y carburador, 3 vias
- 6- n/d mgto de boquilla en mgto de calefactor a Turbo
- 7- n/d mgto de bomba a carburador
- 8- 7954 mgto de carburador a colector de admisión
- 9- 3524 tapón de botella de expansión 1,00 bar
- 3514 tapón de botella de expansión 1,20 bar



## RENAULT 9 - 11 - SUPER 5

 <p><b>7516</b> mgto superior radiador R-9/11 GTC-GTL y TSE, r.o. 7704001274 - 7700760872</p>	 <p><b>7517</b> mgto inferior radiador R-9/11 GTC-GTL y TSE, r.o. 7704001277 - 7700773175</p>	 <p><b>7519</b> mgto superior radiador R-9/11 aire acond. r.o. 7704001276</p>
 <p><b>7518</b> mgto inferior radiador R-9/11 aire acond. r.o. 7704001278</p>	 <p><b>7512</b> mgto superior radiador SUPER 5 gasolina (excepto GTX-90 y Turbo) r.o. 7700762342</p>	 <p><b>7668</b> mgto inferior radiador SUPER 5 gasolina (excepto GTX-90 y Turbo) r. 7700781076</p>
 <p><b>7912</b> mgto superior radiador R-11 TURBO y SUPER 5 TURBO, r.o. 6001006589</p>	 <p><b>7585</b> mgto superior radiador R-9/11 DIESEL hasta '86, r.o. 7704002500</p>	 <p><b>7515</b> mgto inferior radiador R-9/11 DIESEL desde '83, r.o. 7700759170</p>
 <p><b>8068</b> mgto superior radiador R-9/11 DIESEL desde '86, r.o. 7700777165</p>	 <p><b>8069</b> mgto superior radiador R-9/11 DIESEL desde '86, r.o. 7700757553</p>	 <p><b>8044</b> mgto inferior radiador R-9/11 DIESEL y GTX/TXE desde '87, r.o. 7700777164</p>
 <p><b>7977</b> mgto superior radiador R-9/11 GTX-TXE hasta '87, r.o. 7700773182</p>	 <p><b>7508</b> mgto superior radiador SUPER 5 DIESEL y GTX-90, r.o. 7700751785</p>	 <p><b>7509</b> mgto inferior radiador SUPER 5 DIESEL r.o. 7700751786</p>
 <p><b>7523</b> mgto calefactor R-9/11 hasta '84 r.o. 77040001326</p>	 <p><b>7524</b> mgto calefactor R-9/11 hasta '84 y R-11 TURBO, r.o. 7704001328</p>	 <p><b>7677</b> mgto calefactor R-9/11 y SUPER 5 gasolina (salvo GTX-TXE), r.o. 7700762034</p>
 <p><b>7794</b> mgto calefactor R-9/11 y SUPER 5 gasolina (salvo GTX-TXE), r.o. 7700762033</p>	 <p><b>7665</b> mgto calefactor R-9/11 DIESEL, 2º tramo r.o. 7700773180</p>	 <p><b>7927</b> mgto calefactor R-9/11 DIESEL, 1er. tramo r.o. 7700773178</p>

RENAULT 9 - 11 - SUPER 5

 <p><b>8074</b> mgto de racor a botella R-9/11 DIESEL r.o. 7704002499</p>	 <p><b>7974</b> mgto calefactor a botella SUPER 5 DIESEL y GTX-90, r.o. 7700781397</p>	 <p><b>7975</b> mgto de botella a tubo SUPER 5 DIESEL y GTX-90, r.o. 7700214770</p>
 <p><b>7664</b> mgto de calef. a culata SUPER 5 DIESEL r.o. 7700773179</p>	 <p><b>8059</b> mgto de racor a botella R-9/11 D-SUPER 5 DIESEL, r.o. 7700757244</p>	 <p><b>8096</b> juego mgto a intercambiad. R-9/11 GTX /TXE desde '87 y SUPER 5 GTX-90</p>
 <p><b>8098</b> mgto de boquilla a tubo rígido R-9/11 D, r.o.</p>	 <p><b>7671</b> mgto de carburador R-9/11-SUPER 5 (carburador monocuerpo) r.o. 7700726561</p>	 <p><b>7672</b> mgto de carburador R-9/11 SUPER 5 (carburador monocuerpo), r.o. 7700706840</p>
 <p><b>7673</b> mgto de carburador R-9/11 SUPER 5 (carburador doble cuerpo), r.o. 7700707107</p>	 <p><b>7674</b> mgto de carburador R-9/11 SUPER 5 (carburador doble cuerpo), 7700726562</p>	 <p><b>7954</b> mgto carburad. SUPER 5 TURBO-GTX90 R-9/11 GTX-TXE, r.o. 7700576184</p>
 <p><b>7669</b> mgto desvaporizador R-9/11 y SUPER 5 (carburador monocuerpo) r.o. 7700678777</p>	 <p><b>7670</b> mgto desvaporizador R-9/11 y SUPER 5 (carburador monocuerpo), r.o. 7700678778</p>	
 <p><b>8148</b> mgto desvaporizador R-9/11 D, SUPER 5 DIESEL, r.o. 7700714556</p>	 <p><b>3000</b> boquilla entrada agua a bloque motor R-9/11 D, SUPER 5 D, r.o. 7700860063</p>	 <p><b>3055</b> boquilla entrada agua a bloque motor R-9/11 DIESEL SUPER 5 GTX-90</p>
 <p><b>3029</b> boquilla en culata SUPER 5 DIESEL y R-9/11 D desde '86, r.o. 7700860882</p>	 <p><b>3031</b> tubo de agua 9/11 D - Super 5 D r.o. 7700860517</p>	 <p><b>3033</b> boquilla en culata R-11 TXE desde '87 y SUPER 5 GTX-90, r.o. 7705030135</p>

## RENAULT 9 - 11 - SUPER 5



**3051**  
boquilla 3 vias enlace mgts de calefacción  
r.o.



**3016**  
boquilla 4 vias enlace manguitos  
R-9/11 GTX/TXE y SUPER 5 GTX-90

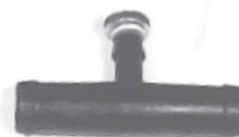

**971**  
purgador circuito de calefacción R-9/11  
r.o.



**760**  
rollo 15 mts. tubo de agua sobrante de botella R-9/11 gasolina, Ø6 x 11 mm



**2362**      **Ø 47 x 55**  
junta termostato R-9/11 GTX-TXE,  
SUPER 5 Dy GTX-90 r.o. 7700718380



**3117**  
tapa de termostato Diesel y 1.7  
r.o. 7700851979



**3500**  
botella de expansión desde '87  
r.o. 7701203218-7700810997



**3501**  
botella de expansión hasta '87  
r.o. 7701460418-7701203220



**3519**      **0,7 bar-cápsula blanca**  
tapón de botella de expansión  
r.o.



**3524**      **1,0 bar-cápsula verde**  
tapón de botella de expansión  
r.o.



**3514**      **1,2 bar-cápsula marrón**  
tapón de botella de expansión  
r.o.



**3525**      **1,4 bar-cápsula celeste**  
tapón de botella de expansión  
r.o.

**¡Nuevo!**



**3692**  
tapón de radiador (metálico)  
r.o. 7701018380

**SUSPENSION DELANTERA Y SOPORTES DE MOTOR:**

R-9/11 todos modelos (incluso Diesel) y SUPER 5 (sólo gasolina)

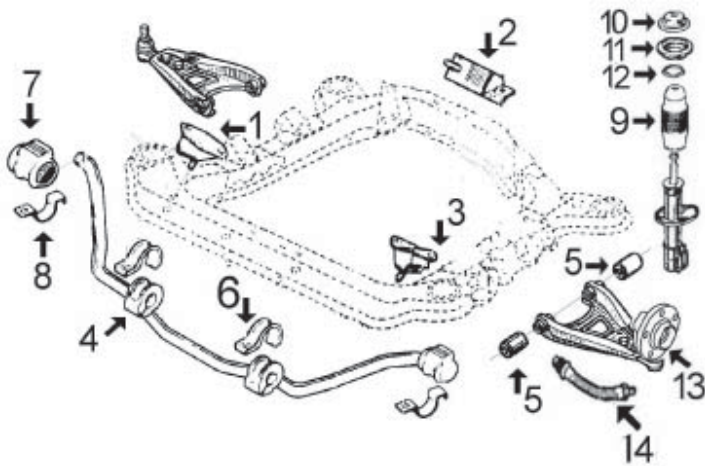

- 1- 387 soporte de motor delantero derecho
- 2- 389 soporte de motor trasero
- 3- 388 soporte de motor delantero izquierdo
- 4- 469 goma central barra estabilizadora
- 5- 360 silentbloc trapecio inferior
- 6- 828 abrazadera goma central barra estabilizadora
- 7- 466 goma puntal barra estabilizadora (Ø 22 mm)
- 468 goma puntal barra estabilizadora (Ø 21 mm)
- 8- 827 abrazadera goma puntal barra estabilizadora
- 9- 4152 capuchón con tope de goma Súper5
- 4173 capuchón amortiguador R-9/11
- 10- 4148 tapa superior amortiguador
- 11- 4147 goma apoyo amortiguador delantero Súper5
- 787 goma apoyo amortiguador delantero R-9/11
- 12- 4178 rodamiento superior amortiguador
- 13- 90015 buje rueda delantera
- 14- 96064 latiguillo freno delantero R-9/11
- 96078 latiguillo freno delantero Súper5

**SÚPER 5 DIESEL**

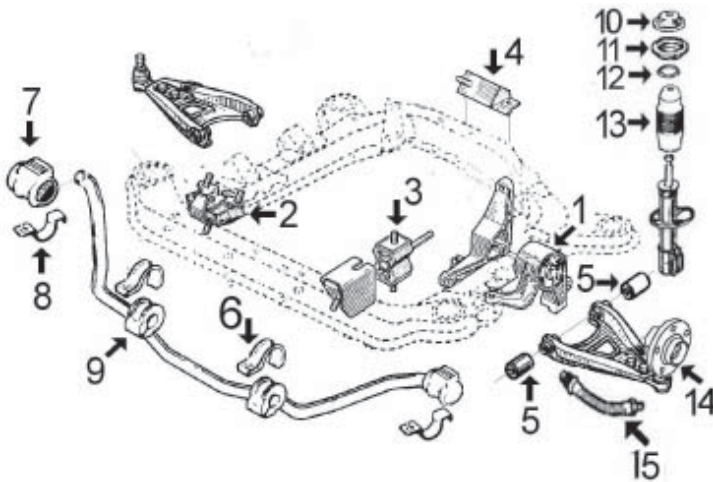

- 1- 504 soporte motor lateral izquierdo
- 2- 508 soporte motor delantero derecho
- 3- 506 soporte motor delantero izquierdo
- 4- 389 soporte motor trasero
- 5- 360 silentbloc trapecio inferior
- 6- 828 abrazadera goma central barra estabilizadora
- 7- 466 goma puntal barra estabilizadora (Ø 22 mm)
- 8- 827 abrazadera goma puntal barra estabilizadora
- 9- 469 goma central barra estabilizadora
- 10- 4148 tapa superior amortiguador
- 11- 4147 goma apoyo amortiguador delantero
- 12- 4178 rodamiento superior amortiguador
- 13- 4152 capuchón con tope de goma
- 14- 90015 buje rueda delantera
- 15- 96078 latiguillo freno delantero

**SUSPENSION TRASERA**

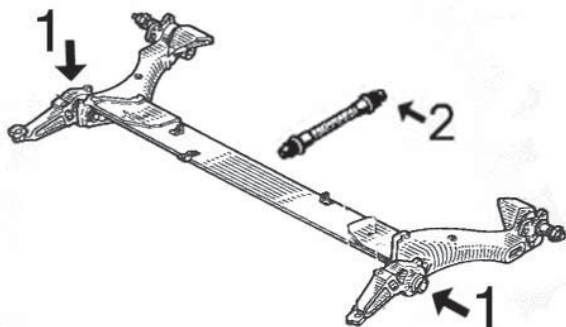

- 1- 784 silentbloc interior soporte puente trasero
- 2331 silentbloc exterior soporte puente trasero
- 2- 96161 latiguillo freno trasero R-9/11
- 96065 latiguillo freno trasero SUPER5



## RENAULT 9 - 11 - SUPER 5







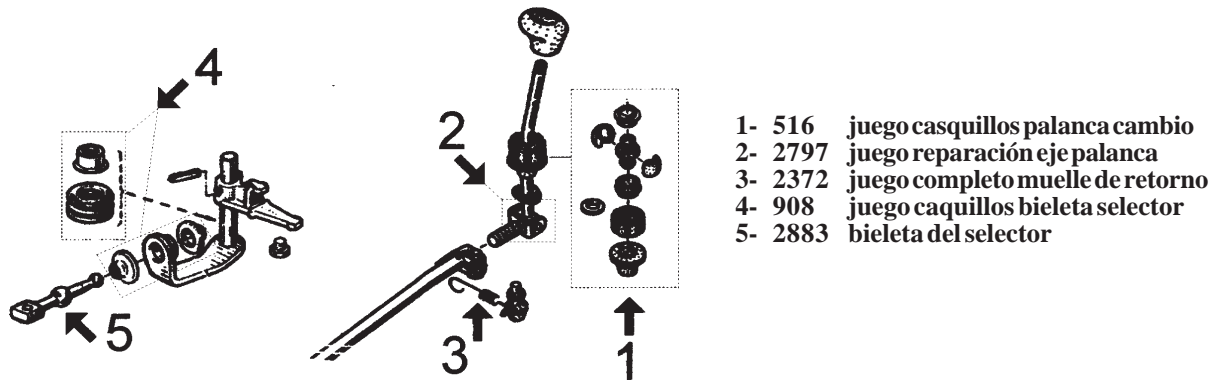

 <p><b>360</b> silentbloc trapecio inferior delantero r.o. 7700762574 (12x32x46x36)</p>	 <p><b>445</b> goma puntal barra R-9/11 hasta modelo '84 r.o. 7700693154</p>	 <p><b>466</b> <span style="float: right;">Ø 22 mm</span> goma puntal barra estabilizadora d/'84 r.o. 7700760264</p>
 <p><b>468</b> <span style="float: right;">Ø 21 mm</span> goma puntal barra estabilizadora d/'84 r.o. 7700760265</p>	 <p><b>827</b> abrazadera goma puntal barra estabilizad. r.o. 7700680098</p>	 <p><b>828</b> abrazadera goma central barra estabiliz. r.o. 7700789817</p>
 <p><b>469</b> goma central barra estabilizadora r.o. 7702144561</p>	 <p><b>387</b> soporte de motor derecho r.o. 7704001318</p>	 <p><b>388</b> soporte de motor izquierdo r.o. 7704001320</p>
 <p><b>481</b> soporte motor izqdo R-9/11 GTX-TXE y SUPER5 GTX-90, r.o. 7700755531</p>	 <p><b>389</b> soporte motor trasero todos modelos r.o. 7704001319</p>	 <p><b>506</b> soporte motor delt. izqdo. SUPER-5 D r.o. 7700770307</p>
 <p><b>504</b> soporte motor lateral izqd. SUPER 5 Diesel r.o. 7700770479</p>	 <p><b>508</b> soporte motor derecho SUPER 5 Diesel r.o. 7700770480</p>	 <p><b>787</b> goma muelle suspensión delantera R-9/11 r.o. 7700757324</p>
 <p><b>784</b> silentbloc brazo suspensión trasera r.o. (43x72x28x28)</p>	 <p><b>2331</b> silentbloc brazo suspensión trasera r.o. (43x72x36x36)</p>	 <p><b>4147</b> soporte goma amortg. delantero Súper5 r.o. 7700757324</p>
 <p><b>4148</b> chapa tapa superior amortg. delantero r.o.</p>	 <p><b>4152</b> fuelle amortiguador delantero Súper5 r.o. 7700757323</p>	 <p><b>4173</b> fuelle amortiguador delantero R-9/11 r.o. 7700776743</p>

## RENAULT 9 - 11 - SUPER 5

 <b>4178</b> rodamiento soporte amortiguador delantero r.o. 7700797666-7700777654	 <b>90015</b> buje rueda delantera r.o. 7700719140	 <b>96064</b> latiguillo freno delantero R9-R11 (374 mm) r.o. 7704001954
 <b>96078</b> latiguillo freno delantero Super5 (333 mm) r.o. 7704003913	 <b>96161</b> latiguillo freno trasero R9-R11 (270 mm) r.o. 7704003549	 <b>96065</b> latiguillo freno trasero Super5 (305 mm) r.o. 7704003905

### ARTICULACIONES PALANCA DE CAMBIO todos modelos:



 <b>516</b> juego casquillos palanca de cambio r.o. 7700464111	 <b>908</b> juego casquillos bieleta selector velocidades r.o. 7703087115+7700679960+7700703000	 <b>2372</b> jgo muelle retorno palanca con casquillos r.o. 7701468199
 <b>2797</b> juego reparación eje pasador palanca de cambio, r.o. no hay despiece	 <b>2883</b> bieleta selector de velocidades completa r.o. 7700875584+7700872205+7700743133	 <b>4036</b> bomba manual cebado gasoil r.o.
 <b>4297</b> horquilla embrague completa r.o. 770725720	 <b>350 fuelle</b> <b>1350 kit</b> fuelle cremallera dirección r.o. 7700678649	 <b>444</b> casquillo cremallera dirección r.o. 7704000926

# RENAULT 9 - 11 - SUPER 5



**2849**  
polea cigüeñal Diesel **6 canales**  
r.o. 7700112999(7700724249)



**498**  
serreta pedal embrague completa  
r.o. 7700679621



**670**  
tapón cárter de aceite  
r.o. 7903075033



**352**  
nuez articulación barra dirección  
r.o. 7700687433



**1274E**  
kit rep. transm. l/rda **para montar en cono**  
(en neopreno especial de elasticidad 800%)

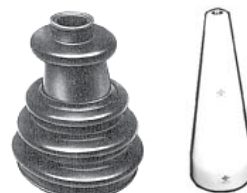

**1273E**  
kit rep. transm. l/rda **para montar en cono**  
(en neopreno especial de elasticidad 800%)



**1557E**  
kit rep. tr. l/rda **para montar en cono**  
(en neopreno especial elasticidad 800%)



**339**  
fuelle transmisión corta l/cambio  
sin rodamiento, r.o.



**1367**  
kit rep. transmisión larga lado cambio  
(caña ancha), r.o. 7701462101



**1537** (rodamiento Ø 25.8 mm)  
kit reparación transmissi. corta l/cambio  
completo con rodamiento, r.o. 7701462100



**1763** (rodamiento Ø 23.8 mm)  
kit reparación transmissi. corta l/ cambio  
SUPER 5 Diesel, r.o. 7701464129



**1562** (rodamiento Ø22.8 mm)  
kit reparación transm. corta l/cambio  
SUPER 5 DIESEL, r.o. 7701463955



**1626**  
kit rep. transm. larga l/cbo caña estrecha  
r.o. 7701450617

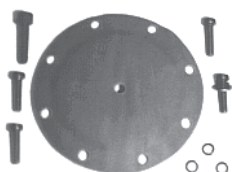

**832**  
jgo reparación membrana depresor Diesel  
r.o.

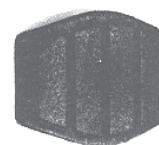

**417**  
cubrepedal freno y embrague  
r.o. 7700680386



**280**  
soporte tubo de escape R-9/11  
r.o. 7700686449



**281**  
soporte tubo de escape R-9/11  
r.o. 7700677773



**584**  
soporte tubo de escape SUPER 5  
r.o. 7700779356



**2381** Ø 52 mm  
junta cónica colector de escape  
r.o. 7700797807



**2382** Ø 73 mm  
junta cónica colector de escape  
r.o. 7700766353



**748**  
collarín empalme tubo de escape Ø 66 m  
r.o. 7701459194

## RENAULT 12 - 14



**5636**  
mgto superior radiador R-12, R-12 S  
r.o. 7700537597-7700521706



**5637**  
mgto inferior radiador R-12, R-12 S  
r.o. 7700537799-7700517359

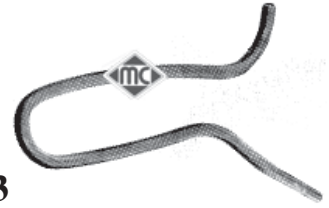

**5593**  
mgto derecho calefactor R-12  
r.o. 7700516244



**5594**  
mgto izquierdo calefactor R-12  
r.o. 7700522929



**958**  
purgador pequeño  
r.o. 7700519230



**3692**  
tapón de radiador (metálico)  
r.o. 7701018380-085364700

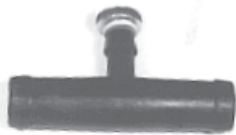

**971**  
purgador grande  
r.o. 7701461001



**210**  
flector de dirección  
r.o. 7700549015



**760**  
rollo 15 mts. tubo de agua sobrante de  
botella a radiador Ø 6x10 mm.



**263**  
fuelle cremallera dirección R-14  
r.o. 7702118974



**1263-C**  
kit reparación cremallera completo R-14  
r.o.



**287**  
juego casquillos cremallera  
r.o. 7700542611



**152**  
dado articulación barra dirección  
r.o. 7700523095

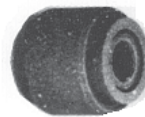

**172**  
silentbloc punta cremallera dirección R-12  
r.o. 7700509247

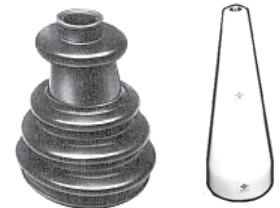

**1273-E**  
kit rep trans l/rda **para montar con cono**  
(en neopreno especial elasticidad 800%)



**1273 kit**                      **273 fuelle**  
kit reparación transmisión lado rueda  
r.o. 7701457539



**1272**  
kit reparación transmisión l/cambio R-12  
r.o. 7701013273



**1556**  
kit reparación transm l/cambio comple-  
to con soporte metálico R-14, 7701459950

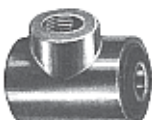

**211**  
silentbloc soporte inferior amortg. delt. R-12  
r.o. 7701348300

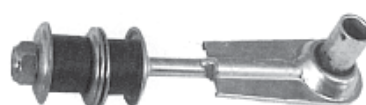

**178**  
bioleta barra estabilizadora R-12  
r.o. 7701453465

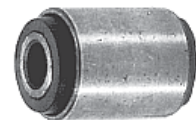

**169**  
silentbloc trapecio inferior delantero R-12  
r.o. 7700514109 (14x32x38x46)



## RENAULT 12 - 14



**199**  
silentbloc tirante susp. delantera R-12  
r.o. 7700547187



**416**  
cubrepedal freno y embrague  
r.o. 7700651253



**164**  
goma bieleta barra estabilizadora R-12  
r.o. 0608094100 (Ø 9x15 - 20)



**193**  
silentbloc trapecio central puente trasero  
r.o. 7701348562

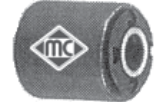

**454**  
silentbloc extremo brazo delantero R-14  
r.o. (10x28x28x34)



**875** poliuretano  
silentbloc tirante brazo delantero R-14  
r.o. 7701348547

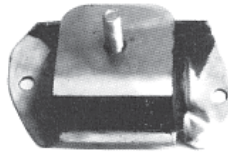

**248**  
soporte dcho. e izqdo. motor R-12  
r.o. 7700504950

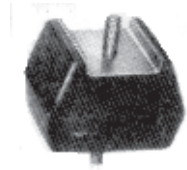

**168**  
soporte cambio R-12  
r.o. 7700506311



**212**  
soporte palanca de cambio R-12  
r.o. 7700575465



**162**  
soporte silenciador trasero R-12  
r.o. 7700518505



**262**  
soporte silenciador trasero R-14  
r.o. 7700655644

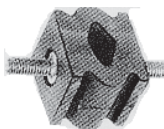

**205**  
soporte tubo de escape R-14  
r.o. 7700632015



**167**  
soporte tubo de escape R-12 (rosca M-10)  
r.o. 7700523095



**90097**  
bujes rueda delantera R-12  
r.o.

## RENAULT 18



**7481**  
mgto superior radiador GTL-GTS  
r.o. 7700651584



**7587**  
mgto superior radiador DIESEL y GTX  
r.o. 7704001409



**7588**  
mgto inferior radiador DIESEL y GTX >'84  
r.o. 7704001338



**7554**  
mgto de purgador a tubo DIESEL y GTX  
r.o. 7704001407



**7555**  
mgto de grifo a culata DIESEL y GTX  
r.o. 7704001355



**3692**  
tapón radiador  
r.o. 7701018380



**7998**  
mgto de bomba de agua a tubo DIESEL  
r.o. 7705026323



**7999**  
mgto de termostato a bomba DIESEL  
r.o. 7700661636



**8128**  
mgto desvaporizador DIESEL  
r.o. 7700733557



**3501**  
botella de expansión GTS  
r.o. 7701203249



**3500**  
botella de expansión Diesel y GTX  
r.o. 7701203218

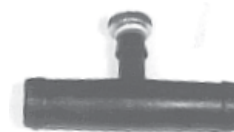

**971**  
purgador circuito agua todos modelos  
r.o. 7701461001



**3033**  
boquilla en culata DIESEL y GTX  
r.o. 7700639062



**3514**      1,2 bar-cápsula marrón  
tapón de botella de expansión  
r.o.



**3525**      1,4 bar-cápsula celeste  
tapón de botella de expansión  
r.o.

## SUSPENSION DELANTERA Y TRASERA, todos los modelos:

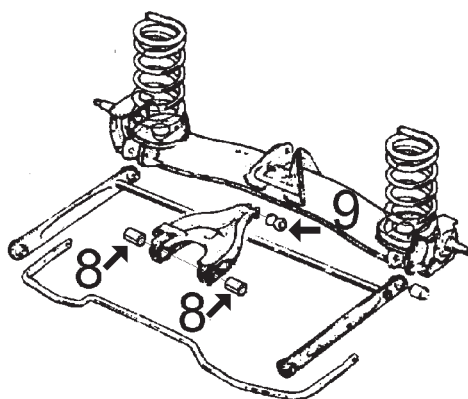
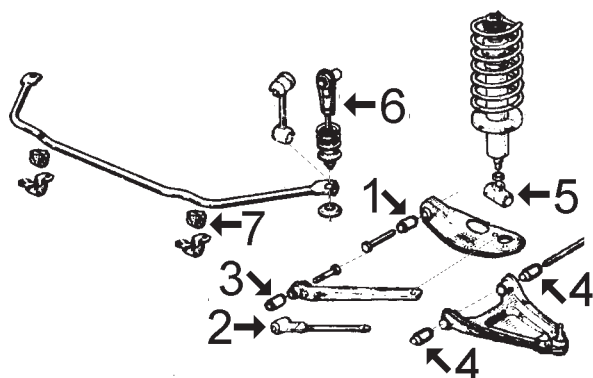

- 1- n/d silentbloc brazo superior hasta mod. '82
- n/d silentbloc brazo superior desde mod. '82
- 2- n/d tirante brazo delantero, hasta mod. '82
- 3- n/d silentbloc tirante brazo delantero desde '82
- 4- 169 silentbloc trapecio inferior hasta mod. '82
- 461 silentbloc trapecio inferior desde mod. '82

- 5- 211 silentbloc soporte amortiguador delantero
- 6- 178 bieleta barra estabilizadora hasta mod. '82
- 495 bieleta barra estabilizadora desde mod. '82
- 7- 166 goma barra estabilizadora
- 8- n/d silentbloc trapecio puente trasero
- 9- 193 silentbloc punta trapecio puente trasero

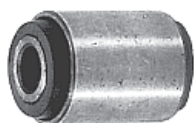

**169**  
silentbloc trapecio inf. delantero hasta '82  
r.o. 7704001599 (14x32x46x38)

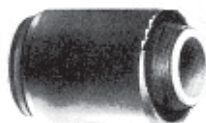

**461**  
silentbloc trapecio inf. delantero desde '82  
r.o. 7704001281 (14x36x38x53)



**211**  
silentbloc soporte amortiguador delantero  
r.o. 7701348300



**166**  
goma barra estabilizadora  
r.o. 7700630430



**193**  
silentbloc punta trapecio trasero  
r.o. 7704001036



**164**  
goma bieleta barra estabilizadora  
r.o. 0608094100 (9x15x20)



**178**  
bieleta barra estabilizadora hasta '82  
r.o. 7701453465



**495**  
bieleta barra estabilizadora desde '82  
r.o. 7700710718



**90033**  
buje de rueda delantera  
r.o. 7700715149



**90527**  
buje de rueda trasera con rodamiento  
r.o. 7701204667



**212**  
soporte palanca de cambio hasta '82  
r.o. 7703034008

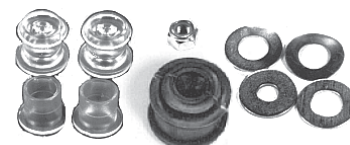

**907**  
juego casquillos palanca cambio desde '82  
r.o. 7700689713+7700692252

# RENAULT 18



**2850**  
polea cigüeñal Diesel (motor 2068cc)  
r.o. 7700853470



**152**  
cruceta barra dirección  
r.o.



**1265**  
fuelle cremallera dirección manual  
r.o. 7700653459

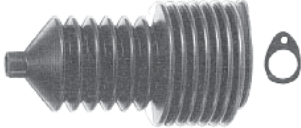

**561**  
fuelle cremallera asistida  
r.o. 7700781095

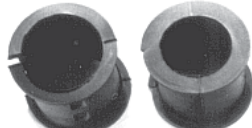

**2316**  
juego gomas sujeción cremallera asistida  
r.o. 7700778304+7700662571



**1266**  
fuelle dcho. cremall. asistida (según vers.)  
r.o. 7700680582



**1274E**  
kit rep transm l/rda **para montar con cono**  
r.o.



**1273E**  
kit rep. transm. l/rda **para montar en cono**  
r.o. 7701348568



**525**  
soporte de motor GTL-GTS-TURBO desde modelo '82, r.o. 7704000469



**496**  
soporte delantero motor DIESEL y GTX  
r.o. 7704000829

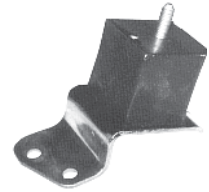

**484**  
soporte izquierdo motor DIESEL y GTX  
r.o. 7704000769

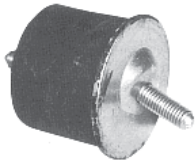

**426**  
soporte derecho motor DIESEL y GTX  
r.o. 7704000767

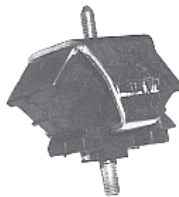

**716**  
soporte trasero motor DIESEL y GTX  
r.o. 7704000777



**96072**  
latiguillo freno delantero (290 mm)  
r.o. 7701394336

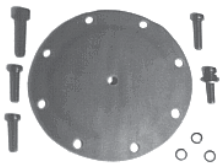

**832**  
juego reparación depresor (DIESEL)  
r.o.



**262**  
soporte silenciador trasero  
r.o. 7700655644



**309**  
funda goma muelle suspensión  
R.O.



**240**  
soporte tubo de escape (rosca M-8)  
r.o. 7700565762



**667**  
tapon cárter aceite  
r.o.

rosca 16/150



**668**  
tapon cárter aceite  
r.o.

rosca 18/150



## CANALIZACIONES DE AGUA

**R-19 1.4 motor C1J de 1.397 cc (1988-1989)**

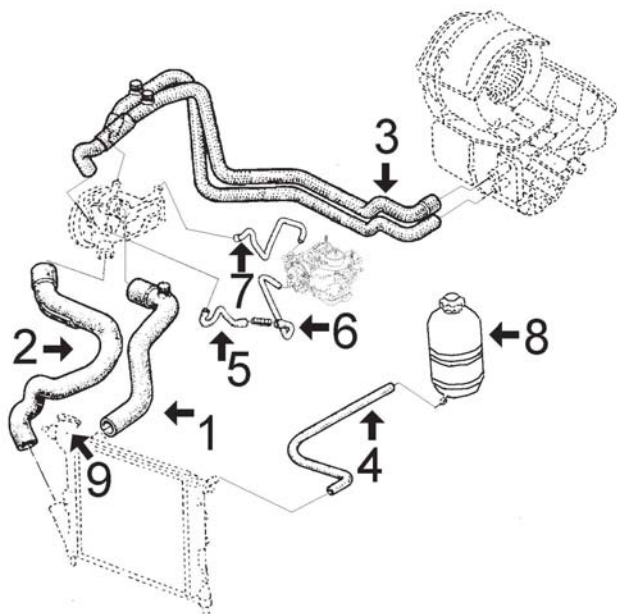

- 1- 7516 mgto superior radiador
- 2- 8457 mgto inferior radiador
- 3- 8422 mgto doble de calefacción
- 4- 760 mgto de botella a radiador. Cortar de rollo MC-760 6x11 mm
- 5- 7969 mgto de bomba a carburador, 1er. tramo
- 6- 7970 mgto de bomba a carburador, 2º tramo
- 7- 7671 mgto de carburador a bomba
- 8- 3501 botella de expansión  
3519 tapón de botella 0,70 bar  
3514 tapón de botella 1,20 bar
- 9- 3692 tapón de radiador (metálico)

**R-19 1.4 "energy" motores E6J (carburador) y E7J (inyección) desde '89**

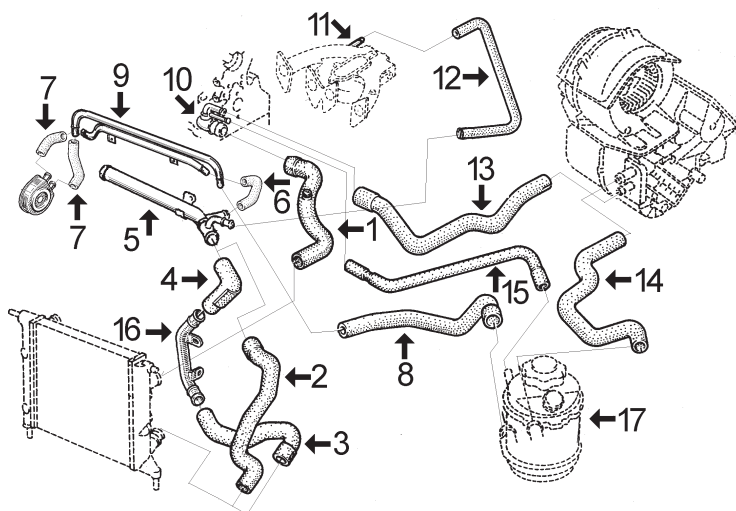

- 1- 7831 mgto superior radiador sin aire acondicionado  
8472 mgto superior radiador con aire acondicionado
- 2- 7850 mgto inferior radiador sin aire acondicionado
- 3- 8106 mgto inferior radiador 1er. tramo, con aire ac.
- 4- 8105 mgto inferior de radiador 2º tramo, con aire ac.
- 5- 3001 tubo de agua metálico
- 6- 7966 mgto enlace tubos metálicos
- 7- 7971 juego dos mgtos intercambiador
- 8- 7911 mgto de tubo metálico doble a botella
- 9- 3003 tubo de agua metálico doble (se suministra con el jgo. de mgtos. a intercambiador nº7)
- 10- 3173 cuerpo de termostato  
3116 tapa de termostato  
2404 junta de termostato
- 11- 3010 boquilla clavada en colector de admisión
- 12- 7907 mgto de tubo metálico a boquilla en colector
- 13- 7908 mgto de calefactor a boquilla en termostato
- 14- 7909 mgto de calefactor a botella
- 15- 7905 mgto de botella a boquilla en termostato
- 16- 3112 tubo de agua metálico sólo versiones con aire ac.
- 17- 3500 botella de expansión  
3514 tapón de botella 1,20 bar  
3525 tapón de botella 1,40 bar

R-19 1.7 GTX-TXE motor F2N de 1.721 cc (carburador) hasta '91

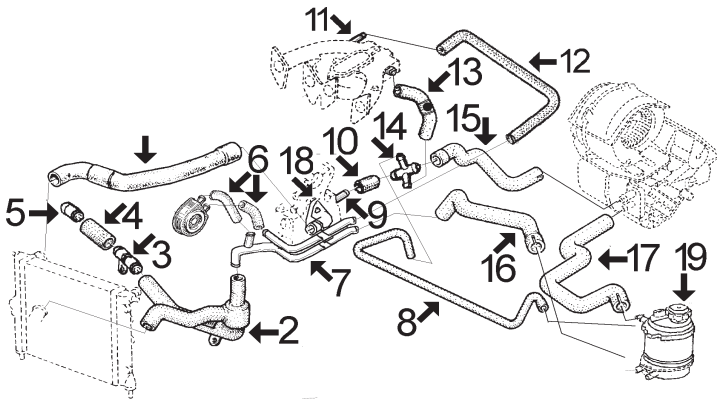

- 1- 7852 mgto superior radiador
- 2- 7851 mgto inferior radiador sin aire acondicionado  
8058 mgto inferior radiador con aire acondicionado
- 3- 3030 boquilla enlace mgto inferior, con aire acondic.
- 4- 8114 mgto a boquilla entrada a bloque, con aire acond.
- 5- 3004 boquilla entrada agua a bloque
- 6- 8115 juego dos mgtos a intercambiador
- 7- 3009 tubo metálico doble
- 8- 8109 mgto de botella a racor 4 vias
- 9- 3033 boquilla clavada en culata
- 10- 8098 mgto de boquilla en culata a racor 4 vias
- 11- 3050 boquilla clavada en colector de admisión
- 12- 8113 mgto de tubo metálico a boquilla en colector
- 13- 8112 mgto de racor 4 vias a colector admisión
- 14- 3016 racor 4 vias
- 15- 8108 mgto de calefactor a racor 4 vias
- 16- 8693 mgto de botella a tubo metálico
- 17- 7909 mgto de calefactor a botella
- 18- 3117 tapa de termostato  
2362 junta de termostato
- 19- 3500 botella de expansión  
3525 tapón de botella 1,40 bar

R-19 1.8 TXI motor F3N de inyección, desde '91  
(tipos 53B - 53C - 53E - 53F y 53M)

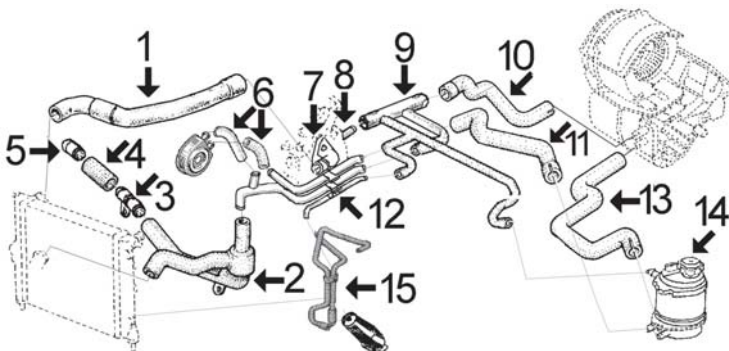

- 1- 8208 mgto superior radiador
- 2- 7851 mgto inferior radiador sin aire acondicionado  
8110 mgto inferior radiador con aire acondicionado
- 3- 3030 boquilla enlace mgto inferior, con aire acondic.
- 4- 8114 mgto a boquilla entrada a bloque, con aire acond.
- 5- 3004 boquilla entrada agua a bloque
- 6- 8115 juego dos mgtos a intercambiador
- 7- 3115 tapa de termostato  
2362 junta de termostato
- 8- 3033 boquilla metálica en culata
- 9- 8271 mgto multisalida a culata, botella y empalme, ver-  
siones con aire acondicionado  
8694 mgto multisalida a culata, botella y empalme, ver-  
siones sin aire acondicionado hasta '92  
8271 mgto multisalida a culata, botella y empalme, ver-  
siones sin aire acondicionado desde '92
- 10- 8441 mgto de calefactor a mgto multisalida
- 11- 8454 mgto de tubo metálico a botella
- 12- 3074 tubo de agua metálico
- 13- 8433 mgto de calefactor a botella
- 14- 3500 botella de expansión  
3525 tapón de botella 1,40 bar
- 15- 8687 mgto de tubo metálico a bomba de recirculación

R-19 1.8 TXI motor F3P de inyección, tipo 53Y

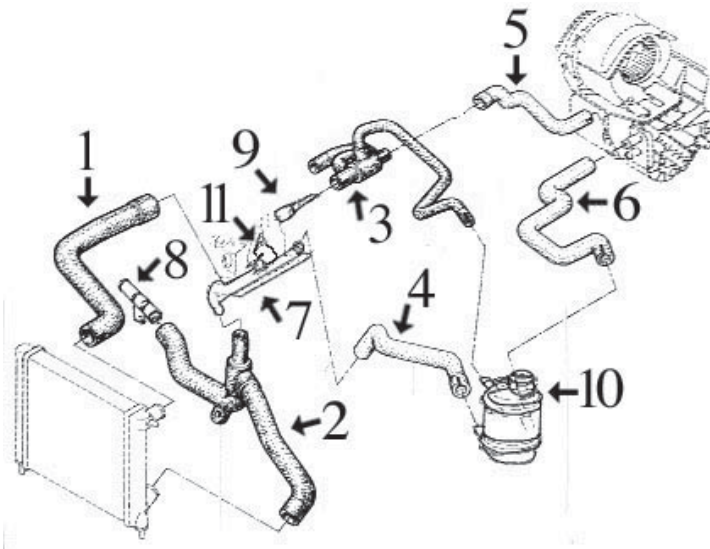

- 1- 7852 mgto superior radiador sin aire acondicionado
- 7830 mgto superior radiador con aire acondicionado hasta 2/94
- 7852 mgto superior radiador con aire acondicionado desde 2/94
- 2- 8667 mgto inferior radiador sin aire acondicionado
- 8110 mgto inferior radiador con aire acondicionado, 1er. tramo
- 8114 mgto inferior radiador con aire acondicionado, 2º tramo
- 3- 8697 mgto de culata a mgto de calefactor y botella
- 4- 8693 mgto de tubo metálico a botella
- 5- 8108 mgto de calefactor a mgto de culata
- 6- 7909 mgto de calefactor a botella
- 7- 3145 tubo de agua metálico
- 8- 3004 tubo metálico clavado en bloque, verisiones sin aire acondicionado
- 3030 tubo de agua metálico empalme 1er. y 2º tramo mgto inferior, versiones con aire acondicionado
- 9- 3033 boquilla metálica en culata
- 10- 3500 botella de expansión
- 3525 tapón de botella 1,40 bar
- 11- 3117 tapa de termostato
- 2362 junta de termostato

R-19 1.8 TXI motor F3P de inyección, tipo 53V ("RTi")

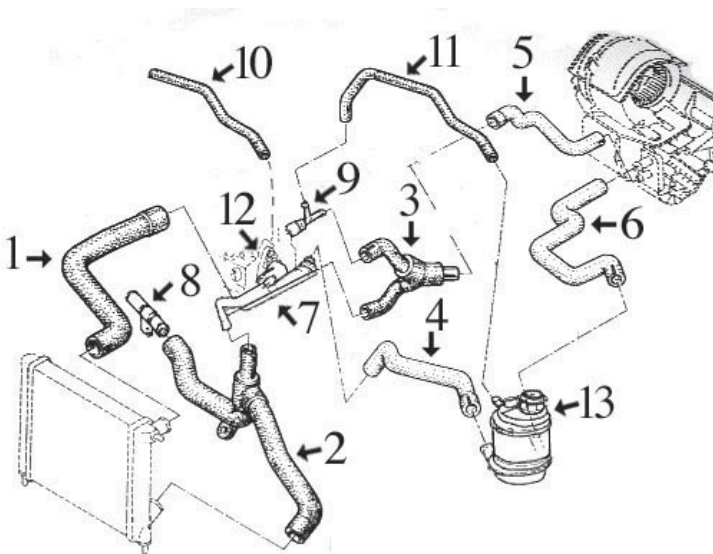

- 1- 7852 mgto superior radiador sin aire acondicionado
- 7830 mgto superior radiador con aire acondicionado hasta 2/94
- 7852 mgto superior radiador con aire acondicionado desde 2/94
- 2- 8667 mgto inferior radiador sin aire acondicionado
- 8110 mgto inferior radiador con aire acondicionado, 1er. tramo
- 8114 mgto inferior radiador con aire acondicionado, 2º tramo
- 3- 8699 mgto de culata a calefactor (juego 2 mgtos con nº 5)
- 4- 8698 mgto de tubo metálico a botella
- 5- 8699 mgto de culata a calefactor (juego 2 mgtos con nº 3)
- 6- 7909 mgto de calefactor a botella
- 7- 3145 tubo de agua metálico
- 8- 3004 tubo metálico clavado en bloque, verisiones sin aire acondicionado
- 3030 tubo de agua metálico empalme 1er. y 2º tramo mgto inferior, versiones con aire acondicionado
- 9- 3029 boquilla metálica en culata
- 10- 8705 mgto de tubo metálico a colector
- 11- 8688 mgto de boquilla en culata a botella
- 12- 3117 tapa de termostato
- 2362 junta de termostato
- 13- 3500 botella de expansión
- 3525 tapón de botella 1,40 bar

## R-19 DIESEL hasta '92

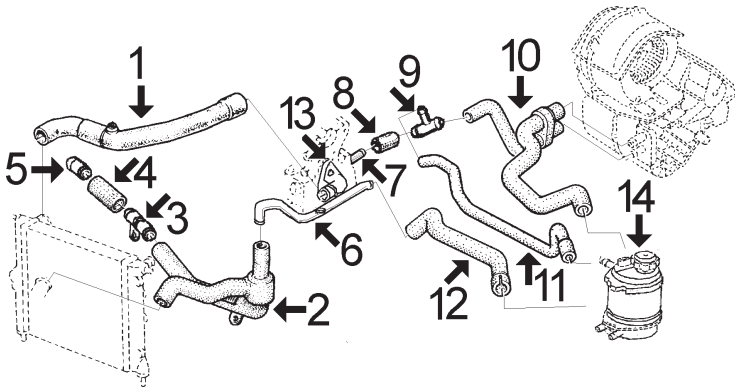

- 1- 7830 mgto superior de radiador
- 2- 8111 mgto inferior de radiador
- 3- 3030 boquilla enlace mgto inferior, con aire acond.
- 4- 8114 mgto a boquilla entrada agua, con aire acond.
- 5- 3004 boquilla entrada agua a bloque
- 6- 3062 tubo de agua metálico
- 7- 3033 boquilla clavada en culata
- 8- 8098 mgto de boquilla en culata a racor 3 vias
- 9- 3046 racor 3 vias
- 10- 8121 mgto doble de calefactor a botella y racor 3 vias
- 11- 8118 mgto de botella a racor 3 vias
- 12- 8117 mgto de botella a tubo metálico
- 13- 3117 tapa de termostato
- 2362 junta de termostato
- 14- 3500 botella de expansión
- 3525 tapón de botella 1,40 bar

- 8665 mgto desvaporizador
- 8666 mgto desvaporizador

## R-19 DIESEL desde '92

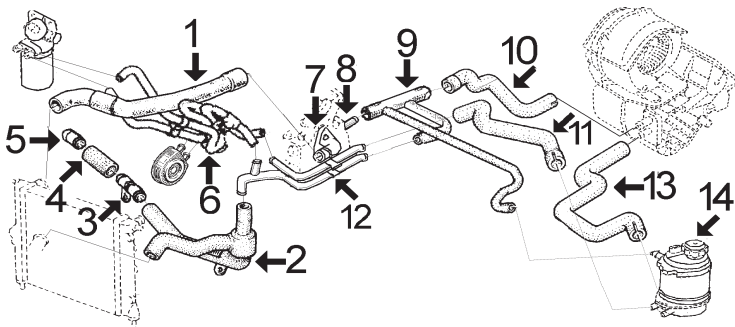

- 1- 7830 mgto superior radiador
- 2- 8111 mgto inferior radiador
- 3- 3030 boquilla enlace mgto inferior, con aire acond.
- 4- 8114 mgto a boquilla entrada agua, con aire acond.
- 5- 3004 boquilla entrada agua a bloque
- 6- 8370 mgto multisalida de tubo metálico a intercambiador y a filtro de gasoil
- 7- 3117 tapa de termostato
- 2362 junta de termostato
- 8- 3033 boquilla en culata
- 9- 8432 mgto de culata a tubo metálico y a botella
- 10- 8108 mgto de calefactor a empalme mgto de culata
- 11- 8117 mgto de tubo metálico a botella
- 12- 3110 tubo de agua metálico
- 13- 7909 mgto de calefactor a botella
- 14- 3500 botella de expansión
- 3525 tapón de botella 1,40 bar

- 8665 mgto desvaporizador
- 8666 mgto desvaporizador

## R-19 TURBODIESEL (tipos 53K, 53T y 53Z)

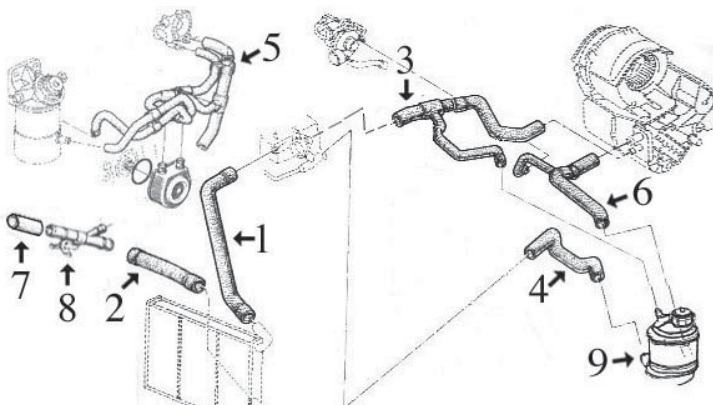













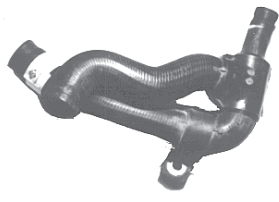



- 1- 8703 mgto superior radiador
- 2- 8696 mgto inferior radiador
- 3- 8701 mgto de caja termostato a calefactor y botella
- 4- 8700 mgto de caja termostato a botella
- 5- 8707 mgto doble de caja termostato a intercambiador y filtro de gasoil, versiones sin aire acondicionado
- 8708 mgto de caja termostato a tubo metálico, versiones con aire acondicionado
- 6- 8702 mgto 3 vias de calefactor a botella
- 7- 8114 mgto de tubo metálico a bloque
- 8- 3144 tubo de agua metálico de mgto inferior a bloque
- 9- 3500 botella de expansión
- 3525 tapón de botella 1,40 bar



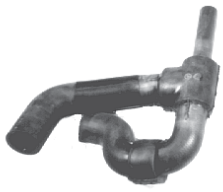









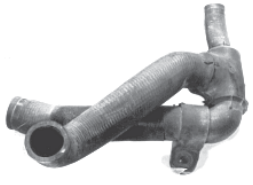







- 8704 juego mgto desvaporizadores



## RENAULT 19

 <p><b>7516</b> mgto superior radiador 1.4 hasta '89 r.o. 7700760872</p>	 <p><b>7671</b> mgto de carburador a bomba 1.4 hasta '89 r.o. 7700726561</p>	 <p><b>7830</b> mgto superior radiador Diesel r.o. 7700793247</p>
 <p><b>7831</b> mgto superior radiador 1.4 desde '89 sin aire acondicionado, r.o. 7700790231</p>	 <p><b>7850</b> mgto inferior radiador 1.4 sin aire acond. r.o. 7700793617</p>	 <p><b>7851</b> mgto inferior radiador 1.7-1.8 sin aire ac. r.o. 7700796216</p>
 <p><b>7852</b> mgto superior radiador 1.7 r.o. 7700806237</p>	 <p><b>7905</b> mgto de botella a termostato 1.4 r.o. 7700791142</p>	 <p><b>7907</b> mgto de tubo metálico a colector 1.4 r.o. 7700741327</p>
 <p><b>7908</b> mgto de calefactor a termostato 1.4 r.o. 7700790237</p>	 <p><b>7909</b> mgto de calefactor a botella 1.4 y 1.7 r.o. 7700787607</p>	 <p><b>7911</b> mgto de tubo metálico a botella 1.4 r.o. 7700792372</p>
 <p><b>7966</b> mgto unión tubos metálicos 1.4 r.o. 7700745411</p>	 <p><b>7969</b> mgto de bomba a carburador 1.4 hasta '89 r.o. 7700739814</p>	 <p><b>7970</b> mgto de bomba a carburador 1.4 hasta '89 r.o. 7700739813</p>
 <p><b>7971</b> juego mgto intercambiador 1.4 r.o. 7700744963+7700271213</p>	 <p><b>8058</b> mgto inferior radiador 1.7 y 16v con aire ac. r.o. 7700795304</p>	 <p><b>8098</b> mgto de culata a racor 1.7 r.o. 7700742500</p>
 <p><b>8105</b> mgto inferior radiador (2º tramo) 1.4 con aire acond., r.o. 7700796066</p>	 <p><b>8106</b> mgto inferior radiador (1er. tramo) 1.4 con aire acond., r.o. 7700793248</p>	 <p><b>8108</b> mgto de calefactor a racor 1.7 r.o. 7700787604</p>

## RENAULT 19

 <p><b>8109</b> mgto de botella a racor 4 vias 1.7 r.o. 7700793246</p>	 <p><b>8110</b> mgto inferior radiador 1.8 aire ac. r.o. 7700795303-7700271097</p>	 <p><b>8111</b> mgto inferior radiador Diesel r.o. 7700794159</p>
 <p><b>8112</b> mgto de racor a colector 1.7 r.o. 7700851307</p>	 <p><b>8113</b> mgto de tubo metálico a colector 1.7 r.o. 7700743470</p>	 <p><b>8114</b> mgto a boquilla en bloque 1.7-1.8-D r.o. 7705226020</p>
 <p><b>8115</b> juego de mgto intercambiador 1.7-1.8 r.o. 7700742233+7700742234</p>	 <p><b>8117</b> mgto de botella a tubo metálico Diesel r.o. 7700794947</p>	 <p><b>8118</b> mgto de botella a racor 3 vias Diesel r.o. 7700807287</p>
 <p><b>8121</b> mgto doble de calefactor Diesel r.o. 7700791143-7700805123</p>	 <p><b>8208</b> mgto superior radiador 1.8 r.o. 7700271052-7700271135</p>	 <p><b>8271</b> mgto de culata a botella y empalme 1.8 r.o. 7700271112</p>
 <p><b>8370</b> mgto de tubo a intercambiador y filtro gas-oil Diesel desde '92, r.o. 7700864972</p>	 <p><b>8422</b> mgto doble de calefactor 1.4 hasta '89 r.o. 7700787608</p>	 <p><b>8432</b> mgto de culata a tubo y botella Diesel desde '92, r.o. 7700816064</p>
 <p><b>8433</b> mgto de calefactor a botella 1.8 r.o. 7700271053</p>	 <p><b>8441</b> mgto de tubo metálico a calefactor 1.8 r.o. 7700271120</p>	 <p><b>8454</b> mgto de tubo metálico a botella 1.8 r.o. 7700271054</p>
 <p><b>8457</b> mgto inferior radiador 1.4 hasta '89 r.o. 7700790240</p>	 <p><b>8472</b> mgto superior radiador 1.4 desde '89 con aire acondicionado, r.o. 7700793249</p>	 <p><b>8665</b> mgto desvaporizador 1.9 Diesel r.o.</p>

## RENAULT 19



**8666**  
mgto desvaporizador 1.9 Diesel  
r.o.



**8667**  
mgto inferior radiador 1.8i  
r.o.



**8687**  
mgto de tubo a bomba recirculación 1.8i  
r.o.7700271269



**8688**  
mgto de botella a boquilla en culata 1.8i  
r.o.7700819833



**8693**  
mgto de botella a tubo metálico 1.7-1.8i  
r.o.7700787605



**8694**  
mgto de culata a botella y empalme  
r.o.



**8696**  
mgto inferior radiador TurboD  
r.o.



**8697**  
mgto de culata a botella y calefactor 1.8i  
r.o.



**8698**  
mgto de tubo a botella 1.8i  
r.o.



**8699**  
mgto de culata a calefactor 1.8i (juego 2  
tramos), r.o.



**8700**  
mgto de botella a caja termostato TurboD  
r.o.



**8701**  
mgto de calefactor a culata TurboD  
r.o.



**8702**  
mgto de calefactor a botella TurboD  
r.o.



**8703**  
mgto superior radiador TurboD  
r.o.

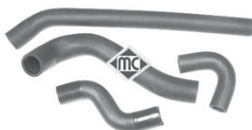

**8704**  
juego mgts desvaporizadores TurboD  
r.o.



**8705**  
mgto de tubo metálico a colector 1.8i  
r.o.

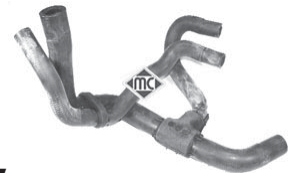

**8707**  
mgto de caja termostato a intercambiador  
y tubo metálico TurboD, r.o.



**8708**  
mgto de caja termostato a tubo metálico  
TurboD aire ac., r.o.

## RENAULT 19



**3001**  
tubo de agua metálico 1.4 desde '89  
r.o. 7700859397+7703065210



**3003 incluye mgts. intercambiador**  
tubo de agua metálico 1.4 desde '89  
r.o. 7700271212+7700271213+7700744963



**3004**  
boquilla entrada agua a bloque 1.7-1.8 y D  
r.o. 7700860014



**3009**  
tubo de agua metálico 1.7  
r.o. 7700860374



**3010**  
boquilla en colector de admisión 1.4  
r.o. 7705030338



**3016**  
racor plástico 4 vias 1.7  
r.o.

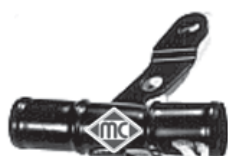

**3030**  
tubo enlace mgto inferior 1.7-1.8 y Diesel  
r.o. 7700860405



**3033**  
boquilla en culata 1.7-1.8 y Diesel  
r.o. 7705030135 - 7700861225



**3046**  
racor 3 vias Dese  
r.o. 7705030028

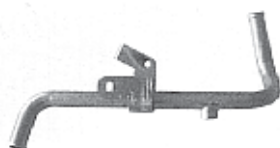

**3062**  
tubo de agua metalico Diesel hasta '92  
r.o. 7700742244

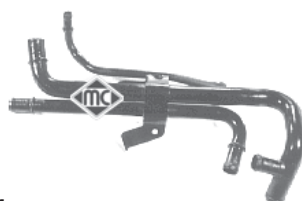

**3074**  
tubo de agua metálico 1.8  
r.o. 7700272259



**3110**  
tubo de agua metálico Diesel desde '92  
r.o. 7700860376



**3112**  
tubo de agua metálico 1.4 con aire acond.  
r.o. 7700796067



**3115**  
tapa de termostato 1.8  
r.o. 7700726976



**3116**  
tapa de termostato 1.4 desde '89  
r.o. 7700738110



**3117**  
tapa de termostato 1.7-1.8 y Diesel  
r.o. 7700851979



**3144**  
tubo de agua metálico TurboDiesel  
r.o. 7700854340

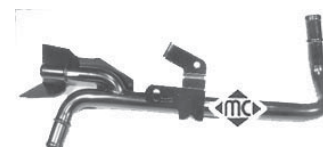

**3145**  
tubo de agua metálico 1.8i (F3P)  
r.o. 7700860446











**¡NUEVO!**



**3173**  
caja de termostato 1.4 "Energy"  
r.o. 7700272358



## RENAULT 19

 <p><b>2362</b> junta de termostato 1.4 r.o. 7700718380</p> <p style="text-align: right;">Ø 47 x 55</p>	 <p><b>2404</b> junta de termostato 1.7-1.8 y Diesel r.o. 7700741923</p> <p style="text-align: right;">Ø 44 x 52</p>	 <p><b>3501</b> botella de expansión 1.4 hasta '89 r.o. 7701203249</p>
 <p><b>3500</b> botella de expansión 1.4 desde '89, 1.7-1.8 16v y Diesel, r.o. 7701203218</p>	 <p><b>3519</b>                      <b>0,70 bar-blanco</b> tapón botella de expansión r.o.</p>	 <p><b>3514</b>                      <b>1,20 bar-marrón</b> tapón de botella de expansión r.o.</p>
 <p><b>3525</b>                      <b>1,40 bar-celeste</b> tapón de botella de expansión r.o.</p>	<p><i>¡Nuevo!</i></p>  <p><b>3692</b> tapón de radiador 1.4 hasta '89 (metálico) r.o. 7701018380</p>	<p><i>¡Nuevo!</i></p>  <p><b>3714</b> decantador completo con junta 1.9D r.o.</p>
<p><i>¡Nuevo!</i></p>  <p><b>3717</b> decantador completo con junta 2.0 gasolina, r.o.</p>		

SUSPENSION DELANTERA Y SOPORTES DE MOTOR:

R-19 1.4-1.7-1.8 y 16v

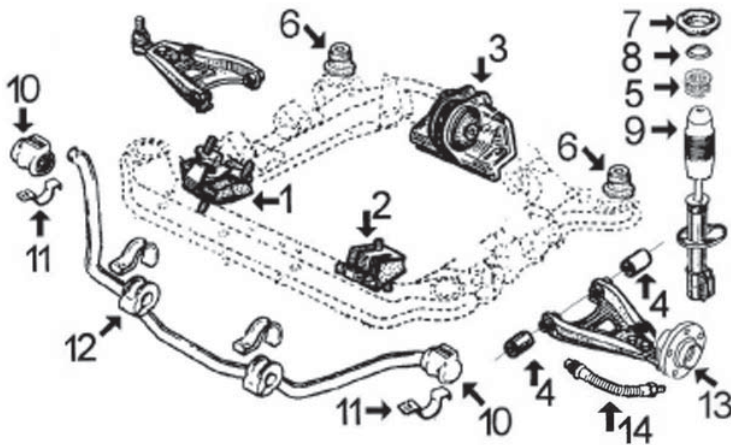

- 1- 705 soporte motor derecho
- 2- 706 soporte motor izquierdo
- 3- 707 soporte motor trasero
- 4- 984 silentbloc trapecio delantero salvo 16v.  
2832 silentbloc trapecio delantero 16v.
- 5- 4329 tope de goma amortiguador delantero
- 6- 4316 silentbloc soporte sub-chasis
- 7- 4151 soporte amortiguador delantero
- 8- 4178 rodamiento soporte amortiguador
- 9- 4173 capuchón amortiguador delantero
- 10- 867 goma puntal para barra estabiliz. de Ø 22 mm  
2483 goma puntal para barra estabiliz. de Ø 23 mm
- 11- 827 abrazadera puntal barra estabilizadora
- 12- 2687 goma central para barra estabiliz. de Ø 22 mm  
868 goma central para barra estabiliz. de Ø 23 mm
- 13- 90020 buje rueda delantera 1.4-1.7-1.8 y 16v  
90015 buje rueda delantera 1.2 (versión no comercializada en España)
- 14- 96075 latiguillo freno delantero (290 mm)

R-19 DIESEL y TURBODIESEL

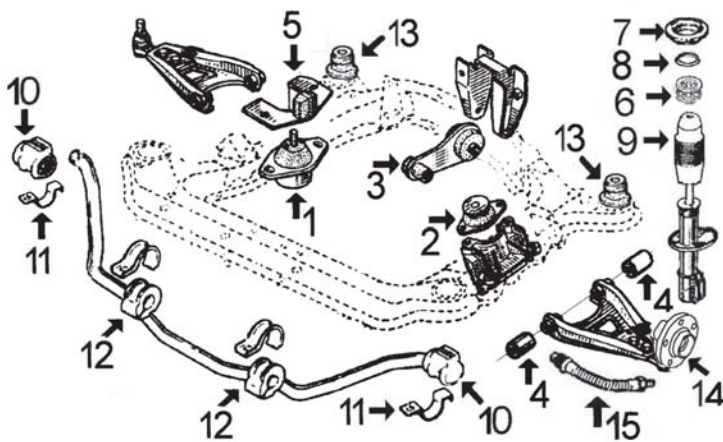





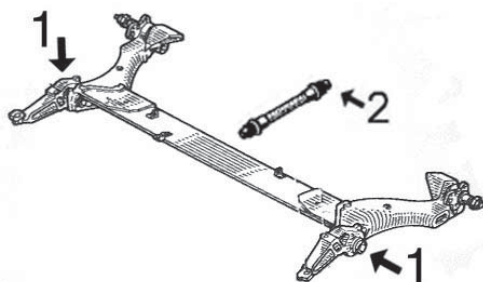









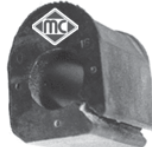



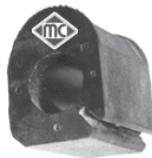

- 1- 963 soporte motor derecho
- 2- 973 soporte motor izquierdo
- 3- 972 soporte motor trasero Diesel  
4026 soporte motor trasero TurboDiesel hasta '95  
972 soporte motor trasero TurboDiesel desde '95
- 4- 984 silentbloc trapecio delantero
- 5- n/d limitador soporte motor derecho
- 6- n/d tope de goma amortiguador delantero
- 7- 4151 soporte amortiguador delantero
- 8- 4178 rodamiento soporte amortiguador
- 9- 4173 capuchón amortiguador delantero
- 10- 867 goma puntal barra estabilizadora
- 11- 827 abrazadera puntal barra estabilizadora
- 12- 2687 goma central para barra estabiliz. de Ø 22 mm  
868 goma central para barra estabiliz. de Ø 23 mm
- 13- 4316 silentbloc soporte sub-chasis
- 14- 90020 buje rueda delantera
- 15- 96075 latiguillo freno delantero (290 mm)

SUSPENSION TRASERA



- 1- 2870 silentbloc interior articulación puente trasero  
2904 silentbloc exterior articulación puente trasero
- 2- 96155 latiguillo freno trasero (285 mm)  
96161 latiguillo freno trasero (270 mm)  
96112 latiguillo freno trasero (190 mm)  
96110 latiguillo freno trasero (245 mm)

## RENAULT 19

 <p><b>705</b> soporte motor derecho 1.4-1.7-1.8 y 16v. r.o. 7700785949</p>	 <p><b>706</b> soporte motor izquierdo 1.4-1.7-1.8 y 16v. r.o. 7700801543</p>	 <p><b>707</b> soporte motor trasero 1.4-1.7-1.8 y 16v. r.o. 7700804163</p>
 <p><b>827</b> abrazadera puntal barra estabilizadora r.o. 7700784169</p>	 <p><b>867</b> goma puntal barra estabiliz. de Ø 22 mm r.o. 7700784170</p>	 <p><b>868</b> goma central barra estabiliz. de Ø 23 mm r.o. 7700785788</p>
 <p><b>963</b> soporte motor derecho Diesel y TurboD r.o. 7700788383 - 7700802927</p>	 <p><b>972</b> soporte motor trasero Diesel r.o. 7700800522</p>	 <p><b>973</b> soporte motor izquierdo Diesel y TurboD r.o. 7700788318</p>
 <p><b>984</b> silentbloc trapecio delantero 1.4-1.7-1.8 y Diesel, r.o. 7700840741 (7700789478)</p>	 <p><b>2483</b> goma puntal barra estabiliz. de de Ø 23 mm r.o. 7700784171</p>	 <p><b>2687</b> goma central para barra estab. de Ø 22 mm r.o. 7700804163</p>
 <p><b>2832</b> silentbloc trapecio delantero 16v. r.o. 7700789477</p>	 <p><b>2870</b> <span style="float: right;">43x76.5x28x28</span> silentbloc interior soporte puente trasero r.o. no hay despiece</p>	 <p><b>2904</b> <span style="float: right;">43x76.5x35x35</span> silentbloc exterior soporte puente trasero r.o. no hay despiece</p>
 <p><b>4026</b> soporte motor trasero TurboDiesel r.o. 7700411638</p>	 <p><b>4151</b> soporte amortiguador delantero r.o. 7700835254 - 7700780875</p>	 <p><b>4173</b> capuchón amortiguador delantero r.o. 7700776743</p>
 <p><b>4178</b> rodamiento soporte amortiguador delantero r.o. 7700797666</p>	 <p><b>4316</b> silentbloc soporte sub-chasis delantero r.o. 7700779772</p>	 <p><b>90015</b> bujes rueda delantera 1.2 (Francia y Portugal), r.o. 7700719140</p>

## RENAULT 19

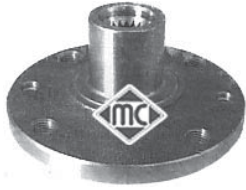

**90020**

buje rueda delantera 1.4-1.7-1.8-16v-D y TD  
r.o. 7700768318-7700768319



**96075**

latiguillo freno delantero (290 mm)  
r.o. 7704003958



**96161**

latiguillo freno trasero (270 mm)  
r.o. 7704003549



**96155**

latiguillo freno trasero (285 mm)  
r.o. 7704003961



**96110**

latiguillo freno trasero (245 mm)  
r.o. 7704001951



**96112**







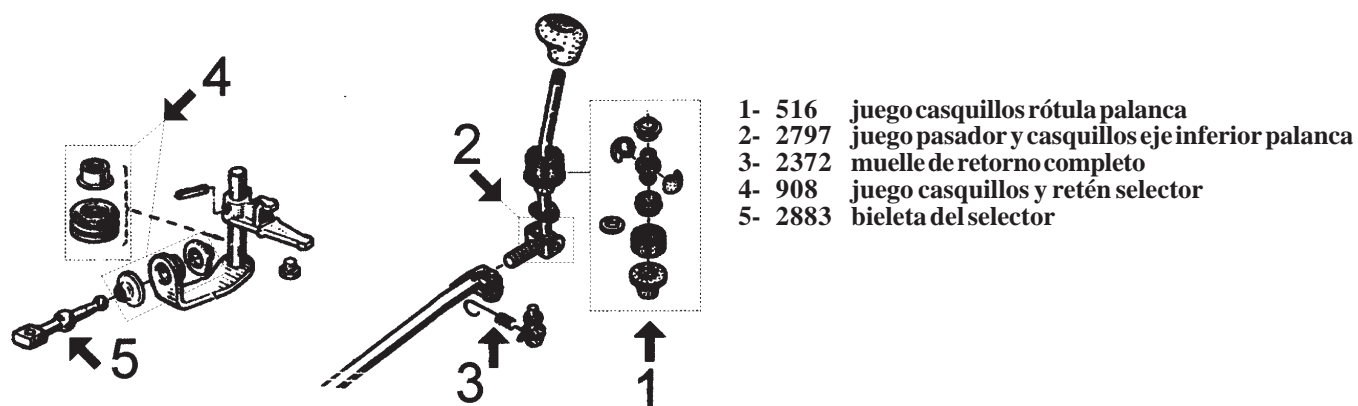





latiguillo freno trasero (190 mm)  
r.o. 7700416273



ARTICULACIONES PALANCA DE CAMBIO:

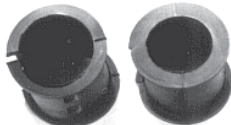

- 1- 516 juego casquillos rótula palanca
- 2- 2797 juego pasador y casquillos eje inferior palanca
- 3- 2372 muelle de retorno completo
- 4- 908 juego casquillos y retén selector
- 5- 2883 bieleta del selector

 <p><b>516</b> juego rótulas palanca de cambio r.o.7700464111</p>	 <p><b>2797</b> juego casquillos y eje pasador palanca de cambio, r.o. no hay despiece</p>	 <p><b>2372</b> juego muelle retorno palanca de cambio r.o.7701468199</p>
 <p><b>908</b> juego casquillos-retén bieleta selector r.o.7703087115+7700679960+7700703000</p>	 <p><b>2883</b> bieleta selector de velocidades completa r.o.7700875584+7700872205+7700743133</p>	 <p><b>498</b> serreta pedal embrague r.o.7700678649</p>
 <p><b>4297</b> horquilla embrague completa r.o.7700725720</p>	 <p><b>1350 kit</b> fuelle cremallera manual r.o.7700678649</p>	 <p><b>350 fuelle</b> <b>444</b> casquillo cremallera manual r.o.7704000926</p>
 <p><b>1561 kit</b> fuelle cremallera asistida r.o.7700706007</p>	 <p><b>561 fuelle</b> <b>2316</b> juego gomas sujeción cremallera asistida r.o.7700778304+7700662571</p>	 <p><b>1517</b> kit reparación transmisión l/rueda r.o.7701035380</p>

## RENAULT 19



**1555**  
kit rep. transmisión dcha. l/rda 1.7/1.8  
y DIESEL, r.o. 7701466122



**1431**  
kit reparación transmisión l/rueda 1.2  
r.o. 7701466120



**1696-E**  
kit reparación transmisión l/rda 1.4 hasta  
'89, **se puede montar con cono**

**¡Nuevo!**



**1128**  
fuente transmisión derecha lado cambio  
bocas de Ø20-80 mm, r.o. 7701469389



**1537** Ø 25.8 mm  
kit reparación transmisión corta l/cambio  
completo con rodamiento, r.o. 7701462100



**1763** Ø 23.8 mm  
kit reparación transmisión corta l/cambio  
completo con rodamiento, 7701464129



**1626**  
kit reparación transm. larga l/cambio 1.4  
hasta '89, r.o. 7701450617



**1523**  
kit reparación transmisión l/cbo 1.4/1.7  
1.8 y DIESEL, r.o. 7701465021



**2849**  
polea cigüeñal Diesel **6 canales**  
r.o. 7700112999(7700724249)

**¡Nuevo!**



**4664**  
polea cigüeñal TurboDiesel  
r.o. 7700856673



**748** Ø 66 mm  
collarín colector y enlace tubos de escape  
r.o.



**749** Ø 69 mm  
collarín colector y enlace tubos de escape  
r.o.



**2381** Ø 67 x 52 mm  
junta cónica colector escape 1.4 y DIESEL  
r.o. 7700797807



**2382** Ø 90 x 73 mm  
junta cónica colector escape 1.7 / 1.8  
r.o. 7700766353



**4154** Ø 72 x 58 mm  
junta cónica colector escape TurboD  
r.o. 7700413217



**753**  
soporte tubo de escape  
r.o. 7700785798



**670**  
tapón cárter aceite 16x150  
r.o. 7903075033

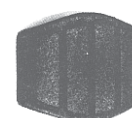

**417**  
cubrepedal freno y embrague  
r.o. 7700680386

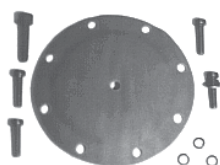

**832**  
juego reparación membrana depresor Diesel  
r.o.

**¡Nuevo!**



**4709**  
soporte filtro de aire  
r.o. 7700744145



**2325**  
tapón de goma Ø 16 mm  
r.o. 7703074094

CANALIZACIONES DE AGUA

R-21 GTS (motor F2N de 1.721 cc -carburador-) hasta '92

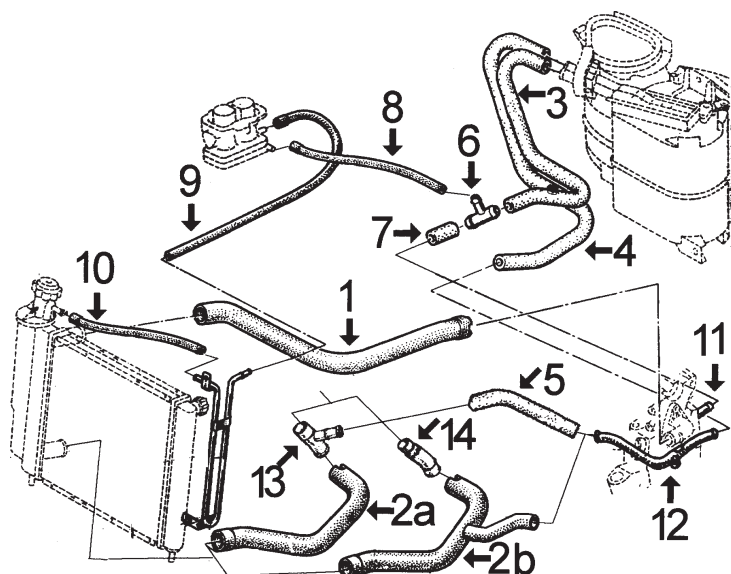

- 1- 7693 mgto superior de radiador hasta '89  
7840 mgto superior de radiador desde '89
- 2a- 7694 mgto inferior de radiador hasta '89 sin aire ac.
- 2b- 8103 mgto inferior de radiador hasta '89 con aire ac.  
7841 mgto inferior de radiador desde '89 hasta '92
- 3- 8107 mgto calefactor a culata hasta '89  
8273 mgto doble de calefactor desde '89
- 4- 7959 mgto calefactor a tubo metálico hasta '89  
8273 mgto doble de calefactor desde '89
- 5- 7957 mgto de boquilla a tubo metálico (sin aire acond. hasta modelo '89)
- 6- 3046 racor 3 vias enlace mgto calefactor-carburador
- 7- 8098 mgto de boquilla en culata a racor 3 vias
- 8- 116 mgto de racor 3 vias a carburador. Cortar de rollo MC-116 Ø 8x14 mm long. 240 mm.
- 9- 116 mgto de carburador a radiador. Cortar de rollo MC-116 Ø 8x14 mm long. 850 mm
- 10- 116 mgto de tubo radiador a tapón. Cortar de rollo MC-116 Ø 8x14 mm long. 500 mm.
- 11- 3033 boquilla clavada en culata
- 12- 3020 tubo de agua metálico
- 13- 3000 boquilla entrada a bloque hasta '89 sin aire ac.
- 14- 3055 boquilla entrada a bloque hasta '89 con aire ac. y desde '89 hasta '92 todas versiones

R-21 GTS desde modelo '92

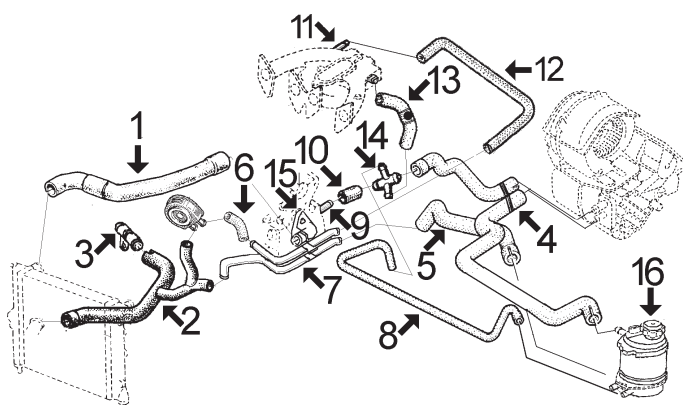

- 1- 7840 mgto superior radiador
- 2- 8434 mgto inferior radiador sin aire acondicionado  
8794 mgto inferior radiador con aire acondicionado
- 3- 3030 boquilla metálica entrada agua a bloque
- 4- 8273 mgto doble de calefactor
- 5- 8454 mgto de tubo metálico a botella expansión
- 6- 8442 mgto de tubo metálico a intercambiador
- 7- 3111 tubo de agua metálico
- 8- 8109 mgto de racor empalme a botella
- 9- 3033 boquilla en culata
- 10- 8098 mgto de racor empalme a culata
- 11- 3010 boquilla en colector de admisión
- 12- 8441 mgto de tubo metálico a colector de admisión
- 13- 8112 mgto de racor empalme a colector
- 14- 3016 racor plástico empalme manguitos
- 15- 3117 tapa de termostato  
2362 junta de termostato
- 16- 3500 botella de expansión  
3524 tapón de botella expansión 1,00 bar (negro)  
3514 tapón de botella de expansión 1,20 bar (verde)  
3525 tapón de botella de expansión 1,40 bar (marrón)

## R-21 TXE (motor J7R de gasolina 1.998 cc -inyección-)

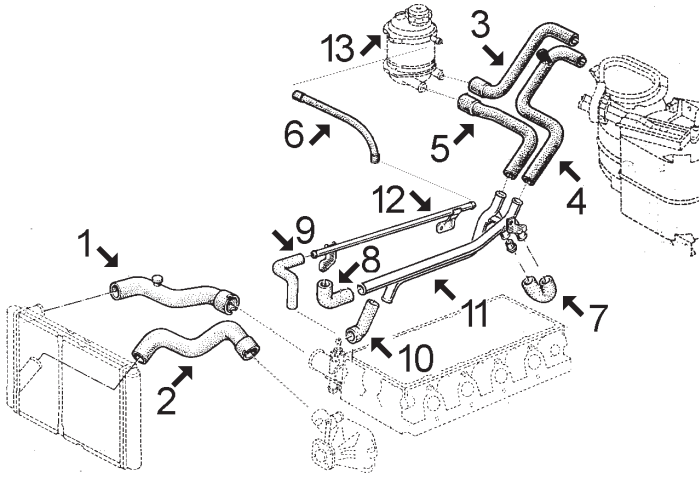

- 1- 7597 mgto superior de radiador TXE
- 8795 mgto superior radiador TXI-12v. (mgto doble: superior + inferior unidos)
- 2- 7598 mgto inferior de radiador TXE hasta '93
- 3- 7961 mgto de botella a calefactor
- 4- 7960 mgto de tubo metálico doble a calefactor
- 5- 7962 mgto de botella a tubo metálico doble
- 6- 116 mgto de botella a tubo metálico superior. Cortar de rollo MC-116 Ø8x14 mm long. 500 mm
- 7- 7966 mgto enlace tubo metálico doble
- 8- 7666 mgto de tubo metálico a termostato
- 9- 7965 mgto de termostato a tubo metálico superior
- 10- 7964 mgto de tubo metálico a bomba de agua
- 11- 3006 tubo de agua metálico
- 12- n/d tubo de agua metálico
- 13- 3500 botella de expansión
- 3514 tapón de botella de expansión 1,20 bar (marrón)
- 3525 tapón de botella de expansión 1,40 bar (celeste)

## R-21 DIESEL (motor J8S de 2.068 cc):

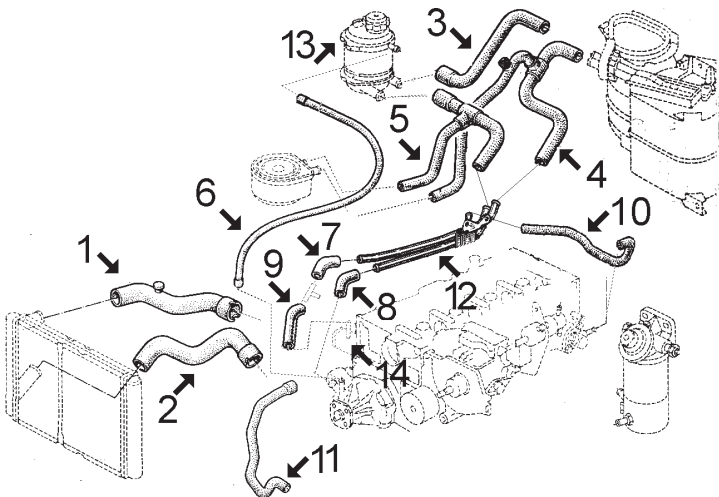

- 1- 7602 mgto superior de radiador
- 2- 7598 mgto inferior de radiador
- 3- 7961 mgto de botella a calefactor
- 4- 8088 mgto de calefactor a tubo metálico e intercambiador hasta '92
- 5- 8089 mgto de botella a tubo metálico e intercambiador hasta '92
- 6- 7967 mgto de botella a termostato
- 7- 8098 mgto de tubo metálico a "T" en termostato
- 8- 7998 mgto de tubo metálico a bomba de agua
- 9- 7968 mgto de tubo metálico a termostato
- 10- 8099 mgto de tubo metálico a boquilla en culata
- 11- 8128 mgto desvaporizador
- 12- n/d tubo de agua metálico
- 13- 3500 botella de expansión
- 3514 tapón de botella de expansión 1,20 bar (marrón)
- 3525 tapón de botella de expansión 1,40 bar (celeste)
- 14- n/d tapa de termostato



## RENAULT 21



**7597**  
mgto superior radiador TXE  
r.o. 7700783013



**7598**  
mgo inferior radiador TXE  
r.o. 7700765108



**7602**  
mgto superior radiador Diesel  
r.o. 7700766112



**7666**  
mgto de tubo a bomba TXE  
r.o. 7700727246



**7693**  
mgto superior radiador GTS hasta '89  
r.o. 7700765783



**7694**  
mgto inferior radiador GTS hasta '89  
r.o. 7700765906



**7840**  
mgto superior radiador GTS desde '90  
con purgador, r.o. 7700787777



**7841**  
mgto inferior radiador GTS desde '89 a '91  
r.o. 7700795418



**7957**  
mgto de tubo a boquilla GTS hasta '89  
r.o. 7700731246



**7959**  
mgto calefactor GTS hasta '89  
r.o. 7700768462



**7960**  
mgto calefactor TXE  
r.o. 7700767138-7700774759



**7961**  
mgto calefactor TXE y Diesel  
r.o. 7700767134



**7962**  
mgto calefactor TXE  
r.o. 7700767136-7700788222



**7964**  
mgto de tubo a bomba de agua TXE  
r.o. 7700851815



**7965**  
mgto de tubo a termostato TXE  
r.o. 7700735749



**7966**  
mgto unión tubo metálico TXE  
r.o. 7705026798



**7967**  
mgto de botella a termostato Diesel  
r.o. 7700773506



**7968**  
mgto de termostato a bomba Diesel  
r.o. 7700733183



**7998**  
mgto de tubo a bomba de agua Diesel  
r.o. 7705026323



**8088**  
mgto de calefactor Diesel hasta '92  
r.o. 7702147988



**8089**  
mgto de tubo a botella Diesel hasta '92  
r.o. 7702147987

## RENAULT 21



**8098**  
mgto de culata a racor 3 vias GTS  
r.o. 7700742500



**8099**  
mgto de tubo metálico a culata Diesel  
r.o. 7700667779



**8103**  
mgto inferior radiador GTS hasta '89 con  
aire ac., r.o. 7700774545



**8107**  
mgto de calefactor GTS hasta '89  
r.o. 7700768460



**8109**  
mgto de sobrante de botella GTS desde '89  
r.o. 7700796053



**8112**  
mgto de racor a colector GTS desde '92  
r.o. 7700851307



**8128**  
mgto desvaporizador Diesel  
r.o. 7700733557



**8273**  
mgto doble de calefactor GTS desde '89  
r.o. 7700805583



**8434**  
mgto inferior radiador GTS desde '92  
r.o. 7700795774



**8441**  
mgto de tubo metálico a colector GTS d/'92  
r.o. 7700748543



**8442**  
mgto de tubo a intercambiador GTS d/'92  
r.o. 7700747061



**8454**  
mgto de tubo a botella GTS desde '92  
r.o. 7700796051



**8794**  
mgto inferior radiador GTS desde '92 con a/a  
r.o.



**8795**  
mgto superior/inferior TXI-12v.  
r.o. 7700806322



**3000**  
boquilla entrada agua a bloque GTS hasta  
'89, r.o. 7700860063



**3030**  
boquilla entrada agua a bloque GTS d/'92  
r.o. 7700860405



**3006**  
tubo de agua metálico TXE  
r.o. 7700857567



**3010**  
boquilla en colector de admisión GTS  
r.o. 7705030338













**3016**  
racor 4 plástico vias empalme mgto GTS  
r.o.



**3020**  
tubo de agua metálico GTS hasta '92  
r.o. 7700731247

## RENAULT 21

 <p><b>3033</b> boquilla en culata GTS r.o. 7705030135</p> <p style="text-align: right;">Ø 20 mm</p>	 <p><b>3046</b> racor metálico empalme mgtos GTS r.o. 7705030028</p>	 <p><b>3117</b> tapa de termostato GTS r.o. 7700851979</p>
 <p><b>3055</b> boquilla entrada agua a bloque GTS con aire acond., r.o. 7700860825</p>	 <p><b>3111</b> tubo de agua metálico GTS desde '92 r.o. 7700860371</p>	 <p><b>2362</b>                      Ø 47 x 55 junta de termostato GTS r.o. 7700718380</p>
 <p><b>3500</b> botella de expansión r.o. 7701203218</p>	 <p><b>3514</b>                      1,20 bar-marrón tapón de botella de expansión r.o.</p>	 <p><b>3525</b>                      1,40 bar-celeste tapón de botella de expansión r.o.</p>
 <p><b>3714</b> decantador completo 2.0 gasolina r.o.</p>		

## SUSPENSION DELANTERA Y SOPORTES DE MOTOR:

R-21 GTS motor F2N gasolina de 1.721 cc:

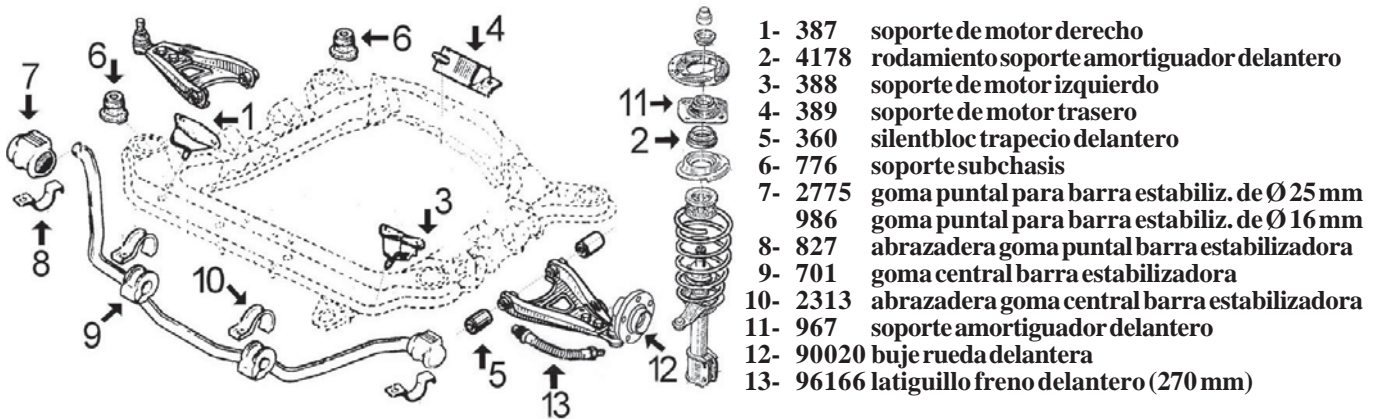





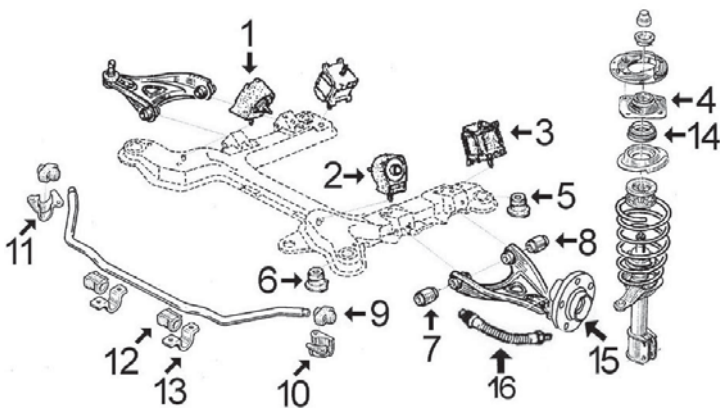

- 1- 387 soporte de motor derecho
- 2- 4178 rodamiento soporte amortiguador delantero
- 3- 388 soporte de motor izquierdo
- 4- 389 soporte de motor trasero
- 5- 360 silentbloc trapecio delantero
- 6- 776 soporte subchasis
- 7- 2775 goma puntal para barra estabiliz. de Ø 25 mm
- 8- 986 goma puntal para barra estabiliz. de Ø 16 mm
- 9- 827 abrazadera goma puntal barra estabilizadora
- 10- 701 goma central barra estabilizadora
- 11- 2313 abrazadera goma central barra estabilizadora
- 12- 967 soporte amortiguador delantero
- 13- 90020 buje rueda delantera
- 13- 96166 latiguillo freno delantero (270 mm)

R-21 TXE y DIESEL, motores J7R de 1.998 cc y J8S de 2.068 cc:

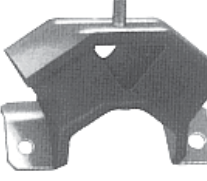
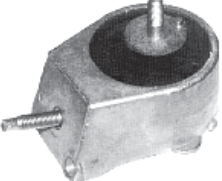
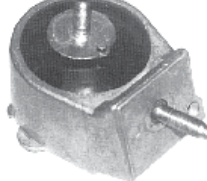
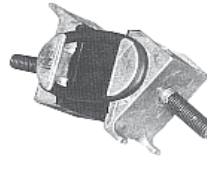

















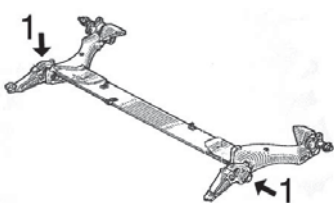

- 1- 702 soporte de motor derecho
- 2- 703 soporte de motor izquierdo
- 3- 769 soporte cambio
- 4- 967 soporte amortiguador delantero hasta '92
- 4- 968 soporte amortiguador delantero desde '92
- 5- 776 soporte trasero subchasis
- 6- 777 soporte delantero subchasis
- 7- 587 silentbloc anterior trapecio delantero
- 8- 588 silentbloc posterior trapecio delantero
- 9- 700 goma puntal barra estabilizadora
- 10- n/d abrazadera izquierda goma puntal barra estab.
- 11- n/d abrazadera derecha goma puntal barra estab.
- 12- 699 goma central barra estabilizadora
- 13- n/d abrazadera goma central barra estabilizadora
- 14- 4178 rodamiento soporte amortiguador delantero
- 15- 90033 buje rueda delantera
- 16- 96076 latiguillo freno delantero (350 mm)

 <p><b>387</b> soporte motor derecho GTS r.o. 7704001318</p>	 <p><b>388</b> soporte motor izquierdo GTS r.o. 7704001320</p>	 <p><b>389</b> soporte motor trasero GTS r.o. 7700765935</p>
 <p><b>702</b> soporte motor derecho TXE-DIESEL r.o. 7700769720</p>	 <p><b>703</b> soporte motor izquierdo TXE-DIESEL r.o. 7700769719</p>	 <p><b>769</b> soporte cambio TXE-DIESEL r.o. 7700766126</p>
 <p><b>360</b> silentbloc trapecio delantero GTS r.o. 7700762574 (12x32x46x36)</p>	 <p><b>587</b> silentbloc anterior trapecio TXE-DIESEL r.o. 7700754515 (12x36x39x51)</p>	 <p><b>588</b> silentbloc posterior trapecio TXE-DIESEL r.o. 7700772687</p>

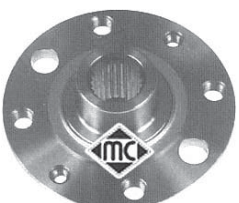
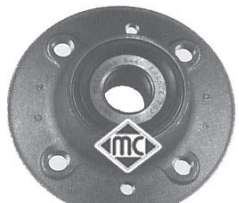

## RENAULT 21

 <p><b>776</b> silentbloc puente trasero GTS-TXE-D r.o. 7700767684</p>	 <p><b>777</b> silentbloc puente delantero TXE-DIESEL r.o. 7700767786</p>	 <p><b>701</b> goma central barra estabilizadora GTS r.o. 7700773245</p>
 <p><b>2775</b> goma puntal para barra estabiliz. de Ø 25 (GTS), r.o. 7700762130</p>	 <p><b>986</b> goma puntal para barra estabiliz. de Ø 16 (GTS), r.o. 7700789412</p>	 <p><b>2313</b> abrazadera goma central barra estab. GTS r.o. 7700757109</p>
 <p><b>827</b> abrazadera goma puntal barra GTS r.o. 7700784169</p>	 <p><b>699</b> goma central barra estab. TXE-DIESEL r.o. 7700774026</p>	 <p><b>700</b> goma puntal barra estab. TXE-DIESEL r.o. 7700771562</p>
 <p><b>4178</b> rodamiento soporte amortiguador delantero r.o. 7700803635</p>	 <p><b>967</b> soporte amortiguador delantero GTS todos y TXE-DIESEL hasta '91, r.o. 7700757691</p>	 <p><b>968</b> soporte amortiguador delantero TXE y D desde '91, r.o. 7700795187</p>
 <p><b>4262</b> silentbloc articulación puente trasero (nº 1 en gráfico adjunto), r.o.</p>		 <p><b>90020</b> buje de rueda delantera 1.7 GTS r.o. 7700768319</p>
 <p><b>90033</b> buje de rueda delantera 2.0 TXE y Diesel r.o. 7700715149</p>	 <p><b>90527</b> buje de rueda trasera con rodamiento r.o. 7701204692</p>	 <p><b>96076</b> latiguillo freno delantero TXE-D (350 mm) r.o. 7704003955</p>
 <p><b>96166</b> latiguillo freno delantero GTS (270 mm) r.o. 7704003887</p>	 <p><b>96065</b> latiguillo freno trasero sin ABS (305 mm) r.o. 7704003905</p>	 <p><b>96078</b> latiguillo freno trasero con ABS (30 mm) r.o. 7700832611</p>

ARTICULACIONES PALANCA DE CAMBIO:

GTS:

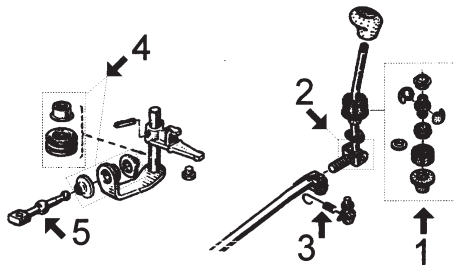

TXE y DIESEL:

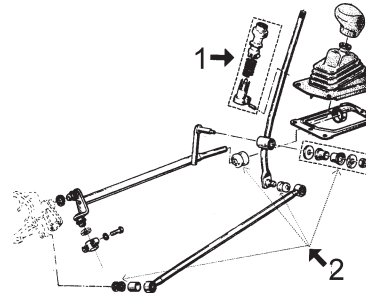

- 1- 516 juego de casquillos palanca de cambio
- 2- 2797 juego casquillos y eje pasador
- 3- 2372 juego completo muelle de retorno
- 4- 908 juego casquillos bieleta selector
- 5- 2883 bieleta selector

- 1- n/d juego casquillos palanca de cambio
- 2- 907 juego casquillos barras mando cambio



**516**  
juego casquillos palanca cambio GTS  
r.o. 7700464111



**908**  
juego casquillos bieleta selector GTS  
r.o. 7703087115+7700679960



**2372**  
juego completo muelle de retorno GTS  
r.o. 7701468199

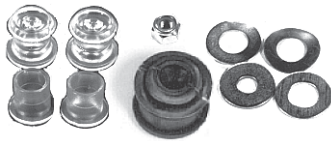

**907**  
juego casquillos levas cambio TXE-DIESEL  
r.o. 7700689713+7700692252

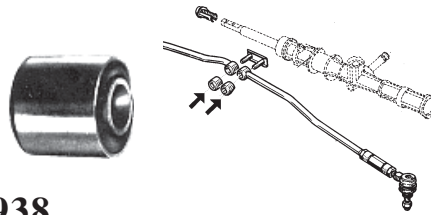

**938**  
silentbloc barras dirección TXE-DIESEL  
r.o. no hay despiece (10x23x19x24.5)



**2850**  
polea cigueñal 2.1 Diesel  
r.o. 7700853470



**2797**  
juego casquillos y eje pasador palanca de cambio GTS, r.o. no hay despiece



**2883**  
bieleta selector velocidades completa GTS  
r.o. 7700875584+7700872205+7700743133



**4297**  
horquilla embrague completa R-21 GTS  
r.o. 7700725720+7700715851



**895**  
serreta pedal embrague TXE-DIESEL  
r.o.

**¡Nuevo!**



**4709**  
soporte filtro de aire (largo)  
r.o. 7700744145



**153**  
soporte filtro de aire (corto)  
r.o. 7704002509

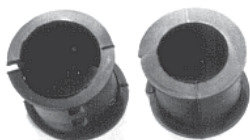

**2316**  
juego gomas sujeción cremallera GTS  
r.o. 7700778304+7700662571

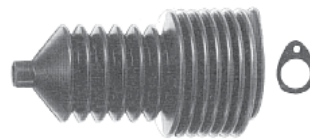

**1561**  
fuelle cremallera dirección GTS  
r.o. 7700706007



**1274E** (GTS)  
kit rep. tr. l/rda para montar en cono  
(en neopreno especial elasticidad 800%)

## RENAULT 21

 <p><b>1557E</b> (GTS) kit. rep. tr. l/rda. <b>para montar con cono</b> (en neopreno especial de elasticidad 800%)</p>		
 <p><b>1555</b> kit rep. transmisión l/rda GTS desde '92 r.o. 7701466122</p>	 <p><b>1575E</b> <b>para montar con cono</b> kit rep. transmisión l/rda TXE-DIESEL (transm. GKN), r.o. 7701202583</p>	 <p><b>1575</b> kit rep. transmisión l/rda TXE-DIESEL (transm. GKN), r.o. 7701202583</p>
 <p><b>1732</b> kit rep. transmisión l/rueda TXE-DIESEL (transmisión Löbro), r.o. 7701033432</p>	 <p><b>1732E</b> kit rep. transmisión l/rueda TXE-DIESEL (transm. Löbro) <b>Se puede montar con cono</b></p>	 <p><b>1517</b> kit rep. transm. l/rda TXE-DIESEL d/'92 r.o. 7701035380</p>
 <p><b>1432</b> kit rep. tr. l/rda TXE-DIESEL desde '92 r.o. 7701034800</p>	 <p><b>1367</b> kit rep. transmisión derecha l/cambio GTS r.o. 7701462101</p>	 <p><b>1537</b> <b>Ø25.8 mm</b> kit rep. transmisión corta l/cambio GTS completo c/rodamiento r.o. 7700462100</p>
 <p><b>1523</b> kit rep. transm. l/cambio TXE-DIESEL r.o. 7701465021</p>	 <p><b>748</b> collarín empalme tubo de escape r.o. 7701458496</p>	 <p><b>240</b> soporte colector escape r.o.</p>
 <p><b>280</b> soporte trasero tubo escape r.o. 7700686449</p>	 <p><b>281</b> soporte intermedio tubo de escape r.o. 7700677773</p>	 <p><b>670</b> tapón cárter aceite r.o. 7903075033</p>
 <p><b>832</b> jgo reparación membrana depresor Diesel r.o.</p>		

# RENAULT R-25

## SUSPENSION DELANTERA y SOPORTES DE MOTOR:

R-25 desde '88 a '93

2.0 gasolina motor J7R  
2.1 diesel motor J8S

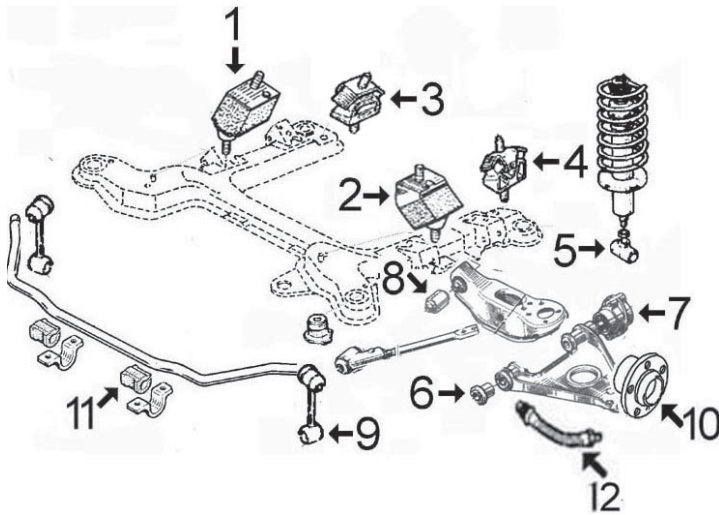

- 1- 4119 soporte motor derecho
- 2- 4120 soporte motor izquierdo
- 3- 4971 soporte derecho cambio
- 4- 4972 soporte izquierdo cambio
- 5- 211 silentbloc soporte amortiguador delantero
- 6- 4199 silentbloc anterior trapecio delantero
- 7- 4217 silentbloc posterior trapecio delantero
- 8- 4580 silentbloc brazo superior delantero
- 9- 4574 bieleta puntal barra estabilizadora
- 10- 90033 buje rueda delantera
- 11- 4573 goma barra estabilizadora
- 12- 96079 latiguillo freno delantero

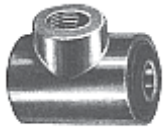

**211**  
silentbloc inferior amortiguador delantero hasta '93, r.o. 7701348300



**4119**  
soporte motor derecho desde '88 r.o. 7700783016



**4120**  
soporte motor izquierdo desde '88 r.o. 7700783018



**4199**  
silentbloc anterior trapecio delantero r.o. 7700781463



**4217**  
silentbloc posterior trapecio delantero r.o. 7700781441

**¡Nuevo!**



**4573**  
goma barra estabilizadora r.o. 7700797821

**¡Nuevo!**



**4574**  
bieleta puntal barra estabilizadora r.o. 7700781500

**¡Nuevo!**



**4580** (10x38x43x58)  
silentbloc brazo superior delantero r.o. 7704001734



**¡Nuevo!**



**4971**  
soporte **derecho** cambio r.o. 7700783017

**¡Nuevo!**

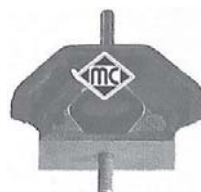

**4972**  
soporte **izquierdo** cambio r.o. 7700783019

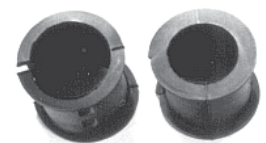

**2316**  
jgo. gomas sujeción cremallera asistida r.o. 7700778304+7700662571



## RENAULT R-25

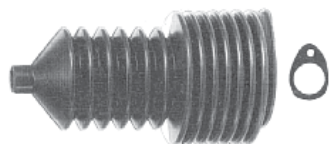

**1561**  
fuelle cremallera dirección asistida  
r.o. 7700706007



**1693**  
kit rep. transmisión lado rueda  
r.o. 7701202743



**1523**  
kit rep. transmisión l/cambio  
r.o. 7701466349

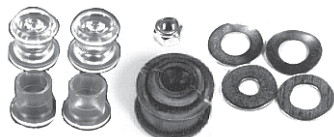

**907**  
juego casquillos levas cambio  
r.o. 7700689713+7700692252



**908**  
juego casquillos retén palanca selector  
r.o. 7700679960-7703087163



**2883**  
bioleta selector de velocidades completa  
r.o. 7700875584+7700872205



**90033**  
bujes de rueda delantera  
r.o. 7700715149



**90527**  
bujes de rueda trasera con rodamiento  
r.o. 7701204692-7701204667



**2850**  
polea cigüeñal motor 2.1 Diesel  
r.o. 7700853470

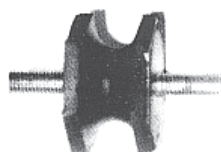

**240**  
soporte tubo de escape  
r.o. 7700565762



**262**  
soporte posterior tubo de escape  
r.o.



**670**  
tapón cárter de aceite todos modelos  
r.o. 7903075033



**153**  
soporte filtro de aire  
r.o. 7704002509



**96079**  
latiguillo freno delantero (430 mm)  
r.o. 7701204831



**3692**  
tapón de radiador (metálico)  
r.o. 7701018380

## CANALIZACIONES DE AGUA:

### CLIO-I 1.1 (motor C1E):

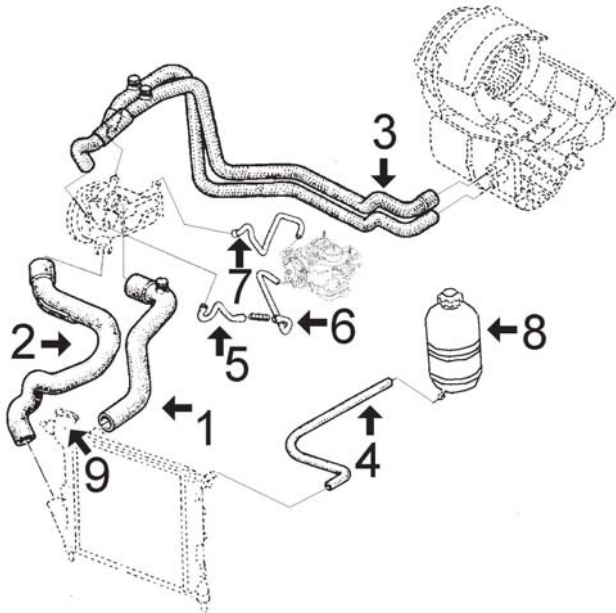

- 1- 7842 mgto superior de radiador
- 2- 7843 mgto inferior de radiador
- 3- 8424 mgto doble de calefactor a bomba de agua
- 4- 760 mgto sobrante de botella. Cortar de rollo MC-760 Ø 6x10 mm
- 5- 7969 mgto de bomba a carburador, 1er. tramo
- 6- 7970 mgto de bomba a carburador, 2º tramo
- 7- 7671 mgto de carburador a bomba
- 8- 3501 botella de expansión  
3519 tapón de botella expansión 0,70 bar  
3524 tapón de botella expansión 1,00 bar  
3514 tapón de botella expansión 1,20 bar
- 9- 3692 tapón de radiador (metálico)



- 7669 mgto desvaporizador
- 7670 mgto desvaporizador

### CLIO-I 1.2 (hasta '96, motor E7F) y 1.4 (motor E7J):

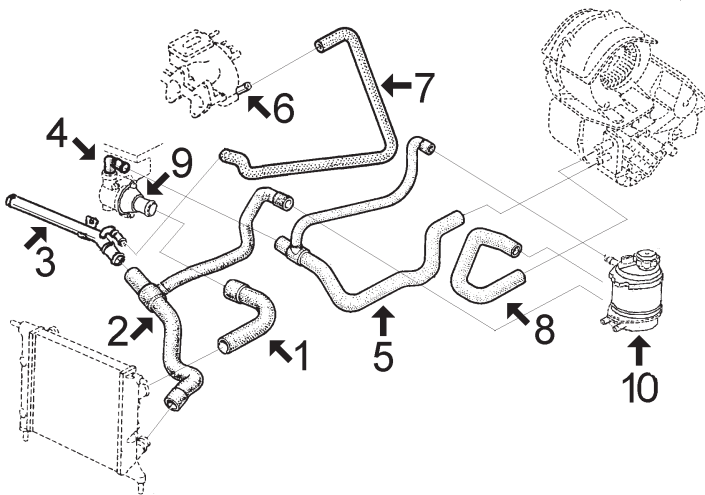

- 1- 7844 mgto superior radiador sin aire acondicionado  
7955 mgto superior radiador con aire acondicionado
- 2- 7845 mgto inferior radiador sin aire acondicionado  
7956 mgto inferior radiador con aire acondicionado
- 3- 3028 tubo metálico con junta tórica
- 4- 3173 caja de termostato
- 5- 8134 mgto de tapa termostato a calefactor
- 6- 3010 boquilla en colector de admisión
- 7- 7907 mgto de tubo metálico a colector de admisión
- 8- 8135 mgto de calefactor a botella
- 9- 3116 tapa de termostato (aluminio)  
2404 junta de termostato
- 10- 3500 botella de expansión  
3519 tapón de botella expansión 0,70 bar  
3524 tapón de botella expansión 1,00 bar  
3514 tapón de botella expansión 1,20 bar



- 8818 jgo mgto desvaporizadores

## CLIO-I 1.2 desde 12/'96 (motor D7F)

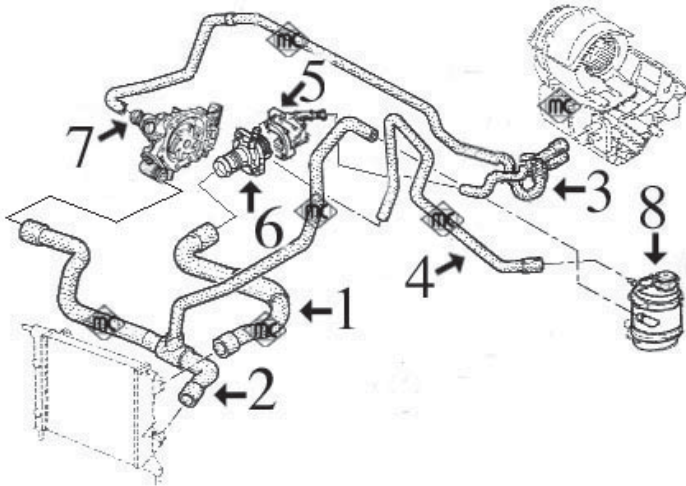

- 1- 8711 mgto superior radiador
- 2- 8709 mgto inferior radiador sin aire acondicionado  
8710 mgto inferior radiador con aire acondicionado
- 3- 8706 mgto doble de calefactor a bomba y cuerpo termost.
- 4- 8712 mgto de botella a tapa termostato
- 5- 3147 cuerpo de termostato
- 6- 3156 tapa con termostato
- 7- 3148 boquilla metálica en tapa bomba de agua
- 8- 3500 botella de expansión  
3519 tapón de botella expansión 0,70 bar  
3524 tapón de botella expansión 1,00 bar  
3514 tapón de botella expansión 1,20 bar

## CLIO-I 16v (motor F7P):

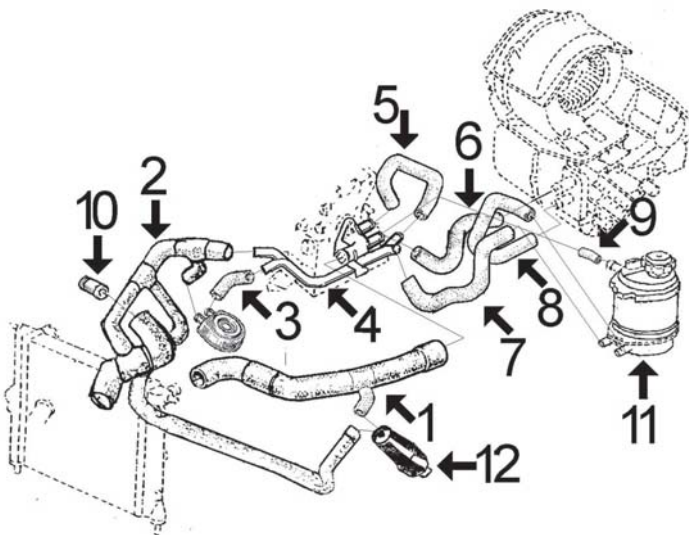

- 1- 8142 mgto superior radiador
- 2- 8429 mgto inferior radiador (con válvula antiretorno)
- 3- 8040 mgto de tubo metálico a intercambiador
- 4- n/d tubo de agua metálico
- 5- n/d mgto de tubo a caja termostato
- 6- n/d mgto de tubo metálico a calefactor
- 7- n/d mgto de tubo metálico a botella
- 8- 8135 mgto de calefactor a botella
- 9- n/d mgto de sobrante de botella a termostato
- 10- 3004 boquilla metálica entrada agua a bloque
- 11- 3500 botella de expansión  
3525 tapón de botella de expansión 1,40 bar (marrón)
- 12- n/d bomba de recirculación

CLIO-I 1.7 (motor F2N) y 1.8 (motor F3P) hasta 12/'96:

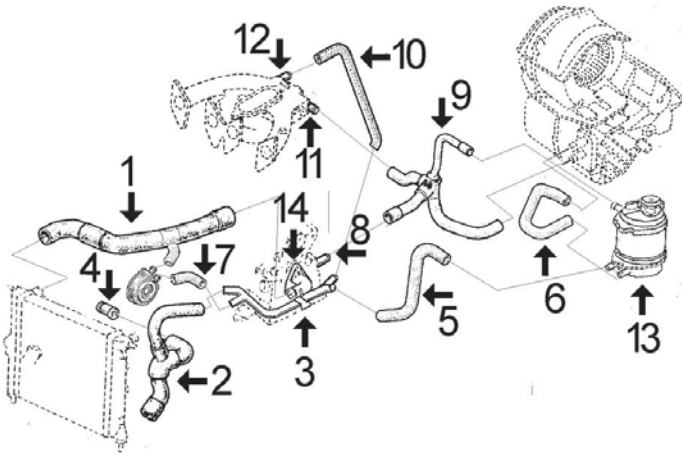

- 1- 8129 mgto superior radiador sin aire acondicionado  
8122 mgto superior radiador con aire acondicionado (3 vias, 3ª via va a intercambiador)
- 2- 8124 mgto inferior radiador sin aire acondicionado  
8123 mgto inferior radiador con aire acondicionado
- 3- 3065 tubo de agua metálico 1.7 todos y 1.8 sin aire ac.  
3106 tubo de agua metálico 1.8 con aire acondicionado
- 4- 3055 boquilla entrada agua a bloque 1.7 todos y 1.8 sin aire acondicionado  
3107 boquilla entrada agua a bloque 1.8 con aire ac.
- 5- 8168 mgto de tubo metálico a botella
- 6- 8135 mgto de calefactor a botella
- 7- 8040 mgto de tubo rígido a intercambiador (sólo versiones con aire acondicionado)
- 8- 3033 boquilla en culata
- 9- 8274 mgto multisalidas de calefactor-tubo-botella 1.7  
8430 mgto multisalidas de calefactor-tubo-botella 1.8
- 10- 8427 mgto de tubo metálico a colector 1.7  
n/d mgto de tubo metálico a colector 1.8
- 11- 3010 boquilla en colector de admisión
- 12- 3050 boquilla en colector de admisión
- 13- 3500 botella de expansión  
3524 tapón de botella expansión 1,00 bar  
3514 tapón de botella de expansión 1,20 bar  
3525 tapón de botella de expansión 1,40 bar
- 14- 3117 tapa de termostato (aluminio)  
2362 junta de termostato

CLIO-I 1.8 (motor F3P) desde 12/'96:

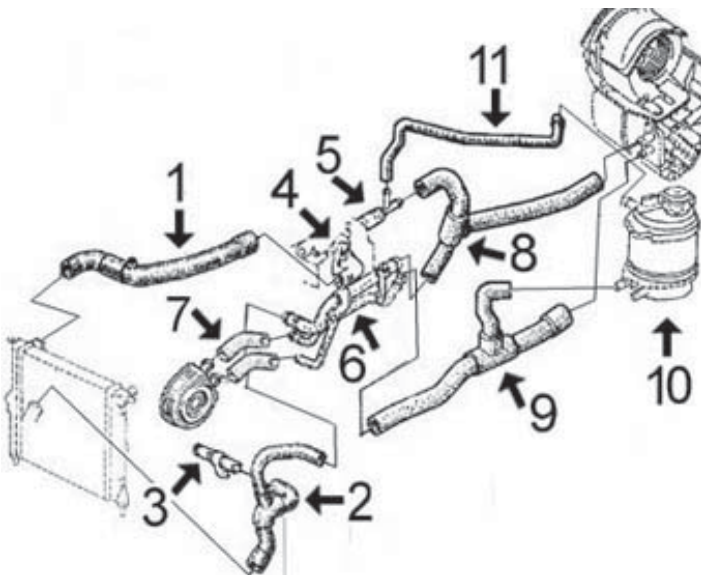

- 1- 8129 mgto superior radiador sin aire acondicionado  
8122 mgto superior radiador con aire acondicionado (3 vias, 3ª via va a intercambiador)
- 2- 8124 mgto inferior radiador sin aire acondicionado  
8925 mgto inferior radiador con aire acondicionado
- 3- 3107 boquilla entrada agua a bloque
- 4- 3117 tapa de termostato
- 5- 3029 boquilla 3 vias en culata
- 6- 3172 tubo de agua metálico
- 7- 8040 mgto de tubo rígido a intercambiador (sólo versiones con aire acondicionado)
- 8- 8926 mgto de tubo y boquilla en culata a calefactor
- 9- 8924 mgto de tubo metálico a calefactor
- 10- 3500 botella de expansión  
3514 tapón de botella de expansión 1,20 bar  
3525 tapón de botella de expansión 1,40 bar
- 11- n/d mgto de boquilla en culata a calefactor



## RENAULT CLIO - I (hasta '98)

### CLIO-I 1.9 DIESEL con intercambiador de calor en el filtro de gasoil e intercambiador en el filtro de aceite:

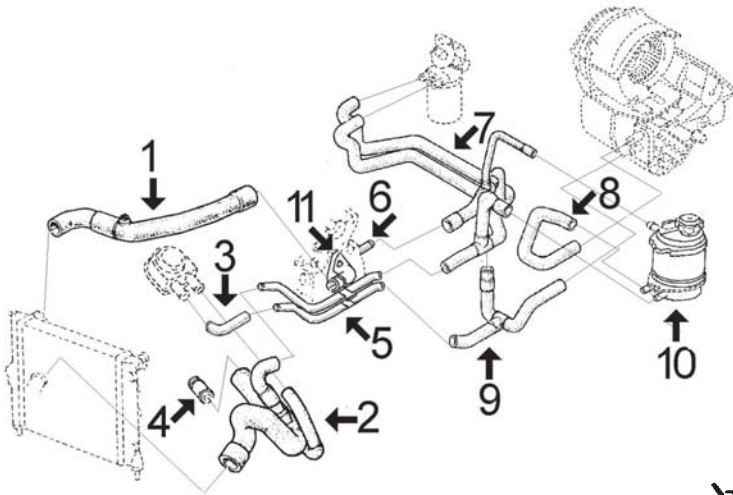

- 1- 7846 mgto superior radiador (con purgador)
- 2- 7847 mgto inferior radiador (4 vias)
- 3- 8170 mgto de tubo rígido a intercambiador
- 4- 3055 boquilla metálica entrada agua a bloque
- 5- 3058 tubo de agua metálico
- 6- 3033 boquilla metálica en culata
- 7- 8425 mgto doble de tubo a botella, intercambiador en filtro de gasoil y calefactor
- 8- 8135 mgto de calefactor a botella
- 9- 8426 mgto de calefactor a tubo y a mgto 3 vias
- 10- 3500 botella de expansión
- 3524 tapón de botella de expansión 1,00 bar
- 3514 tapón de botella de expansión 1,20 bar
- 3525 tapón de botella de expansión 1,40 bar
- 11- 3117 tapa de termostato (aluminio)
- 2362 junta de termostato



- 8665 mgto desvaporizador
- 8666 mgto desvaporizador
- 8751 mgto desvaporizador

### CLIO-I 1.9 DIESEL sin intercambiador de calor en el filtro de gasoil pero con intercambiador en el filtro de aceite:

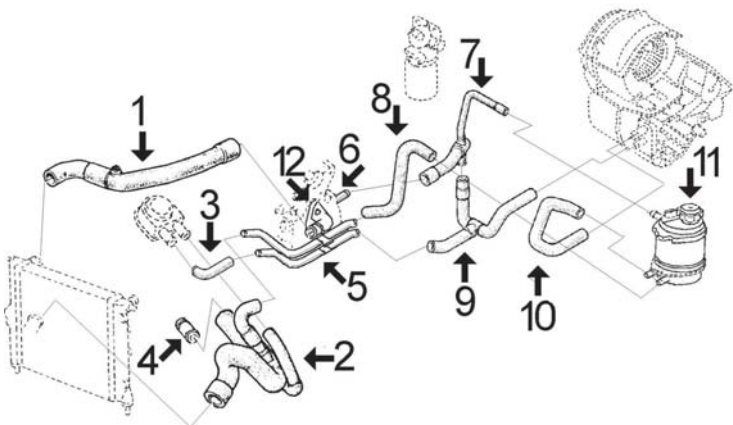

- 1- 7846 mgto superior radiador (con purgador)
- 2- 7847 mgto inferior radiador (4 vias)
- 3- 8170 mgto de tubo rígido a intercambiador
- 4- 3055 boquilla metálica entrada agua a bloque
- 5- 3058 tubo de agua metálico
- 6- 3033 boquilla metálica en culata
- 7- 8431 mgto de empalme mgto a tubo y botella
- 8- 8458 mgto de tubo metálico a botella
- 9- 8426 mgto de calefactor a tubo y a mgto 3 vias
- 10- 8135 mgto de calefactor a botella de expansión
- 11- 3500 botella de expansión
- 3524 tapón de botella de expansión 1,00 bar
- 3514 tapón de botella de expansión 1,20 bar
- 3525 tapón de botella de expansión 1,40 bar
- 12- 3117 tapa de termostato (aluminio)
- 2362 junta de termostato



- 8665 mgto desvaporizador
- 8666 mgto desvaporizador
- 8751 mgto desvaporizador

## CLIO-I 1.9 DIESEL sin intercambiador de calor en el filtro de gasoil ni intercambiador en el filtro de aceite:

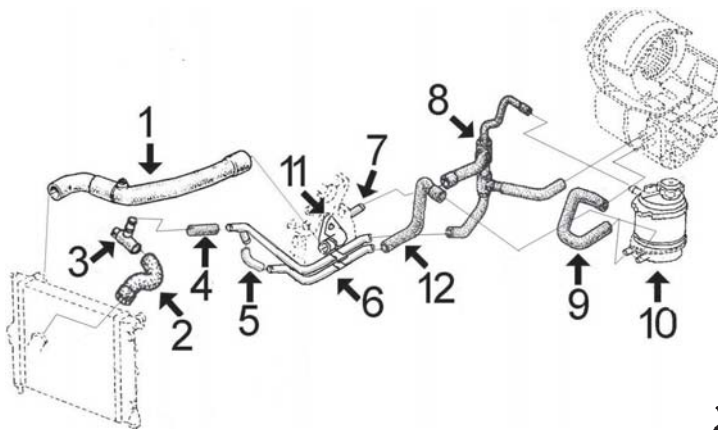

- 1- 7846 mgto superior radiador (con purgador)
- 2- 8076 mgto inferior radiador hasta 12/'97
- 8928 mgto inferior radiador desde 12/'97
- 3- 3665 boquilla entrada agua a bloque
- 4- 8098 mgto de tubo metálico a boquilla
- 5- 119 mgto empalme en tubo metálico, cortar de rollo MC-119 Ø 16x22 mm long. 230 mm
- 6- 3125 tubo de agua metálico
- 7- 3033 boquilla en culata
- 8- 8927 mgto de culata y tubo metálico a calefactor
- 9- 8135 mgto de botella a calefactor
- 10- 3500 botella de expansión
- 3514 tapón de botella de expansión 1,20 bar
- 3525 tapón de botella de expansión 1,40 bar
- 12- 8458 mgto de tubo metálico a botella



- ~~8665 mgto desvaporizador~~
- ~~8666 mgto desvaporizador~~
- ~~8751 mgto desvaporizador~~

## MANGUITOS DESVAPORIZADORES motor F8Q 1.9D hasta '96:

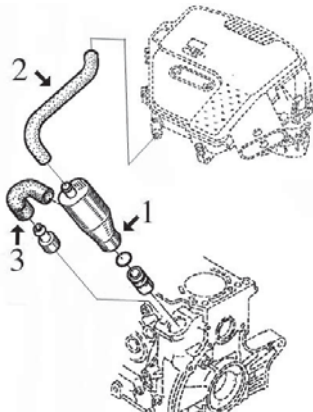

- 1- 3714 decantador completo con junta tórica
- 2- 8751 mgto de decantador a caja filtro
- 3- 8666 mgto de decantador a bloque motor

## MANGUITOS DESVAPORIZADORES motor F8Q 1.9D desde '96:

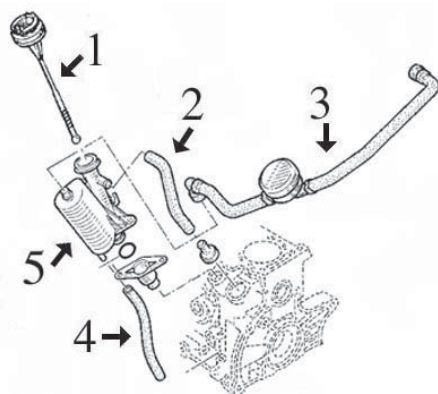

- 1- n/d varilla nivel aceite
- 2- 8752 mgto superior de caja reguladora a bloque
- 3- 9095 mgto de caja reguladora a culata con válvula
- 4- 8753 mgto inferior de caja reguladora a bloque
- 5- 3717 decantador completo con junta tórica

## RENAULT CLIO - I (hasta '98)



**7669**

mgto desvaporizador 1.1  
r.o. 7700678777



**7670**

mgto desvaporizador 1.1  
r.o. 7700678778



**7671**

mgto de bomba a carburador 1.1  
r.o. 7700726561



**7842**

mgto superior radiador 1.1  
r.o. 7700801058



**7843**

mgto inferior radiador 1.1  
r.o. 7700816995



**7844**

mgto superior radiador 1.2-1.4 sin aire ac.  
r.o. 7700801054



**7845**

mgto inferior radiador 1.2-1.4 sin aire ac.  
r.o. 7700801055



**7846**

mgto superior radiador Diesel  
r.o. 7700824034



**7847**

mgto inferior radiador Diesel  
r.o. 7700801067



**7907**

mgto de tubo a colector admisión 1.2-1.4  
r.o. 7700741327



**7955**

mgto superior radiador 1.2-1.4 con aire ac.  
r.o. 7700801061



**7956**

mgto inferior radiador 1.2-1.4 con aire ac.  
r.o. 7700804633



**7969**

mgto de bomba a carburador 1.1  
r.o. 7700739814



**7970**

mgto de bomba a carburador 1.1  
r.o. 7700739813



**8040**

mgto de tubo a intercambiador 1.7-1.8 y  
16v, r.o. 7700853277



**8076**

mgto inferior radiador Diesel desde '95  
r.o. 60060001231



**8122**

mgto superior radiador 1.7-1.8 con aire ac.  
r.o. 7700816994 (7700810674)



**8123**

mgto inf radiador 1.7-1.8 con aire acond.  
r.o. 7700815385



**8124**

mgto inferior radiador 1.7-1.8 sin aire ac.  
r.o. 7700813856



**8129**

mgto superior radiador 1.7-1.8 sin aire ac.  
r.o. 7700801062



**8134**

mgto de calefact. a caja de termostato 1.2-1.4, r.o. 7700801056 (7700271598)

## RENAULT CLIO - I (hasta '98)



**8135**

mgto de calefact. a botella 1.7-1.8-16v y D  
r.o. 7700813971



**8142**

mgto superior radiador 16v  
r.o. 770083837



**8168**

mgto de tubo metálico a botella 1.7-1.8  
r.o. 7700801065



**8170**

mgto de tubo a intercambiador Diesel  
r.o. 7700749885



**8274**

mgto de calefactor a tubo-colector 1.7  
r.o. 7700801066+7700801064



**8424**

mgto doble de calefactor a bomba 1.1  
r.o. 7700801060-7700818384

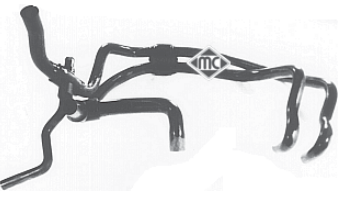

**8425**

mgto doble de calefactor-filtro gasoil D  
r.o. 7700412082



**8426**

mgto de calefactor a tubo Diesel  
r.o. 7700801072



**8427**

mgto de tubo metálico a colector 1.7  
r.o. 7700749531



**8429**

mgto inferior radiador 16v  
r.o. 7700804634



**8430**

mgto calefactor a tubo 1.8  
r.o. 7700814668+7700801064



**8431**

mgto de tubo a empalme Diesel  
r.o. 7700843760



**8458**

mgto de botella a tubo Diesel  
r.o. 7700843761



**8665**

mgto desvaporizador 1.9 Diesel  
r.o.



**8666**

mgto desvaporizador 1.9 Diesel  
r.o.



**8706**

mgto doble de calefactor 1.2 desde '96  
r.o.



**8709**

mgto inferior radiador 1.2 (D7F) sin aire  
acondicionado, r.o.



**8710**

mgto inferior radiador 1.2 (D7F) con aire  
acondicionado, r.o.



**8711**

mgto superior radiador 1.2 desde '96  
r.o.























**8712**

mgto de botella a termostato 1.2 desde '96  
r.o.



## RENAULT CLIO - I (hasta '98)

  <p><b>8751</b> mgto desvaporizador 1.9 Diesel r.o.</p>	  <p><b>8752</b> mgto desvaporizador 1.9 Diesel r.o.</p>	  <p><b>8753</b> mgto desvaporizador 1.9 Diesel r.o.</p>
  <p><b>8818</b> jgo mgto desvaporizadores 1.4 r.o.</p>	  <p><b>8924</b> mgto de tubo a calefactor 1.8 desde '96 r.o.</p>	
  <p><b>8925</b> mgto inferior radiador 1.8 desde '96 con a/a r.o.</p>	  <p><b>8926</b> mgto de tubo y culata a calefactor 1.8 desde '96, r.o.</p>	  <p><b>8927</b> mgto de tubo y culata a calefactor 1.9D r.o.</p>
  <p><b>8928</b> mgto inferior radiador 1.9 Diesel r.o.</p>	   <p><b>9095</b> mgto desvaporizador 1.9D con válvula r.o. 8200136128</p>	

## RENAULT CLIO - I (hasta '98)



**3004**  
boquilla entrada agua a bloque 16v  
r.o. 7700860014



**3010**  
boquilla en colector de admisión 1.2-1.4  
1.7 y 1.8, r.o. 7705030338



**3028** con junta tórica  
tubo de agua metálico 1.2-1.4  
r.o. 7700859465



**3029**  
boquilla en culata 1.8 desde '96  
r.o.



**3033** Ø 20 mm  
boquilla en culata 1.7-1.8 y D  
r.o. 7705030135



**3055**  
boquilla entrada agua a bloque 1.7-1.8 y D  
r.o. 7700860825



**3058**  
tubo de agua metálico Diesel hasta '95  
r.o. 7700864993



**3065**  
tubo de agua metálico 1.7 todos y 1.8 sin  
aire ac., r.o. 7700860386 (7700853208)



**3106**  
tubo de agua metálico 1.8 con aire acond.  
r.o. 7700858911



**3107** con junta tórica  
boquilla entrada agua a bloque 1.8 con aire  
acondicionado, r.o. 7700859544



**3125**  
tubo de agua metálico Diesel desde '95  
r.o. 7700873509



**3116**  
tapa de termostato 1.2-1.4  
r.o. 7700738110



**3117**  
tapa de termostato 1.7-1.8 y Diesel  
r.o. 7700851979



**3147**  
cuerpo de termostato 1.2 desde '96  
r.o. 7700864962



**3148** Ø 18 mm  
boquilla en tapa bomba de agua 1.2 desde '96  
r.o. no hya despiece



**3156**  
tapa con termostato 1.2 desde '96  
r.o. 7700868980



**3172**  
tubo de agua metálico 1.8 desde '96  
r.o. 7700866559



**3173**  
caja de termostato 1.2(hasta '96)- 1.4  
r.o. 7700272358



**3665**  
boquilla entrada agua a bloque 1.9D  
r.o. 7700101034



**3714**  
decantador completo 1.9 D hasta 3/'96  
r.o.

## RENAULT CLIO - I (hasta '98)

**¡nuevo!**



**3717**

decantador completo 1.9 D desde 3/'96  
r.o.



**3500**

botella de expansión 1.2-1.4-1.7-1.8-16v-D  
r.o. 7701203218-7700810997



**3501**

botella de expansión 1.1  
r.o. 7701203249



**3519**

**0,70 bar-blanco**

tapón de botella de expansión  
r.o.



**3524**

**1,00 bar-verde**

tapón de botella de expansión  
r.o.



**3514**

**1,20 bar-marron**

tapón de botella de expansión  
r.o.



**3525**

**1,40 bar-celeste**

tapón de botella de expansión  
r.o.



**2404**

**Ø 44 x 52**

junta de termostato 1.2 hasta '96 y 1.4  
r.o. 7700741923



**2362**

**Ø 47 x 55**

junta de termostato 1.7-1.8-D  
r.o. 7700718380

**¡nuevo!**



**3692**

tapón de radiador 1.1 (metálico)  
r.o. 7701018380

## SUSPENSION DELANTERA y SOPORTES DE MOTOR

### CLIO-I 1.1

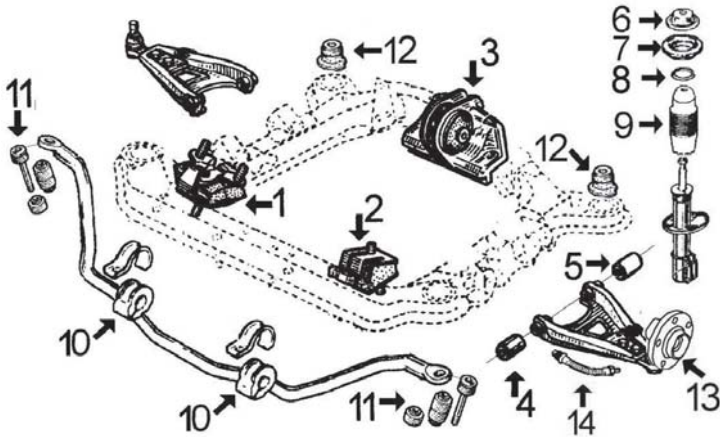

- 1- 2953 soporte motor derecho
- 2- 4155 soporte motor izquierdo
- 3- 707 soporte motor trasero
- 4- 779 silentbloc anterior trapecio delantero
- 5- 780 silentbloc posterior trapecio delantero
- 6- 4153 tapa con tuerca amortiguador delantero
- 7- 2821 soporte amortiguador delantero
- 8- 4180 rodamiento soporte amortiguador
- 9- 998 capuchón amortiguador delantero
- 10- 2687 goma central para barra estabilizadora de Ø 22 mm
- 11- 2655 bieleta puntal barra estabilizadora
- 12- 4289 silentbloc soporte sub-chasis
- 13- 90015 buje rueda delantera
- 14- 96166 latiguillo freno delantero (270 mm)

### CLIO-I 1.2 - 1.4 - 1.7 - 1.8 - 1.9D y 16v.

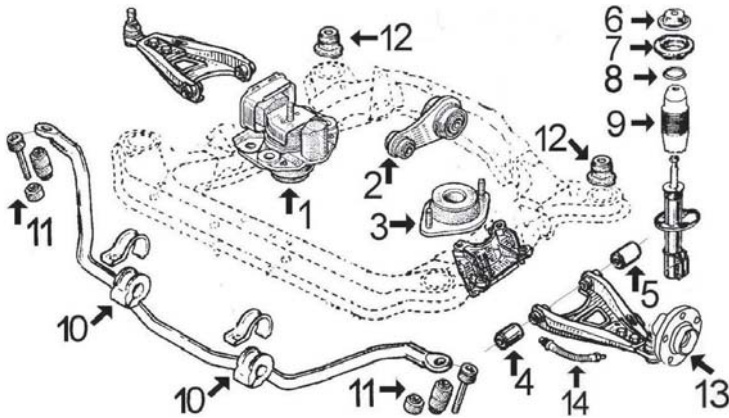

- 1- 997 soporte motor derecho 1.2-1.4-1.7-1.8 y 16v.
- 4086 soporte motor derecho 1.9 Diesel
- 2- 972 soporte motor trasero 1.2-1.4 y 1.9 Diesel
- 999 soporte motor trasero 1.7-1.8 y 16v.
- 4896 soporte motor trasero con cambio automático
- 3- 985 soporte motor izquierdo
- 4- 779 silentbloc anterior trapecio delantero 1.2-1.7-1.9D todos y 1.4 y 1.8 hasta 12/'96
- 4640 silentbloc anterior trapecio delantero 1.4 y 1.8 desde 12/'96
- 5- 780 silentbloc posterior trapecio delantero 1.2-1.7-1.9D todos y 1.4 - 1.8 hasta 12/'96
- 4640 silentbloc posterior trapecio delantero 1.4 y 1.8 desde 12/'96
- 6- 4153 tapa con tuerca amortiguador delantero
- 7- 2821 soporte amortiguador delantero 1.2-1.4
- 2769 soporte amortiguador delantero 1.7-1.8-1.9D y 16v
- 8- 4180 rodamiento soporte amortiguador
- 9- 998 capuchón amortiguador delantero
- 10- 2687 goma central para barra estabilizadora de Ø 22 mm
- 868 goma central para barra estabilizadora de Ø 23 mm
- 11- 2655 bieleta puntal barra estabilizadora
- 12- 4289 silentbloc soporte sub-chasis
- 13- 90015 buje rueda delantera 1.2-1.4
- 90020 buje rueda delantera 1.7-1.8 y Diesel
- 14- 96166 latiguillo freno delantero (270 mm)

## SUSPENSION TRASERA

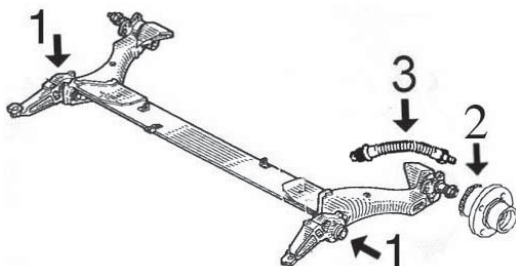

- 1- 2870 silentbloc interior articulación puente trasero
- 2904 silentbloc exterior articulación puente trasero
- 2- 90527 buje rueda trasera con rodamiento
- 3- 96155 latiguillo freno trasero (285 mm)



## RENAULT CLIO - I (hasta '98)



**707**  
soporte de motor trasero 1.1  
r.o. 7700805733



**779**  
silentbloc anterior trapecio delantero  
r.o. 7700799065



**780**  
silentbloc posterior trapecio delantero  
r.o. 7700799064

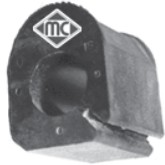

**868** para barra de Ø 23 mm  
goma central barra estabilizadora  
r.o. 7700785788



**972**  
soporte de motor trasero 1.2/1.4/DIESEL  
(aluminio), r.o. 7700841151-7700800522



**985**  
soporte de motor izquierdo todos modelos  
r.o. 7700795689

**HIDRAULICO**  
(1.430 g.)



**997**  
soporte de motor derecho 1.2-1.4-1.7-1.8-16v  
r.o. 7700805123



**998**  
capuchón amortiguador delantero  
r.o. 7700802667



**999**  
soporte de motor trasero 1.7 / 1.8 / 16v.  
r.o. 7700832262-7700805120



**2655**  
bieleta puntal barra estabilizadora  
r.o. 7700799404

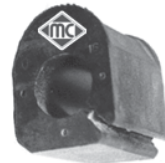

**2687** para barra de Ø 22 mm  
goma central barra estabilizadora  
r.o. 7700798053



**2769**  
soporte amortiguador delantero 1.7-1.8-16v y Diesel, r.o. 7700827436



**2821**  
soporte amortiguador delantero 1.1-1.2-1.4  
r.o. 7700827435



**2870** 43x77x28x28  
silentbloc interior tren trasero  
r.o. no hay despiece



**2904** 43x77x35x35  
silentbloc exterior tren trasero  
r.o. no hay despiece

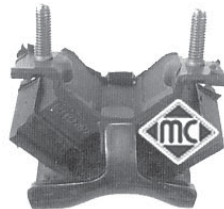

**2953**  
soporte de motor derecho 1.1  
r.o. 7700795687

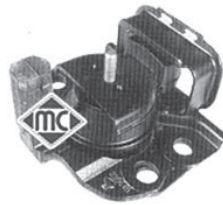

**4086**  
soporte motor derecho 1.9 Diesel  
r.o. 7700818994



**4153**  
tapa con tuerca amortiguador delantero  
r.o. 7700426450



**4155**  
soporte de motor izquierdo 1.1  
r.o. 7700795688









**4180**  
rodamiento soporte amortiguador  
r.o. 6001025850



**4289**  
silentbloc soporte cuna delantera  
r.o. 7700801875

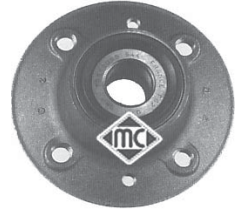

## RENAULT CLIO - I (hasta '98)

<p><b>¡nuevo!</b></p>  <p><b>4640</b> silentbloc trapecio delantero desde 12/'96 r.o. 7700799066</p>	<p><b>¡nuevo!</b></p>  <p><b>4896</b> soporte motor trasero modelos con <b>cambio automático</b>, r.o. 7700414827</p>	 <p><b>90015</b> bujе de rueda delantera 1.1-1.2-1.4 (<b>cuello retén de Ø 46 mm</b>), r.o. 7700719140</p>
 <p><b>90020</b> bujе de rueda delantera 1.7-1.8-16v y 1.9D (<b>cuello retén de Ø 52 mm</b>), r.o. 7700768319</p>	 <p><b>90527</b> bujе rueda trasera <b>con rodamiento</b> r.o. 7701204692</p>	 <p><b>96166</b> latiguillo freno delantero (270 mm) r.o. 7700804356</p>
 <p><b>96155</b> latiguillo freno trasero (285 mm) r.o. 7700804814</p>		

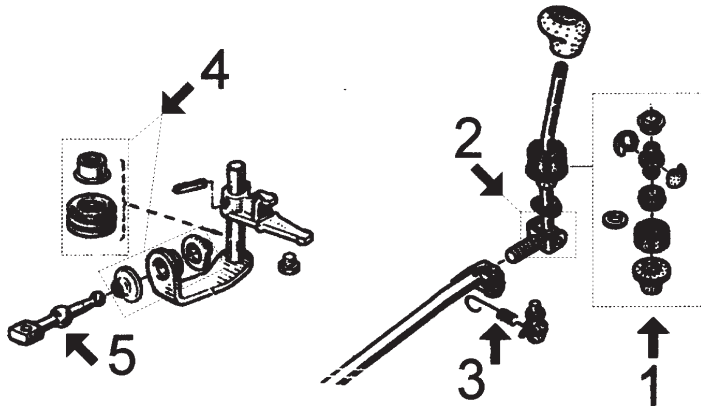
ARTICULACIONES PALANCA DE CAMBIO:

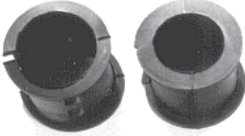

- 1- 516 juego casquillos rótula palanca
- 2- 2797 juego pasador y casquillos eje inferior palanca
- 3- 2372 muelle de retorno completo
- 4- 908 juego casquillos y retén selector
- 5- 2883 bieleta del selector

 <p><b>516</b> juego casquillos rótula palanca r.o. 7700464111</p>	 <p><b>2797</b> juego casquillos y pasador eje palanca r.o. no hay despiece</p>	 <p><b>2372</b> muelle de retorno palanca completo r.o. 7701468199</p>
 <p><b>908</b> juego casquillos-retén extremo palanca de cambio, r.o. 7700679960+7703087163</p>	 <p><b>2883</b> bieleta selector de velocidades completa r.o. 7700875584+7700872205+7700743133</p>	 <p><b>498</b> juego serreta pedal embrague completo r.o. 7700679621</p>
 <p><b>4297</b> horquilla embrague 1.9D hasta '96 r.o.</p>	 <p><b>4677</b> horquilla embrague 1.9D desde '96 r.o. 7700861585</p>	 <p><b>1350 kit</b>                      <b>350</b> fuelle fuelle cremallera manual r.o. 7700678649</p>
 <p><b>1561</b> fuelle cremallera asistida r.o. 7700706007</p>	 <p><b>2316</b> juego gomas sujeción cremallera asistida r.o. 7700778304+7700662571</p>	 <p><b>444</b> casquillo cremallera manual r.o. 7704000926</p>

## RENAULT CLIO - I (hasta '98)

 <p><b>1432</b> kit rep. transmisión l/rda. 1.2/1.4/DIESEL (homocinética Ø82 mm) r.o. 7701467125</p>	 <p><b>1555</b> kit rep. transmisión l/rda. 1.2/1.4/DIESEL (homocinética Ø86 mm) r.o. 7701466122</p>	 <p><b>1732-E</b> kit rep. transmisión l/rda. 1.7/1.8/16v. <b>Se puede montar con cono 7701033432</b></p>
 <p><b>1431</b> kit rep. transmisión lado rueda 1.1 r.o. 7700466120</p>	 <p><b>1128</b> fuelle transmisión derecha lado cambio r.o. 7701469389</p>	 <p><b>1523</b> kit rep. transmisión derecha l/cambio r.o. 7701465021</p>
 <p><b>1537</b> <span style="float: right;">Ø 25.8 mm</span> kit rep. transmis. izqd. l/cbo. completo con rodamiento, r.o. 7701462100</p>	 <p><b>1763</b> <span style="float: right;">Ø 23.8 mm</span> kit rep. transmis. izqd. l/cbo. completo con rodamiento, r.o. 7701464129</p>	 <p><b>2849</b> polea cigüeñal 1.9 Diesel <b>6 canales</b> r.o. 7700112999 (7700724249)</p>
 <p><b>4664</b> polea cigüeñal 1.9 Diesel r.o. 7700856673</p>	 <p><b>584</b> soporte tubo de escape hasta '95 r.o. 7700779356</p>	 <p><b>2763</b> soporte tubo de escape desde '95 r.o. 7700816862-7700828897</p>
 <p><b>2381</b> <span style="float: right;">Ø 52 x 67 mm</span> junta cónica tubo de escape 1.1/1.2/1.4/D r.o. 7700797807</p>	 <p><b>2382</b> <span style="float: right;">Ø 73 x 90 mm</span> junta cónica tubo de escape 1.7/1.8 r.o. 7700766353</p>	 <p><b>2890</b> <span style="float: right;">Ø 85 x 103 mm</span> junta cónica tubo de escape 16v r.o. 6001021335</p>
 <p><b>748</b> collarín enlace tubo de escape Ø 66 mm r.o. 7701459194</p>	 <p><b>670</b> tapón cárter aceite r.o. 7903075033</p>	 <p><b>832</b> jgo reparación membrana depresor Diesel r.o.</p>
 <p><b>4100</b> soporte carburador 1.2-1.4 r.o. 7700852033</p>	 <p><b>3617</b> tapón llenado aceite motor 1.9 Diesel r.o. 7700110770</p>	 <p><b>417</b> cubrepedal freno y embrague r.o. 7700680386</p>



## RENAULT CLIO-II

### CANALIZACIONES DE AGUA:

**CLIO-II 1.2 gasolina hasta '2/99 (motor D7F-710)**

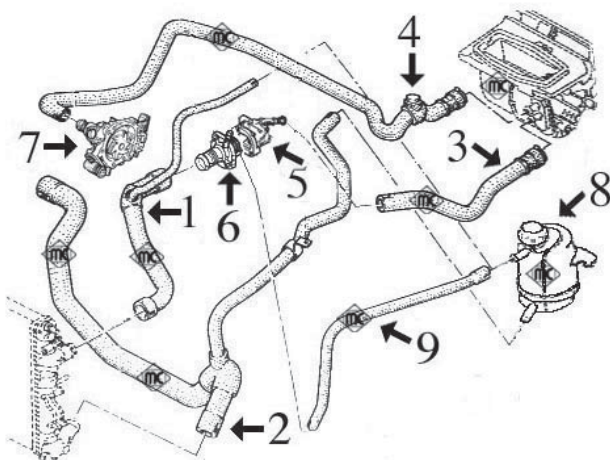

- 1- 8715 mgto superior radiador hasta 7/'98  
8739 mgto superior radiador desde 7/'98 hasta 2/'99
- 2- 8718 mgto inferior radiador
- 3- 8716 mgto de cuerpo termostato a calefactor
- 4- 8717 mgto de bomba de agua a calefactor
- 5- 3156 cuerpo de termostato (metálico) hasta 6/'98  
3669 cuerpo completo (plástico) con tapa y termostato desde 6/'98
- 6- 3147 tapa de aluminio con termostato hasta 6/'98  
(desde 6/'98 esta incorporada al cuerpo termostato ref. MC-3669)
- 7- 3033 boquilla metálica en tapa bomba de agua
- 8- 3563 tapón botella de expansión (1.4 bar)  
3567 botella de expansión
- 9- 117 mgto de botella a tapa termostato hasta 7/'98  
cortar de rollo MC-117 (Ø 10x17 mm)

**CLIO-II 1.2 gasolina desde '2/99:**

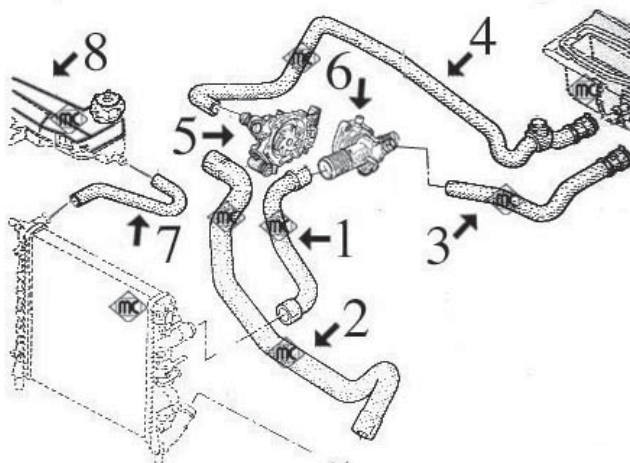

- 1- 8715 mgto superior radiador
- 2- 8713 mgto inferior radiador
- 3- 8716 mgto de cuerpo termostato a calefactor
- 4- 8717 mgto de bomba de agua a calefactor
- 5- 3033 boquilla metálica en tapa bomba de agua
- 6- 3669 cuerpo completo (plástico) con tapa y termostato
- 7- 8714 mgto de radiador a botella expansión
- 8- 3563 tapón botella de expansión (1.4 bar)  
3570 botella de expansión

**CLIO-II 1.4/1.6 gasolina 8 válvulas (motores E7J y K7M):**

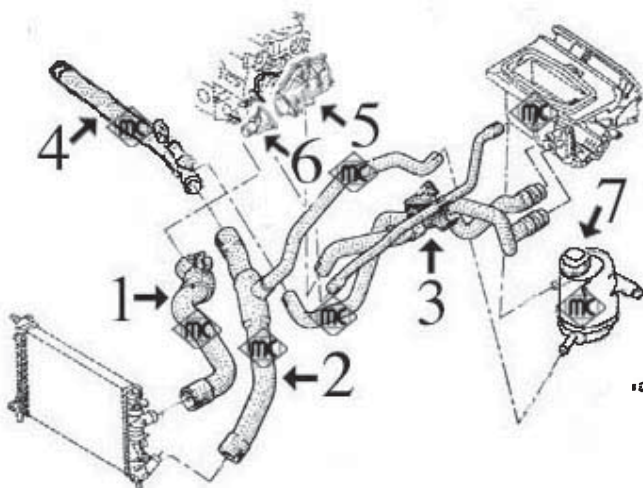

- 1- 8720 mgto superior radiador
- 2- 8721 mgto inferior radiador
- 3- 8722 mgto triple de calefactor
- 4- 3146 tubo de agua metálico
- 5- 3148 boquilla metálica en tapa aluminio
- 6- 3119 tapa de termostato
- 7- 3563 tapón botella de expansión (1.4 bar)  
3567 botella de expansión



8818 jgo mgto desvaporizadores 1.4

## RENAULT CLIO-II

CLIO-II 1.4-1.6 gasolina-16 válvulas (motores K4M-K4J):

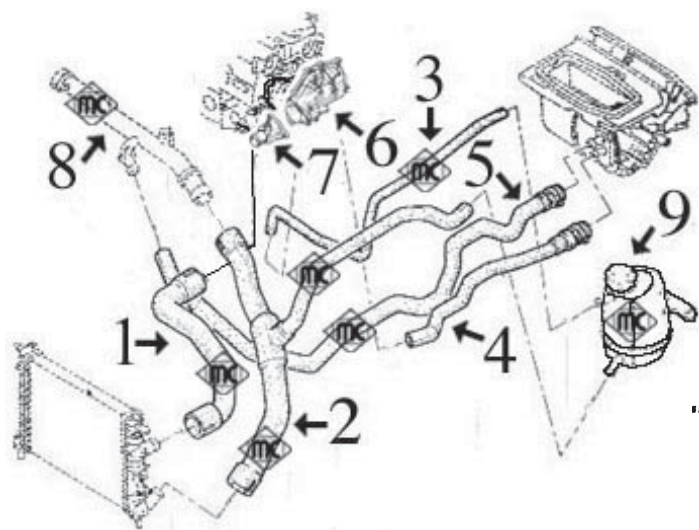

- 1- 8746 mgto superior radiador
- 2- 8747 mgto inferior radiador
- 3- 8758 mgto de botella a tapa de termostato
- 4- 8748 mgto de calefactor a cuerpo de termostato
- 5- 8754 mgto de calefactor a tubo rígido
- 6- 3148 boquilla metálica en cuerpo de termostato
- 7- 3119 tapa de termostato
- 8- 3663 tubo rígido (plástico)
- 9- 3563 tapón botella de expansión (1.4 bar)
- 3567 botella de expansión



- ~~8750~~ mgto desvaporizador

CLIO-II 1.9 Diesel (motor F8Q) versiones SIN INTERCAMBIADOR en filtro de aceite (sin aire acondicionado)

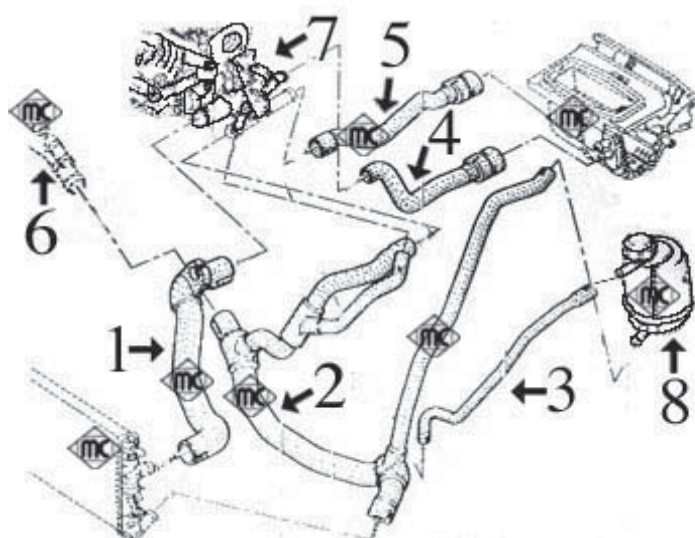

- 1- 8723 mgto superior radiador
- 2- 8724 mgto inferior radiador
- 3- 8726 mgto de botella a cuerpo de termostato
- 4- 8728 mgto inferior de calefactor a cuerpo termostato
- 5- 8729 mgto superior de calefactor a cuerpo termostato
- 6- 3662 tubo de agua en bloque motor (plástico)
- 7- 3569 cuerpo completo con termostato y accesorios
- 8- 3563 tapón botella de expansión (1.4 bar)
- 3567 botella de expansión

## RENAULT CLIO-II

CLIO-II 1.9 Diesel (motor F8Q) versiones CON INTERCAMBIADOR en filtro de aceite (con aire acondicionado)

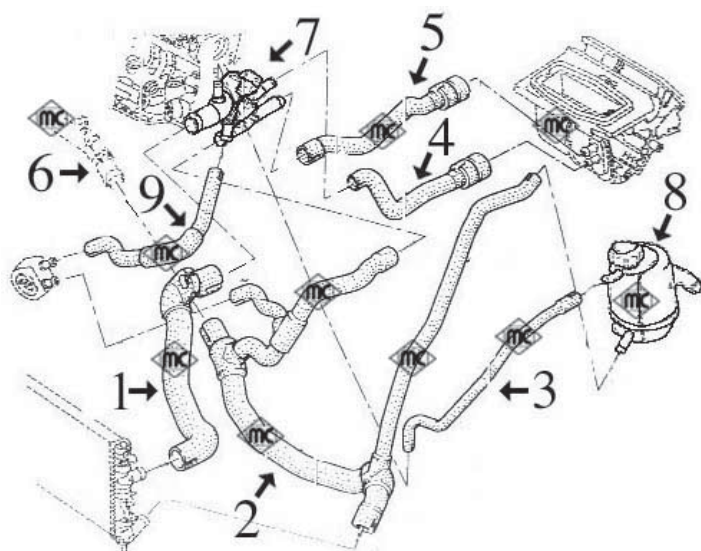

- 1- 8723 mgto superior radiador
- 2- 8725 mgto inferior radiador
- 3- 8726 mgto de botella a cuerpo de termostato
- 4- 8728 mgto inferior de calefactor a cuerpo termostato
- 5- 8729 mgto superior de calefactor a cuerpo termostato
- 6- 3662 tubo de agua en bloque motor (plástico)
- 7- 3569 cuerpo completo con accesorios (con termostato)
- 3624 cuerpo completo con accesorios (sin termostato)
- 8- 3563 tapón botella de expansión (1.4 bar)
- 3567 botella de expansión
- 9- 8727 mgto de intercambiador a cuerpo termostato

CLIO-II 1.9 Diesel DTi (motor F9Q, desde '99)

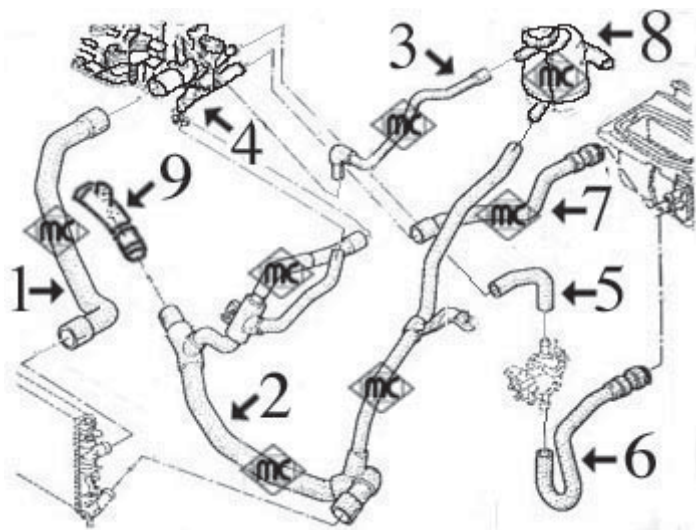

- 1- 8730 mgto superior radiador
- 2- 8732 mgto inferior radiador hasta 12/'00
- 8731 mgto inferior radiador desde 12/'00
- 3- 8726 mgto de botella a cuerpo de termostato
- 4- 3569 cuerpo completo con accesorios (con termostato) hasta 12/'00
- 3624 cuerpo completo con accesorios (sin termostato) hasta 12/'00
- 3645 cuerpo de termostato completo desde 12/'00 con termostato de 89°
- 3661 cuerpo de termostato completo desde 12/'00 con termostato de 83°
- 5- 8734 mgto de cuerpo termostato a termoinmensor
- 6- 8719 mgto de termoinmensor a calefactor
- 7- 8735 mgto de calefactor a cuerpo termostato
- 8- 3563 tapón botella de expansión (1.4 bar)
- 3567 botella de expansión
- 9- 3662 tubo de agua en bloque motor (plástico)



## RENAULT CLIO-II

CLIO-II 1.5 Diesel-DCi (motor K9K):

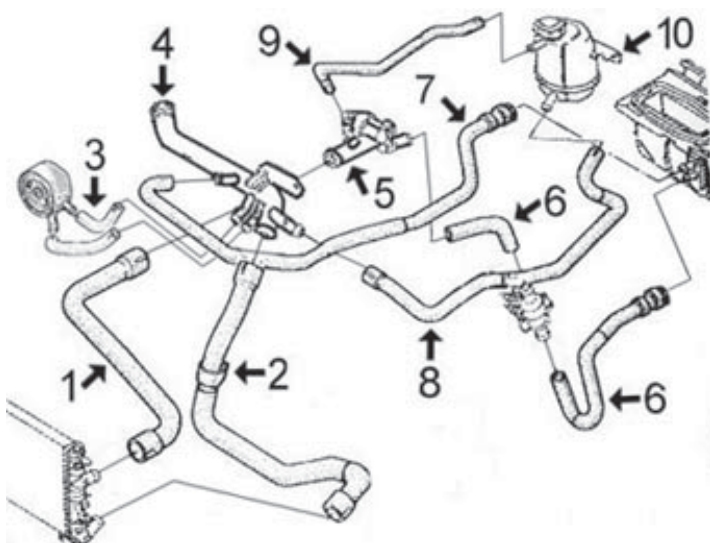

- 1- 8933 mgto superior radiador
- 2- 8948 mgto inferior radiador
- 3- 8941 jgo mgto a intercambiador
- 4- 3187 tubo de agua
- 5- 3670 caja de termostato completa hasta 7/'03
- 3679 caja de termostato completa desde 7/'03
- 6- 8947 jgo mgto de caja termostato a termoinmensor y a calefactor
- 7- 8939 mgto de calefactor a tubo
- 8- 8949 mgto de botella a tubo
- 9- 8726 mgto de sobrante de botella a caja termostato
- 10- 3563 tapón botella de expansión
- 3567 botella de expansión



MANGUITOS DESVAPORIZADORES motor F8Q 1.9D:

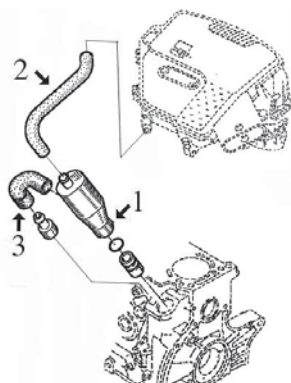

- 1- 3714 decantador completo con junta
- 2- 8751 mgto de decantador a caja filtro
- 3- 8666 mgto de decantador a bloque motor



MANGUITOS DESVAPORIZADORES motor F9Q 1.9DTi:

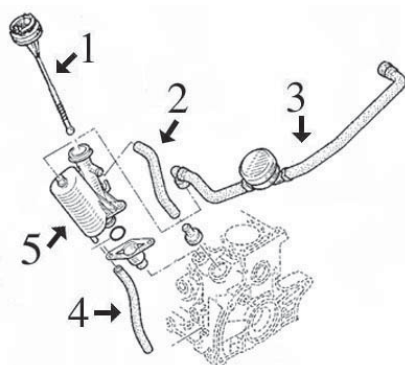

- 1- 4725 varilla nivel aceite
- 2- 8752 mgto superior de caja reguladora a bloque
- 3- 9095 mgto de caja reguladora a culata con válvula
- 4- 8753 mgto inferior de caja reguladora a bloque
- 5- 3717 decantador completo con junta



MANGUITOS DESVAPORIZADORES motor K9K-1.5DCi:

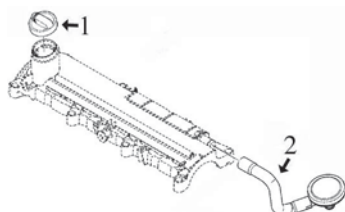

- 1- 3617 tapón llenado aceite motor
- 2- 3680 válvula desvaporizadora con manguito a tapa



## RENAULT CLIO-II



**8666**  
mgto desvaporizador 1.9 Diesel  
r.o.



**8713**  
mgto inferior radiador 1.2  
r.o.



**8714**  
mgto de radiador a botella expansión 1.2



**8715**  
mgto superior radiador 1.2 desde '99  
r.o.



**8716**  
mgto de termostato a calefactor 1.2  
r.o.



**8717**  
mgto de bomba a calefactor 1.2  
r.o.



**8718**  
mgto inferior radiador 1.2  
r.o.



**8719**  
mgto de termoinmensor a calefactor 1.9 DTi  
r.o.



**8720**  
mgto superior radiador 1.4 - 1.6  
r.o.



**8721**  
mgto inferior radiador 1.4 - 1.6  
r.o.



**8722**  
conjunto mgto. de calefactor 1.4 - 1.6  
r.o.



**8723**  
mgto superior radiador 1.9 Diesel  
r.o.



**8724**  
mgto inferior radiador 1.9 Diesel  
r.o.



**8725**  
mgto inferior radiador 1.9 Diesel (aire ac.)  
r.o.



**8726**  
mgto de botella a cuerpo termostato 1.9 D  
r.o.



**8727**  
mgto de intercambiador a termostato 1.9 D  
r.o.



**8728**  
mgto calefactor a termostato 1.9 Diesel  
r.o.



**8729**  
mgto calefactor a termostato 1.9 Diesel  
r.o.



**8730**  
mgto superior radiador 1.9 DTi  
r.o.



**8731**  
mgto inferior radiador 1.9 DTi desde 12/'00  
r.o.

## RENAULT CLIO-II



**8732**  
mgto inferior radiador 1.9 DTi hasta 12/'00  
r.o.



**8734**  
mgto de termostato a termoinmensor 1.9DTi  
r.o.



**8735**  
mgto de calefactor a termostato 1.9 DTi  
r.o.



**8739**  
mgto superior radiador 1.2 desde '99  
r.o.



**8746**  
mgto superior radiador 1.4-1.6/16v  
r.o.



**8747**  
mgto inferior radiador 1.4-1.6/16v  
r.o.



**8748**  
mgto de calefactor a termostato 1.4-1.6/16v  
r.o.



**8750**  
mgto desvaporizador 1.4-1.6/16v  
r.o.



**8751**  
mgto desvaporizador 1.9 Diesel  
r.o.



**8752**  
mgto desvaporizador 1.9 DTi  
r.o.



**8753**  
mgto desvaporizador 1.9 DTi  
r.o.



**8754**  
mgto de calefactor a tubo 1.4-1.6/16v  
r.o.



**8758**  
mgto de botella a tapa termostato 1.4-1.6/16v  
r.o.



**8818**  
jgo mgto desvaporizadores 1.4-1.6  
r.o.



**8933**  
mgto sup radiador 1.5DCi  
r.o.



**8939**  
mgto de tubo a calefactor 1.5DCi  
r.o.



**8941**  
jgo mgto intercambiador 1.5DCi  
r.o.



**8947**  
jgo mgto de caja a termoinmensor y a  
calefactor, r.o.



**8948**  
mgto inferior radiador 1.5DCi  
r.o.



**8949**  
mgto de tubo a botella 1.5DCi  
r.o.



**9095**  
mgto desvaporizador con válvula 1.9DTi  
r.o.8200136128-80200063371

## RENAULT CLIO-II



**3033** Ø 20 mm  
boquilla metálica en bomba de agua 1.2  
r.o. no hay despiece



**3119**  
tapa de termostato 1.4-1.6-2.0  
r.o. 7700866387



**3146**  
tubo de agua metálico 1.4-1.6  
r.o. 7700869985



**3147**  
cuerpo de termostato 1.2 hasta 6/98  
r.o. 7700864962



**3148** Ø 18 mm  
boquilla metálica en cuerpo termost. 1.4-1.6-  
-2.0, r.o. 7700104134



**3156**  
tapa con termostato 1.2 hasta 6/98  
r.o. 7700868980

**¡Nuevo!**



**3187**  
tubo de agua 1.5DCi (K9K) hasta 7/03  
r.o.



**3563**  
tapón botella de expansión (1.4 bar)  
r.o. 8200048024



**3567**  
botella de expansión 1.2-1.4-1.6-1.9D-  
-1.9DTi, r.o. 7701470460



**3569** CON TERMOSTATO  
cuerpo termost. completo con accesorios  
1.9D-DTi, r.o. 7701474249



**3570**  
botella de expansión 1.2 desde '99  
r.o. 7701471925



**3624** SIN TERMOSTATO  
cuerpo termost. completo con accesorios  
1.9D-DTi, r.o. 8200065390+8200065394

**¡Nuevo!**



**3645**  
caja con termostato de 89° 1.9D desde 12/00  
r.o. 8200074346

**¡Nuevo!**

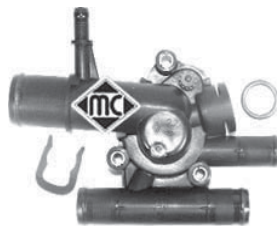

**3661**  
caja con termostato de 83° 1.9D desde 12/00  
r.o. 8200074349

**¡Nuevo!**



**3662**  
boquilla entrada agua a motor 1.9D-1.9Dti  
y 2.0, r.o. 7700873948

**¡Nuevo!**



**3663**  
tubo de agua 1.4/16v-1.6/16v  
r.o. 8200134513

**¡Nuevo!**



**3669**  
caja con termostato 1.2 desde 6/98  
r.o. 7700110716

**¡Nuevo!**

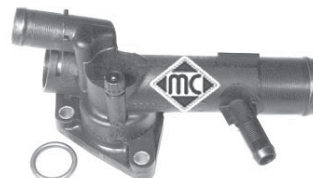

**3670**  
caja con termostato 1.5DCi hasta 7/03  
r.o. 8200374994

**¡Nuevo!**

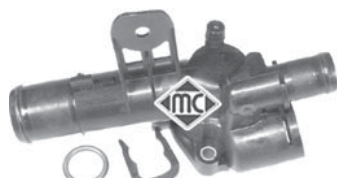

**3679**  
caja con termostato 1.5DCi desde 7/03  
r.o. 8200267349

**¡Nuevo!**



**3680**  
válvula desvaporizadora 1.5DCi  
r.o.

**¡Nuevo!**



**3714**  
decantador completo con junta 1.9D-F8Q  
y 2.0 gasolina, r.o.

**RENAULT CLIO-II**

**nuevo!**



**3717**

decantador completo con junta 1.9D-F9Q

r.o.



## SUSPENSION DELANTERA y SOPORTES DE MOTOR:

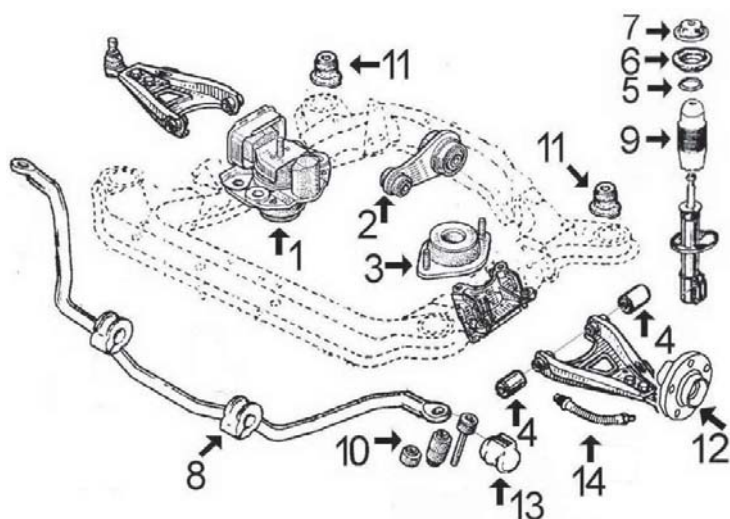

- 1- 4092 soporte motor derecho 1.2-1.2/16v
- 4028 soporte motor derecho 1.4-1.4/16v-1.6-1.6/16v y 1.9Diesel F8Q
- 997 soporte motor derecho 1.9DTi
- 4158 soporte motor derecho 1.5DCi
- 2- 4071 tirante motor trasero 1.2/8v hasta 5/'99
- 4073 tirante motor trasero 1.2/8v desde 5/'99 hasta 6/'01
- 4675 tirante motor trasero 1.2/8v desde 6/'01
- 4073 tirante motor trasero 1.2/16v
- 4071 tirante motor trasero 1.4/8v-1.6/8v
- 4073 tirante motor trasero 1.4/16v-1.6/16v hasta 6/'01
- 4675 tirante motor trasero 1.4/16v desde 6/'01
- 4676 tirante motor trasero 1.6/16v desde 6/'01
- 4071 tirante motor trasero 1.9D hasta 10/'99 (F8Q)
- 4073 tirante motor trasero 1.9D desde 10/'99 (F8Q)
- 4093 tirante motor trasero 1.9DTi hasta '00 (F9Q)
- 4102 tirante motor trasero 1.9DTi desde '00 hasta 6/'01
- 4676 tirante motor trasero 1.9DTi desde 6/'01
- 4073 tirante motor trasero 1.5Dci hasta '02
- 4676 tirante motor trasero 1.5Dci d/'02 hasta 7/'03
- 4675 tirante motor trasero 1.5Dci desde 7/'03
- 3- 973 soporte motor izquierdo todos modelos
- 4- 4094 silentbloc brazo suspensión
- 5- 4180 rodamiento soporte amortiguador
- 6- 4110 soporte amortiguador
- 7- 4153 tapa superior amortiguador con tuerca autoblocante
- 8- 868 goma central para barra estabilizadora de Ø 23 mm
- 4167 goma central para barra estabilizadora de Ø 24 mm
- 9- 998 capuchón amortiguador
- 10- 2655 bieleta puntal barra estabilizadora todos salvo 2.0
- 11- 4289 silentbloc sub-chasis
- 12- 90015 buje rueda delantera 21 estrías, cuello retén de Ø 46 mm
- 90020 buje rueda delantera 21 estrías, cuello retén de Ø 52 mm
- 90068 buje rueda delantera 23 estrías
- 13- 2483 goma puntal barra estabilizadora 2.0
- 14- 96113 latiguillo freno delantero (345 mm)

## SUSPENSION TRASERA:

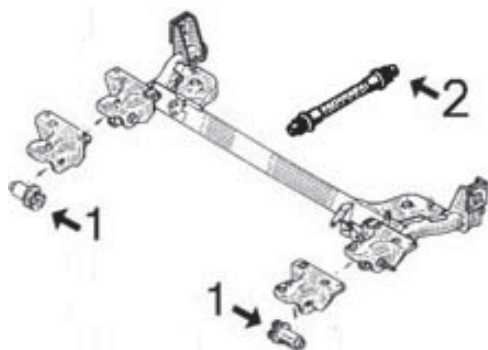

- 1- 4156 silentbloc soporte puente trasero
- 2- 96114 latiguillo freno trasero (195 mm)

## RENAULT CLIO-II



**868**  
goma central para barra establz. de Ø 23 mm  
r.o. 7700785788



**973**  
soporte motor izquierdo  
r.o. 7700788318



**997**  
soporte motor derecho 1.9DTi  
r.o. 7700805123



**998**  
capuchón amortiguador delantero  
r.o. 7700802667-7700428440



**2483**  
goma puntal barra estabilizadora 2.0  
r.o. 7700784171



**2655**  
bioleta puntal barra estabilizadora  
r.o. 7700799404



**4028** hidráulico  
soporte motor derecho 1.4-1.6-1.9 D  
r.o. 7700434370



**4071**  
tirante motor trasero 1.9 DTi  
r.o. 7700415095



**4073**  
tirante motor trasero 1.4/16v-1.6/16v-1.5Dci  
r.o. 7700437854



**4092**  
soporte motor derecho 1.2  
r.o. 7700415087



**4093**  
tirante motor trasero 1.9 DTi hasta '00  
r.o. 7700832264



**4094**  
silentbloc trapecio delantero  
r.o. 7700424399-7700419249



**4102**  
tirante motor trasero 1.9 DTi  
r.o. 7700432031-8200100116-8200148388



**4110**  
soporte amortiguador delantero  
r.o. 7700829529



**4153**  
tuerca superior amortiguador delantero  
r.o.



**4156**  
silentbloc puente trasero  
r.o. 8200042594



**4158**  
soporte motor derecho 1.5 DCi  
r.o. 8200170361



**4167**  
goma central para barra establz. de Ø 24  
r.o. 7700835929



**4180**  
rodamiento soporte amortiguador delan-  
tero, r.o. 6001025850



**4289**  
silentbloc soporte sub-chasis delantero  
r.o. 7700801875

**¡nuevo!**



**4675**  
soporte motor trasero 1.2-1.5Dci desde '03  
r.o. 8200155207-8200175102

## RENAULT CLIO-II

**¡Nuevo!**



**4676**

soporte motor trasero 1.4/16v-1.6/16v y 1.5DCi, r.o. 8200151995

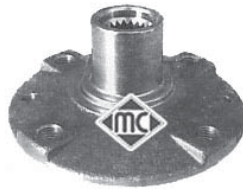

**90015**

buje rueda delantera de 21 estrias cuello retén de Ø46 mm, r.o. 7700719140



**90020**

buje rueda delantera de 21 estrias cuello retén de Ø52 mm, r.o. 7700768319



**90068**

buje rueda delantera de 23 estrias r.o. 7700415121



**96113**

latiguillo freno delantero (345 mm) r.o. 7700423975



**96114**

latiguillo freno trasero (195 mm) r.o. 7700416273

# RENAULT CLIO-II

## ARTICULACIONES PALANCA DE CAMBIO

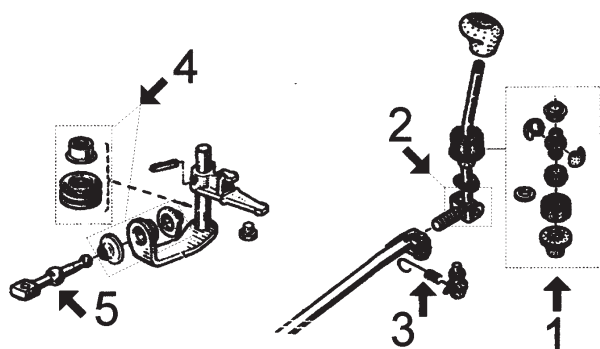

- 1- 516 juego casquillos rótula palanca
- 2- 2882 casquillo eje pasador palanca cambio
- 3- n/d muelle retorno palanca
- 4- 908 juego casquillos y retén selector
- 5- 2883 palanca del selector hasta '99
- 4287 palanca del selector desde '99

**516**

juego casquillos rótula palanca de cambio  
r.o. 7700464111



**908**

juego casquillos-retén extremo palanca de cambio, r.o. 7700679960+7703087163



**2882**

casquillo pasador eje palanca cambio  
r.o. 7700732903



**2883**

bieleta selector de velocidades hasta '99  
r.o. 7700875584+7700872205+7700743133



**4287**

bieleta selector de velocidades desde '99  
r.o. 7700102476



**4297**

horquilla embrague completa 1.9DF8Q  
r.o. 7700725720+7700715851



**4677**

horquilla embrague completa 1.9DF9Q  
r.o. 7700861585

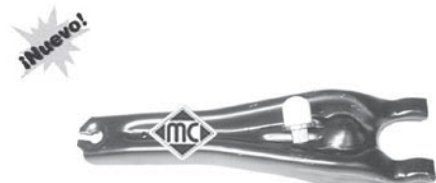

**1356**

fuelle derecho cremallera asistida "TRW"  
r.o. 7701469497-6000025546



**1530**

fuelle izquierdo cremallera asistida "TRW"  
r.o. 7701471141



**1558**

fuelle cremallera asistida "SMI" (dcho e izqd)  
r.o. 7701469496



**1647**

fuelle cremallera manual  
r.o. 7701470753



**1432**

palier de Ø 31 mm  
kit rep. transmisión l/rda 1.2-1.4-1.9  
r.o. 7701467125



**1607**

palier de Ø 35 mm  
kit rep. transmisión l/rueda 1.9D  
r.o.



**1523**

kit rep. transmisión derecha l/cambio 1.4  
hasta '99, r.o.



**1559**

kit rep. transmisión derecha l/cambio 1.2  
todos y 1.4-1.9 desde '99, r.o.





## RENAULT CLIO-II



**1537** rodamiento de Ø 25,8 mm  
kit rep. transmisión izquierda l/cambio 1.2  
todos y 1.9 hasta '6/99, r.o.



**2304** rodamiento de Ø 28,0 mm  
kit rep. transmisión izquierda l/cambio 1.9  
desde 7/'99, r.o.



**1533**  
kit rep. transmisión derecha l/cambio 1.9  
hasta '99, r.o. 7701469418



**3619**  
tapón llenado aceite motor 1.4/16v-1.6/16v  
r.o. 7700111741



**4725**  
varilla nivel aceite 1.9DTi  
r.o. 8200138515



**3617**  
tapón llenado aceite motor 1.9D-1.5D  
r.o. 7700110770



**584**  
soporte trasero tubo escape  
r.o. 7700779356



**2722**  
soporte central tubo escape  
r.o. 7700849461



**4114**  
soporte intermedio tubo escape  
r.o. 7700424341

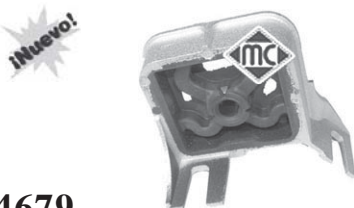

**4679**  
soporte escape 1.5DCi  
r.o. 7700435270



**4166** Ø 66 x 52 mm  
junta cónica escape a colector 1.9 Diesel  
r.o. 8200035310



**4642**  
juego juntas en tubo entrada Turbo 1.5DCi  
r.o. monta en 8200404193



**2849**  
polea cigueñal 1.9 D (motor F8Q)  
r.o. 7700112999



**4664**  
polea cigueñal 1.9 D (motor F8Q)  
r.o. 7700856673



**4163**  
polea cigueñal 1.9DTi (motor F9Q)  
r.o. 7700115309



**4455**  
polea cigueñal 1.9DTi (motor F9Q)  
r.o. 7700115766



**4666** 7 canales  
polea cigueñal 1.9DTi (motor F9Q)  
r.o. 8200297937



**4162**  
polea cigueñal 1.5 DCi hasta 7/'03  
r.o. 8200185800



**4735**  
polea cigueñal 1.5 DCi desde 7/'03  
r.o. 8200477938

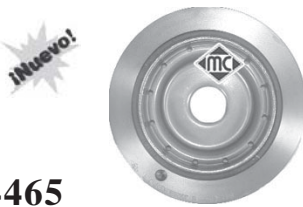

**4465**  
polea cigueñal 1.4/16v-1.6/16v  
r.o. 8200313231



**4763**  
polea cigueñal 2.0 (F4R)  
r.o. 8200386460-7700116269

## RENAULT CLIO-II

<p><i><b>¡Nuevo!</b></i></p>  <p><b>4728</b> polea alternador <b>5 canales SOLIDA</b> r.o.</p>	<p><i><b>¡Nuevo!</b></i></p>  <p><b>4729</b> polea alternador <b>6 canales SOLIDA</b> r.o.</p>	<p><i><b>¡Nuevo!</b></i></p>  <p><b>4641</b> juego tapas arboles de levas 1.4-1.6/16v r.o.7700106271+7700274026</p>
<p><i><b>¡Nuevo!</b></i></p>  <p><b>4947</b> polea alternador <b>5 canales DESEMBRAGABLE</b>, r.o. 8200113636</p>	<p><i><b>¡Nuevo!</b></i></p>  <p><b>4948</b> polea alternador <b>6 canales DESEMBRAGABLE</b>, r.o. 7700110616</p>	<p><i><b>¡Nuevo!</b></i></p>  <p><b>4994</b> polea árbol de levas 1.9DTi-DCi (F9Q) r.o. 7700866844-7700107401</p>
<p><i><b>¡Nuevo!</b></i></p>  <p><b>4912</b> Ø 61,00 mm polea alternador <b>de rueda libre</b> r.o.</p>	<p><i><b>¡Nuevo!</b></i></p>  <p><b>4913</b> Ø 53,30 mm polea alternador <b>de rueda libre</b> r.o.</p>	<p><i><b>¡Nuevo!</b></i></p>  <p><b>4914</b> Ø 55,40 mm polea alternador <b>de rueda libre</b> r.o.</p>
<p><i><b>¡Nuevo!</b></i></p>  <p><b>4149</b> soporte radiador r.o. 7700842041</p>	<p><b>667</b> tapón cárter de aceite 1.2-1.4 (16x150) r.o. 7703075210</p> 	<p><b>670</b> tapón cárter de aceite 1.9 r.o. 7703075033</p> 
 <p><b>4717</b> cubrepedal freno y embrague r.o. 8200183752</p>		

## CANALIZACIONES DE AGUA HASTA '96:

SPACE-II

2.0 gasolina, motor J7R desde '89 hasta '96:

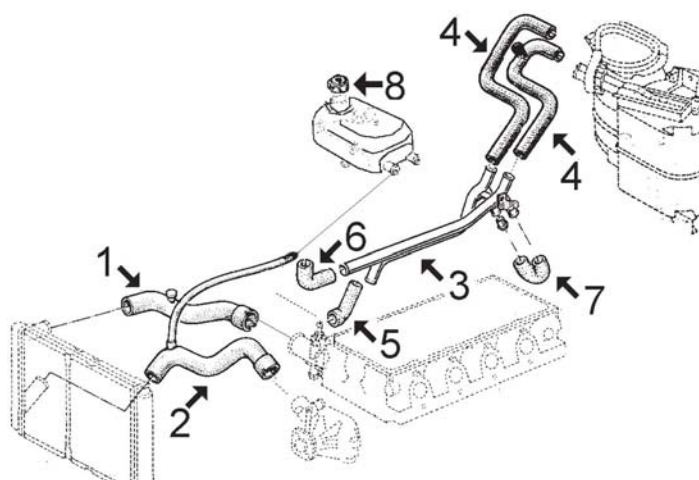

- 1- 8870 mgto superior radiador
- 2- 8856 mgto inferior radiador
- 3- 3006 tubo metálico de agua
- 4- 8867 juego mgto entrada/salida calefactor
- 5- 7964 mgto de tubo a caja termostato
- 6- 7666 mgto de tubo a caja termostato
- 7- 7966 mgto unión tubo metálico
- 8- 3514 tapón botella de expansión

SPACE-II

2.1 Diesel, motor J8S de 2.068 cc desde '89 hasta '96:

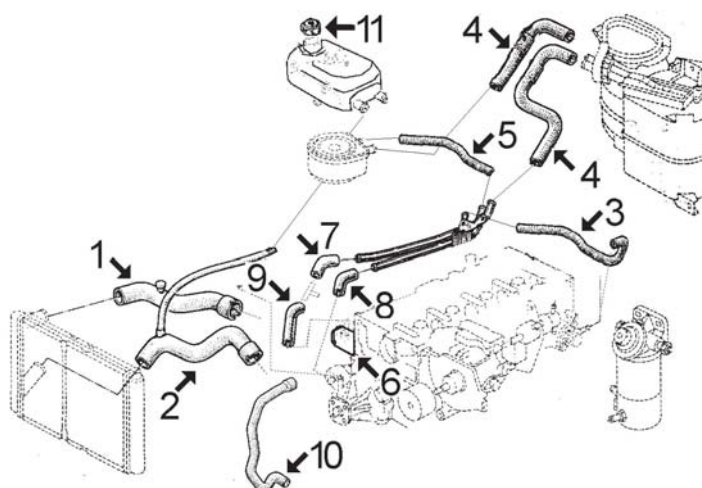

- 1- 8861 mgto superior radiador
- 2- 8856 mgto inferior radiador
- 3- 8099 mgto de tubo a culata
- 4- 8864 juego mgto entrada/salida calefactor
- 5- 8866 mgto de tubo a intercambiador
- 6- n/d tapa de termostato
- 7- 8098 mgto de tubo a caja termostato
- 8- 7998 mgto de tubo a caja termostato
- 9- 7968 mgto en caja de termostato
- 10- 8128 mgto desvaporizador
- 11- 3514 tapón botella de expansión

## RENAULT SPACE - II - III - IV

SPACE-III

2.0 gasolina motor F4R

desde '96 hasta '02:

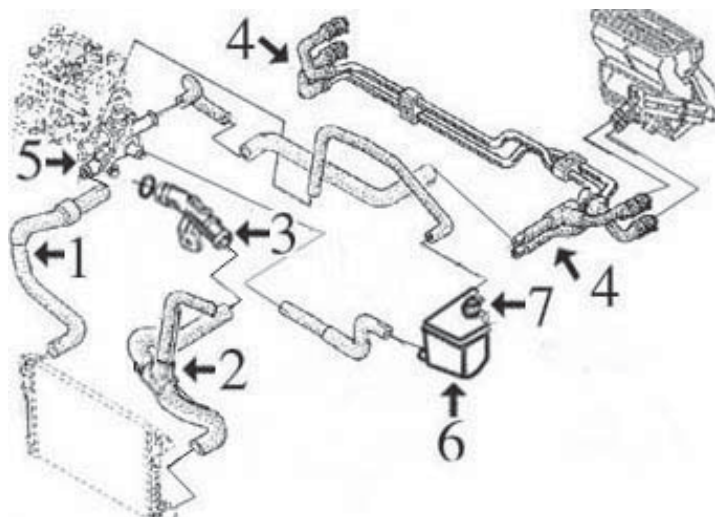

- 1- 8876 mgto superior radiador
- 2- 8885 mgto inferior radiador
- 3- 3662 boquilla entrada agua a bloque
- 4- 8903 juego mgtos entrada/salida calefactor
- 5- 3119 tapa de termostato
- 3148 boquilla metálica en caja de termostato
- 6- 3652 botella de expansión
- 7- 3563 tapón botella de expansión

SPACE-III

1.9 Diesel motor F9Q

desde '98 hasta '02:

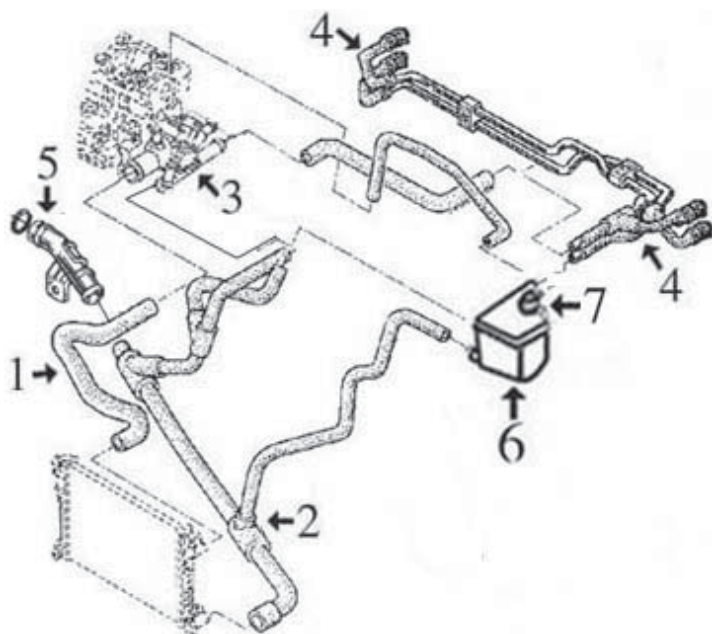

- 1- 8905 mgto superior radiador
- 2- 8906 mgto inferior radiador
- 3- 3569 caja de termostato completa hasta 3/'01
- 3645 caja de termostato completa desde 3/'01
- 4- 8903 juego mgtos entrada/salida calefactor
- 5- 3662 boquilla entrada agua a bloque
- 6- 3652 botella de expansión
- 7- 3563 tapón botella de expansión



## RENAULT SPACE - II - III - IV

**SPACE-III**

**2.2dT Diesel motor G8T**

**desde '96 hasta 12/'98:**

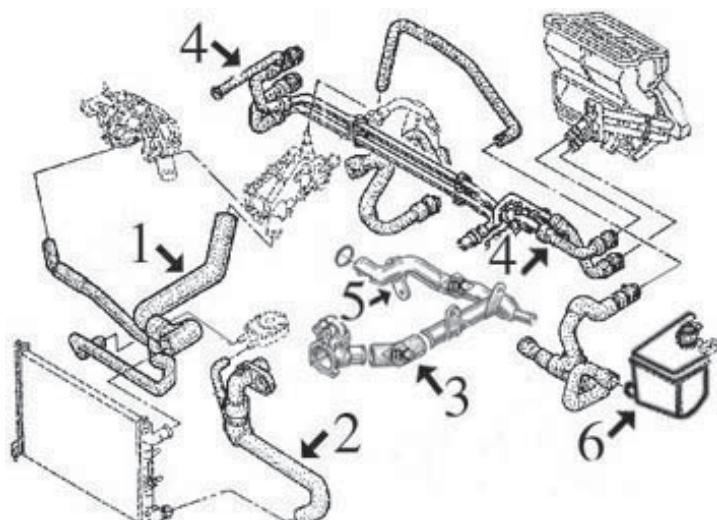

- 1- 8907 mgto superior radiador
- 2- 8908 mgto inferior radiador
- 3- 8792 mgto de tubo metálico a caja termostato
- 4- 8903 juego mgto entrada/salida calefactor
- 5- 3155 tubo de agua metálico
- 6- 3652 botella de expansión
- 3514 tapón botella de expansión

8883 juego mgto desvaporizadores 

**SPACE-III**

**2.2dT Diesel motor G8T**

**desde 12/'98:**

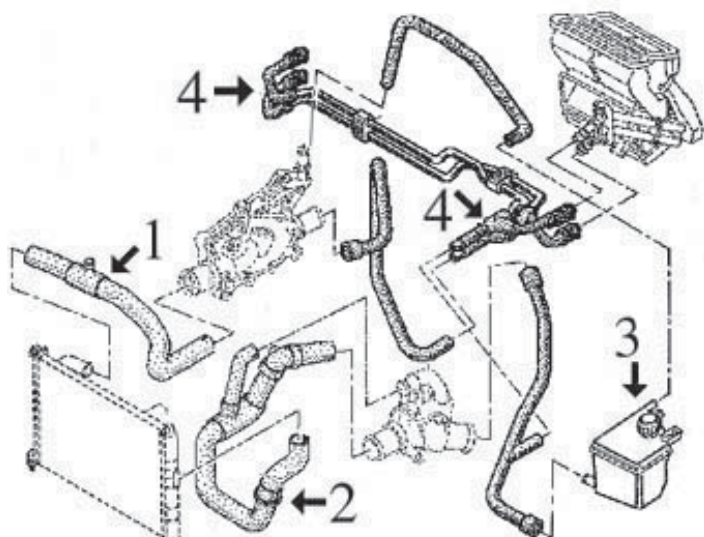

- 1- 8909 mgto superior radiador
- 2- 8910 mgto inferior radiador
- 3- 3652 botella de expansión
- 3514 tapón botella de expansión
- 4- 8903 juego mgto entrada/salida calefactor

8883 juego mgto desvaporizadores 

**SPACE-III**

**2.2dT motor Diesel G9T**

**desde '00:**

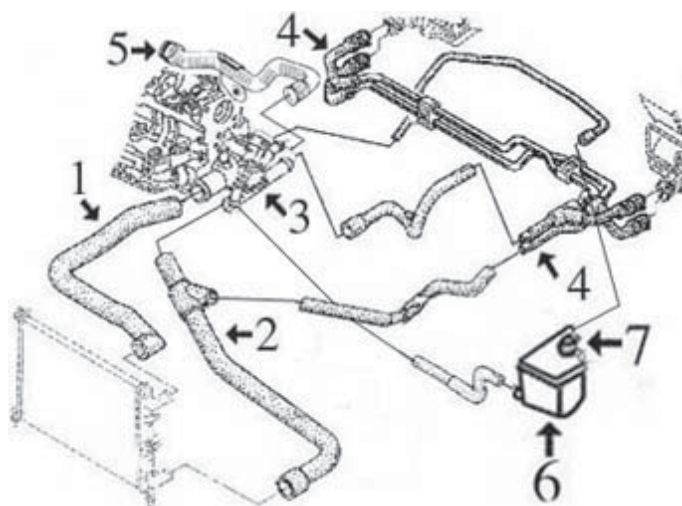

- 1- 8904 mgto superior radiador
- 2- 8902 mgto inferior radiador
- 3- 3646 caja de termostato completa
- 4- 8903 juego mgto entrada/salida calefactor
- 5- n/d tubo de agua
- 6- 3652 botella de expansión
- 7- 3514 tapón botella de expansión

## RENAULT SPACE - II - III - IV



**7666**  
mgto de tubo a caja termostato Espace-II  
2.0(J7R),r.o. 7700727746



**7964**  
mgto de tubo a caja termostato Espace-II  
2.0(J7R),r.o. 7700851815



**7966**  
mgto unión tubo metálico Espace-II 2.0  
r.o. 7705026798



**7968**  
mgto de tubo a caja termostato Espace-II  
2.1D(J8S),r.o. 7700733183



**7998**  
mgto de tubo a caja termostato Espace-II  
2.1D(J8S),r.o. 7705026323



**8098**  
mgto de tubo a caja termostato Espace-II  
2.1D(J8S),r.o. 7700742500



**8099**  
mgto de tubo a culata Espace-II 2.1D (J8S)  
r.o. 7700667779



**8128**  
mgto desvaporizador Espace-II 2.1D (J8S)  
r.o. 7700733557



**8792**  
mgto de tubo metálico a caja termostato  
Espace-III 2.2dT, r.o. 7705126973

**iNuevo!**



**8856**  
mgto inferior rad. Espace-III 2.1D (J8S)  
r.o.

**iNuevo!**



**8861**  
mgto superior rad. Espace-III 2.1D (J8S)  
r.o.

**iNuevo!**



**8864**  
jgo. mgto calefactor Espace-II 2.1D (J8S)  
r.o.

**iNuevo!**



**8866**  
mgto de tubo metálico Espace-II 2.1D (J8S)  
r.o.

**iNuevo!**



**8867**  
jgo. mgto calefactor Espace-II 2.0 (J7R)  
r.o.

**iNuevo!**



**8870**  
mgto superior rad. Espace-II 2.0 (J7R)  
r.o.

**iNuevo!**



**8876**  
mgto superior rad. Espace-III 2.0-16v (F4R)  
r.o.

**iNuevo!**



**8883**  
jgo mgto desvaporizadores 2.2dT G8T-G9T  
r.o.

**iNuevo!**



**8885**  
mgto inferior rad. Espace-III 2.0 (F4R)  
r.o.

**iNuevo!**



**8902**  
mgto inferior rad. Espace-III 2.2dT (G9T)  
r.o.

**iNuevo!**

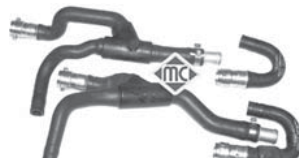





















**8903**  
jgo. mgto calefactor Espace-III 1.9D-2.0-  
r.o.

**iNuevo!**



**8904**  
mgto superior rad. Espace-III 2.2dT (G9T)  
r.o.

## RENAULT ESPACE - II - III - IV

<p><b>¡Nuevo!</b></p>  <p><b>8905</b> mgto superior rad. Espace-III 1.9D (F9Q) r.o.</p>	<p><b>¡Nuevo!</b></p>  <p><b>8906</b> mgto inferior rad. Espace-III 1.9D (F9Q) r.o.</p>	<p><b>¡Nuevo!</b></p>  <p><b>8907</b> mgto superior Espace-III 2.2dT (G8T) r.o.</p>
<p><b>¡Nuevo!</b></p>  <p><b>8908</b> mgto inferior rad. Espace-III 2.2dT (G8T) r.o.</p>	<p><b>¡Nuevo!</b></p>  <p><b>8909</b> mgto superior rad. Espace-III 2.2dT (G9T) r.o.</p>	<p><b>¡Nuevo!</b></p>  <p><b>8910</b> mgto inferior rad. Espace-III 2.2dT (G9T) r.o.</p>
<p><b>¡Nuevo!</b></p>  <p><b>9095</b> mgto desvaporizador Espace-IV 1.9D (F9Q) r.o.</p>	<p><b>3006</b> tubo de agua 2.0 motor J7R Espace-II r.o. 7700857567</p> 	<p><b>3119</b> tapa de termostato 2.0-16v r.o. 7700866387</p> 
<p><b>3148</b> boquilla en caja termostato 2.0-16v r.o. 7700104134</p> 	<p><b>3155</b> tubo de agua 2.2Diesel r.o. 7700862891</p> 	<p><b>3514</b> tapón botella de expansión Espace I-II-III r.o. 7700805031</p> 
<p><b>3563</b> tapón botella de expansión Espace-III-IV r.o. 7700805131</p> 	<p><b>3569</b> cuerpo de termostato completo 1.9D hasta '99, r.o. 7701474248</p> 	<p><b>¡Nuevo!</b></p> <p><b>3645</b> cuerpo de termostato completo 1.9D (89°) desde '99, r.o. 8200074346</p> 
<p><b>¡Nuevo!</b></p> <p><b>3646</b> cuerpo de termostato completo 2.2dT (G9T) r.o. 8200262237</p> 	<p><b>¡Nuevo!</b></p> <p><b>3652</b> botella de expansión Espace-II-III r.o. 6025371703</p> 	<p><b>¡Nuevo!</b></p> <p><b>3661</b> cuerpo de termostato completo 1.9D (83°) desde '99, r.o. 8200074349</p> 
<p><b>¡Nuevo!</b></p> <p><b>3662</b> boquilla entrada agua a bloque 1.9D r.o. 7700873948</p> 	<p><b>¡Nuevo!</b></p> <p><b>3714</b> decantador completo 1.9D-F8Q y 2.0 gasolina, r.o.</p> 	<p><b>¡Nuevo!</b></p> <p><b>3717</b> decantador completo 1.9D-F9Q r.o.</p> 



SUSPENSION DELANTERA y SOPORTES DE MOTOR:

SPACE-II desde '91 hasta '96 2.0 gasolina motor J7R  
2.1 Diesel motor J8S

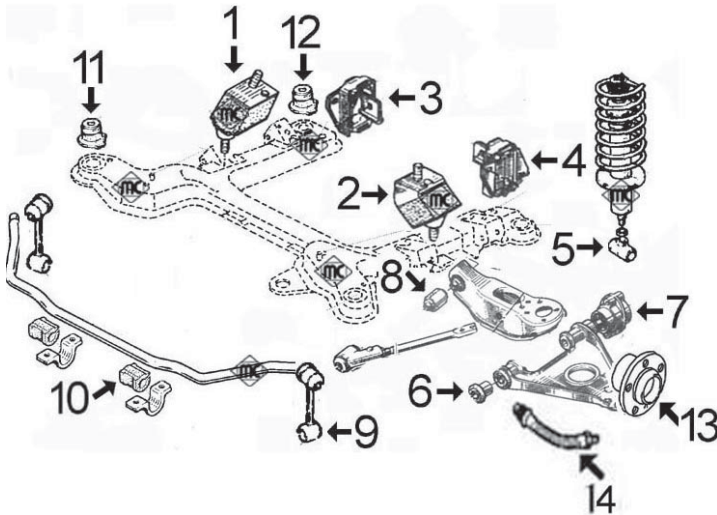

- 1- 4119 soporte motor derecho
- 2- 4120 soporte motor izquierdo
- 3- 4171 soporte derecho cambio
- 4- 4172 soporte izquierdo cambio
- 5- 211 silentbloc soporte amortiguador delantero
- 6- 4199 silentbloc anterior trapecio delantero
- 7- 4217 silentbloc posterior trapecio delantero
- 8- 4580 silentbloc brazo superior delantero
- 9- 4574 bieleta puntal barra estabilizadora
- 10- 4573 goma barra estabilizadora delantera
- 11- 777 silentbloc posterior sub-chasis delantero
- 12- 776 silentbloc anterior sub-chasis delantero
- 13- 90033 buje rueda delantera
- 14- 96079 latiguillo freno delantero

SPACE-III desde '96 hasta '02 2.0 gasolina motores de 8 válvulas F3R y de 16 válvulas F4R  
1.9 diesel motor F9Q  
2.2 Diesel motores G8T('00) y G9T ('00-)

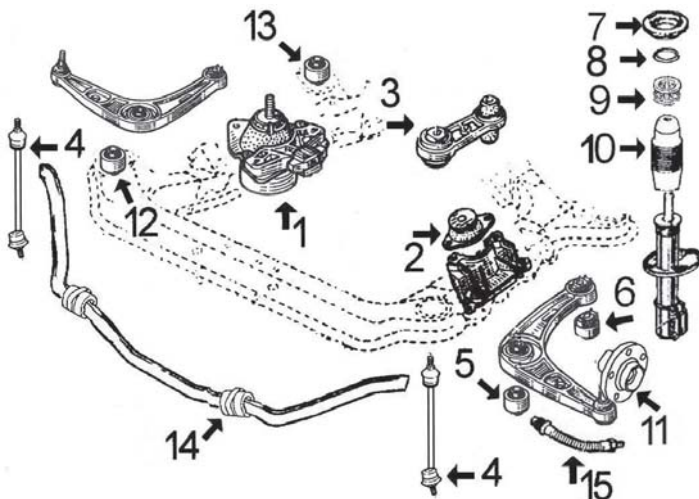

- 1- 4183 soporte motor derecho 2.0 gasolina motor 8v F3R
- 2897 soporte motor derecho 1.9D-F9Q y 2.2D-G8T/G9T
- 4087 soporte motor derecho 2.0 gasolina motor 16v F4R
- 2- 4091 soporte motor izquierdo 2.0 gasolina motor 8v F3R
- 4091 soporte motor izquierdo 2.0 gasolina motor 16v F4R
- 4091 soporte motor izquierdo 1.9D motor F9Q
- 2898 soporte motor izquierdo 2.2 diesel motor G8T-'00
- 4462 soporte motor izquierdo 2.2 diesel motor G9T-'00-
- 3- 4575 soporte motor trasero 2.0 gasolina F3R y F4R
- 4575 soporte motor trasero 1.9 Diesel-F9Q
- 4090 soporte motor trasero 2.2 diesel G8T-'00
- 4576 soporte motor trasero 2.2 diesel G8T-'00-
- 4- 4243 bieleta puntal barra estabilizadora
- 5- 2664 silentbloc anterior trapecio delantero
- 6- 2663 silentbloc posterior trapecio delantero
- 7- 4029 soporte amortiguador delantero derecho
- 4030 soporte amortiguador delantero izquierdo
- 8- 4178 rodamiento soporte amortiguador
- 9- n/d tope de goma amortiguador delantero
- 10- 4173 capuchón amortiguador
- 11- 90067 buje rueda delantera
- 12- 4607 silentbloc posterior sub-chasis delantero
- 13- 4606 silentbloc anterior sub-chasis delantero
- 14- 4578 goma barra estabilizadora delantera
- 15- 96079 latiguillo freno delantero



# RENAULT ESPACE - II - III - IV

ESPACE-IV desde '02

2.0 gasolina motor de 16 válvulas F4R  
 1.9 Diesel motor F9Q  
 2.2 Diesel motor G9T  
 3.0 gasolina motor V6

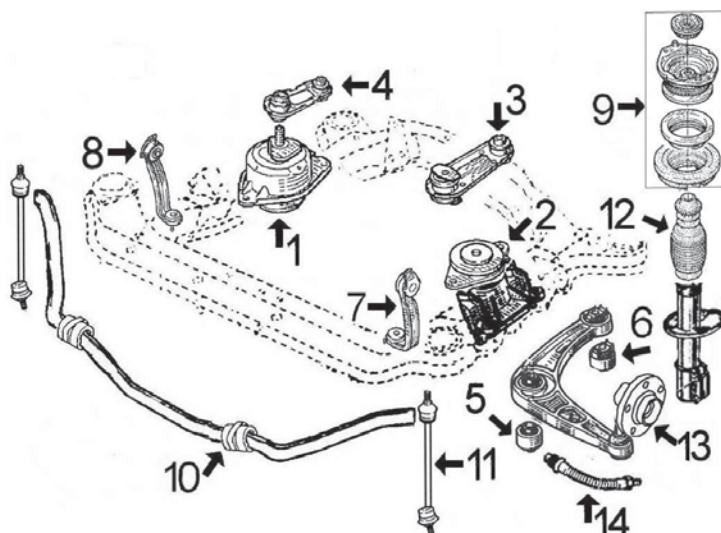

- 1- 4461 soporte motor derecho todos modelos
- 2- 4462 soporte motor izquierdo todos modelos
- 3- 4452 soporte motor trasero 2.0-16v F4R  
 4452 soporte motor trasero 1.9 Diesel-F9Q680  
 4452 soporte motor trasero 2.2 Diesel G9T  
 4452 soporte motor trasero 3.0 V6  
 4467 soporte motor trasero 1.9 Diesel-F9Q820  
 4467 soporte motor trasero cambio automático todos tipos
- 4- 4466 bieleta antipar en soporte derecho 1.9 Diesel  
 4466 bieleta antipar en soporte derecho 2.2 Diesel y 3.0 V6  
 4469 bieleta antipar en soporte derecho 2.0-16v F4R
- 4- 4243 bieleta puntal barra estabilizadora
- 5- 4487 silentbloc anterior trapecio delantero
- 6- 4488 silentbloc posterior trapecio delantero
- 7- 4587 soporte izquierdo sub-chasis delantero
- 8- 4588 soporte derecho sub-chasis delantero
- 9- 4572 soporte amortiguador delantero completo con rodamiento y accesorios
- 10- 4578 goma barra estabilizadora
- 11- 4457 bieleta puntal barra estabilizadora delantera
- 12- 4827 capuchón amortiguador delantero
- 13- n/d buje rueda delantera
- 14- n/d latiguillo freno delantero

## SUSPENSION TRASERA:

ESPACE-II desde '91 hasta '96  
 ESPACE-III desde '96 hasta '02

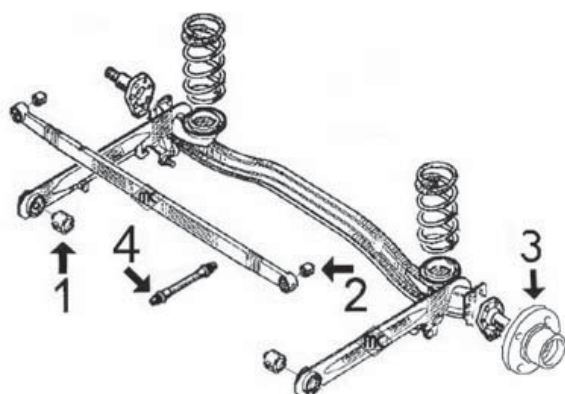

- 1- 4581 silentbloc soporte puente trasero
- 2- 4582 silentbloc barra Panhard Espace-II ('90-'96)  
 4579 silentbloc barra Panhard Espace-III ('96-'02)
- 3- 90527 buje rueda trasera completo con rodamiento
- 4- n/d latiguillo freno trasero

## RENAULT ESPACE - II - III - IV

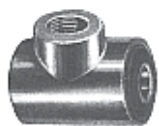

**211**  
silentbloc inferior amortiguador delantero  
r.o. 7701348300



**776**  
silentbloc anterior sub-chasis hasta '96  
r.o. 7700767684



**777**  
silentbloc posterior sub-chasis hasta '96  
r.o. 7700767786

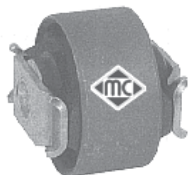

**2663**  
silentbloc posterior trapecio delantero  
desde '96, r.o. 7700824042-6025311529



**2664**  
silentbloc anterior trapecio delantero  
desde '96, r.o. 7700822503



**2897** **hidráulico**  
soporte motor derecho diesel desde '96  
r.o. 7700414099



**2898**  
soporte motor izquierdo diesel desde '96  
r.o. 7700818369



**4029**  
soporte amortiguador delantero derecho  
desde '96, r.o. 7700832420-6025305979

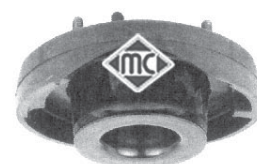

**4030**  
soporte amortiguador delantero izquierdo  
desde '96, r.o. 7700832419-6025305980



**4087**  
soporte motor derecho 2.0-16v  
r.o. 6025402944



**4090**  
soporte motor trasero diesel desde '96  
r.o. 7700411189



**4091**  
soporte motor izqdo. 2.0 gasolina d/'96  
r.o. 7700818372



**4119**  
soporte motor derecho desde '90 a '96  
r.o. 7700783016



**4120**  
soporte motor izquierdo desde '90 a '96  
r.o. 7700783018



**4171**  
soporte derecho cambio desde '90 a '96  
r.o. 7700768011

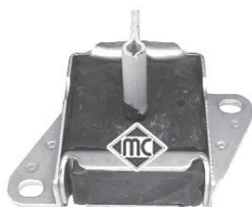

**4172**  
soporte izquierdo cambio desde '90 a '96  
r.o. 7700768010



**4173**  
capuchón amortiguador desde '96  
r.o. 7700776743



**4178**  
rodamiento soporte amortg. desde '96  
r.o. 7700803635

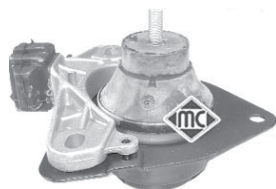

**4183**  
soporte motor dcho. 2.0 gasolina desde '96  
r.o. 7700823950























**4199**  
silentbloc anterior trapecio delantero des-  
de '90 a '96, r.o. 7700781463



**4217**  
silentbloc posterior trapecio delantero des-  
de '90 a '96, r.o. 7700781441

## RENAULT ESPACE - II - III - IV

 <p><b>4243</b> bieleta puntal barra estabiliz. Espace-III r.o. 7700805494</p>	 <p><b>4452</b> soporte motor trasero 1.9D-2.0-2.2D r.o. 8200259836</p>	 <p><b>4457</b> bieleta puntal barra estabiliz. Espace-IV r.o. 8200002870</p>
 <p><b>4461</b> soporte motor derecho Espace-IV r.o. 8200181590-8200052028</p>	 <p><b>4462</b> soporte motor izquierdo Espace-IV r.o. 8200357462</p>	 <p><b>4466</b> bieleta antipar Espace-IV 1.9D-2.2D-3.0V6 r.o. 8200250743</p>
 <p><b>4467</b> soporte motor trasero Espace-IV 1.9D y aut. r.o. 8200371093</p>	 <p><b>4469</b> bieleta antipar Espace-IV 2.0-16v r.o. 8200358666</p>	 <p><b>4487</b> silentbloc anterior trapecio delantero Espace-IV, r.o. 8200002868</p>
 <p><b>4488</b> silentbloc posterior trapecio delantero Espace-IV, r.o. 8200002869</p>	 <p><b>4572</b> soporte amortiguador delantero completo Espace-IV, r.o. 7701207350</p>	 <p><b>4573</b> goma barra estabilizadora Espace-II r.o. 7700797821</p>
 <p><b>4574</b> bieleta puntal barra estabilizadora Espace-II r.o. 7700781500</p>	 <p><b>4575</b> soporte motor trasero Espace-III 1.9D r.o. 6025304389</p>	 <p><b>4576</b> soporte motor trasero Espace-III 2.2D r.o. 6025403418</p>
 <p><b>4578</b> goma barra estabilizadora Espace-IV r.o. 8200272592</p>	 <p><b>4579</b> silentbloc barra Panhard Espace-III r.o. 6025006302</p>	 <p><b>4580</b> (10x38x43x58) silentbloc brazo superior espace-II r.o. 7704001734</p>
 <p><b>4581</b> silentbloc soporte puente trasero Esp-II y III r.o. 6025315757</p>	 <p><b>4582</b> (10x34x31x41) silentbloc barra Panhard Espace-II r.o. 6025000249</p>	 <p><b>4587</b> soporte izquierdo sub-chasis delantero Espace-IV, r.o. 8200000514</p>

## RENAULT ESPACE - II - III - IV

**¡Nuevo!**



**4588**  
soporte derecho sub-chasis delantero  
Espace-IV, r.o. 8200000515

**¡Nuevo!**



**4606**  
silentbloc anterior sub-chasis delantero  
Espace-III, r.o. 7700824709

**¡Nuevo!**



**4607**  
silentbloc posterior sub-chasis delantero  
Espace-III, r.o. 7700826216

**¡Nuevo!**



**4827**  
capuchón amortiguador delantero Espace-IV  
r.o. 8200180137

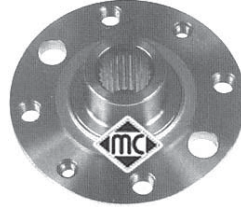

**90033**  
buje rueda delantera Espace-II  
r.o. 7700715149

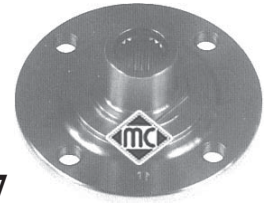

**90067**  
buje rueda delantera Espace-III  
r.o. 7700830220







**90527**  
buje rueda trasera completo con rodamiento  
Espace II y III, r.o. 7701204667



**96079**  
latiguillo freno delantero Espace-II / III  
(420mm), r.o. 7700845510



## RENAULT ESPACE - II - III - IV

<p><b>¡Nuevo!</b></p>  <p><b>4455</b> polea cigüeñal 1.9D Espace-III r.o. 7700115766</p>	<p><b>¡Nuevo!</b></p>  <p><b>4664</b> polea cigüeñal 1.9D Espace-III r.o. 7700856673</p>	 <p><b>4163</b> polea cigüeñal 1.9D Espace-III r.o. 7700115309</p>
<p><b>¡Nuevo!</b></p>  <p><b>4666</b> polea cigüeñal 1.9D Espace-IV r.o. 8200297937</p>	<p><b>¡Nuevo!</b></p>  <p><b>4734</b> polea cigüeñal 1.9D Espace-IV r.o. 8200457775</p>	<p><b>¡Nuevo!</b></p>  <p><b>4577</b> polea cigüeñal 2.0-8v (F3R) r.o. 7700109260</p>
<p><b>¡Nuevo!</b></p>  <p><b>4464</b> polea cigüeñal 2.0-16v (F4R) r.o. 8200276838</p>	<p><b>¡Nuevo!</b></p>  <p><b>4611</b> polea cigüeñal 2.0-16v (F4R) r.o. 8200297935</p>	 <p><b>2850</b> polea cigüeñal 2.1D motor J8S, hasta '91 r.o. 7700853470</p>
 <p><b>2851</b> polea cigüeñal 2.1D motor G8T hasta '97 r.o. 7700858731</p>	<p><b>¡Nuevo!</b></p>  <p><b>4489</b> polea cigüeñal 2.1D motor G8T desde '97 r.o. 7700104292</p>	<p><b>¡Nuevo!</b></p>  <p><b>4463</b> polea cigüeñal 2.2D Espace-IV (G9T) r.o. 8200213058</p>
<p><b>¡Nuevo!</b></p>  <p><b>4585</b> polea cigüeñal 2.2D Espace-IV (G9T) r.o. 8200207435</p>	<p><b>¡Nuevo!</b></p>  <p><b>4994</b> polea árbol de levas 1.9DTi-DCi (F9Q) r.o. 7700866844-7700107401</p>	<p><b>¡Nuevo!</b></p>  <p><b>4728</b> <b>sólida</b> polea alternador 5 canales r.o.</p>
<p><b>¡Nuevo!</b></p>  <p><b>4729</b> <b>sólida</b> polea alternador 6 canales r.o.</p>	<p><b>¡Nuevo!</b></p>  <p><b>4947</b> <b>desembragable</b> polea alternador 5 canales r.o. 8200113636</p>	<p><b>¡Nuevo!</b></p>  <p><b>4948</b> <b>desembragable</b> polea alternador 6 canales r.o. 7700110616</p>
<p><b>¡Nuevo!</b></p>  <p><b>4912</b> <b>Ø 61,00 mm</b> polea de alternador de rueda libre r.o.</p>	<p><b>¡Nuevo!</b></p>  <p><b>4913</b> <b>Ø 53,30 mm</b> polea de alternador de rueda libre r.o.</p>	<p><b>¡Nuevo!</b></p>  <p><b>4914</b> <b>Ø 55,40 mm</b> polea de alternador de rueda libre r.o.</p>

## RENAULT ESPACE - II - III - IV



**907**  
juego casquillos levas cambio hasta '96  
Espace-II, r.o. 7700689713+7700692252



**908**  
juego casquillos retén palanca selector  
Espace-II-III, r.o. 7700679960-7703087163



**2883**  
bieleta selector de velocidades completa  
Espace-II-III, r.o. 7700875584+7700872205

**¡Nuevo!**



**4724**  
varilla nivel aceite 2.2 Diesel  
r.o. 8200086256

**¡Nuevo!**



**4725**  
varilla nivel aceite 1.9 Diesel  
r.o. 8200138515



**3617**  
tapón llenado aceite 1.9 Diesel desde '99  
r.o. 7700110720

**¡Nuevo!**



**3648**  
tapón llenado aceite 2.2 Diesel G8T-G9T  
r.o. 7700870192

**¡Nuevo!**



**4641**  
jgo tapas árboles de levas 2.0/16v  
r.o. 7700106271+7700274026

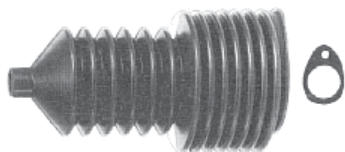

**1561**  
fuelle cremallera asistida Espace-I-II  
r.o. 7700706007

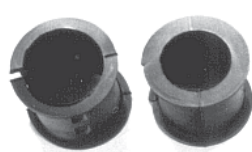

**2316**  
jgo gomas sujeción cremallera asistida  
r.o. 7700778304+7700662571



**1355**  
fuelle cremallera dirección asist. Espace-III  
y IV, r.o. 7701469657



**1343**  
kit fuelle transmisión l/rueda Espace-I 2.0  
Espace-II, r.o.

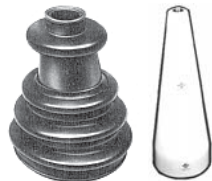

**1273E** se puede montar con cono  
kit fuelle transmisión l/rueda 2.1 Diesel  
Espace-I, r.o. 7701457539



**1732-E** se puede montar con cono  
kit fuelle transmisión l/rueda Espace-II  
(homocinética de Ø82 mm) r.o. 7701035088



**1517**  
kit fuelle transmisión l/rueda (homocinética  
de Ø90 mm) Espace-II-III-IV, r.o. 7701469021



**1523**  
kit fuelle transmisión derecha l/cambio  
r.o. 7701466349

**¡Nuevo!**



**1135**  
kit fuelle transmisión derecha l/cambio  
r.o. 7701470910



**2304**  
con rodamiento Ø 28,0 mm  
kit fuelle transmisión izquierda l/cambio  
(Ø exterior boca grande 114 mm)

**¡Nuevo!**



**1139**  
con rodamiento Ø 28,0 mm  
kit fuelle transmisión izquierda l/cambio  
(Ø exterior boca grande 105 mm)

## RENAULT ESPACE - II - III - IV

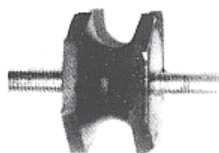

**240**  
soporte tubo de escape Espace-I-II  
r.o. 7700565762



**262**  
soporte tubo de escape Espace-I-II  
r.o. 7700655644

**¡nuevo!**



**280**  
soporte tubo de escape Espace-I-II  
r.o. 7700685267



**2382**      **Ø 90 x 73 mm**  
junta cónica tubo de escape  
r.o. 7700766353



**4218**  
soporte tubo de escape Espace-III  
r.o.



**4586**  
soporte tubo de escape Espace-IV  
r.o. 8200047018

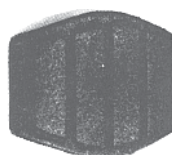

**417**  
cubrepedal freno y embrague Espace-I-II-III  
r.o. 7700832177

**¡nuevo!**



**4717**  
cubrepedal freno y embrague espace-IV  
r.o. 8200183752



**670**  
tapón cárter de aceite 16x150  
r.o. 7903075033



**668**  
tapón cárter de aceite Espace-I, 18x150  
r.o.

**¡nuevo!**



**4709**  
soporte filtro de aire (largo)  
r.o. 7700744145



**153**  
soporte filtro de aire (corto)  
r.o. 7704002509

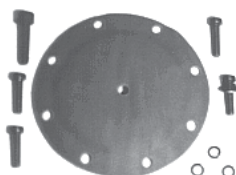

**832**  
jgo reparación membrana depresor Diesel  
Espace-I-II, r.o.



# RENAULT EXPRESS

## CANALIZACIONES DE AGUA. Modelos representados:

### EXPRESS 1.1 y 1.4 gasolina hasta modelo '91:

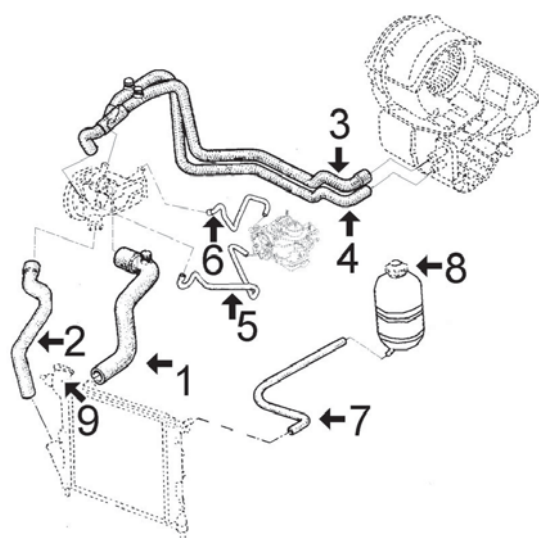

modelos F401 y F402 respectivamente, motores C1E de 1108cc y C1J de 1397 cc

- 1- 7512 mgto superior de radiador (con purgador)
- 2- 7668 mgto inferior de radiador
- 3- 7677 mgto de calefactor a bomba (con purgador)
- 4- 7794 mgto de calefactor a bomba (con purgador)
- 5- 7672 mgto de bomba de agua a carburador
- 6- 7671 mgto de bomba de agua a carburador
- 7- 760 mgto sobrante de botella a radiador. Cortar de rollo ref. MC-760, Ø 6x10 mm
- 8- 3501 botella de expansión
- 3519 tapón de botella 0,7 bar
- 3524 tapón de botella 1,0 bar
- 3514 tapón de botella 1,20 bar
- 9- 3692 tapón de radiador (metálico)



- 7669 mgto desvaporizador
- 7670 mgto desvaporizador

### EXPRESS 1.6 Diesel hasta modelo '91:

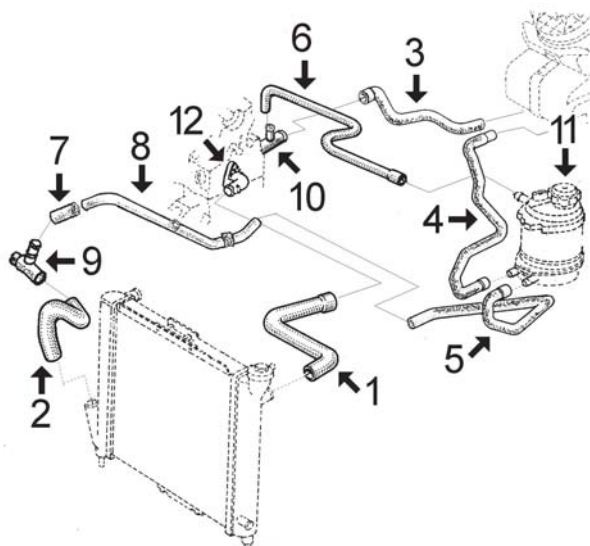

modelo F404, motor F8M de 1596 cc

- 1- 7508 mgto superior de radiador
- 2- 7509 mgto inferior de radiador
- 3- 7664 mgto de calefactor a boquilla en culata
- 4- 7974 mgto de calefactor a botella
- 5- 7975 mgto de botella a tubo metálico
- 6- 8059 mgto de sobrante botella a boquilla en culata
- 7- 8098 mgto de boquilla 3 vias a tubo metálico
- 8- 3031 tubo de agua metálico
- 9- 3000 boquilla 3 vias entrada agua a bloque
- 10- 3029 boquilla 3 vias clavada en culata
- 11- 3501 botella de expansión
- 3519 tapón de botella 0,7 bar
- 3524 tapón de botella 1,0 bar
- 3514 tapón de botella 1,20 bar
- 12- 3117 tapa de termostato



- 8148 mgto desvaporizador

### EXPRESS 1.1 y 1.2 gasolina desde modelo '91:

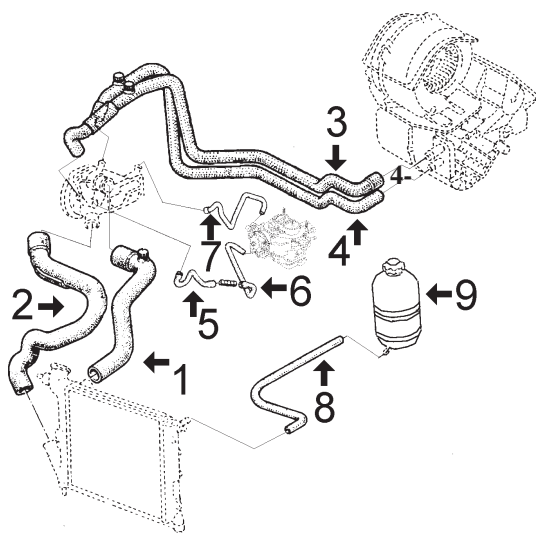

modelos F40T / F401 y F40F, motores C1E de 1108 cc y C1G de 1237 cc

- 1- 7842 mgto superior de radiador (con purgador)
- 2- 7843 mgto inferior de radiador
- 3- 7677 mgto de bomba a calefactor (con purgador)
- 7794 mgto de bomba a calefactor (con purgador)
- 5- 7969 mgto de bomba a carburador (1er. tramo)
- 6- 7970 mgto de bomba a carburador (2º tramo)
- 7- 7671 mgto de bomba a carburador
- 8- 760 mgto sobrante de botella a radiador: Cortar de rollo ref. MC-760, Ø 6x10 mm
- 9- 3501 botella de expansión
- 3519 tapón de botella 0,70 bar
- 3524 tapón de botella 1,00 bar
- 3514 tapón de botella 1,20 bar



- 7669 mgto desvaporizador
- 7670 mgto desvaporizador



# RENAULT EXPRESS

## EXPRESS 1.4 gasolina desde modelo '91:

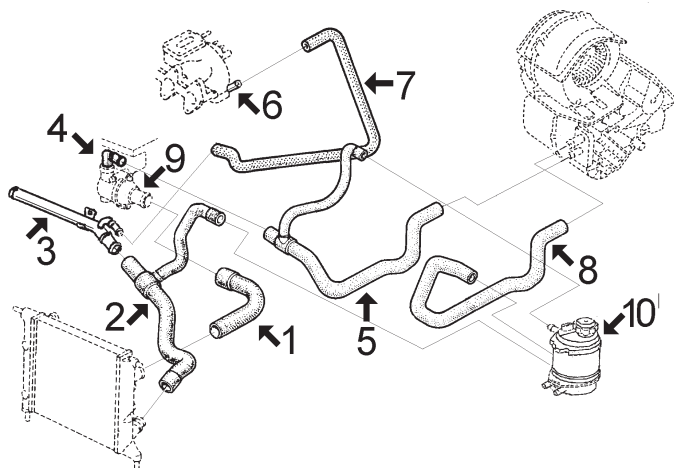

modelos F40A y F40Y, motores E6J de 1390 cc de carburador y E7J de 1390 cc de inyección

- 1- 7844 mgtto superior radiador sin aire acondicionado
- 7955 mgtto superior radiador con aire acondicionado
- 2- 8132 mgtto inferior radiador sin aire acondicionado
- n/d mgtto inferior radiador con aire acondicionado
- 3- 3028 tubo de agua metálico
- 4- 3173 caja de termostato
- 5- 8134 mgtto de calefactor a boquilla de termostato
- 6- 3010 boquilla metálica en colector de admisión
- 7- 7907 mgtto de tubo metálico a boquilla en colector
- 8- 8130 mgtto de calefactor a botella
- 9- 3116 tapa de termostato
- 10- 3500 botella de expansión
- 3519 tapón de botella 0,70 bar
- 3524 tapón de botella 1,00 bar
- 3514 tapón de botella 1,20 bar

## EXPRESS 1.6 Diesel desde '91

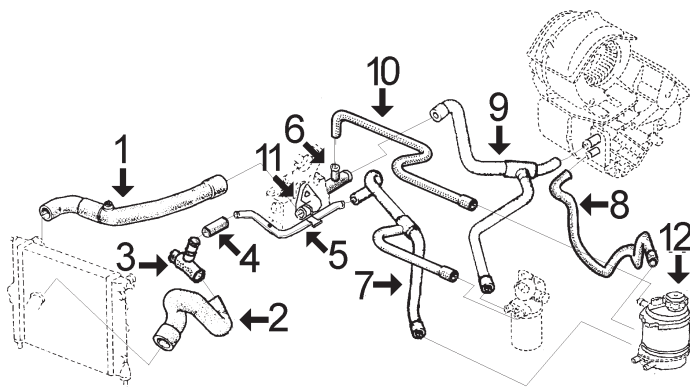

modelo F404. motor F8M de 1596 cc

- 1- 7846 mgtto superior de radiador
- 2- 8076 mgtto inferior de radiador
- 3- 3000 boquilla 3 vias entrada agua a bloque motor
- 4- 8098 mgtto de boquilla 3 vias a tubo metálico
- 5- 3031 tubo de agua metálico hasta '93
- 3121 tubo de agua metálico desde '93
- 6- 3029 boquilla 3 vias clavada en culata
- 7- 8176 mgtto 3 vias de botella a tubo metálico y a filtro de gasoil
- 8- 8130 mgtto de calefactor a botella
- 9- 8169 mgtto 3 vias de calefactor a boquilla clavada en culata y a filtro de gasoil
- 10- 8688 mgtto sobrante de botella a boquilla en culata
- 11- 3117 tapa de termostato
- 2362 junta de termostato
- 12- 3500 botella de expansión
- 3519 tapón de botella 0,70 bar
- 3524 tapón de botella 1,00 bar
- 3514 tapón de botella 1,20 bar



8148 mgtto desvaporizador

## EXPRESS 1.9 Diesel hasta 10/'95, versiones con intercambiador en el filtro de gasoil e intercambiador en el filtro de aceite.

modelos F40N y F40P motor F8Q de 1870 cc

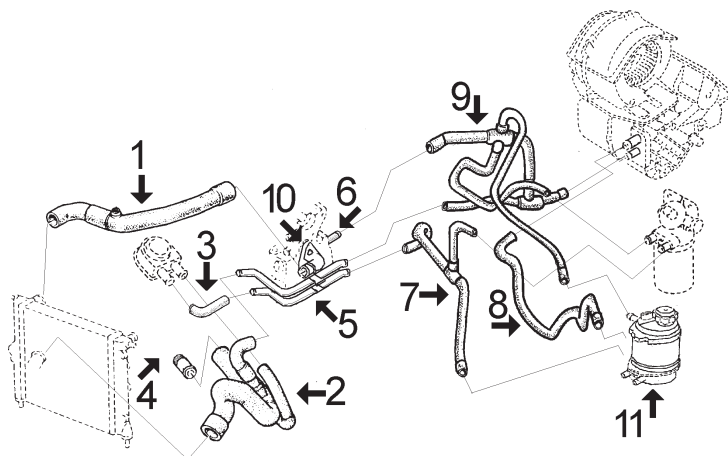

- 1- 7846 mgtto superior de radiador
- 2- 7847 mgtto inferior de radiador 4 vias hasta '95
- 8076 mgtto inferior radiador desde '95
- 3- 8170 mgtto de intercambiador a tubo metálico
- 4- 3055 boquilla entrada agua a bloque motor hasta '97
- 3665 boquilla entrada agua a bloque motor desde '97
- 5- 3058 tubo de agua metálico hasta '95
- 3125 tubo de agua metálico desde '95
- 6- 3033 boquilla clavada en culata
- 7- 8176 mgtto de botella a tubo y a filtro de gasoil (\*)
- 8- 8130 mgtto de calefactor a botella
- 9- 8435 mgtto 4 vias de calefactor a boquilla en culata y a botella y filtro de gasoil (\*)
- 10- 3117 tapa de termostato
- 2362 junta de termostato
- 11- 3500 botella de expansión
- 3524 tapón de botella 1,0 bar
- 3514 tapón de botella 1,20 bar

(\*) se suministra con tapón de goma para cubrir la derivación hacia el filtro de gasoil para los modelos no equipados con intercambiador.

## RENAULT EXPRESS

### EXPRESS 1.9 Diesel desde 10/'95, versión sin intercambiador en el filtro de gasoil: (modelos con tubo de agua metálico doble)

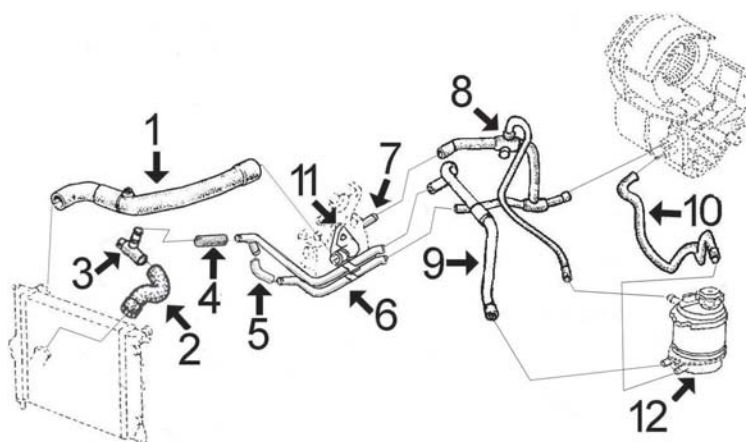

- 1- 7846 mgto superior de radiador
- 2- 8076 mgto inferior de radiador
- 3- 3000 boquilla entrada agua a bloque h/ '97 (metal)
- 3665 boquilla entrada agua a bloque d/ '97 (plástico)
- 4- 8098 mgto de boquilla 3 vias a tubo metálico
- 5- 0119 mgto enlace boquillas tubo metálico, cortar de rollo MC-119 Ø 16x22 mm, long. 130 mm
- 6- 3125 tubo de agua metálico
- 7- 3033 boquilla metálica clavada en culata
- 8- 8435 mgto multivia de calefactor a culata, tubo metálico y botella
- 9- 8176 mgto de botella a tubo metálico
- 10- 8130 mgto de calefactor a botella
- 11- 3117 tapa de termostato
- 2362 junta de termostato
- 12- 3500 botella de expansión
- 3525 tapón de botella 1,40 bar



- ~~8665 mgto desvaporizador~~
- ~~8666 mgto desvaporizador~~
- ~~8751 mgto desvaporizador~~

### EXPRESS 1.9 Diesel desde 10/'95 sin intercambiador en el filtro de gasoil: (modelos con tubo de agua metálico simple)

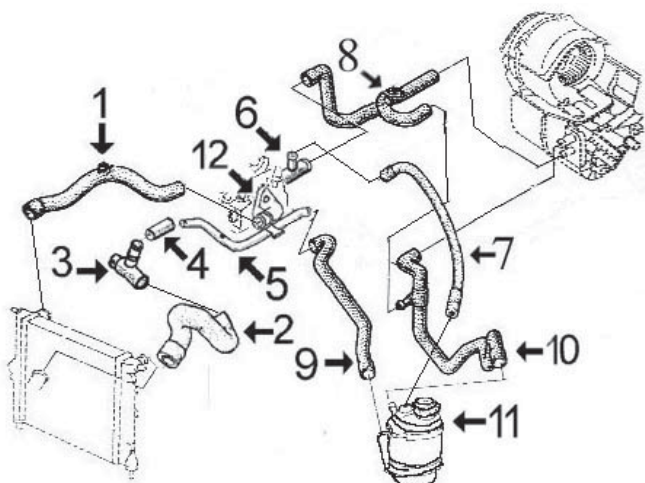

- 1- 7846 mgto superior de radiador
- 2- 8076 mgto inferior de radiador
- 3- 3665 boquilla entrada agua a bloque
- 4- 8098 mgto de boquilla 3 vias a tubo metálico
- 5- 3143 tubo de agua metálico
- 6- 3029 boquilla metálica clavada en culata
- 7- 8688 mgto de botella a boquilla en culata
- 8- 8691 mgto de calefactor a culata
- 9- 8689 mgto de botella a tubo metálico
- 10- 8692 mgto de calefactor a botella
- 11- 3500 botella de expansión
- 3525 tapón de botella 1,40 bar
- 12- 3117 tapa de termostato
- 2362 junta de termostato



- ~~8665 mgto desvaporizador~~
- ~~8666 mgto desvaporizador~~
- ~~8751 mgto desvaporizador~~

### EXPRESS 1.9 Diesel desde 10/'95 con intercambiador en el filtro de gasoil

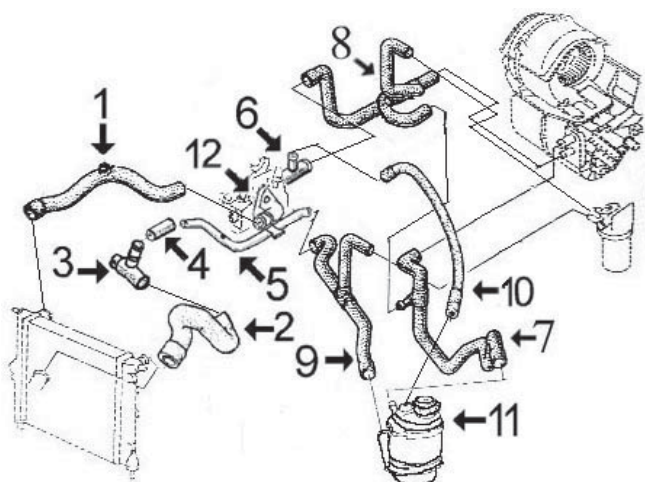

- 1- 7846 mgto superior de radiador
- 2- 8076 mgto inferior de radiador
- 3- 3665 boquilla entrada agua a bloque
- 4- 8098 mgto de boquilla 3 vias a tubo metálico
- 5- 3143 tubo de agua metálico
- 6- 3029 boquilla metálica clavada en culata
- 7- 8692 mgto de calefactor a botella
- 8- 8690 mgto de calefactor a culata y filtro de gasoil
- 9- 8176 mgto de botella a tubo metálico y filtro de gasoil
- 10- 8688 mgto de botella a boquilla en culata
- 11- 3500 botella de expansión
- 3525 tapón de botella 1,40 bar
- 12- 3117 tapa de termostato
- 2362 junta de termostato



- ~~8665 mgto desvaporizador~~
- ~~8666 mgto desvaporizador~~
- ~~8751 mgto desvaporizador~~

# RENAULT EXPRESS



**7508**  
mgto superior radiador 1.6D hasta '91  
r.o. 7700751785



**7509**  
mgto inferior radiador 1.6D hasta '91  
r.o. 7700751786

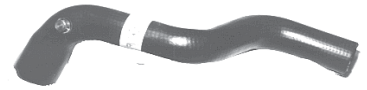

**7512**  
mgto superior radiador 1.1/1.4 hasta '91  
r.o. 7700762342



**7664**  
mgto de calefactor a culata 1.6D hasta '91  
r.o. 770073179



**7668**  
mgto inferior radiador 1.1-1.4 hasta '91  
r.o. 7700781076



**7669**  
mgto desvaporizador 1.1-1.2-1.4  
r.o. 7700678777



**7670**  
mgto desvaporizador 1.1-1.2-1.4  
r.o. 7700678778



**7671**  
mgto de bomba a carburador 1.1-1.2-1.4  
r.o. 7700726561



**7672**  
mgto de bomba a carburador 1.1-1.4  
r.o. 7700706840



**7677**  
mgto calefactor 1.1-1.2-1.4  
r.o. 7700762034



**7794**  
mgto calefactor 1.1-1.2-1.4  
r.o. 7700762033



**7842**  
mgto superior radiador 1.1-1.2 desde '91  
r.o. 7700801058



**7843**  
mgto inferior radiador 1.1-1.2 desde '91  
r.o. 7700801059



**7844**  
mgto sup radiador 1.4 desde '91 sin aire ac.  
r.o. 7700801054



**7846**  
mgto superior radiador Diesel desde '91  
r.o. 7700824034



**7847**  
mgto inferior radiador 1.9 Diesel hasta '95  
r.o. 7700801067



**7907**  
mgto de tubo metálico a colector 1.4 d/'91  
r.o. 7700741327



**7955**  
mgto sup radiador 1.4 desde '91 aire ac.  
r.o. 7700801061



**7969**  
mgto de bomba a carburador 1.1-1.2 d/'91  
r.o. 7700739814























**7970**  
mgto de bomba a carburador 1.1-1.2 '91  
r.o. 7700739813



**7974**  
mgto de calefactor a botella 1.6D hasta '91  
r.o. 7700214740



## RENAULT EXPRESS

 <p><b>7975</b> mgto de botella a tubo 1.6D hasta '91 r.o. 7700781397</p>	 <p><b>8059</b> mgto de botella a culata 1.6D hasta '91 r.o. 7700757244</p>	 <p><b>8076</b> mgto inferior radiador 1.6D desde '91 r.o. 60060001231</p>
 <p><b>8098</b> mgto de boquilla a tubo 1.6D-1.9D r.o. 7700742500</p>	 <p><b>8130</b> mgto de calefactor a botella Diesel d/'91 r.o. 6006000653</p>	 <p><b>8132</b> mgto inferior radiador 1.4 desde '91 sin aire acondicionado, r.o. 6006000736</p>
 <p><b>8134</b> mgto de calefactor a termostato 1.4 d/'91 r.o. 6006000656</p>	 <p><b>8148</b> mgto desvaporizador 1.6 Diesel r.o. 7700714556</p>	 <p><b>8169</b> mgto de calefactor a culata 1.6D desde '91 r.o. 6006000781</p>
 <p><b>8170</b> mgto de intercambiador a tubo 1.9 D r.o. 7700749885</p>	 <p><b>8176</b> mgto de botella a tubo Diesel desde '91 r.o. 6006000793</p>	 <p><b>8435</b> mgto de calefactor a culata, filtro de gasoil, y botella, r.o. 6006000698</p>
 <p><b>8665</b> mgto desvaporizador 1.9 Diesel r.o.</p>	 <p><b>8666</b> mgto desvaporizador 1.9 Diesel r.o. 700862370</p>	 <p><b>8688</b> mgto de botella a tubo metálico 1.9 D r.o. 6006000699</p>
 <p><b>8689</b> mgto de botella a tubo metálico 1.9 D r.o. 7700302579</p>	 <p><b>8690</b> mgto de calefactor a culata 1.9 Diesel r.o. 7700306358</p>	 <p><b>8691</b> mgto de calefactor a culata 1.9 Diesel r.o. 7700308595</p>
 <p><b>8692</b> mgto de calefactor a botella 1.9 D r.o. 7700306359</p>	 <p><b>8751</b> mgto desvaporizador 1.9 Diesel r.o. 7700869572</p>	 <p><b>3000</b> boquilla entrada agua a bloque 1.6 Diesel r.o. 7700860063</p>



## RENAULT EXPRESS



**3010** Ø 16 mm  
boquilla en colector 1.4 desde '91  
r.o. 7705030338



**3028**  
tubo de agua metálico 1.4 desde '91  
r.o. 7700859465



**3029**  
boquilla en culata 1.6-1.9 Diesel  
r.o. 7700860882



**3031**  
tubo de agua metálico 1.6 Diesel hasta '95  
r.o. 7700860517



**3033** Ø 20 mm  
boquilla en culata 1.9 Diesel  
r.o. 7705030135



**3055**  
boquilla entrada agua a bloque 1.9 Diesel  
r.o. 7700860825



**3058**  
tubo de agua metálico 1.9 Diesel hasta '95  
r.o. 7700864993



**3121**  
tubo de agua metálico 1.6D-1.9D d/'93  
sin intercamb filtro aceite, r.o. 7700862234



**3125**  
tubo de agua metálico 1.9D desde '95  
r.o. 7700873509-7700873508



**3143**  
tubo de agua metálico 1.9 Diesel F40R  
(agujero para sensor abierto, M-12) r.o.



**3173**  
caja de termostato 1.4 desde '91  
r.o. 7700272358



**3665**  
boquilla entrada agua a bloque 1.9 Diesel  
desde '97, r.o. 7700101034



**3500**  
botella de expansión 1.2-1.4 y Diesel  
r.o. 7701203218



**3501**  
botella de expansión 1.1-1.2 hasta '91  
r.o. 7701203249



**3519** 0,70 bar-blanco  
tapón de botella de expansión  
r.o.



**3514** 1,20 bar-marrón  
tapón de botella de expansión  
r.o. 7700805031



**3525** 1,40 bar-celeste  
tapón de botella de expansión  
r.o. 7700805032



**3692**  
tapón de radiador 1.1-1.4 h/'91 (metálico)  
r.o. 7701018380



**3116**  
tapa de termostato 1.4 desde '91  
r.o. 7700738110



**3117**  
tapa de termostato 1.6D y 1.9D  
r.o. 7700851979



**3714**  
decantador completo 1.9 Diesel  
r.o.

# RENAULT EXPRESS

## SUSPENSION DELANTERA y SOPORTES DE MOTOR:

EXPRESS 1.1 - 1.4 hasta '91:

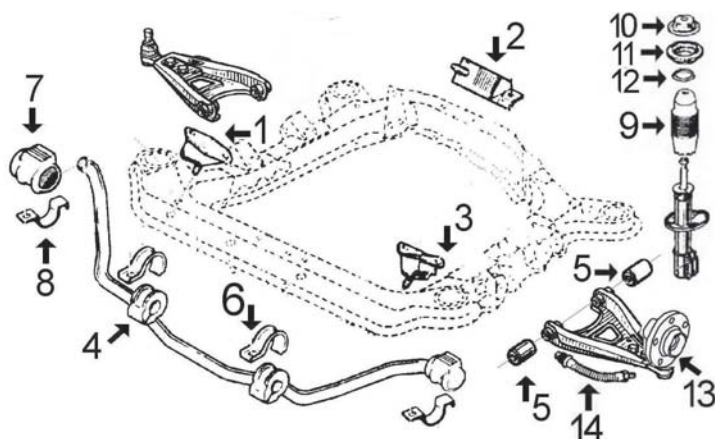

- |     |       |  |
|-----|-------|--|
| 1-  | 387   | soporte de motor delantero derecho           |
| 2-  | 389   | soporte de motor trasero                     |
| 3-  | 388   | soporte de motor delantero izquierdo         |
| 4-  | 469   | goma central barra estabilizadora            |
| 5-  | 360   | silentbloc trapecio inferior                 |
| 6-  | 828   | abrazadera goma central barra estabilizadora |
| 7-  | 466   | goma puntal barra estabilizadora (Ø 22 mm)   |
|     | 468   | goma puntal barra estabilizadora (Ø 21 mm)   |
| 8-  | 827   | abrazadera goma puntal barra estabilizadora  |
| 9-  | 4152  | capuchón con tope de goma                    |
| 10- | 4148  | tapa superior amortiguador                   |
| 11- | 4147  | goma apoyo amortiguador delantero            |
| 12- | 4178  | rodamiento superior amortiguador             |
| 13- | 90015 | buje rueda delantera                         |
| 14- | 96078 | latiguillo freno delantero (333 mm)          |

EXPRESS 1.6 Diesel:

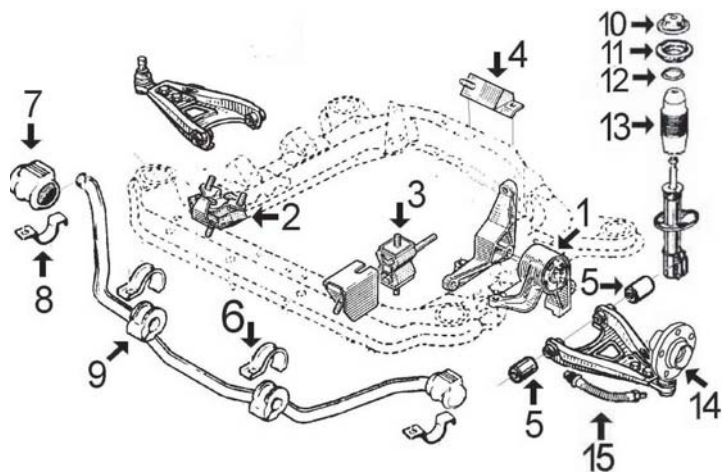

- |     |       |  |
|-----|-------|--|
| 1-  | 504   | soporte motor lateral izquierdo              |
| 2-  | 508   | soporte motor delantero derecho              |
| 3-  | 506   | soporte motor delantero izquierdo            |
| 4-  | 389   | soporte motor trasero                        |
| 5-  | 360   | silentbloc trapecio inferior                 |
| 6-  | 828   | abrazadera goma central barra estabilizadora |
| 7-  | 466   | goma puntal barra estabilizadora (Ø 22 mm)   |
| 8-  | 827   | abrazadera goma puntal barra estabilizadora  |
| 9-  | 469   | goma central barra estabilizadora            |
| 10- | 4148  | tapa superior amortiguador                   |
| 11- | 4147  | goma apoyo amortiguador delantero            |
| 12- | 4178  | rodamiento superior amortiguador             |
| 13- | 4152  | capuchón con tope de goma                    |
| 14- | 90015 | buje rueda delantera                         |
| 15- | 96078 | latiguillo freno delantero (333 mm)          |

# RENAULT EXPRESS

## EXPRESS 1.1 - 1.2 gasolina desde modelo '91:

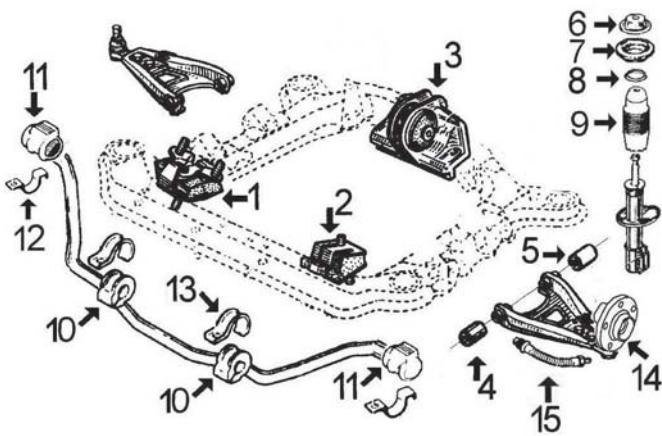

- 1- 2953 soporte de motor delantero derecho
- 2- 4155 soporte de motor delantero izquierdo
- 3- 707 soporte de motor trasero
- 4- 360 silentbloc trapecio inferior
- 5- 360 silentbloc trapecio inferior
- 6- 4148 tapa superior amortiguador
- 7- 787 goma apoyo amortiguador delantero
- 8- 4178 rodamiento superior amortiguador
- 9- 4152 capuchón con tope de goma
- 10- 469 goma central barra estabilizadora
- 11- 468 goma puntal barra estabilizadora (Ø 21 mm)
- 12- 827 abrazadera goma puntal barra estabilizadora
- 13- 828 abrazadera goma central barra estabilizadora
- 14- 90015 buje rueda delantera
- 15- 96078 latiguillo freno delantero (330 mm)

## EXPRESS 1.4 gasolina desde '91 1.9 Diesel

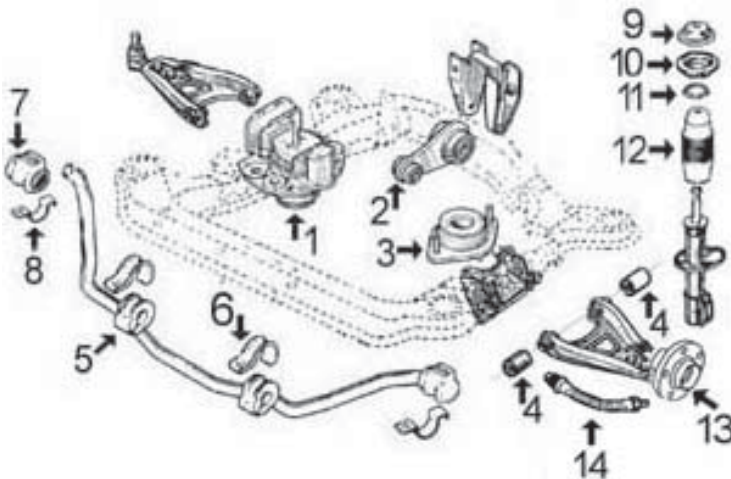

- 1- 997 soporte motor derecho gasolina
- 4086 soporte motor derecho Diesel
- 2- 972 bieleta soporte de motor trasero
- 3- 985 soporte de motor izquierdo
- 4- 360 silentbloc trapecio inferior
- 5- 469 goma central barra estabilizadora
- 6- 828 abrazadera goma central barra estabilizadora
- 7- 466 goma puntal barra estabilizadora (Ø 22 mm)
- 8- 827 abrazadera goma puntal barra estabilizadora
- 9- 4148 tapa cierre amortiguador
- 10- 787 goma apoyo amortiguador
- 11- 4178 rodamiento superior amortiguador
- 12- 4152 capuchón con tope de goma amortiguador
- 13- 90015 buje rueda delantera
- 14- 96078 latiguillo freno delantero (330 mm)

## SUSPENSION TRASERA

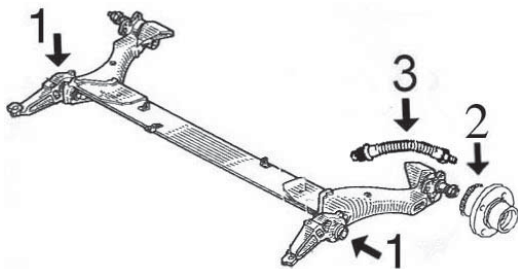

- 1- 784 silentbloc interior soporte puente trasero
- 2331 silentbloc exterior soporte puente trasero
- 2- 90527 buje rueda trasera con rodamiento
- 3- 96065 latiguillo freno trasero (305 mm)

## RENAULT EXPRESS



**387**  
soporte motor derecho 1.1/1.4 hasta '91  
r.o. 7704001318



**388**  
soporte motor izquierdo 1.1/1.4 hasta '91  
r.o. 7704001320

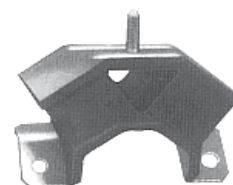

**389**  
soporte motor trasero 1.1/1.4 hasta '91 y  
1.6D todas, r.o. 7704001319

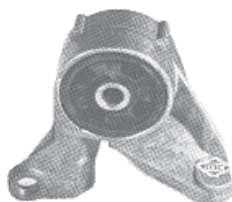

**504**  
soporte motor lateral izquierdo 1.6 Diesel  
r.o. 7700770479

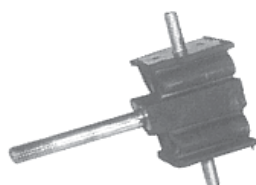

**506**  
soporte motor delantero izqdo. 1.6 Diesel  
r.o. 7700770307



**508**  
soporte motor delant. derecho 1.6 Diesel  
r.o. 7700770480



**707**  
soporte de motor trasero 1.1/1.2 desde '91  
r.o. 7700804163

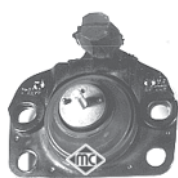

**997**      **hidráulico: peso 1.430 g**  
soporte motor derecho 1.4 desde '91  
r.o. 7700805123



**972**  
soporte motor trasero 1.4 y 1.9 D desde '91  
r.o. 7700841151



**985**  
soporte motor izquierdo 1.4 y 1.9 D d/'91  
r.o. 7700795689



**360**  
silentbloc trapecio inferior delantero  
r.o. 7704000681 (12x32x46x36)



**466**  
goma puntal barra estabilizadora Ø 22 mm  
r.o. 7700760264



**468**  
goma puntal barra estabilizad. Ø 21 mm  
r.o. 7700760265



**469**  
goma central barra estabilizadora  
r.o. 7702144561



**784**  
silentbloc brazo suspensión trasera  
r.o. no hay despiece (43x72x28x28)



**827**  
abrazadera puntal barra estabilizadora  
r.o. 7700680098



**828**  
abrazadera goma central barra estabiliz.  
r.o. 7700789817



**2331**  
silentbloc brazo suspensión trasera  
r.o. no hay despiece (43x72x36x36)

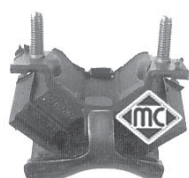

**2953**  
soporte motor derecho 1.1-1.2 desde '91  
r.o. 7700795687

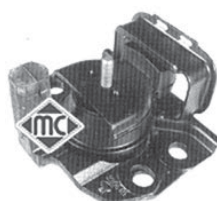

**4086**  
soporte motor derecho 1.9 Diesel  
r.o. 7700818994



**4147**  
goma apoyo amortiguador delantero  
r.o. 7700757324







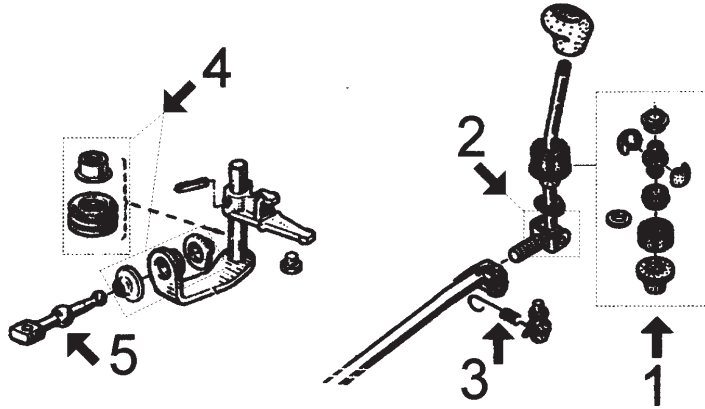

## RENAULT EXPRESS

 <b>4148</b> tapa superior amortiguador delantero r.o. 7700308789	 <b>4152</b> fuelle con tope de goma amortg. delantero r.o. 7700757323	 <b>4155</b> soporte motor izquierdo 1.1-1.2 desde '91 r.o. 7700795688
 <b>4178</b> rodamiento superior amortiguador delantero r.o. 7700797666-7700777654	 <b>90015</b> buje rueda delantera r.o. 7700719140	 <b>90527</b> buje rueda trasera con rodamiento r.o. 7701204692
 <b>96078</b> latiguillo freno delantero (333 mm) r.o. 7704003913	 <b>96065</b> latiguillo freno trasero (305 mm) r.o. 7704003905	

### C-ARTICULACIONES PALANCA DE CAMBIO todos modelos:



- 1- 516 juego casquillos palanca cambio
- 2- 2797 juego casquillos y eje pasador inferior palanca
- 3- 2372 juego completo muelle de retorno
- 4- 908 juego caquillos bieleta selector
- 5- 2883 bieleta selector

 <b>516</b> juego casquillos palanca de cambio r.o. 7700464111	 <b>908</b> juego casquillos bieleta selector velocidades r.o. 7703087115+7700679960+7700703000	 <b>2372</b> juego muelle retorno palanca cambio r.o. 7701468199
 <b>2797</b> juego casquillos y eje pasador palanca de cambio, r.o. no hay despiece	 <b>2883</b> bieleta selector de velocidades completa r.o. 7700875584+7700722910+7700722911	 <b>4297</b> horquilla embrague completa r.o. 7700725720

## RENAULT EXPRESS



**2849**  
polea cigüeñal Diesel **6 canales**  
r.o. 7700112999 (7700724249)



**350** fuelle **1350** kit  
kit reparación cremallera manual  
r.o.



**444**  
casquillo cremallera dirección manual  
r.o. 7704000926



**1561**  
fuelle cremallera asistida  
r.o. 7700781095



**1561-C**  
kit fuelles cremallera asistida completo  
r.o.

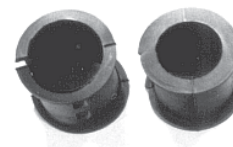

**2316**  
juego gomas sujeción cremallera asistida  
r.o. 7700778304+7700662571



**352**  
nuez articulación barra dirección 1.6 D todas  
y 1.1/1.4 hasta '91 r.o. 7700687433



**1274-E**  
kit rep. transm. l/rda **para montar en cono**  
(en neopreno especial de elasticidad 800%)



**1274** kit **274** fuelle  
kit reparación transmisión lado rueda  
(caña ancha), r.o. 7701348568



**1273-E**  
kit rep. transm. l/rda **para montar en cono**  
(en neopreno especial de elasticidad 800%)



**1273** kit **273** fuelle  
kit reparación transmisión lado rueda  
(caña estrecha), r.o. 7701465489



**1696-E**  
kit rep. transm l/rda **para montar en cono**  
I.1, r.o. 7701464551



**1517**  
kit reparación transmisión l/rda desde '92  
r.o. 7701035380



**1537** rodamiento de Ø 25.8 mm  
kit reparación transmisión corta l/cambio  
completo con rodamiento, r.o. 7701462100



**1562** rodamiento de Ø 22.8 mm  
kit reparación transmisión corta l/cambio  
completo con rodamiento r.o. 7701464129



**1763** rodamiento de Ø 23.8 mm  
kit reparación transmisión corta l/cambio  
completo con rodamiento, r.o. 7701464129



**339**  
fuelle transmisión corta lado cambio  
(sin rodamiento)



**1367**  
kit rep. transm. larga l/cbo. caña ancha  
r.o. 7701462101



**1626**  
kit rep. transm. larga l/cbo. caña estrecha  
r.o. 7701450617



**4100**  
soporte carburador 1.2-1.4  
r.o. 7700852033



**498**  
serreta pedal embrague completa  
r.o. 7700679621

## RENAULT EXPRESS



**584**  
soporte tubo de escape  
r.o. 7700779356



**280**  
soporte tubo de escape  
r.o. 7700686449



**748** Ø 66 mm  
collarín colector y enlace tubo de escape  
r.o. 7701459194



**2381**  
junta cónica colector escape Ø52 mm  
r.o. 7700797807



**2325**  
tapón de goma Ø 16 mm  
r.o.



**2326**  
tapón de goma Ø 20 mm  
r.o.

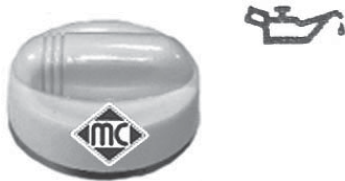

**3617**  
tapón llenado aceite Diesel F8Q  
r.o. 7700110770



**417**  
cubrepedal freno y embrague  
r.o. 7700680386

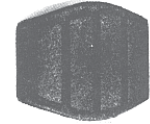

**670**  
tapón cárter aceite  
r.o. 7903075033



**942**  
capuchón protector Delco  
r.o.



**2001**  
arandela metaloplást. tapón cárter 16x22 mm  
r.o. 7703062062



**4036**  
bomba cebado manual gasoil con válvula  
antirretorno y boquilla adicional a 90°



**016**  
tapón cierre inyectores  
r.o.

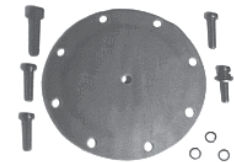

**832**  
jgo reparación membrana depresor Diesel  
r.o.

# RENAULT KANGOO

## CANALIZACIONES DE AGUA:

KANGOO 1.2 gasolina hasta '2/99 (motor D7F-710)

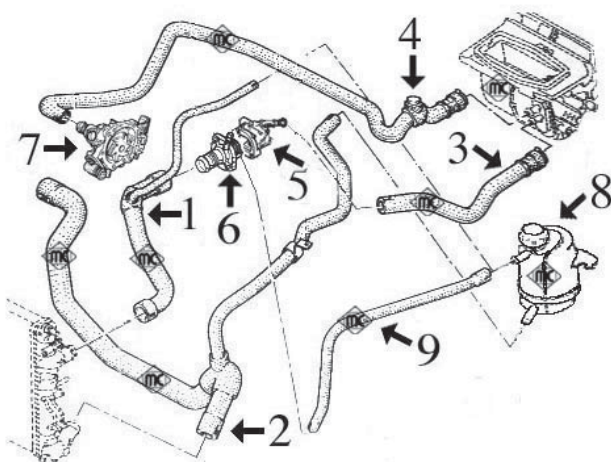

- 1- 8715 mgto superior radiador hasta 7/'98  
8739 mgto superior radiador desde 7/'98 hasta 2/'99
- 2- 8718 mgto inferior radiador
- 3- 8716 mgto de cuerpo termostato a calefactor
- 4- 8717 mgto de bomba de agua a calefactor
- 5- 3156 cuerpo de termostato (metálico) hasta 6/'98  
3669 cuerpo completo (plástico) con tapa y termostato desde 6/'98
- 6- 3147 tapa de aluminio con termostato hasta 6/'98  
(desde 6/'98 esta incorporada al cuerpo termostato ref. MC-3669)
- 7- 3033 boquilla metálica en tapa bomba de agua
- 8- 3563 tapón botella de expansión (1.4 bar)  
3567 botella de expansión
- 9- 117 mgto de botella a tapa termostato hasta 7/'98  
cortar de rollo MC-117 (Ø 10x17 mm)

KANGOO 1.2 gasolina desde '2/99:

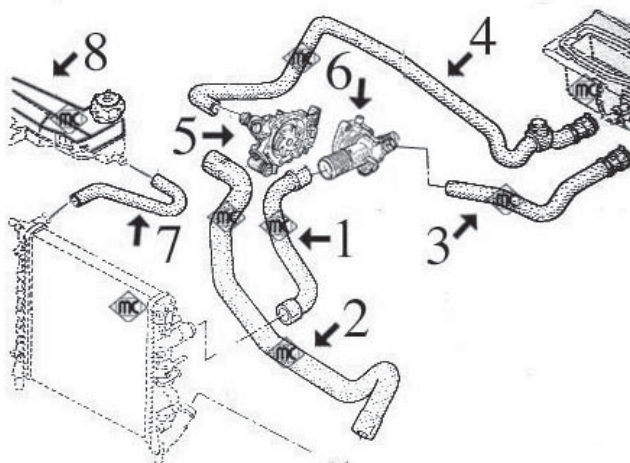

- 1- 8715 mgto superior radiador
- 2- 8713 mgto inferior radiador
- 3- 8716 mgto de cuerpo termostato a calefactor
- 4- 8717 mgto de bomba de agua a calefactor
- 5- 3033 boquilla metálica en tapa bomba de agua
- 6- 3669 cuerpo completo (plástico) con tapa y termostato
- 7- 8714 mgto de radiador a botella expansión
- 8- 3563 tapón botella de expansión (1.4 bar)  
3570 botella de expansión

KANGOO 1.4/1.6 gasolina 8 válvulas (motores E7J y K7M):

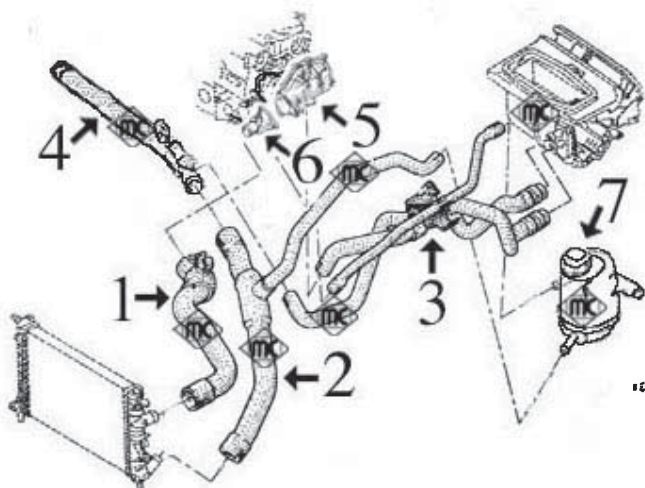

- 1- 8720 mgto superior radiador
- 2- 8721 mgto inferior radiador
- 3- 8722 mgto triple de calefactor
- 4- 3146 tubo de agua metálico
- 5- 3148 boquilla metálica en tapa aluminio
- 6- 3119 tapa de termostato
- 7- 3563 tapón botella de expansión (1.4 bar)  
3567 botella de expansión



- 8818 jgo mgtos desvaporizadores 1.4



# RENAULT KANGOO

## KANGOO 1.6 gasolina-16 válvulas (motores K4M-K4J):

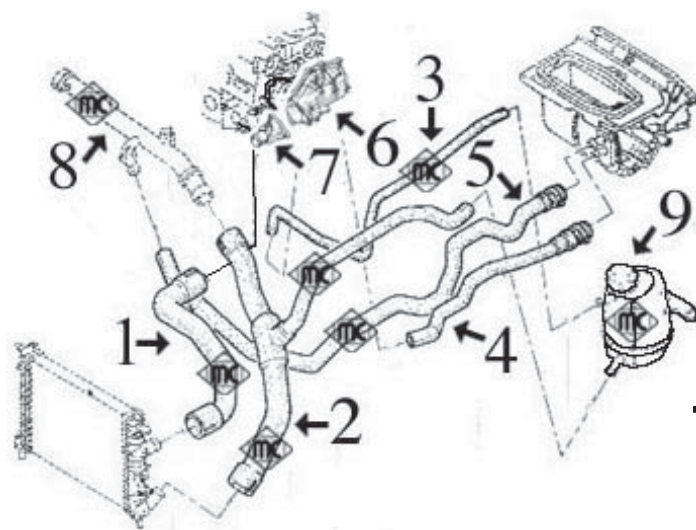

- 1- 8746 mgto superior radiador
- 2- 8747 mgto inferior radiador
- 3- 8758 mgto de botella a tapa de termostato
- 4- 8748 mgto de calefactor a cuerpo de termostato
- 5- 8754 mgto de calefactor a tubo rígido
- 6- 3148 boquilla metálica en cuerpo de termostato
- 7- 3119 tapa de termostato
- 8- 3663 tubo rígido (plástico)
- 9- 3563 tapón botella de expansión (1.4 bar)
- 3567 botella de expansión

~~8750~~ mgto desvaporizador

## KANGOO 1.9 Diesel (motor F8Q) versiones SININTERCAMBIADOR en filtro de aceite (sin aire acondicionado)

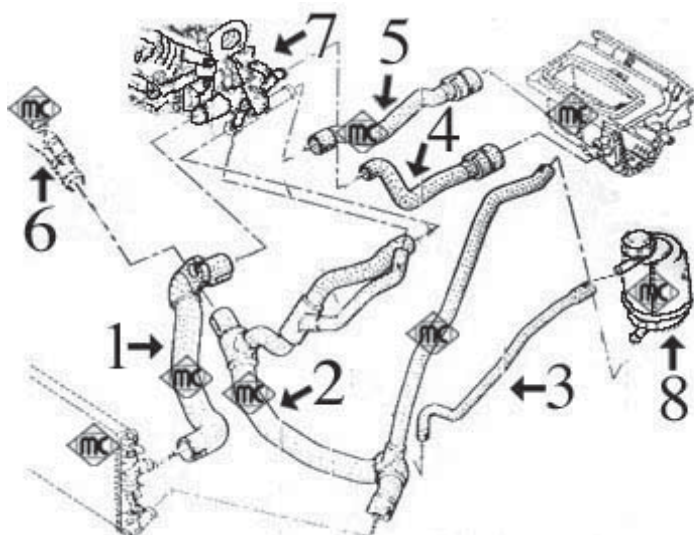

- 1- 8723 mgto superior radiador
- 2- 8724 mgto inferior radiador
- 3- 8726 mgto de botella a cuerpo de termostato
- 4- 8728 mgto inferior de calefactor a cuerpo termostato
- 5- 8729 mgto superior de calefactor a cuerpo termostato
- 6- 3662 tubo de agua en bloque motor (plástico)
- 7- 3569 cuerpo completo con termostato y accesorios
- 8- 3563 tapón botella de expansión (1.4 bar)
- 3567 botella de expansión

# RENAULT KANGOO

KANGOO 1.9 Diesel (motor F8Q) versiones CON INTERCAMBIADOR en filtro de aceite (con aire acondicionado)

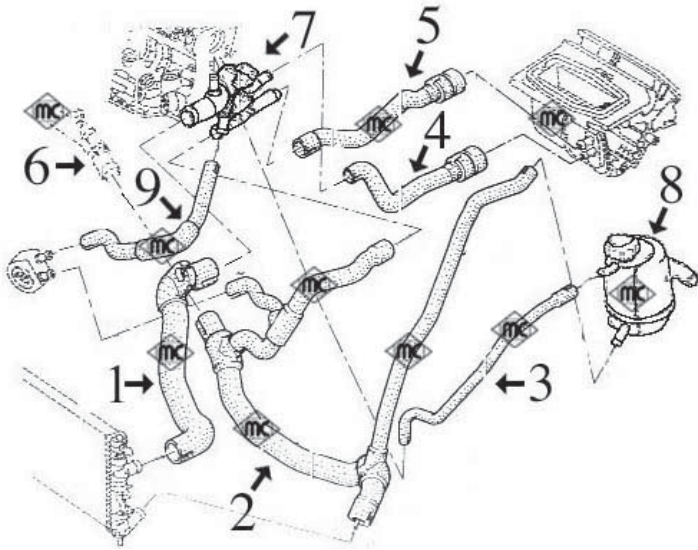

- 1- 8723 mgto superior radiador
- 2- 8725 mgto inferior radiador
- 3- 8726 mgto de botella a cuerpo de termostato
- 4- 8728 mgto inferior de calefactor a cuerpo termostato
- 5- 8729 mgto superior de calefactor a cuerpo termostato
- 6- 3662 tubo de agua en bloque motor (plástico)
- 7- 3569 cuerpo completo con accesorios (con termostato)  
3624 cuerpo completo con accesorios (sin termostato)
- 8- 3563 tapón botella de expansión (1.4 bar)  
3567 botella de expansión
- 9- 8727 mgto de intercambiador a cuerpo termostato

KANGOO 1.9 Diesel DTi (motor F9Q, desde '99)

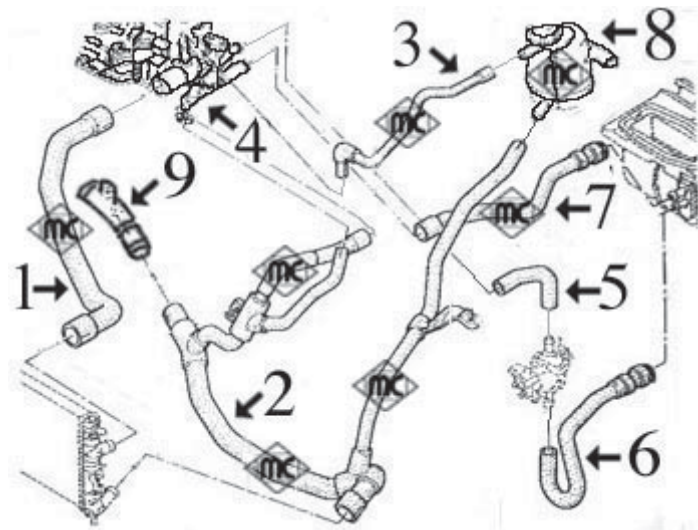

- 1- 8730 mgto superior radiador
- 2- 8732 mgto inferior radiador hasta 12/'00  
8731 mgto inferior radiador desde 12/'00
- 3- 8726 mgto de botella a cuerpo de termostato
- 4- 3569 cuerpo completo con accesorios (con termostato) hasta 12/'00  
3624 cuerpo completo con accesorios (sin termostato) hasta 12/'00  
3645 cuerpo de termostato completo desde 12/'00 con termostato de 89°  
3661 cuerpo de termostato completo desde 12/'00 con termostato de 83°
- 5- 8734 mgto de cuerpo termostato a termoinmensor
- 6- 8719 mgto de termoinmensor a calefactor
- 7- 8735 mgto de calefactor a cuerpo termostato
- 8- 3563 tapón botella de expansión (1.4 bar)  
3567 botella de expansión
- 9- 3662 tubo de agua en bloque motor (plástico)

# RENAULT KANGOO

## KANGOO 1.5 Diesel-DCi (motor K9K):

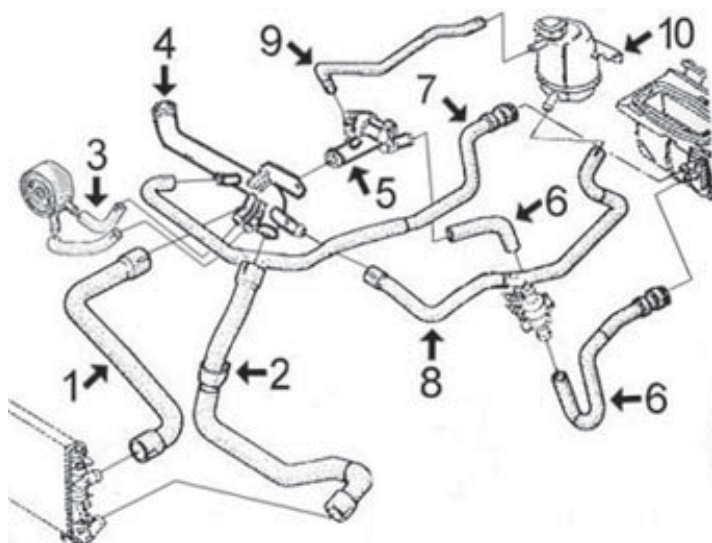

- 1- 8933 mgtto superior radiador
- 2- 8948 mgtto inferior radiador
- 3- 8941 jgo mgtos a intercambiador
- 4- 3187 tubo de agua
- 5- 3670 caja de termostato completa hasta 7/'03  
3679 caja de termostato completa desde 7/'03
- 6- 8947 jgo mgtos de caja termostato a termoinmensor y a calefactor
- 7- 8939 mgtto de calefactor a tubo
- 8- 8949 mgtto de botella a tubo
- 9- 8726 mgtto de sobrante de botella a caja termostato
- 10- 3563 tapón botella de expansión  
3567 botella de expansión



## MANGUITOS DESVAPORIZADORES motor F8Q 1.9D:

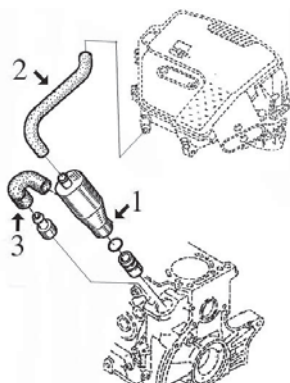

- 1- 3714 decantador completo con junta
- 2- 8751 mgtto de decantador a caja filtro
- 3- 8666 mgtto de decantador a bloque motor



## MANGUITOS DESVAPORIZADORES motor F9Q 1.9DTi:

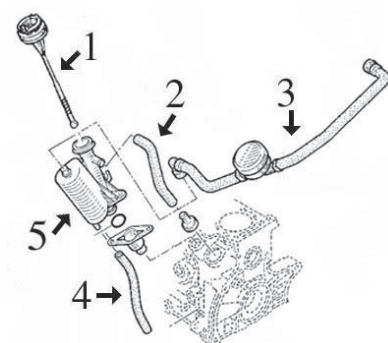

- 1- 4725 varilla nivel aceite
- 2- 8752 mgtto superior de caja reguladora a bloque
- 3- 9095 mgtto de caja reguladora a culata con válvula
- 4- 8753 mgtto inferior de caja reguladora a bloque
- 5- 3717 decantador completo con junta



## MANGUITOS DESVAPORIZADORES motor K9K-1.5DCi:

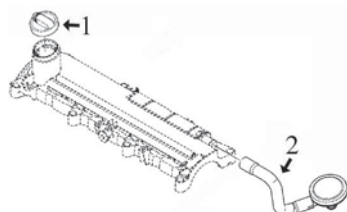

- 1- 3617 tapón llenado aceite motor
- 2- 3680 válvula desvaporizadora con manguito a tapa

# RENAULT KANGOO



**8666**  
mgto desvaporizador 1.9 Diesel  
r.o.



**8713**  
mgto inferior radiador 1.2  
r.o.



**8714**  
mgto de radiador a botella expansión 1.2



**8715**  
mgto superior radiador 1.2 desde '99  
r.o.



**8716**  
mgto de termostato a calefactor 1.2  
r.o.



**8717**  
mgto de bomba a calefactor 1.2  
r.o.



**8718**  
mgto inferior radiador 1.2  
r.o.



**8719**  
mgto de termoinmensor a calefactor 1.9 DTi  
r.o.



**8720**  
mgto superior radiador 1.4 - 1.6  
r.o.



**8721**  
mgto inferior radiador 1.4 - 1.6  
r.o.



**8722**  
conjunto mgto. de calefactor 1.4 - 1.6  
r.o.



**8723**  
mgto superior radiador 1.9 Diesel  
r.o.



**8724**  
mgto inferior radiador 1.9 Diesel  
r.o.



**8725**  
mgto inferior radiador 1.9 Diesel (aire ac.)  
r.o.



**8726**  
mgto de botella a cuerpo termostato 1.9 D  
r.o.



**8727**  
mgto de intercambiador a termostato 1.9 D  
r.o.



**8728**  
mgto calefactor a termostato 1.9 Diesel  
r.o.



**8729**  
mgto calefactor a termostato 1.9 Diesel  
r.o.



**8730**  
mgto superior radiador 1.9 DTi  
r.o.



**8731**  
mgto inferior radiador 1.9 DTi desde 12/'00  
r.o.



## RENAULT KANGOO



**8732**  
mgto inferior radiador 1.9 DTi hasta 12/'00  
r.o.



**8734**  
mgto de termostato a termostato 1.9DTi  
r.o.



**8735**  
mgto de calefactor a termostato 1.9 DTi  
r.o.

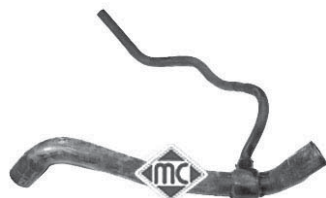

**8739**  
mgto superior radiador 1.2 desde '99  
r.o.



**8746**  
mgto superior radiador 1.6/16v  
r.o.



**8747**  
mgto inferior radiador 1.6/16v  
r.o.



**8748**  
mgto de calefactor a termostato 1.6/16v  
r.o.



**8750**  
mgto desvaporizador 1.6/16v  
r.o.



**8751**  
mgto desvaporizador 1.9 Diesel  
r.o.



**8752**  
mgto desvaporizador 1.9 DTi  
r.o.



**8753**  
mgto desvaporizador 1.9 DTi  
r.o.



**8754**  
mgto de calefactor a tubo 1.6/16v  
r.o.



**8758**  
mgto de botella a tapa termostato 1.6/16v  
r.o.



**8818**  
jgo mgto desvaporizadores 1.4-1.6  
r.o.



**8933**  
mgto sup radiador 1.5DCi  
r.o.



**8939**  
mgto de tubo a calefactor 1.5DCi  
r.o.



**8941**  
jgo mgto intercambiador 1.5DCi  
r.o.



**8947**  
jgo mgto de caja a termostato y a calefactor, r.o.



**8948**  
mgto inferior radiador 1.5DCi  
r.o.



**8949**  
mgto de tubo a botella 1.5DCi  
r.o.



**9095**  
mgto desvaporizador con válvula 1.9DTi  
r.o. 8200136128-80200063371

## RENAULT KANGOO



**3033** Ø 20 mm  
boquilla metálica en bomba de agua 1.2  
r.o. no hay despiece



**3119**  
tapa de termostato 1.4/8v-1.6/16v  
r.o. 7700866387



**3146**  
tubo de agua metálico 1.4-1.6  
r.o. 7700869985



**3147**  
cuerpo de termostato 1.2 hasta 6/'98  
r.o. 7700864962



**3148** Ø 18 mm  
boquilla metálica en cuerpo termost. 1.4-1.6  
r.o. no hay despiece



**3156**  
tapa con termostato 1.2 hasta 6/'98  
r.o. 7700868980

**¡Nuevo!**



**3187**  
tubo de agua 1.5DCi (K9K) hasta 7/'03  
r.o.



**3563**  
tapón botella de expansión (1.4 bar)  
r.o. 8200048024



**3567**  
botella de expansión 1.2-1.4-1.6-1.9D-  
-1.9DTi, r.o. 7701470460



**3569** CON TERMOSTATO  
cuerpo termost. completo con accesorios  
1.9D-DTi, r.o. 7701474249



**3570**  
botella de expansión 1.2 desde '99  
r.o. 7701471925



**3624** SIN TERMOSTATO  
cuerpo termost. completo con accesorios  
1.9D-DTi, r.o. 8200065390+8200065394

**¡Nuevo!**



**3645**  
caja con termostato de 89° 1.9D desde 12/'00  
r.o. 8200074346

**¡Nuevo!**



**3661**  
caja con termostato de 83° 1.9D desde 12/'00  
r.o. 8200074349

**¡Nuevo!**



**3662**  
boquilla entrada agua a motor 1.9D-1.9DTi  
r.o. 7700873948

**¡Nuevo!**



**3663**  
tubo de agua 1.6/16v  
r.o. 8200134513

**¡Nuevo!**



**3669**  
caja con termostato 1.2 desde 6/'98  
r.o. 7700110716

**¡Nuevo!**

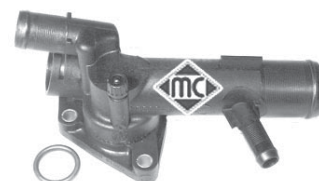

**3670**  
caja con termostato 1.5DCi hasta 7/'03  
r.o. 8200374994

**¡Nuevo!**

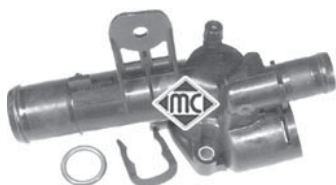

**3679**  
caja con termostato 1.5DCi desde 7/'03  
r.o. 8200267349

**¡Nuevo!**



**3680**  
válvula desvaporizadora 1.5DCi  
r.o.

**¡Nuevo!**



**3714**  
decantador completo 1.9D F8Q  
r.o.

## RENAULT KANGOO

**¡Nuevo!**



**3717**

decantador completo 1.9D F9Q

r.o.

## SUSPENSION DELANTERA y SOPORTES DE MOTOR transmisión 2x4:

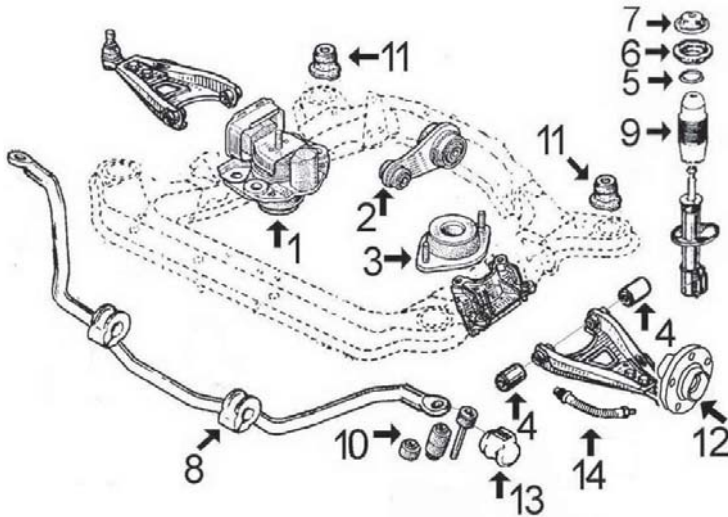

- 1- 4092 soporte motor derecho 1.2
- 4028 soporte motor derecho 1.4-1.6-1.6/16v y 1.9D
- 4158 soporte motor derecho 1.9DTi - 1.5DCi
- 2- 4093 tirante motor trasero, 1.2 hasta 7/'03
- 4675 tirante motor trasero, 1.2 desde 7/'03
- 972 tirante motor trasero 1.4/8v
- 4676 tirante motor trasero 1.6/16v
- 4165 tirante motor trasero 1.9D (F8Q)
- 4093 tirante motor trasero 1.9DTi hasta '00 (F9Q)
- 4102 tirante motor trasero 1.9DTi desde '00 (F9Q)
- 4073 tirante motor trasero 1.5DCi hasta '02
- 4676 tirante motor trasero 1.5DCi d/'02 hasta 7/'03
- 4675 tirante motor trasero 1.5DCi desde 7/'03
- 3- 973 soporte motor izquierdo todos modelos
- 4- 4094 silentbloc brazo suspensión
- 5- 4180 rodamiento soporte amortiguador
- 6- 4110 soporte amortiguador
- 7- 4153 tapa superior amortiguador con tuerca autoblocante
- 8- 868 goma central para barra estabilizadora de Ø 23 mm
- 4167 goma central para barra estabilizadora de Ø 24 mm
- 9- 998 capuchón amortiguador
- 10- 2655 bieleta puntal barra estabilizadora
- 11- 4289 silentbloc sub-chasis
- 12- 90020 buje rueda delantera 21 estrías
- 90068 buje rueda delantera 23 estrías
- 13- 2483 goma puntal barra estabilizadora 1.9D hasta '99
- 14- 96119 latiguillo freno delantero (357 mm)

## SUSPENSION TRASERA 2x4:

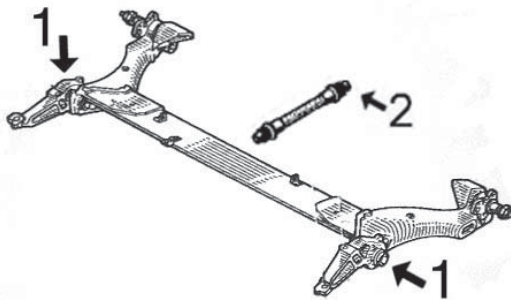

- 1- 4157 silentbloc articulación puente trasero
- 2- 96096 latiguillo freno trasero derecho (220 mm)
- 96119 latiguillo freno trasero izquierdo (357 mm)



## SUSPENSION DELANTERA y SOPORTES DE MOTOR transmisión 4x4:

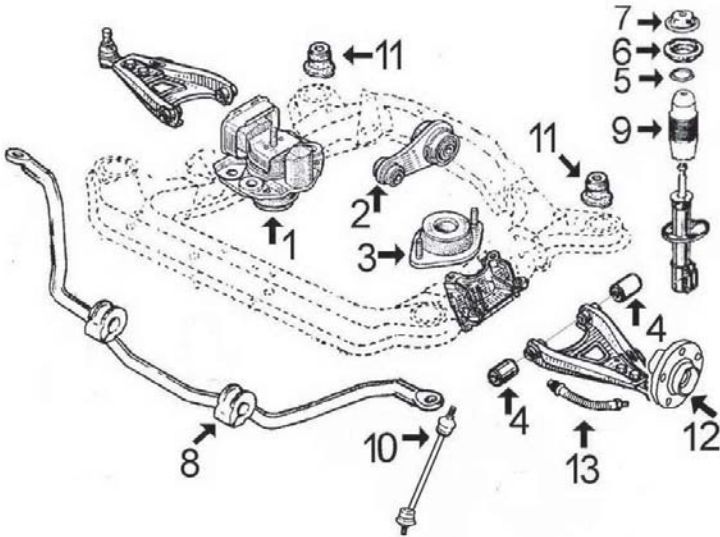

- 1- 4028 soporte motor derecho 1.6/16v y 1.9D
- 4158 soporte motor derecho 1.9DTi - 1.5DCi
- 2- 972 tirante motor trasero, 1.9D hasta '99 (F8Q)
- 4222 tirante motor trasero todos motores salvo F8Q
- 3- 973 soporte motor izquierdo
- 4- 4274 silentbloc brazo suspensión
- 5- 4180 rodamiento soporte amortiguador
- 6- 4110 soporte amortiguador
- 7- 4153 tapa superior amortiguador con tuerca autoblocante
- 8- 868 goma central para barra estabilizadora de Ø 23 mm
- 4167 goma central para barra estabilizadora de Ø 24 mm
- 9- 998 capuchón amortiguador
- 10- 4221 bieleta puntal barra estabilizadora
- 11- 4289 silentbloc sub-chasis
- 12- 90067 buje rueda delantera
- 13- 96119 latiguillo freno delantero sin ABS
- n/d latiguillo freno delantero con ABS

## SUSPENSION TRASERA 4x4:

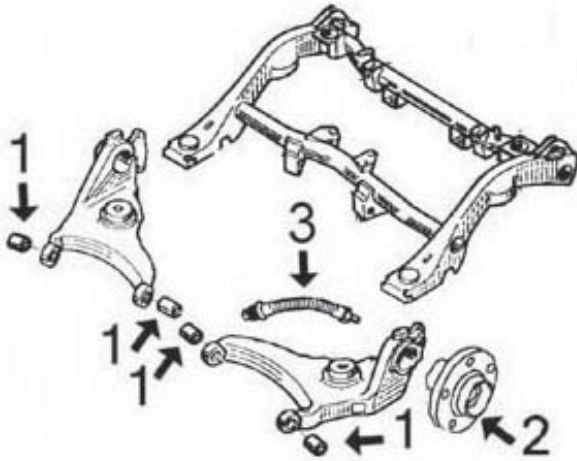

- 1- 4219 silentbloc brazo trasero
- 2- 90067 buje rueda trasera
- 3- 96096 latiguillo freno trasero derecho sin ABS (220 mm)
- 96119 latiguillo freno trasero izquierdo sin ABS (357 mm)
- n/d latiguillo freno trasero con ABS

## RENAULT KANGOO



**868**  
goma central para barra establz. de Ø 23 mm  
r.o. 7700785788



**972**  
tirante motor trasero 1.4-1.9D  
r.o. 7700424321



**973**  
soporte motor izquierdo  
r.o. 7700788318



**998**  
capuchón amortiguador delantero  
r.o. 7700802667-7700428440



**2483**  
goma puntal barra estabilizadora 1.9D hasta '99, r.o. 7700314855



**2655**  
bieteleta puntal barra estabilizadora  
r.o. 7700799404



**4028** hidráulico  
soporte motor derecho 1.4-1.9 D  
r.o. 7700434370



**4092**  
soporte motor derecho 1.2  
r.o. 7700415087

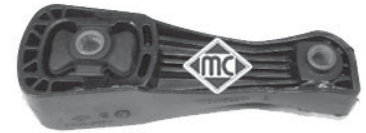

**4093**  
tirante motor trasero 1.2 y 1.9 DTi hasta '00  
r.o. 7700832264



**4094**  
silentbloc trapecio delantero  
r.o. 7700424399-7700419249



**4102**  
tirante motor trasero 1.9 DTi  
r.o. 7700432031-8200100116-8200148388



**4110**  
soporte amortiguador delantero  
r.o. 7700829529



**4153**  
tuerca superior amortiguador delantero  
r.o. 7700426450



**4157**  
silentbloc articulación puente trasero  
r.o. no hay despiece

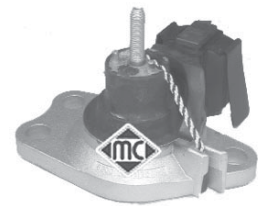

**4158**  
soporte motor derecho 1.9 DTi - DCi  
r.o. 8200170361



**4165**  
tirante motor trasero 1.9 Diesel  
r.o. 7700426193-7700415088



**4167**  
goma central para barra establz. de Ø 24 mm  
r.o. 7700835929



**4180**  
rodamiento soporte amortiguador delantero, r.o. 6001025850



**4219**  
silentbloc trapecio trasero 4x4  
r.o. 7700436707



**4221**  
bieteleta puntal barra estabilizadora 4x4  
r.o. 7700437136



**4222**  
soporte motor trasero 4x4  
r.o. 8200094942+7700436395

## RENAULT KANGOO



**4274**  
silentbloc trapecio delantero 4x4  
r.o. 7700437028



**4289**  
silentbloc soporte sub-chasis delantero  
r.o. 7700801875

**¡Nuevo!**



**4675**  
soporte motor trasero 1.2-1.5Dci desde '03  
r.o. 8200155207-8200175102

**¡Nuevo!**



**4676**  
soporte motor trasero 1.6/16v y 1.5DCi  
r.o. 8200151995



**90020**  
buje rueda delantera 2x4 de 21 estrías  
r.o. 7700768319

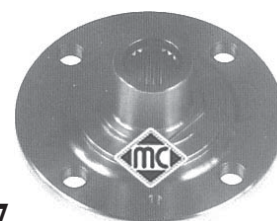

**90067**  
buje rueda delantera y trasera 4x4  
r.o. 7700830220



**90068**  
buje rueda delantera 2 x 4 de 23 estrías  
r.o. 7700415121



**96119**  
latiguillo freno delantero (357 mm)  
r.o. 7700313596



**96096**  
latiguillo freno trasero derecho (220 mm)  
r.o. 7700304969



**96119**  
latiguillo freno trasero izquierdo (357 mm)  
r.o. 7700313596

# RENAULT KANGOO

## ARTICULACIONES PALANCA DE CAMBIO

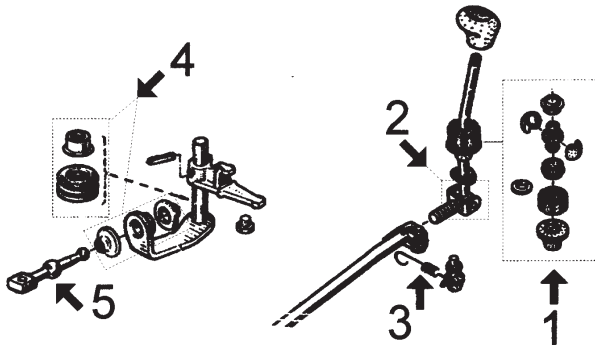

- 1- 516 juego casquillos rótula palanca
- 2- 2882 casquillo eje pasador palanca cambio
- 3- n/d muelle retorno palanca
- 4- 908 juego casquillos y retén selector
- 5- 2883 palanca del selector hasta '98
- 4287 palanca del selector desde '98

**516**

juego casquillos rótula palanca de cambio  
r.o. 7700464111



**908**

juego casquillos-retén extremo palanca de cambio, r.o. 7700679960+7703087163



**2882**

casquillo pasador eje palanca cambio  
r.o. 7700732903



**2883**

bieleta selector de velocidades completa hasta '99, r.o. 7700875584+7700872205



**4287**

bieleta selector de velocidades completa desde '99, r.o. 7700102476



**4297**

horquilla embrague completa 1.9D F8Q  
r.o. 7700725720+7700715851



**4677**

horquilla embrague completa 1.9D F9Q  
r.o. 7700861585



**1356**

fuelle derecho cremallera asistida "TRW"  
r.o. 7701469497-6000025546



**1530**

fuelle izquierdo cremallera asistida "TRW"  
r.o. 7701471141



**1558**

fuelle cremallera asistida "SMI" (dcho e izqd)  
r.o. 7701469496



**1647**

fuelle cremallera manual  
r.o. 7701470753



**1432**

palier de Ø 31 mm  
kit rep. transmisión l/rda 1.2-1.4-1.9  
r.o. 7701467125



**1607**

palier de Ø 35 mm  
kit rep. transmisión l/rueda 1.9D  
r.o. 7701469416



**1523**

kit rep. transmisión derecha l/cambio 1.4  
hasta '99, r.o.



**1559**

kit rep. transmisión derecha l/cambio 1.2  
todos y 1.4-1.9 desde '99, r.o. 7701471522





# RENAULT KANGOO



**1537** rodamiento de Ø 25,8 mm  
kit rep. transmisión izquierda l/cambio 1.2  
todos y 1.9 hasta '6/99, r.o.



**2304** rodamiento de Ø 28,0 mm  
kit rep. transmisión izquierda l/cambio 1.9  
desde 7/'99, r.o.



**1533** kit rep. transmisión derecha l/cambio 1.9  
hasta '99, r.o. 7701469418



**3619** tapón llenado aceite motor 1.6/16v  
r.o. 7700111741



**4725** varilla nivel aceite 1.9DTi  
r.o. 8200138515



**3617** tapón llenado aceite motor 1.9D-1.5D  
r.o. 7700110770



**584** soporte trasero tubo escape  
r.o. 7700779356



**2722** soporte central tubo escape  
r.o. 7700849461



**4114** soporte intermedio tubo escape  
r.o. 7700424341

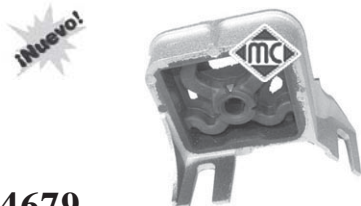

**4679** soporte escape 1.5DCi  
r.o. 7700435270



**4218** soporte tubo escape 4x4  
r.o. 7700434978



**4166** Ø 66 x 52 mm  
junta cónica escape a colector 1.9 Diesel  
r.o. 8200035310



**2849** polea cigueñal 1.9 D (motor F8Q)  
r.o. 7700112999



**4664** polea cigueñal 1.9 D (motor F8Q)  
r.o. 7700856673



**4163** polea cigueñal 1.9 DTi (motor F9Q)  
r.o.



**4455** polea cigueñal 1.9DTi (motor F9Q)  
r.o. 7700115766



**4666** 7 canales  
polea cigueñal 1.9DTi (motor F9Q)  
r.o. 8200297937



**4162** polea cigueñal 1.5 DCi hasta 7/'03  
r.o.



**4735** polea cigueñal 1.5 DCi desde 7/'03  
r.o. 8200477938



**4465** polea cigueñal 1.6/16v  
r.o. 8200313231



**4641** juego tapas arboles de levas 1.6/16v  
r.o. 7700106271+7700274026

## RENAULT KANGOO

<p><b>¡Nuevo!</b></p>  <p><b>4728</b> polea alternador <b>5 canales</b> r.o. 8200113636</p> <p style="text-align: right;"><b>sólida</b></p>	<p><b>¡Nuevo!</b></p>  <p><b>4729</b> polea alternador <b>6 canales</b> r.o. 7700110616</p> <p style="text-align: right;"><b>sólida</b></p>	<p><b>¡Nuevo!</b></p>  <p><b>4642</b> jgo juntas en tubo entrada Turbo 1.5DCi r.o. monta en 8200404193</p>
<p><b>¡Nuevo!</b></p>  <p><b>4947</b>                      <b>desembragable</b> polea alternador <b>5 canales</b> r.o. 8200113636</p>	<p><b>¡Nuevo!</b></p>  <p><b>4948</b>                      <b>desembragable</b> polea alternador <b>6 canales</b> r.o. 7700110616</p>	<p><b>¡Nuevo!</b></p>  <p><b>4994</b> polea árbol de levas 1.9DTi-DCi (F9Q) r.o. 7700866844-7700107401</p>
<p><b>¡Nuevo!</b></p>  <p><b>4912</b>                      <b>Ø 61,00 mm</b> polea de alternador de <b>rueda libre</b> r.o.</p>	<p><b>¡Nuevo!</b></p>  <p><b>4913</b>                      <b>Ø 53,30 mm</b> polea de alternador de <b>rueda libre</b> r.o.</p>	<p><b>¡Nuevo!</b></p>  <p><b>4914</b>                      <b>Ø 55,40 mm</b> polea de alternador de <b>rueda libre</b> r.o.</p>
 <p><b>667</b> tapón cárter de aceite 1.2-1.4 (16x150) r.o. 7703075210</p>	 <p><b>670</b> tapón cárter de aceite 1.9 r.o. 7703075033</p>	<p><b>¡Nuevo!</b></p>  <p><b>4717</b> cubrepedal freno y embrague r.o. 8200183752</p>
 <p><b>4149</b> soporte radiador r.o. 7700842041</p>		

# RENAULT LAGUNA - I (1993-2001)

## CANALIZACIONES DE AGUA HASTA '98

LAGUNA-I

1.8 motor F3P  
2.0 motor F3R

hasta '98  
hasta '98

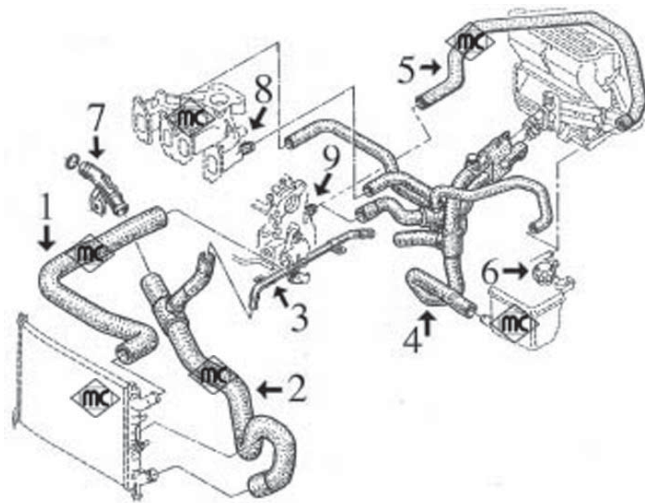

- 1- 8742 mgto superior radiador hasta 11/'95  
8743 mgto superior radiador desde 11/'95
- 2- 8740 mgto inferior radiador hasta 11/'95  
8741 mgto inferior radiador desde 11/'95
- 3- 3154 tubo de agua metálico (hasta 11/'95)
- 4- 8829 mgto múltiple de calefactor a botella y culata  
1.8 hasta 11/'95 (racor rápido)  
8828 mgto múltiple de calefactor a botella y culata  
2.0 hasta 11/'95 (racor rápido)  
8826 mgto múltiple de calefactor a botella y culata  
1.8-2.0 desde 11/'95 (rácor rápido)
- 5- n/d mgto de botella a culata
- 6- 3514 tapón botella radiador 1.20 bar  
3525 tapón botella radiador 1.40 bar  
3647 botella de expansión
- 7- 3108 boquilla metálica en bloque hasta 11/'95 (des-  
de 11/'95 es de plástico)
- 8- 3010 boquilla metálica en colector
- 9- 3033 boquilla metálica en culata

LAGUNA-I

2.2dT Diesel motor G8T hasta 11/'95 (códigos motores 706/790)

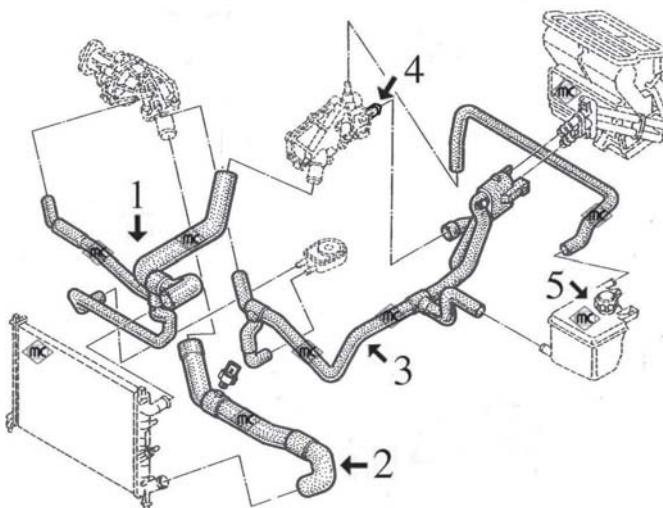

- 1- 8788 mgto superior radiador
- 2- 8790 mgto inferior radiador
- 3- 8852 mgto múltiple de calefactor a botella y culata  
(racor rápido)
- 4- 3033 boquilla metálica en caja termostato
- 5- 3514 tapón botella radiador 1.20 bar  
3525 tapón botella radiador 1.40 bar  
3647 botella de expansión

8883 juego mgts desvaporizadores



LAGUNA-I

2.2dT Diesel motor G8T desde 11/'95 (códigos motores 752/794) hasta '98

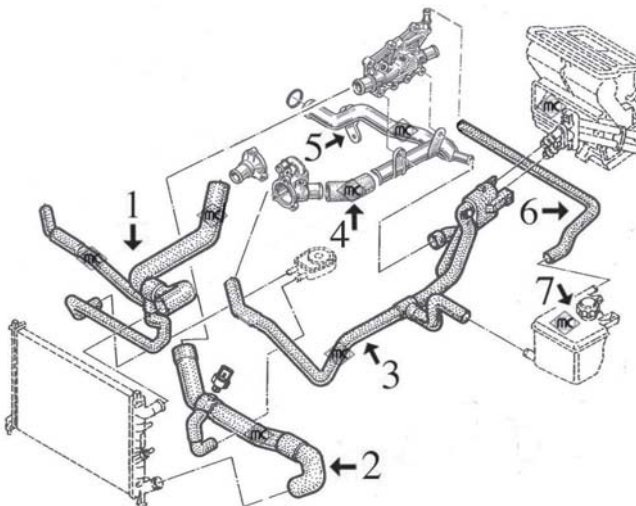

- 1- 8789 mgto superior radiador
- 2- 8791 mgto inferior radiador
- 3- 8827 mgto múltiple de calefactor a botella y tubo me-  
tálico (racor rápido)
- 4- 8792 mgto de tubo metálico a cuerpo termostato
- 5- 3155 tubo de agua metálico
- 6- n/d mgto de botella a tapa en culata
- 7- 3514 tapón botella radiador 1.20 bar  
3525 tapón botella radiador 1.40 bar  
3647 botella de expansión

8883 juego mgts desvaporizadores





# RENAULT LAGUNA - I (1993-2001)

## CANALIZACIONES DE AGUA DESDE '98:

LAGUNA-I

1.6-16v motor K4M desde '98

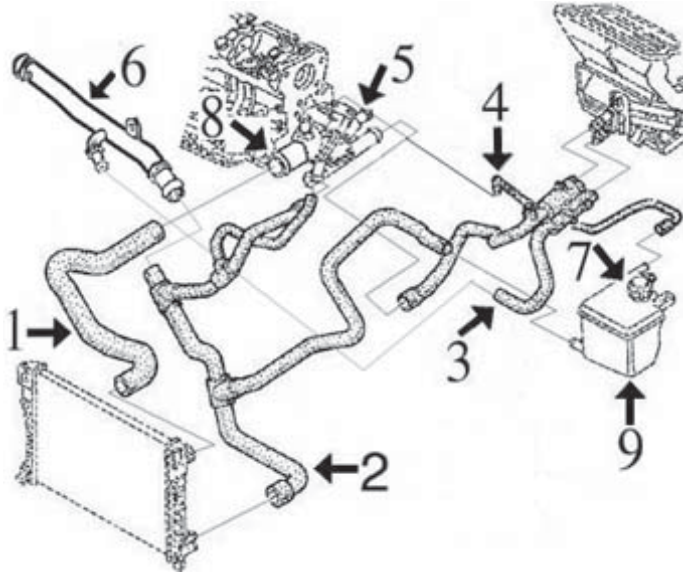

- 1- 8865 mgto superior radiador
- 2- 8871 mgto inferior radiador
- 3- 8860 mgto doble calefactor
- 4- n/d mgto de botella a caja termostato
- 5- 3148 boquilla metálica en caja termostato
- 6- 3663 tubo de agua (plástico)
- 7- 3514 tapón botella expansión 1.20 bar  
3525 tapón botella expansión 1.40 bar
- 8- 3119 tapa de termostato
- 9- 3647 botella de expansión

8750 mgto desvaporizador



LAGUNA-I

1.8-16v motor F4P desde '98  
2.0-16v motor F4R desde '98

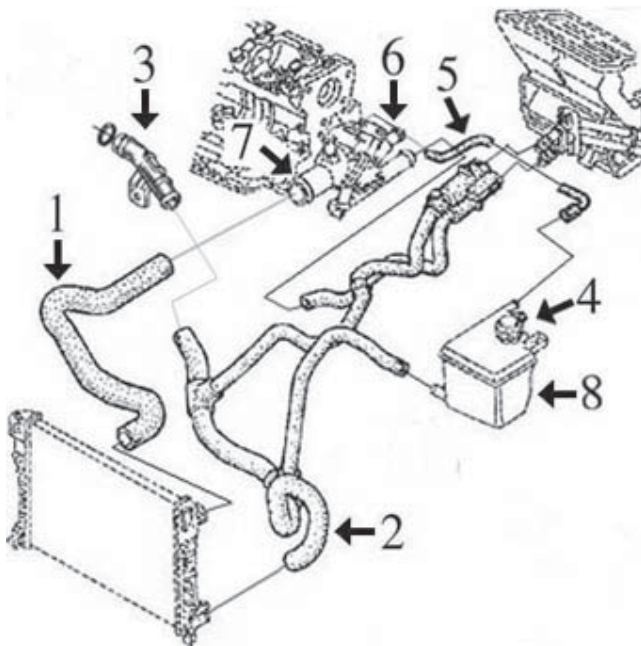

- 1- 8865 mgto superior radiador
- 2- 8855 mgto inferior radiador y calefactor
- 3- 3662 boquilla de mgto inferior a bloque motor (plástico)
- 4- 3514 tapón botella expansión 1.20 bar  
3525 tapón botella expansión 1.40 bar
- 5- n/d mgto de botella a caja de termostato
- 6- 3148 boquilla metálica en caja termostato
- 7- 3119 tapa de termostato
- 8- 3647 botella de expansión



# RENAULT LAGUNA - I (1993-2001)

LAGUNA-I

1.9DTi (100cv) desde '98:

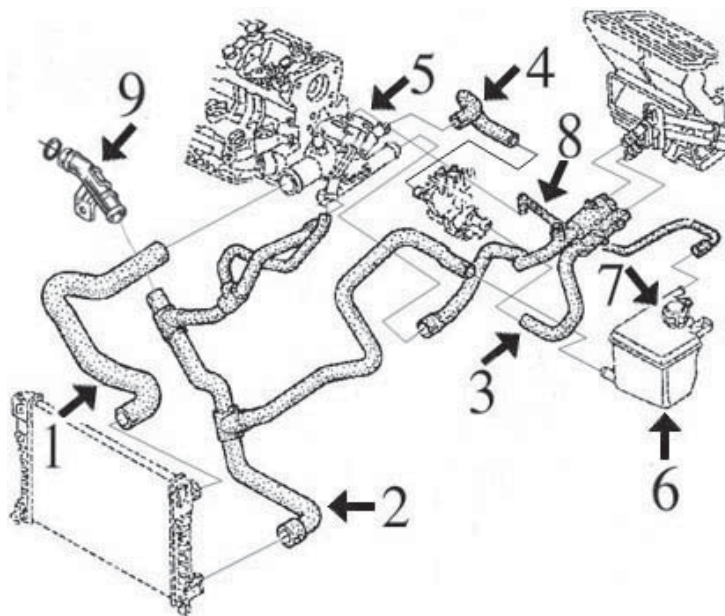

- 1- 8863 mgto superior radiador
- 2- 8858 mgto inferior radiador hasta 9/'99  
8859 mgto inferior radiador desde 9/'99
- 3- 8857 mgto doble entrada/salida calefactor
- 4- 8868 mgto de caja termostato
- 5- 3569 caja de termostato completa hasta 9/'99  
3645 caja de termostato completa desde 9/'99 con termostato de 89°  
3661 caja de termostato completa desde 9/'99 con termostato de 83°
- 6- 3647 botella de expansión
- 7- 3663 tubo de agua (plástico)
- 7- 3514 tapón botella expansión 1.20 bar  
3525 tapón botella expansión 1.40 bar
- 8- n/d mgto de botella a caja de termostato
- 9- 3662 boquilla de mgto inferior a bloque motor (plástico)

9095 mgto desvaporizador con válvula



LAGUNA-I

1.9DCi (110cv-120cv) desde '98:

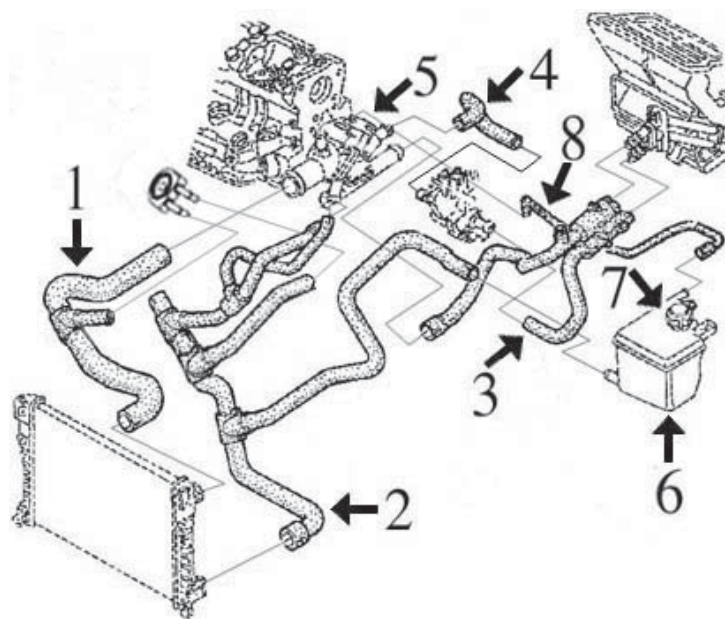

- 1- 8863 mgto superior radiador
- 2- 8862 mgto inferior radiador
- 3- 8857 mgto doble entrada/salida calefactor
- 4- 8869 mgto de caja termostato
- 5- 3569 caja de termostato completa hasta 9/'99  
3645 caja de termostato completa desde 9/'99 con termostato de 89°  
3661 caja de termostato completa desde 9/'99 con termostato de 83°
- 6- 3647 botella de expansión
- 7- 3663 tubo de agua (plástico)
- 7- 3514 tapón botella expansión 1.20 bar  
3525 tapón botella expansión 1.40 bar
- 8- n/d mgto de botella a caja de termostato

9095 mgto desvaporizador con válvula



## RENAULT LAGUNA - I (1993-2001)



**8740**  
mgto inferior radiador 1.8-2.0 hasta 11/'95  
r.o.



**8741**  
mgto inferior radiador 1.8-2.0 desde 11/'95  
r.o.



**8742**  
mgto superior radiador 1.8-2.0 hasta '95  
r.o.



**8743**  
mgto superior radiador 1.8-2.0 desde 11/'95  
r.o.



**8750**  
mgto desvaporizador 1.6/16v  
r.o.



**8788**  
mgto superior radiador 2.2dT hasta 11/'95  
r.o.



**8789**  
mgto superior radiador 2.2dT desde 11/'95  
r.o.



**8790**  
mgto inferior radiador 2.2dT hasta 11/'95  
r.o.



**8791**  
mgto inferior radiador 2.2dT desde 11/'95  
r.o.



**8792**  
mgto de tubo metálico a cuerpo termostato  
2.2dT desde 11/'95, r.o.



**8826**  
mgto múltiple de calefactor a botella y  
culata 1.8-2.0 desde 11/'95, r.o. 7700417717



**8827**  
mgto múltiple de calefactor a botella y  
culata 2.2dT desde 11/'95, r.o. 7700412560



**8828**  
mgto múltiple de calefactor a botella y  
culata 2.0 hasta 11/'95, r.o. 7700824560



**8829**  
mgto múltiple de calefactor a botella y  
culata 1.8 hasta 11/'95, r.o. 7700824558



**8852**  
mgto múltiple de calefactor a botella y  
culata 2.2dT hasta 11/'95, r.o. 7700826976



**8855**  
mgto inferior radiador 1.8/16v-2.0/16v mgto doble calefactor 1.9DTi-100cv  
r.o.



**8857**  
mgto inferior radiador 1.9DTi-100cv  
r.o.



**8858**  
mgto inferior radiador 1.9DTi hasta 9/'99  
r.o.



**8859**  
mgto inferior radiador 1.9DTi desde 9/'99  
r.o.



**8860**  
mgto doble calefactor 1.6/16v  
r.o.



**8862**  
mgto inferior radiador 1.9Dci 110-120cv  
r.o.

## RENAULT LAGUNA - I (1993-2001)

<p><b>¡Nuevo!</b></p>  <p><b>8863</b> mgto superior radiador 1.9Dci 110-120cv r.o.</p>	<p><b>¡Nuevo!</b></p>  <p><b>8865</b> mgto superior radiador 1.6/16v-1.8/16v-2.0 r.o.</p>	<p><b>¡Nuevo!</b></p>  <p><b>8868</b> mgto de caja entrada a pipa 1.9DTi r.o.</p>
<p><b>¡Nuevo!</b></p>  <p><b>8869</b> mgto de caja entrada a pipa 1.9Dci r.o.</p>	<p><b>¡Nuevo!</b></p>  <p><b>8871</b> mgto inferior radiador 1.6/16v r.o.</p>	<p><b>¡Nuevo!</b></p>  <p><b>8883</b> juego mgto desvaporizadores 2.2D (G8T) r.o.</p>
<p><b>¡Nuevo!</b></p>  <p><b>9095</b> mgto desvaporizador con válvula 1.9D r.o.</p>	 <p><b>3010</b> boquilla en colector 1.8-2.0 r.o. 7705030338</p>	 <p><b>3033</b> boquilla en culata 1.8-2.0 r.o. 7700861225</p>
 <p><b>3108</b> tubo en bloque motor 1.8-2.0 r.o. 7700866560</p>	 <p><b>3119</b> tapa de termostato 1.6-1.8-2.0 desde '98 r.o. 7700101179</p>	 <p><b>3148</b> boquilla en caja termost. 1.6-1.8-2.0 d/'98 r.o.</p>
 <p><b>3154</b> tubo de agua metálico 1.8-2.0 hasta 11/'95 r.o. 7700857041</p>	 <p><b>3155</b> tubo de agua metálico 2.2dT desde 11/'95 r.o. 7700862891</p>	 <p><b>3514</b> tapón botella radiador 1.20 bar r.o.</p>
 <p><b>3525</b> tapón botella radiador 1.20 bar r.o.</p>	 <p><b>3569</b>      <b>CON TERMOSTATO</b> cuerpo de termost. completo con accesorios 1.9DTi, r.o. 7701474249</p>	 <p><b>3624</b>      <b>SIN TERMOSTATO</b> cuerpo de termost. completo con accesorios 1.9DTi, r.o. 8200065392+8200065394</p>
<p><b>¡Nuevo!</b></p>  <p><b>3645</b> caja de termostato 1.9D desde '00 completa con termostato de 89°, r.o. 8200074346</p>	<p><b>¡Nuevo!</b></p>  <p><b>3646</b> caja de termostato 2.2D desde '00 completa con termostato, r.o. 8200262237</p>	<p><b>¡Nuevo!</b></p>  <p><b>3647</b> botella de expansión r.o. 7701467615</p>

## RENAULT LAGUNA - I (1993-2001)

**¡Nuevo!**



**3661**  
caja de termostato 1.9D desde '00 completa  
con termostato de 83°, r.o. 8200074349

**¡Nuevo!**



**3662**  
boquilla entrada a bloque 1.8/16v-2.0/16v y  
1.9DTi, r.o. 7700873948

**¡Nuevo!**



**3663**  
tubo de agua 1.6/16v  
r.o. 8200134513

**¡Nuevo!**



**3714**  
decantador completo 2.0 gasolina  
r.o.

**¡Nuevo!**



**3717**  
decantador completo 1.9D-F9Q  
r.o.



# RENAULT LAGUNA - I (1993-2001)

## SUSPENSION DELANTERA, TRASERA y SOPORTES DE MOTOR:

### LAGUNA-I MODELOSHASTA '98:

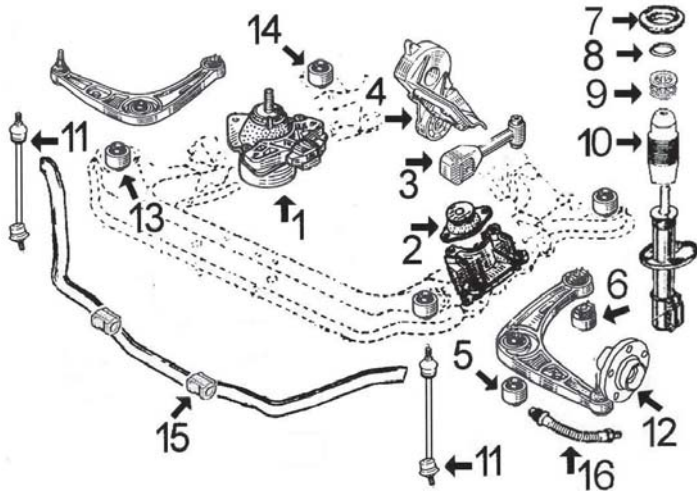

- 1- 4088 soporte motor derecho 1.8  
4183 soporte motor derecho 2.0  
2897 soporte motor derecho 2.2dT y 16v.
- 2- 2898 soporte motor izquierdo 1.8 - 2.0  
4091 soporte motor izquierdo 2.2dT y 16v.
- 3- 4072 soporte motor trasero 1.8-2.0 cambio manual  
4309 soporte motor trasero 1.8-2.0 cambio automático
- 4- 4592 silentbloc en soporte motor trasero 2.2dT y 16v. completo con tirante posterior
- 5- 2664 silentbloc anterior trapecio delantero
- 6- 2663 silentbloc posterior trapecio delantero
- 7- 4029 soporte amortiguador delantero derecho  
4030 soporte amortiguador delantero izquierdo
- 8- 4178 rodamiento soporte amortiguador
- 9- n/d tope de goma amortiguador delantero
- 10- 4173 capuchón amortiguador
- 11- 4243 bieleta puntal barra estabilizadora
- 12- 90067 buje rueda delantera
- 13- 4606 silentbloc anterior cuna delantera
- 14- 4607 silentbloc posterior cuna delantera
- 15- 4471 goma barra estabilizadora
- 16- 96105 latiguillo freno delantero (480 mm)

### LAGUNA-I MODELOSDESDE '98:

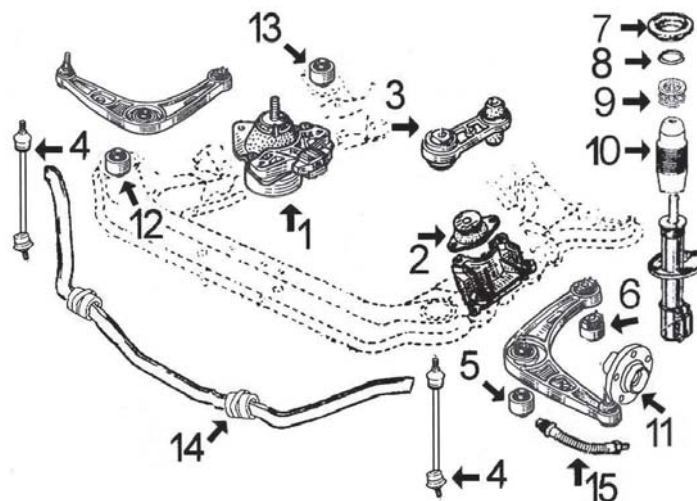

- 1- 4087 soporte motor derecho 1.6-1.8-2.0  
2897 soporte motor derecho 1.9DTi
- 2- 4091 soporte motor izquierdo
- 3- 4089 soporte motor trasero 1.6-1.8-2.0 gasolina y 1.9 Dti de 100 CV  
4090 soporte motor trasero 1.9DTi de 110-120 CV
- 4- 4243 bieleta puntal barra estabilizadora
- 5- 2664 silentbloc anterior trapecio delantero
- 6- 2663 silentbloc posterior trapecio delantero
- 7- 4029 soporte amortiguador delantero derecho  
4030 soporte amortiguador delantero izquierdo
- 8- 4178 rodamiento soporte amortiguador
- 9- n/d tope de goma amortiguador delantero
- 10- 4173 capuchón amortiguador
- 11- 90067 buje rueda delantera
- 12- 4606 silentbloc anterior cuna delantera
- 13- 4607 silentbloc posterior cuna delantera
- 14- 4471 goma barra estabilizadora
- 15- 96105 latiguillo freno delantero (480 mm)

### SUSPENSIÓN TRASERA todos modelos

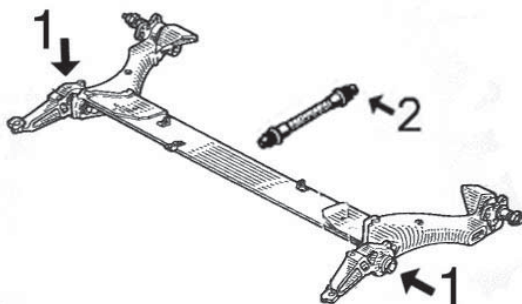

- 1- 4262 silentbloc articulación puente trasero
- 2- 96065 latiguillo freno trasero sin ABS (305 mm)  
96112 latiguillo freno trasero con ABS (180 mm)

## RENAULT LAGUNA - I (1993-2001)

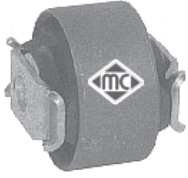

**2663**  
silentbloc posterior trapezio delantero  
r.o. 7700824042



**2664**  
silentbloc anterior trapezio delantero  
r.o. 7700822503



**2897** **hidráulico**  
soporte motor derecho 2.2dT y 16v. hasta '98, r.o. 7700414099-7700824066



**2898**  
soporte motor izquierdo 1.8-2.0 hasta '98  
r.o. 7700818369



**4029**  
soporte amortiguador delantero derecho  
r.o. 7700832420



**4030**  
soporte amortiguador delantero izquierdo  
r.o. 7700832419



**4072**  
soporte motor trasero 1.8-2.0 hasta '98  
**cambio manual**, r.o. 7700817782



**4087**  
soporte motor derecho 1.6-1.8-2.0 desde '98, r.o. 7700423007



**4088**  
soporte motor derecho 1.8 hasta '98  
r.o. 7700823949



**4089**  
soporte motor trasero 1.6-1.8-2.0 y 1.9Dti de 100CV desde '98, r.o. 7700422529



**4090**  
soporte motor trasero 1.9Dci 110-120 CV  
r.o. 7700411189



**4091**  
soporte motor izqdo. 2.2dT y 16v hasta '98  
y todos mods. desde '98, r.o. 7700818372



**4173**  
capuchón amortiguador delantero  
r.o. 7700776743



**4178**  
rodamiento soporte amortiguador delt.  
r.o. 7700803635



**4183** **hidráulico**  
soporte motor derecho 2.0 hasta '98  
r.o. 7700823950



**4243**  
bieleta puntal barra estabilizadora  
r.o. 7700805494



**4262**  
silentbloc articulación puente trasero  
r.o.



**4309**  
soporte motor trasero 1.8-2.0 **cambio automático**, r.o. 7700817783

**¡Nuevo!**







**4471**  
goma barra estabilizadora delantera  
r.o. 7704000661

**¡Nuevo!**























**4592**  
soporte motor trasero 2.2D hasta '98 completo con tirante, r.o.

## RENAULT LAGUNA - I (1993-2001)

<p><b>iNuevo!</b></p>  <p><b>4606</b> silentbloc anterior soporte cuna delantera r.o. 7700824709</p>	<p><b>iNuevo!</b></p>  <p><b>4607</b> silentbloc posterior soporte cuna delantera r.o. 7700826216</p>	 <p><b>90067</b> buje rueda delantera (23 estrías) r.o. 7700830220</p>
 <p><b>96105</b> latiguillo freno delantero (480 mm) r.o. 7700834731</p>	 <p><b>96065</b> latiguillo freno trasero sin ABS (305 mm) r.o. 7704003905</p>	 <p><b>96112</b> latiguillo freno trasero con ABS (180 mm) r.o. 7704002443</p>
<p><b>iNuevo!</b></p>  <p><b>4465</b> polea cigueñal 1.6/16v (K4M) r.o. 8200313231</p>	<p><b>iNuevo!</b></p>  <p><b>4464</b> polea cigueñal 1.8/16v (F4P) r.o. 8200276838-8200451065</p>	<p><b>iNuevo!</b></p>  <p><b>4577</b> polea cigueñal 2.0/8v (F3R) r.o. 7700109262-8200458960</p>
<p><b>iNuevo!</b></p>  <p><b>4611</b> polea cigueñal 2.0/16v (F4R) r.o. 8200451073</p>	<p><b>iNuevo!</b></p>  <p><b>4774</b> polea cigueñal 1.8/16v (F4P) r.o. 8200386453</p>	<p><b>iNuevo!</b></p>  <p><b>4455</b> polea cigueñal 1.9DTi r.o. 7700115766-8200079183</p>
<p><b>iNuevo!</b></p>  <p><b>4666</b> polea cigueñal 1.9DTi r.o. 8200297937</p>	<p><b>iNuevo!</b></p>  <p><b>4163</b> polea cigueñal 1.9DTi r.o. 7700115309</p>	<p><b>iNuevo!</b></p>  <p><b>2851</b> polea cigueñal 2.2D (G8T) hasta '96 r.o. 7700858731</p>
<p><b>iNuevo!</b></p>  <p><b>4489</b> polea cigueñal 2.2D (G8T) desde '96 r.o. 8200104292</p>	<p><b>iNuevo!</b></p>  <p><b>4463</b> polea cigueñal 2.2DTi (G9T) r.o. 8200468081-8200313058</p>	<p><b>iNuevo!</b></p>  <p><b>4585</b> polea cigueñal 2.2DTi (G9T) r.o. 8200207435-8200458171</p>
<p><b>iNuevo!</b></p>  <p><b>4728</b> polea alternador 5 canales sólida r.o.</p>	<p><b>iNuevo!</b></p>  <p><b>4729</b> polea alternador 6 canales sólida r.o.</p>	



## RENAULT LAGUNA - I (1993-2001)

<p><b>¡Nuevo!</b></p>  <p><b>4947</b> desembragable polea alternador <b>5 canales</b> r.o. 8200113636</p>	<p><b>¡Nuevo!</b></p>  <p><b>4948</b> desembragable polea alternador <b>6 canales</b> r.o. 7700110616</p>	<p><b>¡Nuevo!</b></p>  <p><b>4994</b> polea árbol de levas 1.9DTi-DCi (F9Q) r.o. 7700866844-7700107401</p>
<p><b>¡Nuevo!</b></p>  <p><b>4912</b> Ø 61,00 mm polea de alternador de <b>rueda libre</b> r.o.</p>	<p><b>¡Nuevo!</b></p>  <p><b>4913</b> Ø 53,30 mm polea de alternador de <b>rueda libre</b> r.o.</p>	<p><b>¡Nuevo!</b></p>  <p><b>4914</b> Ø 55,40 mm polea de alternador de <b>rueda libre</b> r.o.</p>
 <p><b>908</b> juego casquillos retén palanca selector r.o. 7700679960-7703087163</p>	 <p><b>2883</b> bieleta selector de velocidades completa r.o. 7700875584+7700872205</p>	 <p><b>4287</b> bieleta selector de velocidades desde '98 r.o. 7700102476</p>
 <p><b>4297</b> horquilla embrague 1.9D hasta '99 r.o. 7700715851</p>	<p><b>¡Nuevo!</b></p>  <p><b>4677</b> horquilla embrague 1.9D desde '99 r.o. 7700861585</p>	<p><b>¡Nuevo!</b></p>  <p><b>4725</b> varilla nivel aceite 1.9D r.o. 8200138515</p>
<p><b>¡Nuevo!</b></p>  <p><b>4724</b> varilla nivel aceite 2.2Dci r.o. 8200086556</p>	<p><b>¡Nuevo!</b></p>  <p><b>3648</b> tapón llenado aceite 2.2D r.o. 7700870192</p>	<p><b>¡Nuevo!</b></p>  <p><b>3617</b> tapón llenado aceite 1.9 Diesel r.o. 7700110720</p>
<p><b>¡Nuevo!</b></p>  <p><b>3619</b> tapón llenado aceite 1.6/16v r.o. 7700111741</p>	<p><b>¡Nuevo!</b></p>  <p><b>4641</b> jgo tapas en culata (árboles de levas) 1.6/16v y 2.0/16v, 7700106271+7700274026</p>	 <p><b>1355</b> fuelle cremallera dirección asistida r.o. 7701469657</p>
 <p><b>1517</b> kit rep. transmisión l/rueda (homocinética de Ø88 mm), r.o. 7701469021</p>	 <p><b>1432</b> kit rep. transmisión l/rueda (homocinética de Ø84 mm), r.o. 7701034800</p>	<p><b>¡Nuevo!</b></p>  <p><b>1135</b> kit fuelle transmisión <b>derecha</b> l/cambio r.o. 7701470910</p>



## RENAULT LAGUNA - I (1993-2001)



**2304** rodamiento de Ø 28.0 mm  
kit rep. transmisión izquierda l/cambio  
(Ø exterior boca grande 114 mm)



**1139** rodamiento de Ø 28.0 mm  
kit rep. transmisión izquierda l/cambio  
(Ø exterior boca grande 105 mm)



**2382** Ø 90 x 73 mm  
junta cónica colector escape  
r.o. 7700766353



**2763**  
soporte tubo de escape  
r.o. 7700828897



**670**  
tapón cárter de aceite todos modelos  
r.o. 7903075033

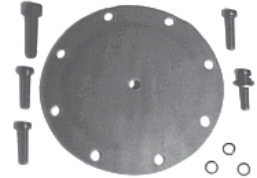

**832**  
jgo reparación bomba de vacío  
r.o.

**nuevo!**



**4709**  
soporte filtro de aire (largo)  
r.o. 7700744145



**153**  
soporte filtro de aire (corto)  
r.o. 7704002509

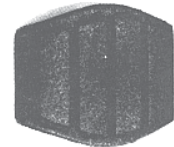

**417**  
cubrepedal freno y embrague  
r.o. 7700832177

# RENAULT LAGUNA - II (2001- )

## SUSPENSION DELANTERA y SOPORTES DE MOTOR:

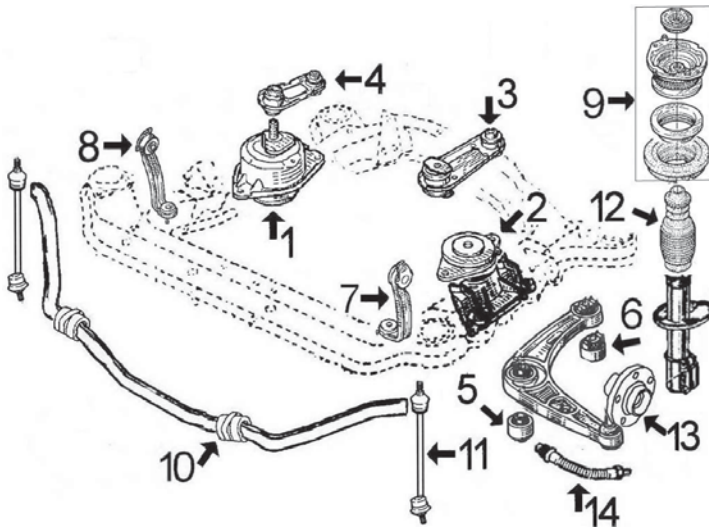

- 1- 4461 soporte motor derecho
- 2- 4462 soporte motor izquierdo
- 3- 4468 soporte motor trasero 1.6-1.8-2.0-1.9D  
4467 soporte motor trasero cambio automático
- 4- 4469 bieleta antipar en soporte derecho 1.6-1.8-2.0  
4466 bieleta antipar en soporte derecho 1.9D-2.2D
- 5- 4487 silentbloc anterior trapecio delantero
- 6- 4488 silentbloc posterior trapecio delantero
- 7- 4587 bieleta izquierda soporte cuna motor
- 8- 4588 bieleta derecha soporte cuna motor
- 9- 4572 soporte amortiguador delantero completo con rodamiento y accesorios
- 10- 4471 goma barra estabilizadora
- 11- 4457 bieleta puntal barra estabilizadora
- 12- 4827 capuchón amortiguador delantero
- 13- n/d buje rueda delantera
- 14- 96171 latiguillo freno delantero

## SUSPENSION TRASERA:

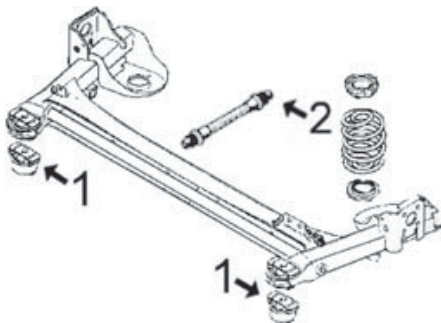

- 1- 4476 juego silentblocs soporte puente trasero
- 2- 96177 latiguillo freno trasero

**¡Nuevo!**



**4457**  
bieleta puntal barra estabilizadora  
r.o. 8200002870

**¡Nuevo!**



**4461**  
soporte motor derecho  
r.o. 8200181590

**¡Nuevo!**



**4462**  
soporte motor izquierdo  
r.o. 8200357462

**¡Nuevo!**



**4466**  
bieleta antipar en soporte derecho 1.9D-2.2D  
r.o. 8200400177-8200250743

**¡Nuevo!**



**4467**  
soporte motor trasero 2.2D y automáticos  
r.o. 8200000003-8200371093

**¡Nuevo!**



**4468**  
soporte motor trasero 1.6-1.8-2.0-1.9D  
r.o. 8200000002

## RENAULT LAGUNA - II (2001- )

**¡Nuevo!**



**4469**

bieleta antipar en soporte derecho 1.6-1.8-2.0  
r.o. 820000010-8200358666

**¡Nuevo!**



**4471**

goma barra estabilizadora  
r.o. 8200272594

**¡Nuevo!**



**4476**

juego silentblocs soporte puente trasero  
r.o. 8200427868+8200427869

**¡Nuevo!**



**4487**

silentbloc anterior trapecio delantero  
r.o. 8200002868

**¡Nuevo!**



**4488**

silentbloc posterior trapecio delantero  
r.o. 8200002869

**¡Nuevo!**



**4572**

soporte amortiguador delantero completo  
con rodamiento, r.o. 7701207537

**¡Nuevo!**



**4587**

soporte izquierdo sub-chasis delantero  
r.o. 8200000514

**¡Nuevo!**



**4588**

soporte derecho sub-chasis delantero  
r.o. 8200000515

**¡Nuevo!**



**4827**

capuchón amortiguador delantero  
r.o. 7700833756

**¡Nuevo!**



**96171**

latiguillo freno delantero (410 mm)  
r.o. 7701050070

**¡Nuevo!**



**96177**



latiguillo freno trasero (210 mm)  
r.o. 7701050073

## RENAULT LAGUNA - II (2001- )

<p><b>¡Nuevo!</b></p>  <p><b>9095</b> mgto desvaporizador 1.9D con válvula reguladora, r.o. 8200136128</p>	<p><b>¡Nuevo!</b></p>  <p><b>4724</b> varilla nivel aceite 2.2Dci r.o. 8200086556</p>	<p><b>¡Nuevo!</b></p>  <p><b>4725</b> varilla nivel aceite 1.9DTi r.o. 8200138515</p>
 <p><b>3619</b> tapón llenado aceite 1.6/16v r.o. 7700111741</p>	 <p><b>3617</b> tapón llenado aceite 1.9D (F9Q) r.o. 7700110720</p>	<p><b>¡Nuevo!</b></p>  <p><b>3648</b> tapón llenado aceite 2.2D (G9T) r.o. 7700870192</p>
<p><b>¡Nuevo!</b></p>  <p><b>4465</b> polea cigüeñal 1.6/16v (K4M) r.o. 8200313231</p>	<p><b>¡Nuevo!</b></p>  <p><b>4464</b> polea cigüeñal 1.8/16v (F4P) y 2.0/16v (F4R) r.o. 8200276838-8200451065</p>	<p><b>¡Nuevo!</b></p>  <p><b>4611</b> polea cigüeñal 2.0/16v (F4R) r.o. 8200451073</p>
<p><b>¡Nuevo!</b></p>  <p><b>4774</b> polea cigüeñal 1.8/16v (F4P) r.o. 8200386453</p>	<p><b>¡Nuevo!</b></p>  <p><b>4455</b> polea cigüeñal 1.9DTi r.o. 7700115766-8200079183</p>	<p><b>¡Nuevo!</b></p>  <p><b>4666</b> polea cigüeñal 1.9DTi r.o. 8200297937</p>
 <p><b>4163</b> polea cigüeñal 1.9DTi r.o.</p>	<p><b>¡Nuevo!</b></p>  <p><b>4463</b> polea cigüeñal 2.2Dci (G9T) r.o. 8200468081-8200313058</p>	<p><b>¡Nuevo!</b></p>  <p><b>4585</b> polea cigüeñal 2.2Dci (G9T) r.o. 8200207435-8200458171</p>
<p><b>¡Nuevo!</b></p>  <p><b>4577</b> polea cigüeñal 2.0/8v (F3R) r.o. 7700109260</p>	<p><b>¡Nuevo!</b></p>  <p><b>4728</b> polea alternador 5 canales SOLIDA r.o.</p>	<p><b>¡Nuevo!</b></p>  <p><b>4729</b> polea alternador 6 canales SOLIDA r.o.</p>
<p><b>¡Nuevo!</b></p>  <p><b>4947</b> polea alternador 5 canales DESEMBRAGABLE, r.o. 8200113636</p>	<p><b>¡Nuevo!</b></p>  <p><b>4948</b> polea alternador 6 canales DESEMBRAGABLE, r.o. 7700110616</p>	<p><b>¡Nuevo!</b></p>  <p><b>4994</b> polea árbol de levas 1.9DTi-DCi (F9Q) r.o. 7700866844-7700107401</p>



## RENAULT LAGUNA - II (2001- )

<p><b>¡Nuevo!</b></p>  <p><b>3645</b> caja de termostato completa 1.9D con termostato de 89°, r.o. 8200074346</p>	<p><b>¡Nuevo!</b></p>  <p><b>3661</b> caja de termostato completa 1.9D con termostato de 83°, r.o. 8200074349</p>	<p><b>¡Nuevo!</b></p>  <p><b>3646</b> caja de termostato completa 2.2D r.o. 8200262241</p>
<p><b>¡Nuevo!</b></p>  <p><b>3714</b> decantador completo 2.0 gasolina r.o.</p>	<p><b>¡Nuevo!</b></p>  <p><b>3717</b> decantador completo 1.9D-F9Q r.o.</p>	
<p><b>¡Nuevo!</b></p>  <p><b>4912</b>                      <b>Ø 61,00 mm</b> polea de alternador de rueda libre r.o.</p>	<p><b>¡Nuevo!</b></p>  <p><b>4913</b>                      <b>Ø 53,30 mm</b> polea de alternador de rueda libre r.o.</p>	<p><b>¡Nuevo!</b></p>  <p><b>4914</b>                      <b>Ø 55,40 mm</b> polea de alternador de rueda libre r.o.</p>
 <p><b>1517</b> kit rep. transmisión l/rueda (homocinética de Ø88 mm), r.o. 7701469021</p>	<p><b>¡Nuevo!</b></p>  <p><b>1134</b> kit rep. transmisión l/rueda (homocinética de Ø98 mm), r.o. 7701472975</p>	<p><b>¡Nuevo!</b></p>  <p><b>1135</b> kit fuelle transmisión derecha l/cambio r.o. 7701470910</p>
 <p><b>2304</b>                      <b>rodamiento de Ø 28.0 mm</b> kit rep. transmisión izquierda l/cambio (Ø exterior boca grande 114 mm)</p>	<p><b>¡Nuevo!</b></p>  <p><b>1139</b>                      <b>rodamiento de Ø 28.0 mm</b> kit rep. transmisión izquierda l/cambio (Ø exterior boca grande 105 mm)</p>	<p><b>¡Nuevo!</b></p>  <p><b>1136</b> fuelle cremallera dirección r.o. 7701472765</p>
<p><b>¡Nuevo!</b></p>  <p><b>4641</b> jgo tapas en culata para árboles de levas 1.4/16v y 2.0/16v, 7700106271+7700274026</p>	<p><b>¡Nuevo!</b></p>  <p><b>4470</b> soporte tubo de escape r.o. 8200017025</p>	<p><b>¡Nuevo!</b></p>  <p><b>4717</b> cubrepedal freno y embrague r.o. 7700416724-8200183752</p>
 <p><b>670</b> tapón cárter de aceite r.o. 7903075033</p>		

## RENAULT MASTER-I (1980-1998)



**1733-E** para montar con cono  
kit rep. transmisión l/rueda (trípode Ø 98)  
r.o. 7701013275

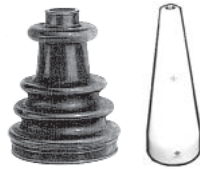

**1629-E** para montar con cono  
kit reparación transmisión l/rueda  
(homocinética de Ø 102) r.o. 7701201810



**1733**  
kit rep. transmisión l/rueda (trípode Ø 98)  
r.o. 7701013275



**2304** rodamiento de Ø 28.0 mm  
kit fuelle transmisión izqda. l/cambio  
r.o. 7701468573



**1561**  
fuelle cremallera asistida  
r.o. 7700781095



**262**  
soporte silenciador trasero  
r.o. 7704001364



**2849**  
polea cigüeñal motor 1.9D (F8Q)  
r.o. 7700724749



**2850**  
polea cigüeñal motor 2.1D (J8S)  
r.o. 7700853470



**2851**  
polea cigüeñal motor 2.2dT (G8T)  
r.o. 7700858731

**SUSPENSION DELANTERA y SOPORTES de MOTOR (tracción delantera):**  
**motores 1.9D (F9Q), 2.2D (G9T), 2.5D (G9U y S8U), 2.8D (S9W) y 3.0D (ZD3)**

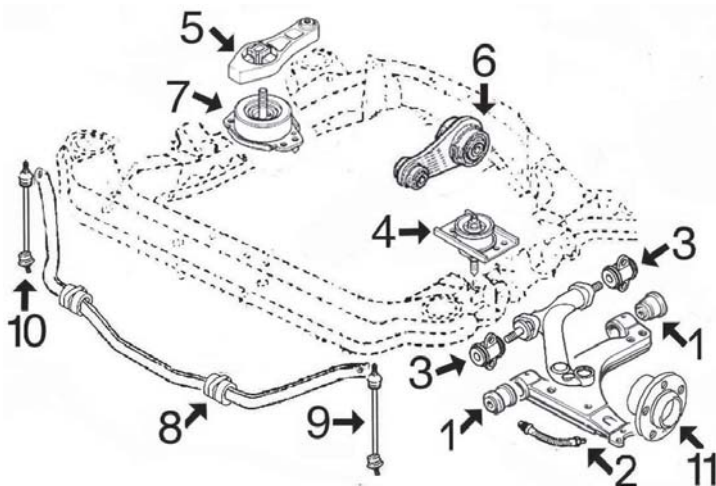

- 1- 4777 juego silentblocs trapecio inferior delantero
- 2- 96206 latiguillo freno delantero
- 3- 4778 silentbloc trapecio superior delantero
- 4- 4116 soporte motor izquierdo
- 5- 4775 tirante reacción derecho 1.9D
- 6- 4118 soporte motor trasero
- 7- 4835 soporte motor derecho 1.9DTi
- 4117 soporte motor derecho 2.5D (S8U) y 2.8D
- 4776 soporte motor derecho 2.2D y 2.5D (G9U)
- 8- 4404 goma barra estabilizadora
- 9- 4400 bieleta puntal izquierdo barra estabilizadora
- 10- 4399 bieleta puntal derecho barra estabilizadora
- 11- n/d buje rueda delantera de 15"
- n/d buje rueda delantera de 16"

**SUSPENSION TRASERA (modelos con tracción delantera)**

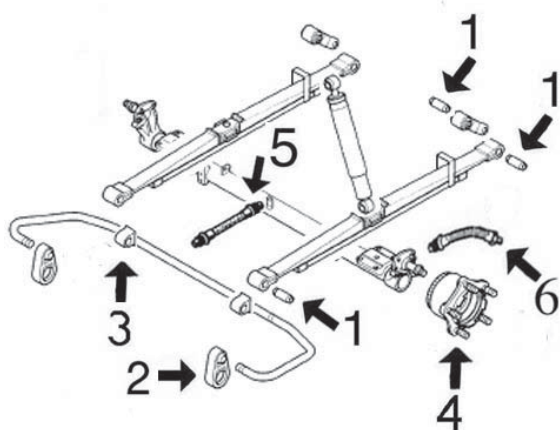

- 1- 4779 juego 3 silentblocs ballesta trasera
- 2- n/d puntal barra estabilizadora trasera
- 3- n/d goma barra estabilizadora trasera
- 4- n/d buje rueda trasera
- 5- 96207 latiguillo intermedio freno trasero
- 96208 latiguillo freno trasero de 355 mm
- 96209 latiguillo freno trasero de 270 mm

## RENAULT MASTER-II (1998- )



**4116**  
soporte motor izquierdo todos modelos  
r.o. 8200199149



**4117**  
soporte motor derecho 2.5D(S8U) y 2.8D  
r.o. 8200022595



**4118**  
soporte motor trasero todos modelos  
r.o. 7700308756



**4399**  
bieleta puntal **derecho** barra estabilizadora  
r.o. 7700309070



**4400**  
bieleta puntal **izquierdo** barra estabilizadora  
r.o. 7700309071



**4404**  
goma barra estabilizadora delantera  
r.o. 7700309154

**¡Nuevo!**



**4775**  
tirante reacción en soporte derecho 1.9DTi  
r.o. 8200073669

**¡Nuevo!**



**4776**  
soporte motor derecho 2.2D y 2.5D (G9U)  
r.o. 8200022596

**¡Nuevo!**



**4777**  
juego silentblocs trapecio inferior delant.  
r.o. 7700302122+7700302123

**¡Nuevo!**



**4778**  
silentbloc trapecio superior delantero  
r.o. 7700302115

**¡Nuevo!**



**4779**  
juego silentblocs ballesta trasera  
r.o. 8200024453+8200024454

**¡Nuevo!**



**4835**  
soporte motor derecho 1.9DTi  
r.o. 8200072229

**¡Nuevo!**



**96206**  
latiguillo freno delantero (582 mm)  
r.o. 5010422700

**¡Nuevo!**



**96207**  
latiguillo freno intermedio trasero (433 mm)  
r.o. 7700309823

**¡Nuevo!**



**96208**  
latiguillo freno trasero de 355 mm  
r.o. 8200086894













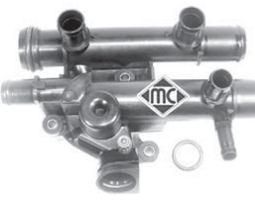





**¡Nuevo!**



**96209**  
latiguillo freno trasero de 270 mm  
r.o. 5010422009



## RENAULT MASTER-II (1998- )

<p><b>¡Nuevo!</b></p>  <p><b>3645</b> <span style="float: right;"><b>89°</b></span> caja con termostato completa 1.9D (89°) r.o. 8200074346</p>	<p><b>¡Nuevo!</b></p>  <p><b>3661</b> <span style="float: right;"><b>83°</b></span> caja con termostato completa 1.9D (83°) r.o. 8200074349</p>	<p><b>¡Nuevo!</b></p>  <p><b>3646</b> caja de termostato completa 2.2D-2.5D, <b>83°</b> r.o. 8200262237-8200262241-8200154296</p>
 <p><b>3563</b> tapón botella de expansión r.o. 7700805131</p>	 <p><b>3124</b> tubo de agua metálico 2.8HDi-Sofim S9W r.o. 7701044895</p>	<p><b>¡Nuevo!</b></p>  <p><b>3717</b> decantador completo 1.9 Diesel r.o.</p>
<p><b>¡Nuevo!</b></p>  <p><b>4455</b> <span style="float: right;"><b>6 canales</b></span> polea cigüeñal 1.9 Diesel r.o. 8200079183</p>	<p><b>¡Nuevo!</b></p>  <p><b>4666</b> <span style="float: right;"><b>7 canales</b></span> polea cigüeñal 1.9 Diesel r.o. 8200297937</p>	<p><b>¡Nuevo!</b></p>  <p><b>4463</b> polea cigüeñal 2.2/2.5 Diesel r.o. 8200213058</p>
<p><b>¡Nuevo!</b></p>  <p><b>4585</b> <span style="float: right;"><b>7 canales</b></span> polea cigüeñal 2.2/2.5 Diesel r.o. 8200207435</p>	<p><b>¡Nuevo!</b></p>  <p><b>4568</b> <span style="float: right;"><b>5+6 canales</b></span> polea cigüeñal 2.8 Diesel r.o. 0515.P3</p>	<p><b>¡Nuevo!</b></p>  <p><b>4728</b> <span style="float: right;"><b>sólida</b></span> polea alternador <b>5 canales</b> r.o.</p>
<p><b>¡Nuevo!</b></p>  <p><b>4729</b> <span style="float: right;"><b>sólida</b></span> polea alternador <b>6 canales</b> r.o.</p>	<p><b>¡Nuevo!</b></p>  <p><b>4947</b> <span style="float: right;"><b>desembragable</b></span> polea alternador <b>5 canales</b> r.o. 8200113636</p>	<p><b>¡Nuevo!</b></p>  <p><b>4948</b> <span style="float: right;"><b>desembragable</b></span> polea alternador <b>6 canales</b> r.o. 7700110616</p>
<p><b>¡Nuevo!</b></p>  <p><b>4912</b> <span style="float: right;"><b>Ø 61,00 mm</b></span> polea de alternador <b>de rueda libre</b> r.o.</p>	<p><b>¡Nuevo!</b></p>  <p><b>4913</b> <span style="float: right;"><b>Ø 53,30 mm</b></span> polea de alternador <b>de rueda libre</b> r.o.</p>	<p><b>¡Nuevo!</b></p>  <p><b>4914</b> <span style="float: right;"><b>Ø 55,40 mm</b></span> polea de alternador <b>de rueda libre</b> r.o.</p>
<p><b>¡Nuevo!</b></p>  <p><b>4994</b> polea árbol de levas 1.9DTi-DCi (F9Q) r.o. 7700866844-7700107401</p>		

## RENAULT MASTER-II (1998- )



**3617**  
tapón llenado aceite motor  
r.o. 8200096805

**¡Nuevo!**



**4724**  
varilla nivel aceite motor 2.2/2.5 Diesel  
r.o. 8200086256

**¡Nuevo!**



**4725**  
varilla nivel aceite motor 1.9D  
r.o. 8200138515



**1520**  
kit fuelle transmisión l/rueda (Ø 27/90 mm)  
r.o. 7701473176



**1225**  
kit fuelle transmisión l/rueda (Ø 30/98 mm)  
r.o. 7701472975



**2304** rodamiento de Ø 28.0 mm  
kit fuelle transmisión **izquierda** l/cambio  
(Ø exterior boca grande 114 mm)

**¡Nuevo!**



**1139** rodamiento de Ø 28.0 mm  
kit fuelle transmisión **izquierda** l/cambio  
(Ø exterior boca grande 105 mm)

**¡Nuevo!**



**1135**  
kit fuelle transmisión **derecha** l/cambio  
r.o. 7701470910



**1107**  
fuelle cremallera dirección (Ø 13/53 mm)  
r.o.



**1530**  
fuelle cremallera dirección (Ø 10/42 mm)  
r.o. 7701470361



**667**  
tapón cárter de aceite 1.9D  
r.o. 7703075210



**670**  
tapón cárter de aceite 2.2/ 2.5D  
r.o. 7903075033



**2722**  
soporte tubo de escape todos mods.  
r.o.

**¡Nuevo!**



**9095**  
mgto desvaporizador con válvula 1.9 Diesel  
r.o. 8200063371-8200136128

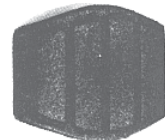

**417**  
cubrepedal freno y embrague  
r.o. 7700680836

# RENAULT MÉGANE-I - SCÉNIC-I (1996-2002)

## CANALIZACIONES DE AGUA:

MÉGANE-SCÉNIC

MODELOS hasta '98:

1.4 motor E7J  
1.6 motor K7M

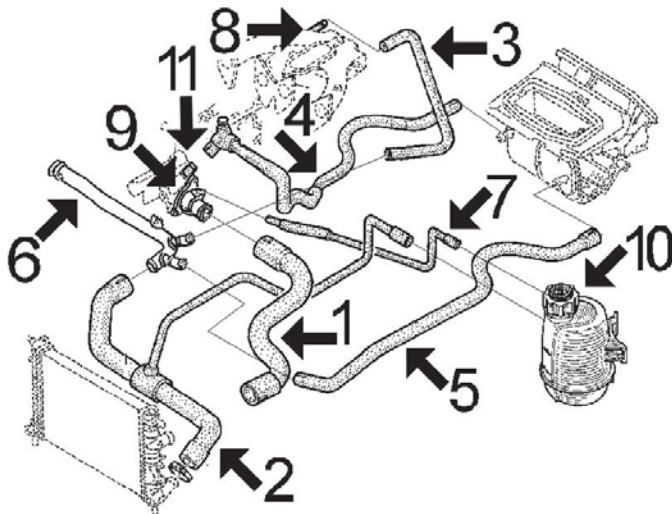

- 1- 8445 mgto superior radiador
- 2- 8447 mgto inferior radiador sin aire acondicionado  
8448 mgto inferior radiador con aire acondicionado
- 3- 8443 mgto de tubo metálico a colector, sólo 1.4
- 4- 8444 mgto de caja de termostato a calefactor
- 5- 8449 mgto de tubo metálico a calefactor
- 6- 3109 tubo de agua metálico
- 7- 8451 mgto de botella a tapa de termostato
- 8- 3010 boquilla en colector, sólo 1.4
- 9- 3119 tapa de termostato  
2404 junta de termostato
- 10- 3534 botella de expansión  
3514 tapón botella de expansión 1,20 bar (marrón)  
3525 tapón botella de expansión 1,40 bar (celeste)
- 11- 3148 boquilla metálica en cuerpo termostato

MÉGANE-SCÉNIC

MODELOS hasta '98:

2.0 gasolina motor F3R  
16v. motor F7R (sólo Mégane)  
1.9 Diesel F8Q

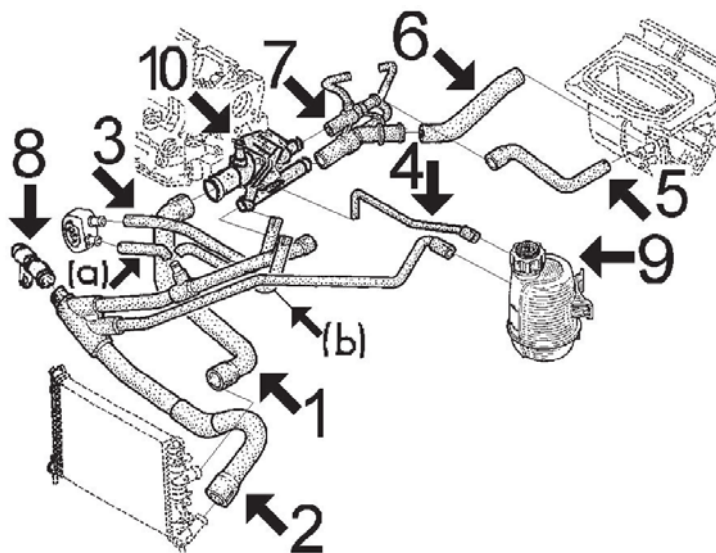

- 1- 8450 mgto superior radiador
  - 2- 8446 mgto inferior radiador (\*)
  - 3- 118 mgto de intercambiador a caja de termostato, sólo versiones con intercambiador en el filtro de aceite. Cortar de rollo MC-118 Ø 13x20 mm longitud 350 mm.
  - 4- 8451 mgto de botella a tapa de termostato
  - 5- 7660 mgto de calefactor a caja de termostato
  - 6- 8452 mgto de calefactor a caja de termostato (con purgador)
  - 7- n/d mgto intermedio multiconexión a caja de termostato y mgto de calefactor, sólo 2.0
  - 8- 3108 boquilla metálica entrada agua a bloque hasta '97 (desde '97 es de plástico)
  - 9- 3534 botella de expansión  
3514 tapón botella de expansión 1,20 bar (marrón)  
3525 tapón botella de expansión 1,40 bar (celeste)
  - 10- 3569 cuerpo completo con accesorios (con termostato)  
3624 cuerpo completo con accesorios (sin termostato)
- 8665 mgto desvaporizador 1.9 Diesel F8Q  
8666 mgto desvaporizador 1.9 Diesel F8Q  
8738 mgto desvaporizador 1.9 Diesel F9Q

(\*) nota: el mgto inferior de radiador se suministra conjuntamente con los mgto (a) y (b) para acoplar respectivamente según sea para la versión equipada con intercambiador (Diesel con aire acondicionado) o para la versión sin intercambiador (2.0 todos y Diesel sin aire acondicionado)



# RENAULT MÉGANE-I - SCÉNIC-I (1996-2002)

MÉGANE-SCÉNIC

MODELOS desde '98:

1.4/16v motor K4M  
1.6/16v motor K4J

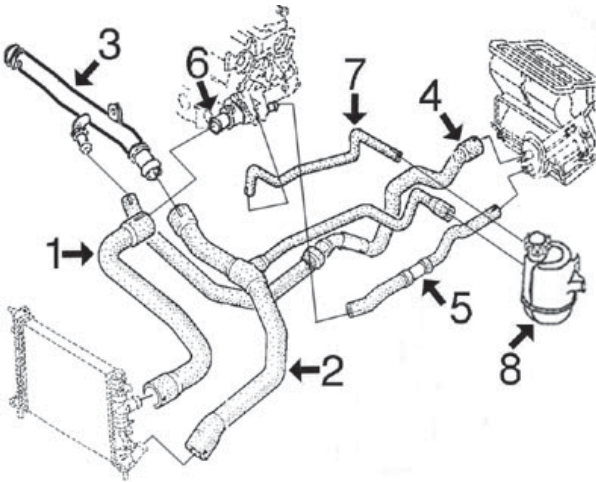

- 1- 8912 mgto superior radiador con aire acondicionado
- 8913 mgto superior radiador sin aire acondicionado
- 2- 8911 mgto inferior radiador
- 3- 3663 tubo de agua (plástico)
- 4- 8914 mgto de calefactor a tubo rígido (2 tramos)
- 5- 8915 mgto de calefactor a caja de termostato
- 6- 3119 tapa de termostato
- 3148 boquilla metálica en caja de termostato
- 7- 8916 mgto de botella a caja de termostato
- 8- 3534 botella de expansión
- 3563 tapón botella de expansión

8750 mgto desvaporizador

MÉGANE-SCÉNIC

MODELOS desde '98:

1.8/16v motor F4R

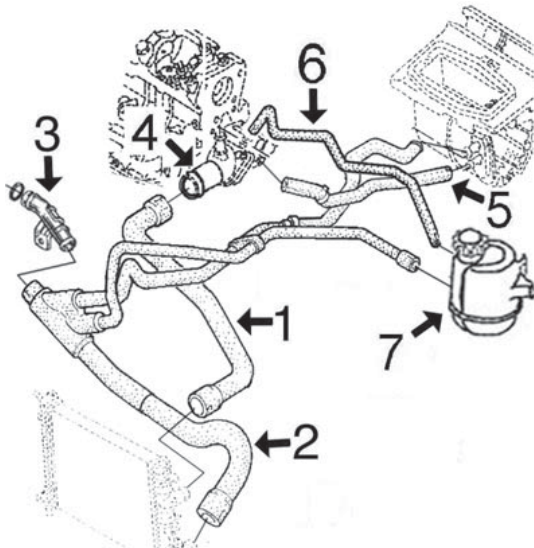

- 1- 8912 mgto superior radiador
- 2- 8917 mgto inferior radiador
- 3- 3662 boquilla plástico entrada agua a bloque
- 4- 3119 tapa de termostato
- 3148 boquilla metálica en caja de termostato
- 5- 8915 mgto de calefactor a caja de termostato
- 6- 8916 mgto de botella a caja de termostato
- 7- 3534 botella de expansión
- 3563 tapón botella de expansión

MÉGANE-SCÉNIC

MODELOS desde '98:

1.9 D/Dti/Dci motor F9Q

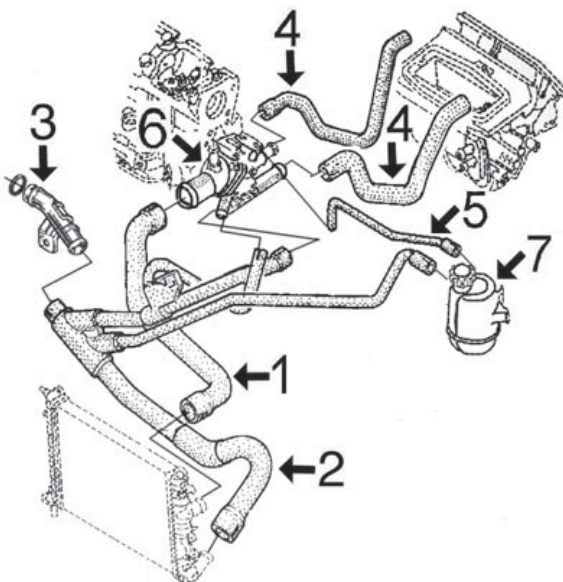



- 1- 8450 mgto superior radiador hasta 5/'00
- 8918 mgto superior radiador desde 5/'00
- 2- 8446 mgto inferior radiador hasta 11/'99
- 8919 mgto inferior radiador desde 11/'99 hasta 12/'00
- 8920 mgto inferior radiador desde 12/'00
- 3- 3662 boquilla plástico entrada agua a bloque
- 4- 8921 juego mgto de calefactor a caja de termostato
- 5- 8451 mgto de botella a caja de termostato
- 6- 3569 caja de termostato completa hasta 11/'99
- 3645 caja de termostato completa desde 11/'99 (89°)
- 3661 caja de termostato completa desde 11/'99 (83°)
- 7- 3534 botella de expansión
- 3563 tapón botella de expansión

9095 mgto desvaporizador con válvula



## RENAULT MÉGANE-I - SCÉNIC-I (1996-2002)

 <p><b>7660</b> mgto de calefactor a termostato 2.0 y D r.o. 7700830113-7700830101</p>	 <p><b>8443</b> mgto de tubo metálico a colector 1.4 r.o. 7700873500</p>	 <p><b>8444</b> mgto de termostato a calefactor 1.4-1.6 r.o. 7700829990</p>
 <p><b>8445</b> mgto superior radiador 1.4-1.6 r.o. 7700829986-7700829989</p>	 <p><b>8446</b> mgto inferior radiador 2.0 y Diesel r.o. 7700829999-7700830100</p>	 <p><b>8447</b> mgto inferior radiador 1.4-1.6 sin aire ac. r.o. 7700829988</p>
 <p><b>8448</b> mgto inferior radiador 1.4-1.6 con aire ac. r.o. 7700829987</p>	 <p><b>8449</b> mgto de tubo metálico a calefactor 1.4-1.6 r.o. 7700829993</p>	 <p><b>8450</b> mgto superior radiador 2.0 y Diesel r.o. 7700829998</p>
 <p><b>8451</b> mgto de botella a tapa de termostato 2.0 y D r.o. 7700829994</p>	 <p><b>8452</b> mgto de calefactor a termostato 2.0 y D r.o. 7700830114-7700830102</p>	 <p><b>8665</b> mgto desvaporizador 1.9 Diesel F8Q r.o.</p>
 <p><b>8666</b> mgto desvaporizador 1.9 Diesel F8Q r.o.</p>	 <p><b>8738</b> mgto desvaporizador 1.9 Diesel F9Q r.o.</p>	 <p><b>8750</b> mgto desvaporizador 1.4/16v-1.6/16v r.o.</p>
 <p><b>8911</b> mgto inferior radiador 1.4/16v-1.6/16v r.o.</p>	 <p><b>8912</b> mgto sup radiador 1.4/16v-1.6/16v aire ac. r.o.</p>	 <p><b>8913</b> mgto sup radiador 1.4/16v-1.6/16v sin a/a r.o.</p>
 <p><b>8914</b> mgto de calefactor a tubo 1.4/16v-1.6/16v r.o.</p>	 <p><b>8915</b> mgto calefactor a termostato 1.4/16v-1.6/16v r.o.</p>	 <p><b>8916</b> mgto de botella a caja termost 1.4-1.6/16v r.o.</p>

# RENAULT MÉGANE-I - SCÉNIC-I (1996-2002)

**iNuevo!**



**8917**  
mgto inferior radiador 1.8/16v  
r.o.

**iNuevo!**



**8918**  
mgto superior radiador 1.9D '98-'00  
r.o.

**iNuevo!**



**8919**  
mgto inferior radiador 1.9D '99-'00  
r.o.

**iNuevo!**



**8920**  
mgto inferior radiador 1.9D desde 12/'00-  
r.o.

**iNuevo!**



**8921**  
jog mgto calefactor 1.9D desde '98-  
r.o.

**iNuevo!**



**9095**  
mgto desvaporizador 1.9D desde '98-  
r.o.



**3010**  
boquilla metálica en colector 1.4  
r.o. 7705030338



**3108** con junta tórica  
boquilla entrada agua a bloque 2.0 y Diesel  
hatsa '97, r.o. 7700866560



**3109** con junta tórica  
tubo de agua metálico 1.4-1.6 (8 válvulas)  
r.o. 7700870330+7703065311



**3119**  
tapa de termostato 1.4-1.6  
r.o. 7700866387



**3148**  
boquilla metálica en cuerpo termostato  
r.o. no hay despiece



**3514** 1,2 bar-cápsula marrón  
tapón botella de expansión hasta '98  
r.o. 7700805031



**3525** 1,4 bar-cápsula celeste  
tapón de botella de expansión hasta '99  
r.o. 7700805032



**3534**  
botella de expansión  
r.o. 7701468746



**3563**  
tapón botella de expansión desde '99  
r.o. 7700805131



**3569** CON TERMOSTATO  
cuerpo de termost. completo con accesorios  
1.9D-DTi hasta '99, r.o. 7701474249



**3624** SIN TERMOSTATO  
cuerpo de termost. completo con accesorios  
1.9D-DTi hasta '99, 8200065392+8200065394

**iNuevo!**

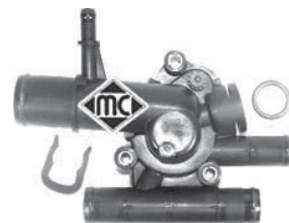

**3645**  
caja de termostato completa desde '99 (89°)  
r.o. 8200074346

**iNuevo!**

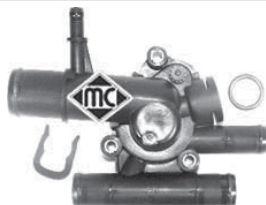

**3661**  
caja de termostato completa desde '99 (83°)  
r.o.

**iNuevo!**



**3662**  
boquilla entrada agua a bloque 1.8-2.0-1.9D  
desde '97, r.o. 7700873948

**iNuevo!**



**3663**  
tubo de agua 1.4/16v-1.6/16v con junta  
r.o. 8200134513+7703065311

**RENAULT MÉGANE-I - SCÉNIC-I (1996-2002)**

**¡Nuevo!**



**3714**

decantador completo con junta 1.9D-F8Q y 2.0 gasolina, r.o.

**¡Nuevo!**



**3717**

decantador completo con junta 1.9D-F9Q r.o.



**2404**

junta de termostato 1.4-1.6 r.o.7700741923



**2728**

Ø 12 mm

tapón obturador boquilla tubo metálico r.o.7703074331

# RENAULT MÉGANE-I - SCÉNIC-I (1996-2002)

## SUSPENSION DELANTERA y SOPORTES DE MOTOR hasta modelo '98:

MÉGANE-SCÉNIC

MODELOS hasta '98:

1.4 motor E7J de 8 válvulas  
1.6 motor K7M de 8 válvulas

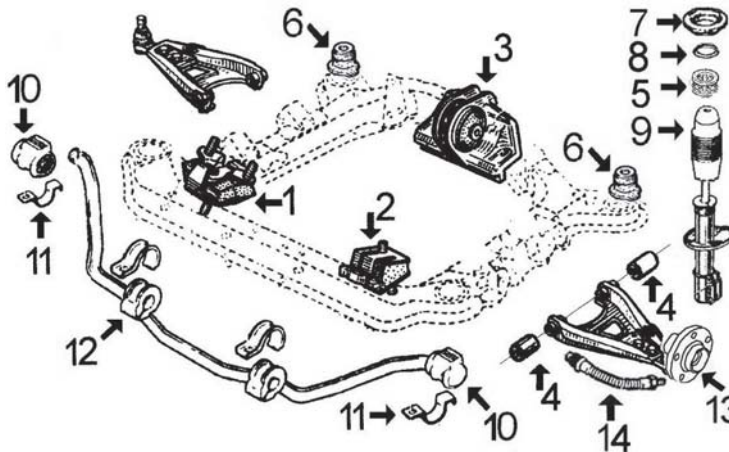

- 1- 705 soporte motor derecho
- 2- 706 soporte motor izquierdo
- 3- 707 soporte motor trasero
- 4- 984 silentbloc trapecio delantero
- 5- n/d tope de goma amortiguador delantero
- 6- 4316 silentbloc sub-chasis delantero
- 7- 4151 soporte amortiguador delantero
- 8- 4178 rodamiento soporte amortiguador
- 9- 4173 capuchón amortiguador
- 10- 867 goma puntal barra estabilizadora
- 11- 827 abrazadera puntal barra estabilizadora
- 12- 868 goma central barra estabilizadora
- 13- 90020 buje rueda delantera
- 14- 96104 latiguillo freno delantero (420 mm)

MÉGANE-SCÉNIC

MODELOS hasta '98:

2.0 gasolina F3R de 8 válvulas  
2.0-16v. motor F7R (sólo Mégane)  
1.9D-dT motor F8Q

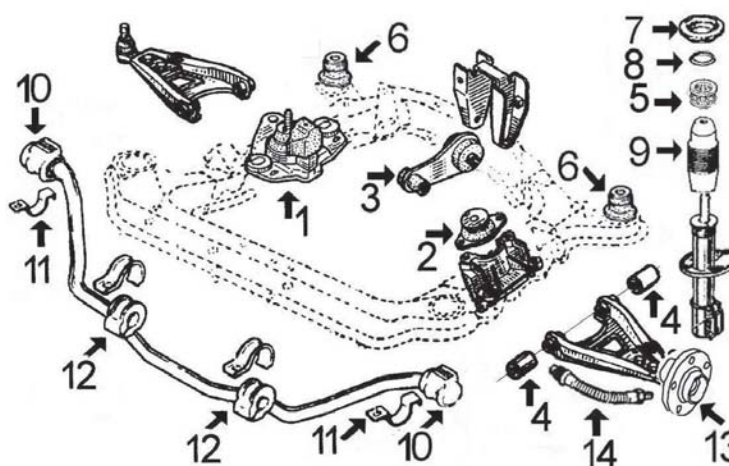

- 1- 2875 soporte motor derecho
- 2- 973 soporte motor izquierdo, cambio manual
- 4286 soporte motor izquierdo, cambio automático
- 3- 2881 soporte motor trasero 1.9 Diesel (hidráulico)
- 999 soporte motor trasero 2.0 y 16v cambio manual
- 4896 soporte motor trasero 1.9D y 2.0 automáticos
- 4- 984 silentbloc trapecio delantero salvo 16v
- 2832 silentbloc trapecio delantero 16v
- 5- n/d tope de goma amortiguador delantero
- 6- 4316 silentbloc sub-chasis delantero
- 7- 4151 soporte amortiguador delantero
- 8- 4178 rodamiento soporte amortiguador
- 9- 4173 capuchón amortiguador
- 10- 867 goma puntal para barra estabiliz. de Ø 23 mm
- 2483 goma puntal para barra estabiliz. de Ø 24 mm
- 11- 827 abrazadera puntal barra estabilizadora
- 12- 868 goma central para barra estabiliz. de Ø 23 mm
- 4167 goma central para barra estabiliz. de Ø 24 mm
- 13- 90020 buje rueda delantera
- 14- 96104 latiguillo freno delantero (420 mm)



# RENAULT MÉGANE-I - SCÉNIC-I (1996-2002)

## SUSPENSION DELANTERA y SOPORTES DE MOTOR desde modelo '98:

MÉGANE (NO Scénic)

MODELOS desde '98:

1.4-16v motor K4J  
1.6-16v motor K4M  
2.0-16v motor F4R  
1.9D/Dti/Dci motor F9Q

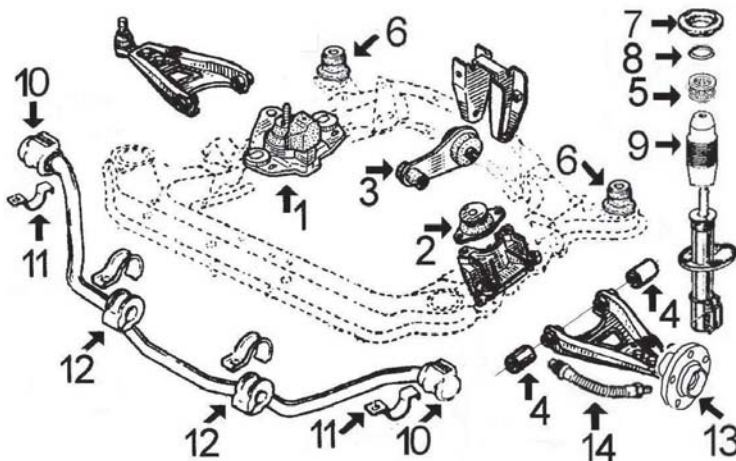

- 1- 4101 soporte motor derecho 1.4-1.6 y 2.0/16v
- 2875 soporte motor derecho 1.9 D/DTi/Dci hasta 3/'00
- 4608 soporte motor derecho 1.9 D/DTi/Dci desde 3/'00
- 2- 973 soporte motor izquierdo, cambio manual
- 4286 soporte motor izquierdo, cambio automático
- 3- 4093 soporte motor trasero 1.4-1.6 hasta 11/'99
- 4073 soporte motor trasero 1.4-1.6 desde 11/'99
- 999 soporte motor tras. 1.9 Dti/Dci y 2.0/16v hasta 3/'00
- 4102 soporte motor tras. 1.9 Dti/Dci y 2.0/16v desde 3/'00
- 4896 soporte motor trasero 1.9D y 2.0 cambio automático
- 4- 984 silentbloc trapecio delantero salvo 2.0/16v
- 2832 silentbloc trapecio delantero 2.0/16v
- 5- n/d tope de goma amortiguador delantero
- 6- 4316 silentbloc sub-chasis delantero
- 7- 4151 soporte amortiguador delantero
- 8- 4178 rodamiento soporte amortiguador
- 9- 4173 capuchón amortiguador delantero
- 10- 4103 goma puntal para barra estabilizadora de Ø 23 mm
- 4113 goma puntal para barra estabilizadora de Ø 24 mm
- 11- 827 abrazadera puntal barra estabilizadora
- 12- 868 goma central para barra estabilizadora de Ø 23 mm
- 4167 goma central para barra estabilizadora de Ø 24 mm
- 13- 90020 buje rueda delantera
- 14- 96104 latiguillo freno delantero (420 mm)

SCÉNIC (NO Mégane)

MODELOS desde '98:

1.4-16v motor K4J  
1.6-16v motor K4M  
1.8-16v motor F4P  
2.0-16v motor F4R  
1.9D/Dti/Dci motor F9Q

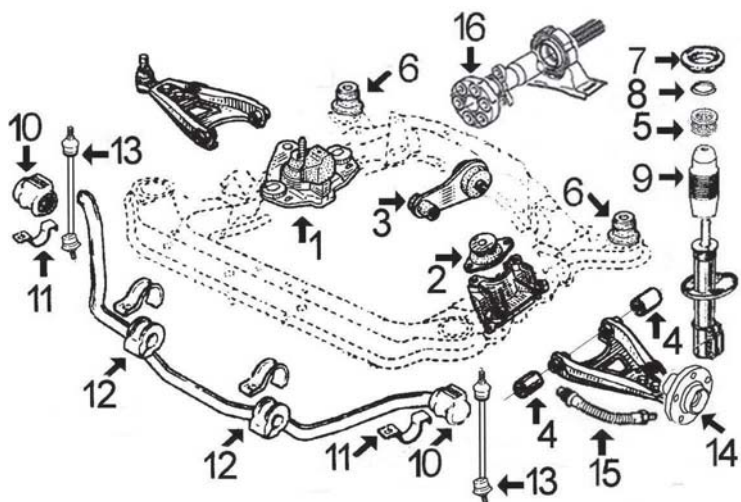

- 1- 4101 soporte motor derecho 2x4 1.4-1.6 y 2.0/16v
- 2875 soporte motor dcho. 2x4 1.9 D/Dti/Dci hasta 3/'00
- 4608 soporte motor dcho. 2x4 1.9 D/Dti/Dci desde 3/'00
- 4101 soporte motor derecho 4x4 todos tipos
- 2- 973 soporte motor izquierdo, cambio manual
- 4286 soporte motor izquierdo, cambio automático
- 3- 4102 soporte motor trasero todos modelos 2x4 cambio manual
- 4093 soporte motor trasero 1.6 cambio automático
- 4222 soporte motor trasero todos modelos 4x4
- 4896 soporte motor trasero 1.9D y 2.0 automáticos
- 4- 984 silentbloc trapecio delantero 2x4 salvo 2.0/16v
- 2832 silentbloc trapecio delantero 2x4 2.0/16v
- 4274 silentbloc trapecio delantero todos modelos 4x4
- 5- n/d tope de goma amortiguador delantero
- 6- 4316 silentbloc sub-chasis delantero
- 7- 4151 soporte amortiguador delantero
- 8- 4178 rodamiento soporte amortiguador
- 9- 4173 capuchón amortiguador delantero 2x4
- n/d capuchón amortiguador delantero 4x4
- 10- 4103 goma puntal barra estabilizadora 2x4 (Ø 23 mm)
- 4113 goma puntal barra estabilizadora 2x4 (Ø 24,5 mm)
- 11- 827 abrazadera puntal barra estabilizadora
- 12- 4220 goma central barra estabilizadora 2x4
- 4167 goma central barra estabilizadora 4x4
- 13- 4221 bieleta puntal barra estabilizadora todos mods. 4x4
- 14- 90020 buje rueda delantera 1.4-1.6 hasta '99
- 90068 buje rueda delantera 1.6 desde '99
- 90067 buje rueda delantera 2.0 y 1.9dT
- 15- 96104 latiguillo freno delantero (420 mm)
- 16- 4417 flector de transmisión 4x4

SUSPENSIÓN TRASERA todos modelos MÉGANE y SCÉNIC salvo 4x4:

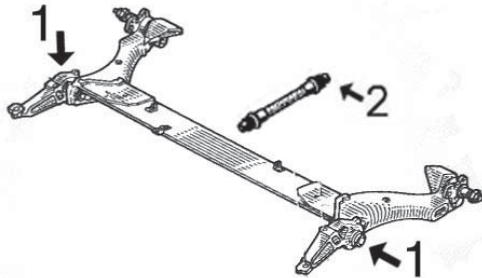

- 1- 2870 silentbloc interior articulación MÉGANE
- 2904 silentbloc exterior articulación MÉGANE
- 4262 silentbloc articulación SCÉNIC
- 2- 96155 latiguillo freno trasero (295 mm)

SUSPENSIÓN TRASERA SCÉNIC 4x4:

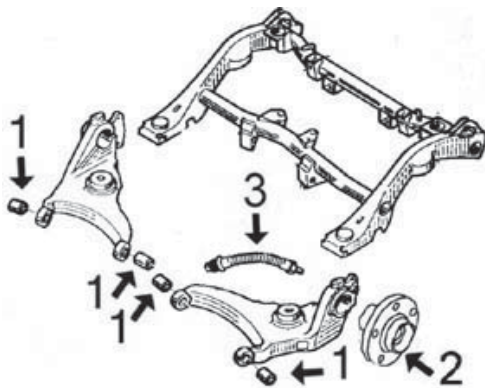

- 1- 4219 silentbloc trapecio trasero SCÉNIC 4x4
- 2- 90527 buje rueda trasera con rodamiento
- 3- n/d latiguillo freno trasero

## RENAULT MÉGANE-I - SCÉNIC-I (1996-2002)



**705**  
soporte motor derecho 1.4-1.6  
r.o. 7700785949



**706**  
soporte motor izquierdo 1.4-1.6  
r.o. 7700801543



**707**  
soporte motor trasero 1.4-1.6  
r.o. 7700804163



**827**  
abrazadera goma puntal barra estabilizadora  
r.o. 7700784169



**867**  
goma puntal barra estabilizadora 1.4-1.6  
Ø 23 mm, r.o. 7700784170



**868**  
goma central barra estabilizadora 1.4-1.6  
r.o. 7700785788



**973**  
soporte motor izquierdo, cambio manual  
r.o. 7700788318



**984**  
silentbloc trapecio delantero 2x4, salvo 16v  
r.o. 7700840741 (7700789478)



**999**  
soporte motor trasero 2.0 y 2.0-16v.  
r.o. 7700849715



**2483**  
goma puntal barra estabilizadora Ø 24 mm  
r.o. 7700784171



**2832**  
silentbloc trapecio delantero 2.0-16v  
r.o. 7700789477



**2870** 43x76.5x28x28  
silentbloc interior articulación suspensión  
trasera



**2875** hidráulico  
soporte motor derecho 1.9 Diesel y 2.0  
r.o. 7700832256



**2881** hidráulico  
soporte motor trasero 1.9 Diesel  
r.o. 7700413614



**2904** 43x76.5x35x35  
silentbloc exterior articulación suspensión  
trasera



**4073**  
soporte motor trasero 1.4-1.6 desde '98  
r.o. 8200171178 (7700437854)



**4093**  
soporte motor trasero 1.4-1.6 desde '99  
r.o. 7700832264 (7700315024)



**4101**  
soporte motor derecho 1.4-1.6 desde '98  
r.o. 7700437391



**4102**  
soporte motor trasero 1.9 DTi desde '98  
r.o. 8200148388 (7700432031)



**4103**  
goma puntal barra estabiliz. desde '98 Ø 23  
r.o. 8200150768



**4113**  
goma puntal barra estab. desde '98, Ø 24  
r.o. 8200150759



# RENAULT MÉGANE-I - SCÉNIC-I (1996-2002)



**4151**  
soporte amortiguador delantero  
r.o. 7700835254



**4167**  
goma central barra estabilizadora Scénic 4x4  
r.o. 7700835929



**4173**  
capuchón amortiguador delantero salvo  
4x4, r.o. 7700776743



**4178**  
rodamiento soporte amortiguador  
r.o. 7700797666



**4219**  
silentbloc trapecio trasero Scénic 4x4  
r.o. 7700436707



**4220**  
goma central barra estabilizadora Scénic  
2x4, r.o. 7700428738



**4221**  
bieleta puntal barra estabiliz. Scénic 4x4  
r.o. 7700437136



**4222**  
soporte motor trasero Scénic 4x4  
r.o. 8200094942 + 7700436395



**4262**  
silentbloc articulación suspensión trasera  
Scénic, r.o. 7700762844-7700762843



**4274**  
silentbloc trapecio delantero Scénic 4x4  
r.o. 7700437028

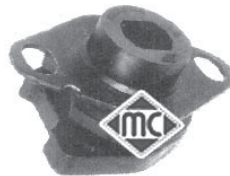

**4286**  
soporte motor izquierdo, cambio automático  
r.o. 7700427286



**4316**  
silentbloc sub-chasis delantero  
r.o. 7700779772



**4417** Ø 128 mm  
flector de transmisión Scénic 4 x 4  
r.o. no hay despiece, sólo árbol completo

**¡Nuevo!**



**4608**  
soporte motor derecho 1.9D desde '00  
r.o. 8200267624

**¡Nuevo!**



**4896**  
soporte motor trasero 1.9D y 2.0 cambio  
automático, r.o. 7700414827



**90020**  
bujes rueda delantera salvo Scénic 2.0 y  
y Scénic 1.9dT hasta '99, r.o. 7700768319

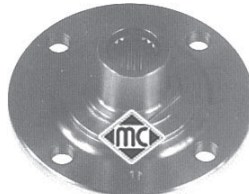

**90067**  
bujes rueda delantera Scénic 1.9dT y 2.0  
hasta '99, r.o. 7700830220



**90068**  
bujes rueda delantera Scénic 1.6-1.9dT y 2.0  
desde '99, r.o. 7700415121



**90527**  
bujes rueda trasera Scénic  
r.o. 7701204692



**96104**  
latiguillo freno delantero 2x4 (420 mm)  
r.o. 7700840390



**96155**  
latiguillo freno trasero 2x4 (295 mm)  
r.o. 7700834863







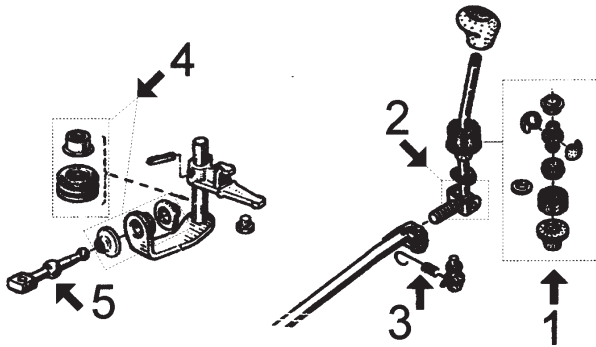









# RENAULT MÉGANE-I - SCÉNIC-I (1996-2002)

## ARTICULACIONES PALANCA DE CAMBIO

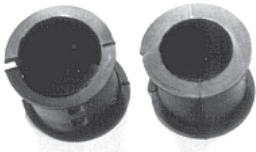

- 1- 516 juego casquillos rótula palanca
- 2- 2882 casquillo eje pasador inferior de palanca
- 3- n/d muelle retorno palanca
- 4- 908 juego casquillos y retén selector
- 5- 2883 palanca del selector hasta '98
- 4287 palanca del selector desde '98

 <p><b>2817</b> serreta pedal de embrague completa r.o. 7701470150</p>	 <p><b>516</b> juego casquillos palanca de cambio r.o. 7700464111</p>	 <p><b>908</b> juego casquillos-retén extremo palanca de cambio, r.o. 7700679960+7703087163</p>
 <p><b>2882</b> casquillo eje inferior palanca de cambio r.o. 7700732903</p>	 <p><b>2883</b> bieleta selector de velocidades completa r.o. 7700875584+7700872205+7700743133</p>	 <p><b>4287</b> bieleta selector de velocidades desde '98 r.o. 7700102476</p>
 <p><b>4297</b> horquilla embrague 1.9D hasta '98 (F8Q) r.o. 7700715851</p>	 <p><b>4677</b> horquilla embrague 1.9D desde '98 (F9Q) con rótula, r.o. 7700861585</p>	 <p><b>4641</b> juego tapas arboles de levas 1.4-1.6/16v r.o. 7700106271+7700274026</p>
 <p><b>1350</b> fuelle cremallera manual r.o. 7701469497</p>	 <p><b>444</b> casquillo cremallera manual r.o. 7704000926</p>	 <p><b>2316</b> juego gomas sujeción cremallera asistida r.o. 7700778304+7700662571</p>
 <p><b>1558</b> fuelle cremallera asistida SMI r.o. 7701469496</p>	 <p><b>1356</b> fuelle cremallera asistida TRW r.o. 6000025546-7701469497</p>	 <p><b>1555</b> kit rep. transmisión l/rueda 1.4-1.6 y 1.9D hasta '98, r.o.</p>

# RENAULT MÉGANE-I - SCÉNIC-I (1996-2002)



**1432**  
kit rep. transmisión l/rueda 2.0  
r.o.



**1520**  
kit rep. transmisión l/rueda 2.0-16v  
r.o.



**1517**  
kit rep. transmisión l/rda todos desde '98  
r.o. 7701469021

**¡Nuevo!**



**1051**  
kit rep. transmisión l/rueda 2.0 (Ø 28-78 mm)  
r.o. 7701469414



**1537** rodamiento de Ø 25,8 mm  
kit rep. transm. izqda. l/cambio (salvo 16v)  
hasta '98, r.o.



**2304** rodamiento de Ø 28,0 mm  
kit rep. transm. izqda. l/cbo 16v y todos  
desde '98, r.o. 7701470566



**1559**  
kit rep. transm. derecha lado cambio  
r.o. 7701471522

**¡Nuevo!**



**1128**  
kit rep. transm. derecha lado cambio  
r.o. 7701469389

**¡Nuevo!**



**4725**  
varilla nivel aceite 1.9D desde '98  
r.o.



**3617**  
tapón llenado aceite 1.9 Diesel desde '98  
r.o. 7700110720



**3619**  
tapón llenado aceite 1.4/16v-1.6/16v  
desde '98, r.o. 7700111741

**¡Nuevo!**



**4465**  
polea cigueñal 1.4/16v-1.6/16v  
r.o. 8200313231

**¡Nuevo!**



**4774**  
polea cigueñal 1.8/16v-2.0/16v  
r.o. 8200386453



**¡Nuevo!**



**4577**  
polea cigueñal 2.0/8v (F3R)  
r.o. 7700109260

**¡Nuevo!**



**4611**  
polea cigueñal 2.0/16v  
r.o. 8200297935

**¡Nuevo!**



**4736**  
polea cigueñal 2.0/16v  
r.o. 8200386460



**4162**  
polea cigueñal 1.5Dci  
r.o. 8200185800

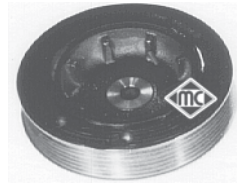





















**2849**  
polea de cigueñal 1.9 Diesel (F8Q) 6 canales  
r.o. 7700112999(7700724249)

**¡Nuevo!**



**4455**  
polea cigueñal 1.9Dti (F9Q)  
r.o. 7700115766

## RENAULT MÉGANE-I - SCÉNIC-I (1996-2002)

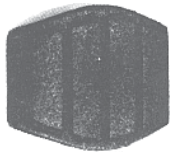





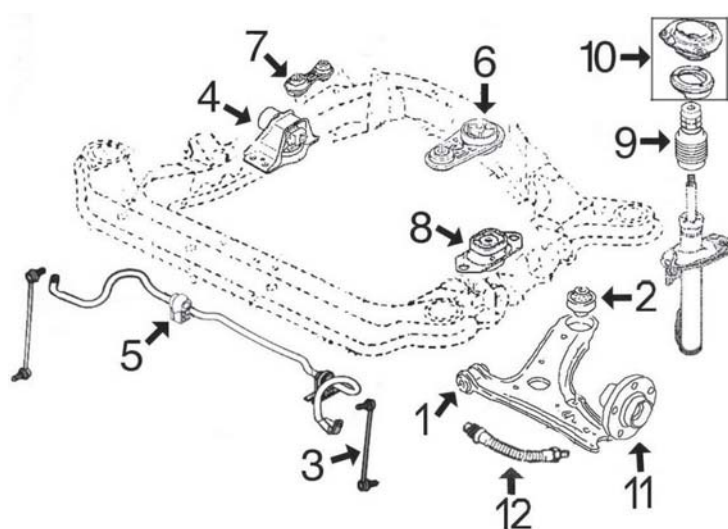



<p><b>¡Nuevo!</b></p>  <p><b>4664</b> polea cigüeñal 1.9TurboD (F8Q) r.o. 7700856673</p>	 <p><b>4163</b> polea cigüeñal 1.9Dti/Dci (F9Q) r.o. 7700115309</p>	<p><b>¡Nuevo!</b></p>  <p><b>4666</b> polea cigüeñal 1.9Dti/Dci (F9Q) r.o. 8200297937</p>
<p><b>¡Nuevo!</b></p>  <p><b>4728</b> <span style="float: right;"><b>sólida</b></span> polea alternador 1.5D-1.9D 5 canales r.o.</p>	<p><b>¡Nuevo!</b></p>  <p><b>4729</b> <span style="float: right;"><b>sólida</b></span> polea alternador 1.4/16v-1.6/16v 6 canales r.o.</p>	<p><b>¡Nuevo!</b></p>  <p><b>4642</b> juego juntas en tubo entrada Turbo 1.5Dci r.o. monta en 8200404193</p>
<p><b>¡Nuevo!</b></p>  <p><b>4947</b> <span style="float: right;"><b>desembragable</b></span> polea alternador 5 canales r.o. 8200113636</p>	<p><b>¡Nuevo!</b></p>  <p><b>4948</b> <span style="float: right;"><b>desembragable</b></span> polea alternador 6 canales r.o. 7700110616</p>	<p><b>¡Nuevo!</b></p>  <p><b>4994</b> polea árbol de levas 1.9DTi-DCi (F9Q) r.o. 7700866844-7700107401</p>
<p><b>¡Nuevo!</b></p>  <p><b>4912</b> <span style="float: right;"><b>Ø 61,00 mm</b></span> polea de alternador de rueda libre r.o.</p>	<p><b>¡Nuevo!</b></p>  <p><b>4913</b> <span style="float: right;"><b>Ø 53,30 mm</b></span> polea de alternador de rueda libre r.o.</p>	<p><b>¡Nuevo!</b></p>  <p><b>4914</b> <span style="float: right;"><b>Ø 55,40 mm</b></span> polea de alternador de rueda libre r.o.</p>
 <p><b>4291</b> soporte delantero tubo de escape r.o. 7700412282</p>	 <p><b>2721</b> <span style="float: right;"><b>silicona azul</b></span> soporte delantero tubo de escape r.o. 7700849696-7700846928</p>	 <p><b>2722</b> soporte silenciador trasero r.o. 7700836095-7700849461</p>
 <p><b>4218</b> soporte silenciador trasero Scénic 4x4 r.o. 7700434978</p>	 <p><b>748</b> collarín empalme tubo de escape 1.4-1.6 r.o.</p>	 <p><b>2025</b> arandela tapón cárter con retén de goma r.o.</p>
 <p><b>667</b> tapón cárter de aceite 1.4-1.6 r.o. 7703075210</p>	 <p><b>670</b> tapón cárter de aceite 2.0-16v y Diesel r.o. 7903075033</p>	 <p><b>417</b> cubrepedal freno y embrague r.o. 7700832177</p>

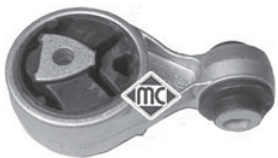

SUSPENSION DELANTERA y SOPORTES de MOTOR:











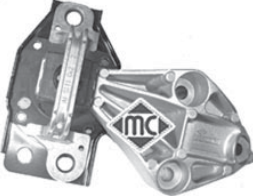
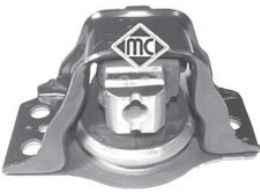



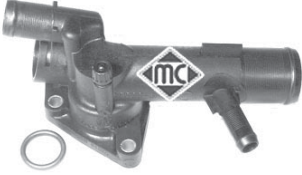
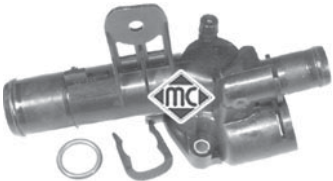

- 1- 4634 silentbloc anterior trapecio delantero
- 2- 4635 silentbloc posterior trapecio delantero
- 3- 4628 bieleta puntal barra estabilizadora
- 4- 4638 soporte motor derecho 1.5Dci hasta 9/'03
- 4638 soporte motor derecho 1.9Dci
- 4638 soporte motor derecho 2.0/16v
- 5- 4626 goma barra estabilizadora
- 6- 4629 soporte motor trasero 1.5Dci-105cv
- 4629 soporte motor trasero 1.9Dci y 2.0/16v
- 4631 soporte motor trasero 1.5Dci-80cv-100cv
- 4632 soporte motor trasero 1.4/16v-1.6/16v
- 7- 4630 bieleta tirante de reacción 1.9Dci y 2.0/16v
- 4627 bieleta tirante de reacción 1.5Dci - 2.0Dci
- 8- 4624 soporte motor izquierdo 1.5Dci hasta 9/'03
- 4625 soporte motor izquierdo 1.5Dci desde 9/'03
- 4624 soporte motor izquierdo 1.9Dci y 2.0/16v
- 4625 soporte motor izquierdo 1.4/16v-1.6/16v
- 9- 4682 capuchón amortiguador delantero
- 10- 4633 soporte amortiguador completo con rodamiento
- 11- n/d buje rueda delantera
- 12- 96203 latiguillo freno delantero

<p><b>iNuevo!</b></p>  <p><b>4624</b> soporte motor izquierdo 1.9D-1.5D-2.0/16v r.o.</p>	<p><b>iNuevo!</b></p>  <p><b>4625</b> soporte motor izquierdo 1.4/16v-1.6/16v r.o.</p>	<p><b>iNuevo!</b></p>  <p><b>4626</b> goma barra estabilizadora r.o.7701056678</p>
<p><b>iNuevo!</b></p>  <p><b>4627</b> bieleta tirante reacción en soporte derecho 1.5Dci, r.o.</p>	<p><b>iNuevo!</b></p>  <p><b>4628</b> bieleta puntal barra estabilizadora r.o.8200166159</p>	<p><b>iNuevo!</b></p>  <p><b>4629</b> soporte motor trasero 1.9D-1.5D-2.0/16v r.o.</p>
<p><b>iNuevo!</b></p>  <p><b>4630</b> bieleta tirante reacción en soporte derecho 1.9D-2.0/16v, r.o.</p>	<p><b>iNuevo!</b></p>  <p><b>4631</b> soporte motor trasero 1.5D r.o.</p>	<p><b>iNuevo!</b></p>  <p><b>4632</b> soporte motor trasero 1.4/16v-1.6/16v r.o.</p>
<p><b>iNuevo!</b></p>  <p><b>4633</b> soporte amortiguador delantero completo con rodamiento, r.o.7701208891-8200222463</p>	<p><b>iNuevo!</b></p>  <p><b>4634</b> silentbloc anterior trapecio delantero r.o.</p>	<p><b>iNuevo!</b></p>  <p><b>4635</b> silentbloc posterior trapecio delantero r.o.</p>



## RENAULT MEGANE II - SCENIC II (2002-)

<p><b>¡Nuevo!</b></p>  <p><b>4636</b> soporte motor derecho 1.4/16v-1.6/16v r.o.8200014931</p>	<p><b>¡Nuevo!</b></p>  <p><b>4637</b> soporte motor derecho 1.5Dci 6 velocidades r.o.8200325283</p>	<p><b>¡Nuevo!</b></p>  <p><b>4638</b> soporte motor derecho 1.5Dci, 1.9Dci y 2.0/16v,r.o.8200549046-8200592642</p>
<p><b>¡Nuevo!</b></p>  <p><b>4682</b> capuchón amortiguador delantero r.o.8200040073</p>	<p><b>¡Nuevo!</b></p>  <p><b>96203</b> latiguillo freno delantero (457 mm) r.o.8200333851</p>	
<p><b>¡Nuevo!</b></p>  <p><b>3714</b> decantador completo 2.0 gasolina r.o.</p>	<p><b>¡Nuevo!</b></p>  <p><b>3717</b> decantador completo 1.9Diesel r.o.</p>	
<p><b>¡Nuevo!</b></p>  <p><b>3645</b> caja de termostato completa 1.9D (89°) r.o.8200074346</p>	<p><b>¡Nuevo!</b></p>  <p><b>3661</b> caja de termostato completa 1.9D (83°) r.o.8200074349</p>	<p><b>¡Nuevo!</b></p>  <p><b>3670</b> caja de termostato completa 1.5D hasta 11/03,r.o.8200374994</p>
<p><b>¡Nuevo!</b></p>  <p><b>3679</b> caja de termostato completa 1.5D desde 11/03,r.o.8200267349</p>	<p><b>¡Nuevo!</b></p>  <p><b>3662</b> tubo entrada agua a bloque 1.9D-2.0/16v r.o.7700873948</p>	<p><b>¡Nuevo!</b></p>  <p><b>3663</b> tubo de agua 1.4/16v-1.6/16v r.o.8200134513</p>
<p><b>¡Nuevo!</b></p>  <p><b>3678</b> botella de expansión r.o.7701474499</p>	<p><b>¡Nuevo!</b></p>  <p><b>3563</b> tapón botella de expansión r.o.7700805131</p>	
<p><b>¡Nuevo!</b></p>  <p><b>3119</b> tapa de termostato 1.4/16v-1.6/16v r.o.7700866387</p>	<p><b>¡Nuevo!</b></p>  <p><b>3148</b> boquilla en caja termostato 2.0/16v r.o.7700104134</p>	<p><b>¡Nuevo!</b></p>  <p><b>3187</b> tubo de agua 1.5D hasta 11/03 r.o.8200089768</p>

## RENAULT MEGANE II - SCENIC II (2002-)



**1432**  
kit rep. transmisión l/rueda  
r.o.



**1130**  
kit rep. transmisión lado cambio  
r.o.

**¡Nuevo!**



**4725**  
varilla nivel aceite 1.9D  
r.o.



**3617**  
tapón llenado aceite 1.9D  
r.o. 8200096805



**3619**  
tapón llenado aceite 1.4/16v-1.6/16v  
r.o. 7700111741

**¡Nuevo!**



**3680**  
mgto desvaporizador con válvula 1.5D  
r.o. 8200147551

**¡Nuevo!**



**9095**  
mgto desvaporizador con válvula 1.9D  
r.o.

**¡Nuevo!**



**4642**  
juego juntas tubo entrada Turbo 1.5D  
r.o.

**¡Nuevo!**



**4641**  
juego tapas en culata (árboles de levas)  
r.o. 7700106271+7700274026

**¡Nuevo!**



**1136**  
fuelle cremallera dirección  
r.o.

**¡Nuevo!**



**4455**  
polea cigüeñal 1.9D  
r.o. 7700115766

**¡Nuevo!**



**4666**  
polea cigüeñal 1.9D  
r.o. 8200297937

**¡Nuevo!**



**4734**  
polea cigüeñal 1.9D  
r.o. 8200457775



**4163**  
polea cigüeñal 1.9D  
r.o. 7700115309



**4162**  
polea cigüeñal 1.5D hasta 11/03  
r.o. 8200051194

**¡Nuevo!**



**4735**  
polea cigüeñal 1.5D desde 11/03  
r.o. 8200477938

**¡Nuevo!**

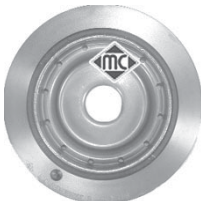

**4465**  
polea cigüeñal 1.4/16v-1.6/16v  
r.o. 8200313231

**¡Nuevo!**



















**4464**  
polea cigüeñal 2.0/16v  
r.o. 8200276838

**¡Nuevo!**



**4611**  
polea cigüeñal 2.0/16v  
r.o. 8200297935

## RENAULT MEGANE II - SCENIC II (2002-)

<p><b>¡Nuevo!</b></p>  <p><b>4736</b> polea cigueñal 2.0/16v r.o. 8200386460</p>	<p><b>¡Nuevo!</b></p>  <p><b>4774</b> polea cigueñal 2.0/16v r.o. 8200386453</p>	<p><b>¡Nuevo!</b></p>  <p><b>4994</b> polea árbol de levas 1.9DTi-DCi (F9Q) r.o. 7700866844-7700107401</p>
<p><b>¡Nuevo!</b></p>  <p><b>4947</b>                    <b>desembragable</b> polea alternador 1.9D-1.5D, 5 canales r.o. 8200113636</p>	<p><b>¡Nuevo!</b></p>  <p><b>4948</b>                    <b>desembragable</b> polea alternador 1.4/16v-1.6/16v 6 canales r.o. 7700110616</p>	
<p><b>¡Nuevo!</b></p>  <p><b>4728</b>                    <b>sólida</b> polea alternador 1.9D-1.5D, 5 canales r.o.</p>	<p><b>¡Nuevo!</b></p>  <p><b>4729</b>                    <b>sólida</b> polea alternador 1.4/16v-1.6/16v 6 canales r.o.</p>	
<p><b>¡Nuevo!</b></p>  <p><b>4912</b>                    <b>Ø 61,00 mm</b> polea de alternador de rueda libre r.o.</p>	<p><b>¡Nuevo!</b></p>  <p><b>4913</b>                    <b>Ø 53,30 mm</b> polea de alternador de rueda libre r.o.</p>	<p><b>¡Nuevo!</b></p>  <p><b>4914</b>                    <b>Ø 55,40 mm</b> polea de alternador de rueda libre r.o.</p>
<p><b>¡Nuevo!</b></p>  <p><b>4717</b> cubrepedal freno y embrague r.o. 8200183752</p>	<p><b>¡Nuevo!</b></p>  <p><b>4711</b> soporte escape r.o. 8200310006</p>	<p><b>¡Nuevo!</b></p>  <p><b>4712</b> soporte escape (silicona) r.o. 8200453430</p>
 <p><b>667</b> tapón cárter aceite 1.4/16v-1.6/16v r.o. 7703075210</p>	 <p><b>670</b> tapón cárter aceite 1.9D-2.0/16v r.o. 7903075033</p>	



# RENAULT SAFRANE



**2703**  
silentbloc posterior brazo delantero  
r.o. 7700806239



**2704**  
silentbloc anterior brazo delantero  
r.o. 7700806238



**4243**  
bieleta puntal barra estabilizadora  
r.o. 7700805494



**1355**  
fuelle cremallera dirección  
r.o. 7701469657



**1517**  
kit rep. transmisión l/rueda (homocinética de Ø88 mm), r.o. 7701469021



**1432**  
kit rep. transmisión l/rueda (homocinética de Ø85 mm), r.o. 7701034800



**2304**      **rodamiento de Ø 28.0 mm**  
kit rep. transmisión **izquierda** l/cambio  
(Ø exterior boca grande 114 mm)

**¡Nuevo!**



**1139**      **rodamiento de Ø 28.0 mm**  
kit rep. transmisión **izquierda** l/cambio  
(Ø exterior boca grande 105 mm)



**670**  
tapón cárter de aceite todos modelos  
r.o. 7903075033

**¡Nuevo!**



**4724**  
varilla nivel aceite 2.2D  
r.o. 8200086256

**¡Nuevo!**



**4725**  
varilla nivel aceite 2.0-16v  
r.o. 8200138515

**¡Nuevo!**



**4641**  
jgo. tapas en culata 2.0/16v  
r.o. 7700106271+7700274026

**¡Nuevo!**

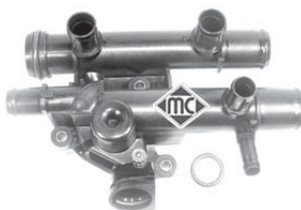

**3646**  
caja de termostato completa 2.2dT  
r.o. 8200262241

**¡Nuevo!**



**3648**  
tapón llenado aceite 2.2dT  
r.o. 8200009180



**2851**  
polea cigueñal 2.2dT Diesel G8T hasta '96  
r.o. 7700858731

**¡Nuevo!**



**4489**  
polea cigueñal 2.2dT Diesel G8T desde '96  
r.o. 7700104292

**¡Nuevo!**



**4463**      **6 canales**  
polea cigueñal 2.2dT Diesel G9T  
r.o. 8200468081

**¡Nuevo!**



**4585**      **7 canales**  
polea cigueñal 2.2dT Diesel G9T  
r.o. 8200458171













**96151**  
latiguillo freno delantero (420 mm)  
r.o.



**153**  
soporte filtro de aire  
r.o. 7704002509



## RENAULT SAFRANE

<p><b>iNuevo!</b></p>  <p><b>4728</b> polea alternador <b>5 canales</b> r.o. 8200113636</p> <p style="text-align: right;"><b>sólida</b></p>	<p><b>iNuevo!</b></p>  <p><b>4729</b> polea alternador <b>6 canales</b> r.o. 7700110616</p> <p style="text-align: right;"><b>sólida</b></p>	<p><b>iNuevo!</b></p>  <p><b>4641</b> juego tapas arboles de levas 2.0/16v r.o. 7700106271+7700274026</p>
<p><b>iNuevo!</b></p>  <p><b>4947</b>                    <b>desembragable</b> polea alternador <b>5 canales</b> r.o. 8200113636</p>	<p><b>iNuevo!</b></p>  <p><b>4948</b>                    <b>desembragable</b> polea alternador <b>6 canales</b> r.o. 7700110616</p>	
<p><b>iNuevo!</b></p>  <p><b>4912</b>                    <b>Ø 61,00 mm</b> polea de alternador <b>de rueda libre</b> r.o.</p>	<p><b>iNuevo!</b></p>  <p><b>4913</b>                    <b>Ø 53,30 mm</b> polea de alternador <b>de rueda libre</b> r.o.</p>	<p><b>iNuevo!</b></p>  <p><b>4914</b>                    <b>Ø 55,40 mm</b> polea de alternador <b>de rueda libre</b> r.o.</p>
 <p><b>417</b> cubrepedal freno y embrague r.o.</p>	 <p><b>2763</b> soporte tubo de escape r.o. 7700828897</p>	

## RENAULT TRAFIC-I (1986-2001)

### CANALIZACIONES DE AGUA:

#### TRAFIC-I 1.9 Diesel motor F8Q-1.870 cc (1997-2001)

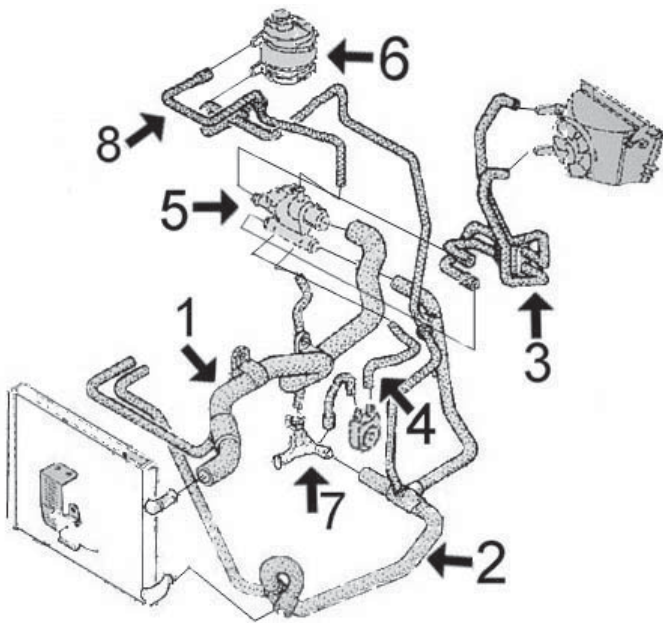

- 1- 8887 mgto sup radiador
- 2- 8886 mgto inf radiador
- 3- 8888 mgto doble calefactor
- 4- 8884 jgo mgto intercambiador filtro de aceite
- 5- 3569 cuerpo plástico completo con termostato
- 6- 3500 botella de expansión
- 3514 tapón botella de expansión 1,20 bar-marrón
- 7- 3167 boquilla metálica entrada agua a bloque motor
- 8- n/d mgto de caja de termostato a botella

- 8665 mgto desvaporizador
- 8666 mgto desvaporizador
- 8751 mgto desvaporizador

#### TRAFIC-I 2.1 Diesel motor J8S-2.068 cc (1985-1997)

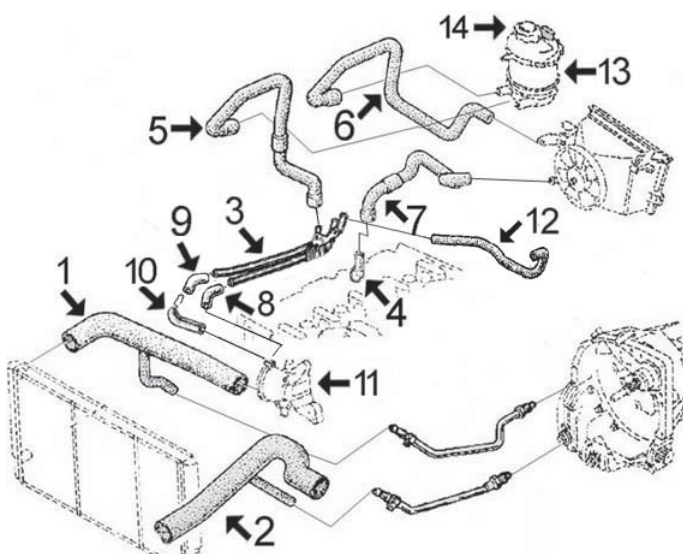

- 1- 8879 mgto sup radiador
- 2- 8880 mgto inf radiador
- 3- n/d tubo de agua metálico
- 4- 3033 boquilla en culata
- 5- 8881 mgto de tubo metálico a botella
- 6- 8872 mgto de botella a calefactor
- 7- 8882 mgto de culata a calefactor
- 8- 7998 mgto de tubo a caja termostato
- 9- 8098 mgto de tubo a racor
- 10- 7968 mgto de bomba a caja de termostato
- 11- 3120 tapa de termostato (aluminio)
- 12- 8099 mgto de tubo metálico a culata
- 13- 3500 botella de expansión
- 14- 3514 tapón botella de expansión (1,20 bar-marrón)







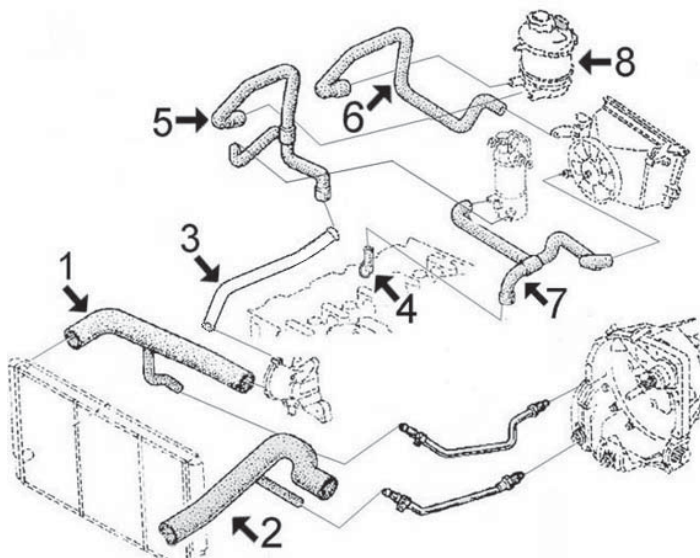



- 8128 mgto desvaporizador

# RENAULT TRAFIC-I (1986-2001)



















## TRAFIC-I 2.5 Diesel motor S8U-2.498 cc ( 1984-2001)



- 1- 8873 mgto sup radiador
- 2- 8875 mgto inf radiador
- 3- 3165 tubo de agua metálico
- 4- 3166 boquilla en culata
- 5- 8878 mgto de tubo metálico a botella y filtro de gasoil
- 6- 8872 mgto de botella a calefactor
- 7- 8877 mgto de culata a calefactor y filtro de gasoil
- 8- 3500 botella de expansión
- 3514 tapón botella de expansión 1,20 bar-marrón

 <p><b>3033</b> boquilla en culata 2.1 Diesel r.o. 7705030135</p>	 <p><b>3120</b> tapa de termostato 2.1 Diesel r.o. 7700656732</p>	 <p><b>3165</b> tubo de agua metálico 2.5 Diesel r.o. 7701039902</p>
 <p><b>3166</b> boquilla en culata 2.5 Diesel r.o. 7701041048</p>	 <p><b>3167</b> boquilla entrada agua a bloque 1.9 Diesel r.o. 7700300640</p>	
 <p><b>3500</b> botella de expansión 1.9D-2.1D-2.5D r.o. 7701203218</p>	 <p><b>3514</b> tapón botella de expansión 1,20 bar-marrón r.o. 7700805031</p>	 <p><b>3569</b> cuerpo con termostato 1.9 Diesel r.o. 7700474249</p>
 <p><b>7968</b> mgto de termostato a bomba 2.1 Diesel r.o. 7700733183</p>	 <p><b>7998</b> mgto de tubo a bomba 2.1 Diesel r.o. 7705026323</p>	 <p><b>8098</b> mgto de tubo metálico a racor 2.1 Diesel r.o. 7700742500</p>

## RENAULT TRAFIC-I (1986-2001)

 <p><b>8099</b> mgto de tubo metálico a culata 2.1 Diesel r.o. 6001040477</p>	 <p><b>8128</b> mgto desvaporizador 2.1 Diesel r.o. 7700733557</p>	 <p><b>8665</b> mgto desvaporizador 1.9 Diesel r.o.</p>
 <p><b>8666</b> mgto desvaporizador 1.9 Diesel r.o. 7700862370</p>	 <p><b>8751</b> mgto desvaporizador 1.9 Diesel r.o. 7700869572</p>	 <p><b>8872</b> mgto de botella a calefactor 2.1 D-2.5 D r.o.</p>
 <p><b>8873</b> mgto superior radiador 2.5 Diesel r.o.</p>	 <p><b>8875</b> mgto inferior radiador 2.5 Diesel r.o.</p>	 <p><b>8877</b> mgto de culata a calefactor y filtro 2.5D r.o.</p>
 <p><b>8878</b> mgto de tubo metálico a botella 2.5 Diesel r.o.</p>	 <p><b>8879</b> mgto superior radiador 2.1 Diesel r.o.</p>	 <p><b>8880</b> mgto inferior radiador 2.1 Diesel r.o.</p>
 <p><b>8881</b> mgto de tubo metálico a botella 2.1 Diesel r.o.</p>	 <p><b>8882</b> mgto de culata a calefactor 2.1 Diesel r.o.</p>	 <p><b>8884</b> juego mgto intercambiador 1.9 Diesel r.o.</p>
 <p><b>8886</b> mgto inferior radiador 1.9 Diesel r.o.</p>	 <p><b>8887</b> mgto superior radiador 1.9 Diesel r.o.</p>	 <p><b>8888</b> mgto doble calefactor 1.9 Diesel r.o.</p>



## SUSPENSION DELANTERA y SOPORTES de MOTOR:

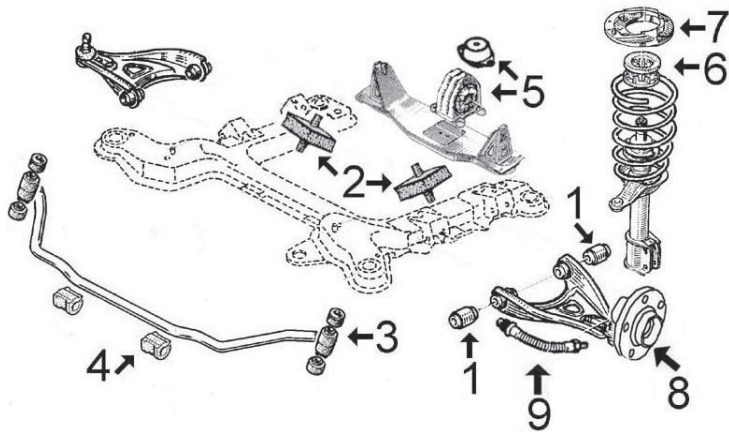

- 1- 2886 silentbloc trapecio delantero
- 2- 911 soporte motor 1.9D y 2.1D  
2962 soporte motor 2.5D
- 3- 4288 puntal barra estabilizadora hasta '89  
4475 puntal barra estabilizadora desde '89
- 4- 4484 goma barra estabilizadora Ø 17,00 mm  
4195 goma barra estabilizadora Ø 27,00 mm
- 5- 2885 soporte cambio todos mods. hasta '89  
4472 soporte cambio todos mods. desde '89
- 6- 4459 tope amortiguador delantero
- 7- 4194 soporte amortiguador delantero con rodamiento
- 8- 90093 buje rueda delantera 23 estrías  
90094 buje rueda delantera 25 estrías
- 9- 96076 latiguillo freno delantero (350mm)

## SUSPENSION TRASERA

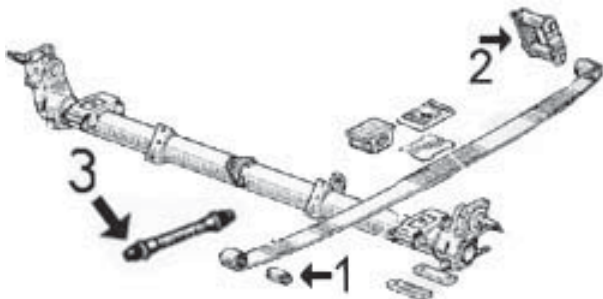

- 1- 4473 silentbloc anterior ballesta trasera
- 2- 4458 gemela posterior ballesta trasera completa  
2793 silentbloc de goma en gemela ballesta
- 3- 96104 latiguillo freno trasero

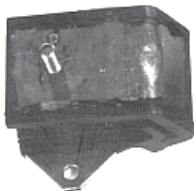

**911**  
soporte motor 1.9D - 2.1D  
r.o. 7700745290



**2793**  
goma gemelas ballesta trasera  
r.o. (montado en 7704001921)

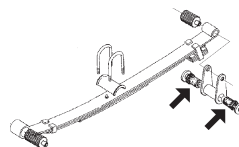

**2885**  
soporte cambio todos hasta '89  
r.o. 7700702890



**2886**  
silentbloc trapecio delantero  
r.o. 7701349064

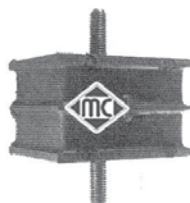















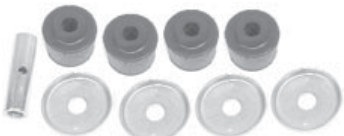



**2962**  
soporte motor 2.5 D  
r.o. 7700745292

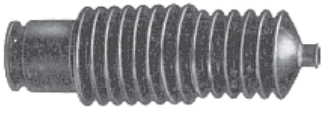
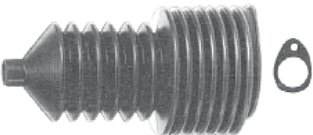

**4194**  
soporte amortiguador delantero con rodam.  
r.o. 7700734718

## RENAULT TRAFIC-I (1986-2001)

 <p><b>4195</b> goma barra estabilizadora delantera r.o. 7700667187</p> <p style="text-align: right;">Ø 27 mm</p>	<p><i>Nuevo!</i></p>  <p><b>4288</b> puntal barra estabilizadora hasta '89 r.o. 7704001232</p> <p style="text-align: right;">casquillo Ø 12 mm</p>	<p><i>Nuevo!</i></p>  <p><b>4458</b> gemela ballesta trasera completa r.o. 7704001921</p>
<p><i>Nuevo!</i></p>  <p><b>4459</b> tope goma amortiguador delantero r.o. 7700714835</p>	<p><i>Nuevo!</i></p>  <p><b>4472</b> soporte cambio todos mods. desde '89 r.o. 7700748646</p>	<p><i>Nuevo!</i></p>  <p><b>4473</b> silentbloc anterior ballesta trasera r.o. 7700730733</p>
<p><i>Nuevo!</i></p>  <p><b>4475</b> juego puntal barra estabiliz. delt. desde '89 r.o. 7700611100+7705046006+7700666914</p>	<p><i>Nuevo!</i></p>  <p><b>4484</b> goma barra estabilizadora delantera r.o. 7700667182</p> <p style="text-align: right;">Ø 17 mm</p>	
 <p><b>1733E</b> para montar con cono kit rep. transmisión l/rueda (trípode Ø 98) r.o. 7701013275</p>	 <p><b>1629E</b> para montar con cono kit reparación transmisión l/rueda (homocinética de Ø 102) r.o. 7701201810</p>	 <p><b>1733</b> kit rep. transmisión l/rueda (trípode Ø 98) r.o. 7701013275</p>
 <p><b>1523</b> kit rep. transmisión l/cambio r.o. 7701465021</p>	 <p><b>1265</b> fuelle izquierdo cremallera manual r.o. 7700653459</p>	 <p><b>1266</b> fuelle derecho cremallera manual r.o. 7700680852</p>
 <p><b>1561</b> fuelle cremallera asistida r.o. 7700781095</p>	 <p><b>2849</b> polea cigueñal motor 1.9D (F8Q) r.o. 7700112999</p>	 <p><b>2850</b> polea cigueñal motor 2.1 Diesel (J8S) r.o. 7700853470</p>
 <p><b>2862</b> casquillo palanca de cambio completo r.o. 7700863292</p>	<p><i>Nuevo!</i></p>  <p><b>4722</b> horquilla embrague motor F8Q 1.9D r.o.</p>	<p><i>Nuevo!</i></p>  <p><b>4723</b> horquilla embrague motor J8S 2.1D r.o.</p>

## RENAULT TRAFIC-I (1986-2001)



**262**  
soporte tubo de escape  
r.o. 7704001364



**280**  
soporte tubo de escape  
r.o. 7700686449



**4166**  
junta cónica colector escape 1.9 Diesel  
r.o. 8200035310



**416**  
cubrepedal freno y embrague  
r.o. 7903075033

**¡Nuevo!**



**90093**  
bujes rueda delantera 23 estrías  
r.o.

**¡Nuevo!**



**90094**  
bujes rueda delantera 25 estrías  
r.o.



**670**  
tapón cárter de aceite  
r.o. 7903075033



**96076**  
latiguillo freno delantero (350 mm)  
r.o. 7704003955-7704001953



**96104**  
latiguillo freno trasero (410 mm)  
r.o. 7704001955

**SUSPENSION DELANTERA y SOPORTES de MOTOR:**

motores 1.9D (F9Q), 2.5D (G9U) y 2.0-16v (F4R)

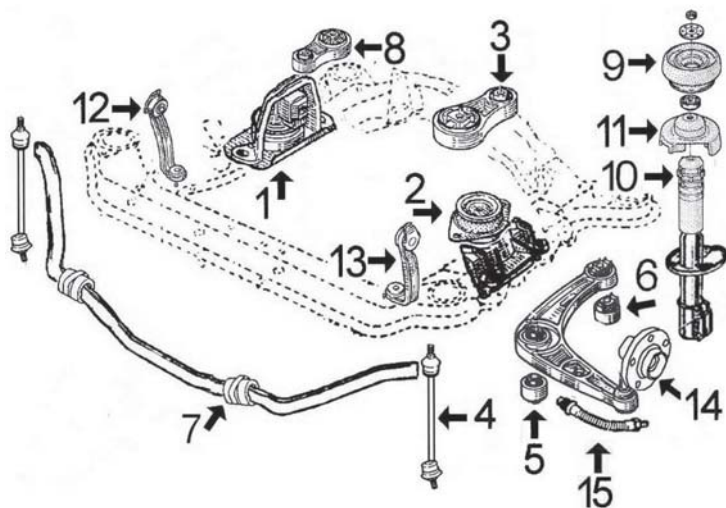

- 1- 4453 soporte motor derecho 1.9D y 2.0-16v
- 4450 soporte motor derecho 2.2D y 2.5D
- 2- 4451 soporte motor izquierdo 1.9D y 2.0-16v
- 4447 soporte motor izquierdo 2.5D
- 3- 4452 soporte motor trasero 1.9D y 2.0-16v
- 4449 soporte motor trasero 2.5D
- 4- 4457 bieleta puntal barra estabilizadora
- 5- 4487 silentbloc anterior trapecio delantero
- 6- 4488 silentbloc posterior trapecio delantero
- 7- n/d goma barra estabilizadora
- 8- 4448 bieleta antipar en soporte motor derecho todos
- 9- 4456 soporte amortiguador completo con rodamiento
- 10- 4589 capuchón amortiguador delantero
- 11- 4590 cazoleta superior muelle delantero
- 12- n/d soporte derecho subchasis delantero
- 13- n/d soporte izquierdo subchasis delantero
- 14- 90095 buje rueda delantera
- 15- 96204 latiguillo freno delantero (415 mm)



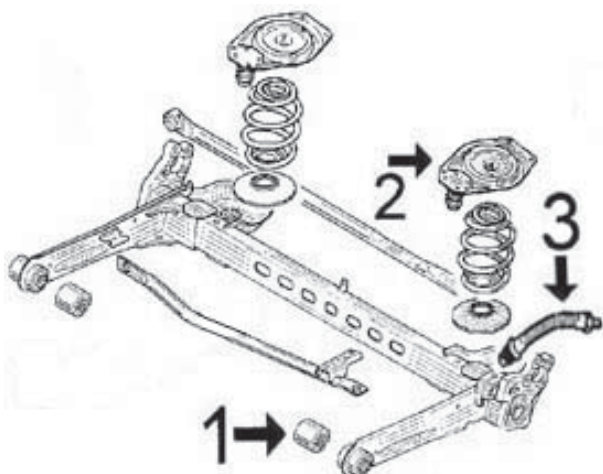







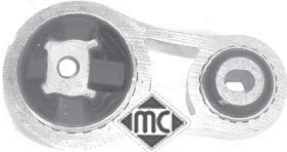

**SUSPENSION TRASERA**



- 1- 4454 silentbloc puente trasero
- 2- n/d soporte amortiguador trasero
- 3- 96205 latiguillo freno trasero (230 mm)



















## RENAULT TRAFIC-II (2001- )

<p><b>¡Nuevo!</b></p>  <p><b>4447</b> soporte motor izquierdo 2.5D r.o.</p>	<p><b>¡Nuevo!</b></p>  <p><b>4448</b> tirante reacción en soporte motor derecho r.o.</p>	<p><b>¡Nuevo!</b></p>  <p><b>4449</b> soporte motor trasero 2.5D r.o.</p>
<p><b>¡Nuevo!</b></p>  <p><b>4450</b> soporte motor derecho 2.5D r.o.</p>	<p><b>¡Nuevo!</b></p>  <p><b>4451</b> soporte motor izquierdo 1.9D y 2.0-16v r.o.</p>	<p><b>¡Nuevo!</b></p>  <p><b>4452</b> soporte motor trasero 1.9D y 2.0-16v r.o.</p>
<p><b>¡Nuevo!</b></p>  <p><b>4453</b> soporte motor derecho 1.9D y 2.0-16v r.o.</p>	<p><b>¡Nuevo!</b></p>  <p><b>4454</b> silentbloc puente trasero r.o.</p>	<p><b>¡Nuevo!</b></p>  <p><b>4456</b> soporte amortiguador completo con rodam. r.o.</p>
<p><b>¡Nuevo!</b></p>  <p><b>4457</b> bieleta puntal barra estabilizadora r.o.</p>	<p><b>¡Nuevo!</b></p>  <p><b>4487</b> silentbloc anterior trapecio delantero r.o.</p>	<p><b>¡Nuevo!</b></p>  <p><b>4488</b> silentbloc posterior trapecio delantero r.o.</p>
<p><b>¡Nuevo!</b></p>  <p><b>4589</b> capuchón amortiguador delantero r.o.</p>	<p><b>¡Nuevo!</b></p>  <p><b>4590</b> cazoleta apoyo superior muelle delantero r.o.</p>	<p><b>¡Nuevo!</b></p>  <p><b>90095</b> bujes rueda delantera r.o.</p>
<p><b>¡Nuevo!</b></p>  <p><b>96204</b> latiguillo frenodelantero (415 mm) r.o. 8200404264</p>	<p><b>¡Nuevo!</b></p>  <p><b>96205</b> latiguillo freno trasero (230 mm) r.o. 82000003480</p>	

## RENAULT TRAFIC-II (2001- )

<p><b>3645</b> <span style="float: right;"><b>89°</b></span>                  caja con termostato completa 1.9D (89°)                  r.o. 8200074346</p>	<p><b>3661</b> <span style="float: right;"><b>83°</b></span>                  caja con termostato completa 1.9D (83°)                  r.o. 8200074349</p>	<p><b>3646</b>                  caja de termostato completa 2.5D, 83°                  r.o. 8200262237-8200262241-8200154296</p>
<p><b>3119</b>                  tapa de termostato 2.0-16v                  r.o. 7700869797</p>	<p><b>3563</b>                  tapón botella de expansión                  r.o. 7700805131</p>	<p><b>3664</b>                  botella de expansión                  r.o.</p>
<p><b>4464</b> <span style="float: right;"><b>6 canales</b></span>                  polea cigueñal motor F4R 2.0-16v                  r.o. 8200276838</p>	<p><b>4611</b> <span style="float: right;"><b>7 canales</b></span>                  polea cigueñal motor F4R 2.0-16v                  r.o. 8200276840-8200451073</p>	<p><b>4736</b>                  polea cigueñal motor F4R 2.0-16v                  r.o. 7700116269-8200386453</p>
<p><b>4455</b> <span style="float: right;"><b>6 canales</b></span>                  polea cigueñal 1.9 Diesel                  r.o. 8200079183</p>	<p><b>4666</b> <span style="float: right;"><b>7 canales</b></span>                  polea cigueñal 1.9 Diesel                  r.o. 8200297937</p>	<p><b>4463</b>                  polea cigueñal 2.2/2.5 Diesel                  r.o. 8200213058</p>
<p><b>4585</b> <span style="float: right;"><b>7 canales</b></span>                  polea cigueñal 2.2/2.5 Diesel                  r.o. 8200207435</p>	<p><b>4724</b>                  varilla nivel aceite motor 2.5 Diesel                  r.o. 8200086256</p>	<p><b>4725</b>                  varilla nivel aceite motor 1.9D y 2.0                  r.o. 8200138515</p>
<p><b>3617</b>                  tapón llenado aceite motor                  r.o. 8200096805</p>	<p><b>4641</b>                  jgo. tapas árboles de levas 2.0-16v                  r.o. 7700106271+7700274026</p>	<p><b>4728</b> <span style="float: right;"><b>sólida</b></span>                  polea alternador <b>5 canales</b>                  r.o.</p>
<p><b>4729</b> <span style="float: right;"><b>sólida</b></span>                  polea alternador <b>6 canales</b>                  r.o.</p>	<p><b>4947</b> <span style="float: right;"><b>desembragable</b></span>                  polea alternador <b>5 canales</b>                  r.o. 8200113636</p>	<p><b>4948</b> <span style="float: right;"><b>desembragable</b></span>                  polea alternador <b>6 canales</b>                  r.o. 7700110616</p>

## RENAULT TRAFIC-II (2001- )

<p><b>4912</b> polea de alternador <b>de rueda libre</b> r.o. 7701473176</p> <p><i>¡Nuevo!</i></p>  <p style="text-align: center;">Ø 61,00 mm</p>	<p><b>4913</b> polea de alternador <b>de rueda libre</b> r.o. 7701473176</p> <p><i>¡Nuevo!</i></p>  <p style="text-align: center;">Ø 53,30 mm</p>	<p><b>4914</b> polea de alternador <b>de rueda libre</b> r.o. 7701473176</p> <p><i>¡Nuevo!</i></p>  <p style="text-align: center;">Ø 55,40 mm</p>
<p><b>1520</b> kit fuelle transmisión lado rueda r.o. 7701473176</p> 	<p><b>2304</b>      <b>rodamiento de Ø 28.0 mm</b> kit fuelle transmisión <b>izquierda</b> l/cambio (Ø exterior boca grande 114 mm)</p> 	<p><b>1139</b>      <b>rodamiento de Ø 28.0 mm</b> kit fuelle transmisión <b>izquierda</b> l/cambio (Ø exterior boca grande 105 mm)</p> <p><i>¡Nuevo!</i></p> 
<p><b>1135</b> kit fuelle transmisión <b>derecha</b> l/cambio r.o. 7701470910</p> <p><i>¡Nuevo!</i></p> 	<p><b>1107</b> fuelle cremallera dirección r.o. 7701473334</p> 	<p><b>4717</b> cubrepedal freno y embrague r.o. 7700416724-8200183752</p> <p><i>¡Nuevo!</i></p> 
<p><b>667</b> tapón cárter de aceite 1.9D r.o. 7703075210</p> 	<p><b>670</b> tapón cárter de aceite 2.0-16v y 2.5D r.o. 7903075033</p> 	<p><b>4474</b> soporte tubo de escape todos mods. r.o. 7700416724-8200183752</p> <p><i>¡Nuevo!</i></p> 
<p><b>9095</b> mgto desvaporizador con válvula 1.9Diesel r.o. 8200063371-8200136128</p> <p><i>¡Nuevo!</i></p> 	<p><b>3714</b> decantador completo 2.0 gasolina r.o. 7700416724-8200183752</p> <p><i>¡Nuevo!</i></p> 	<p><b>3717</b> decantador completo 1.9Diesel r.o. 7700416724-8200183752</p> <p><i>¡Nuevo!</i></p> 
<p><b>4994</b> polea árbol de levas 1.9DTi-DCi (F9Q) r.o. 7700866844-7700107401</p> <p><i>¡Nuevo!</i></p> 		



# RENAULT TWINGO

## CANALIZACIONES DE AGUA

TWINGO hasta 5/'96 (motor 1.200 cc C3G)

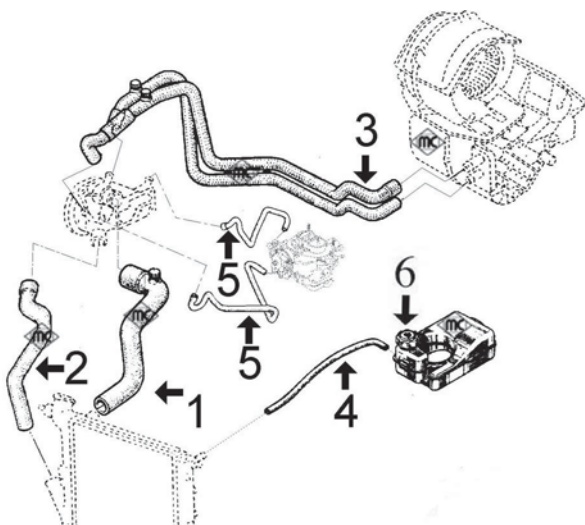

- 1- 8317 mgto superior radiador
- 2- 8419 mgto inferior radiador sin aire acondicionado  
8325 mgto inferior radiador con aire acondicionado
- 3- 8421 mgto doble de bomba a calefactor
- 4- 5445 mgto de radiador a botella
- 5- 8420 juego de mgtos de bomba de agua a carburador
- 6- 3564 botella de expansión  
3525 tapón botella de expansión 1.4 bar

TWINGO desde 5/'96 hasta 10/'97 (motor 1.200 cc D7F-700)

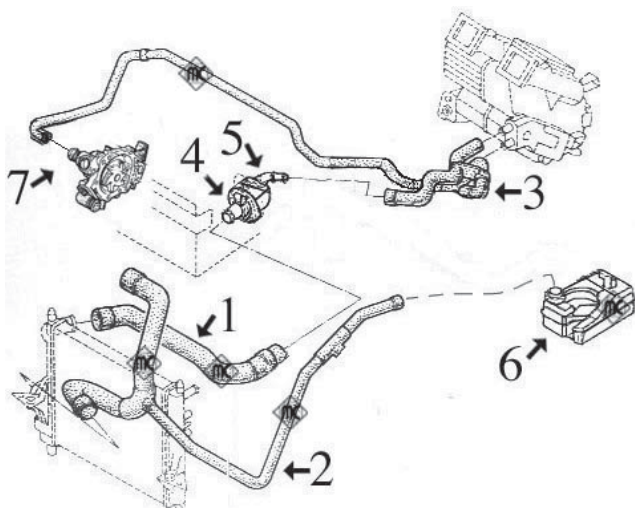

- 1- 8780 mgto superior radiador sin aire acondicionado  
8779 mgto superior radiador con aire acondicionado
- 2- 8817 mgto inferior radiador sin aire acondicionado  
8816 mgto inferior radiador con aire acondicionado
- 3- 8793 mgto doble de bomba a calefactor y tapa termostato
- 4- 3156 tapa con termostato  
2889 tapón de goma para salida tapa de termostato
- 5- 3147 cuerpo de termostato
- 6- 3564 botella de expansión  
3525 tapón botella de expansión 1.4 bar
- 7- 3148 boquilla metálica en tapa bomba de agua

TWINGO desde 10/'97 hasta 9/'00 (motor 1.200 cc D7F-702 de 8 válvulas)

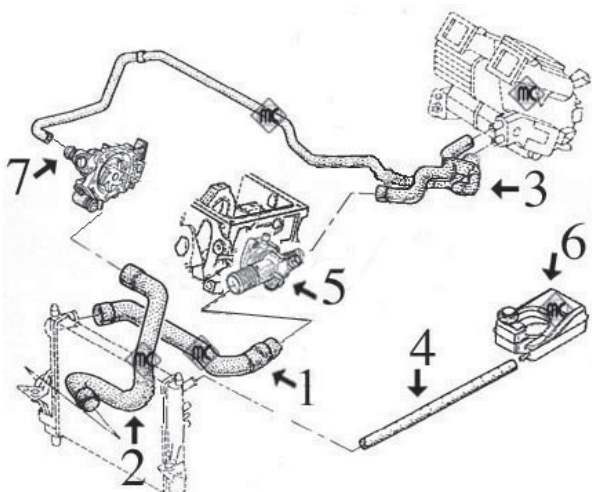

- 1- 8780 mgto superior radiador sin aire acondicionado  
8779 mgto superior radiador con aire acondicionado
- 2- 8782 mgto inferior radiador sin aire acondicionado  
8781 mgto inferior radiador con aire acondicionado
- 3- 8793 mgto doble de bomba a calefactor y tapa termostato
- 4- 5445 mgto de botella a radiador
- 5- 3147 caja de termostato completa
- 6- 3671 botella de expansión  
3563 tapón botella de expansión 1.4 bar
- 7- 3148 boquilla metálica en tapa bomba de agua



## RENAULT TWINGO



**5445**  
mgto de radiador a botella  
r.o. 7700822053



**8317**  
mgto superior radiador motor C3G  
r.o. 7700822051 - 7700822055



**8325**  
mgto inferior radiador C3G con aire acond.  
r.o. 7700822056



**8419**  
mgto inferior radiador C3G sin aire acond.  
r.o. 7700822052

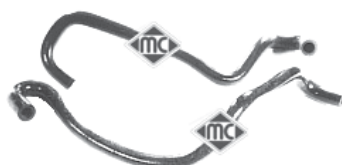

**8420**  
juego de mgto de bomba a carburador C3G  
r.o. 7700857195 + 7700857196



**8421**  
mgto doble de bomba a calefactor C3G  
r.o. 7700822054



**8779**  
mgto superior radiador D7F aire acondi-  
cionado hasta 10/'97, r.o.



**8780**  
mgto superior radiador D7F sin aire acond.  
hasta 10/'97, r.o.



**8781**  
mgto inferior radiador D7F con aire acondi-  
cionado desde 10/'97, r.o.



**8782**  
mgto inferior radiador D7F sin aire acondi-  
cionado desde 10/'97, r.o.



**8793**  
mgto doble de calefactor a bomba D7F  
r.o.



**8816**  
mgto inferior radiador D7F con aire acondi-  
cionado hasta 10/'97, r.o.



**8817**  
mgto inferior radiador D7F sin aire acondi-  
cionado hasta 10/'97, r.o.

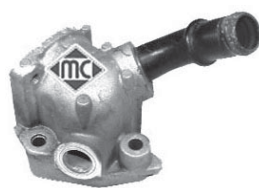

**3147**  
cuerpo de termostato motor D7F hasta '97  
r.o. 7700864962



**3148**  
boquilla metálica en tapa bomba de agua  
r.o.



**3156**  
tapa con termostato motor D7F hasta '97  
r.o. 7700868980



**3525**  
tapón botella de expansión hasta '97 1.4 bar  
r.o. 7700805031



**3563**  
tapón botella de expansión desde '97  
r.o. 8200048024

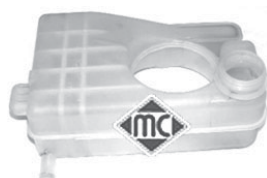

**3564**  
botella de expansión hasta '97  
r.o. 7701467287

**¡Nuevo!**



**3669**  
caja de termostato completa desde '97  
r.o. 7700110716

**¡Nuevo!**

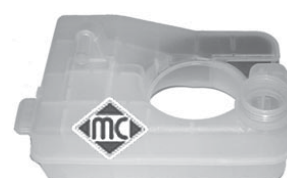

**3671**  
botella de expansión desde '97  
r.o. 7701473018

# RENAULT TWINGO

## SUSPENSIÓN DELANTERA y SOPORTES DE MOTOR

motores C3G y D7F de 8 válvulas hasta 9/'00

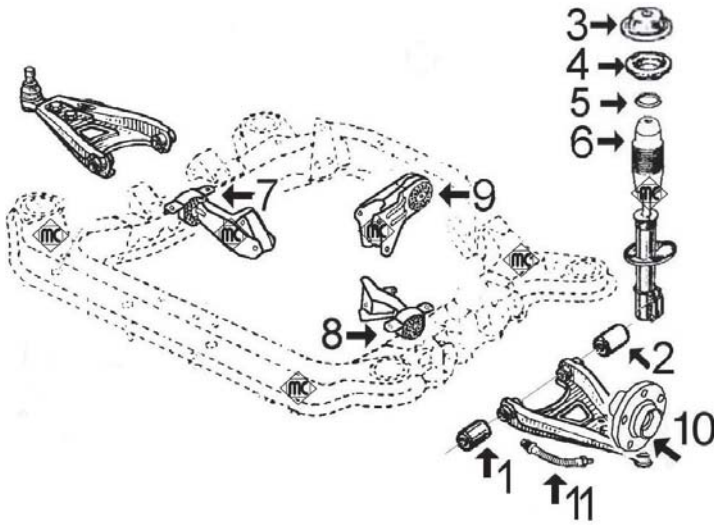

- 1- 2681 silentbloc anterior trapecio delantero
- 2- 2680 silentbloc posterior trapecio delantero
- 3- 4153 tapa superior con tuerca amortiguador delantero
- 4- 2821 soporte amortiguador delantero
- 5- 4180 rodamiento soporte amortiguador delantero
- 6- 2847 capuchón amortiguador delantero
- 7- 4075 soporte motor derecho sin aire acondicionado hasta 5/'96 (motor C3G)
- 4112 soporte motor derecho con aire acondicionado hasta 5/'96 (motor C3G)
- 4276 soporte motor derecho desde 5/'96 (motor D7F)
- 8- 4074 soporte motor izquierdo
- 9- 4099 soporte motor trasero
- 10- 90015 buje rueda delantera
- 11- 96076 latiguillo freno delantero (350 mm)

motores D4F y D4D de 16 válvulas desde 9/'00

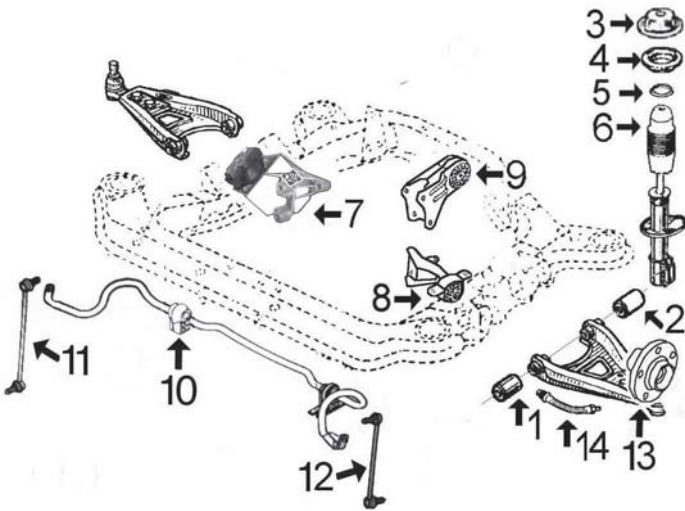

- 1- 2681 silentbloc anterior trapecio delantero
- 2- 2680 silentbloc posterior trapecio delantero
- 3- 4153 tapa superior con tuerca amortiguador delantero
- 4- 2821 soporte amortiguador delantero
- 5- 4180 rodamiento soporte amortiguador delantero
- 6- 2847 capuchón amortiguador delantero
- 7- 4678 soporte motor derecho
- 8- 4074 soporte motor izquierdo
- 9- 4099 soporte motor trasero
- 10- 2631 goma barra estabilizadora
- 11- 4673 bieleta derecha puntal barra estabilizadora
- 12- 4674 bieleta izquierda puntal barra estabilizadora
- 13- 90015 buje rueda delantera
- 14- 96076 latiguillo freno delantero (350 mm)

## SUSPENSIÓN TRASERA, todos modelos

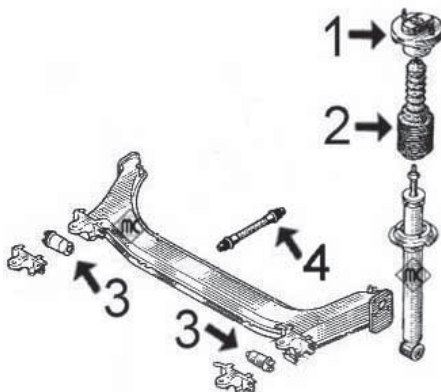

- 1- 4198 soporte amortiguador trasero
- 2- n/d capuchón amortiguador trasero
- 3- 4681 silentbloc soporte puente trasero
- 4- 96161 latiguillo freno trasero (270 mm)
- 96096 latiguillo freno trasero (220 mm)
- 96110 latiguillo freno trasero (245 mm)

## RENAULT TWINGO



**2631**  
goma barra estabilizadora deasde 9/00  
r.o. 8200024373



**2681**  
silentbloc anterior trapecio delantero  
r.o. 7700819929



**2680**  
silentbloc posterior trapecio delantero  
r.o. 7700831364



**2847**  
capuchón amortiguador delantero  
r.o. 7700819237



**2821**  
soporte superior amortiguador delantero  
r.o. 7700827435



**4074**  
soporte motor izquierdo  
r.o. 7700821670-7700425709



**4075**  
soporte motor derecho hasta 5/96 sin aire acondicionado, r.o. 7700821668



**4099**  
soporte motor trasero  
r.o. 7700425711



**4112**  
soporte motor derecho hasta 5/96 con aire acondicionado, r.o. 7700827544



**4153**  
tapa con tuerca amortiguador delantero  
r.o. 7700426450



**4180**  
rodamiento soporte amortiguador delantero, r.o. 6001025850



**4198**  
soporte amortiguador trasero  
r.o. 7700846916

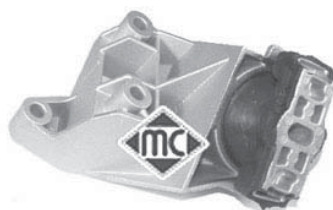

**4276**  
soporte motor derecho desde 5/96  
r.o. 7700412094



**4673**  
bieleta derecha puntal barra estabilizadora  
r.o. 8200050191



**4674**  
bieleta izquierda puntal barra estabilizadora  
r.o. 8200040618

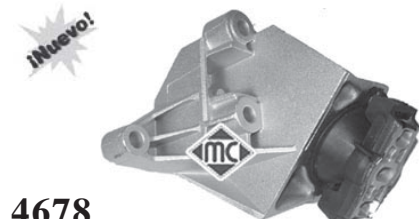

**4678**  
soporte motor derecho motores de 16v  
r.o. 8200025319



**4681**  
silentbloc puente trasero  
r.o. 7700821167



**90015**  
bujes rueda delantera  
r.o. 7700719140



**96076**  
latiguillo freno delantero (350 mm)  
r.o. 7704003955



**96161**  
latiguillo freno trasero (268 mm)  
r.o. 7704003549



# RENAULT TWINGO



**96096**  
latiguillo freno trasero (220 mm)  
r.o. 7704003957



**96110**  
latiguillo freno trasero (245 mm)  
r.o. 7700834990

## ARTICULACIONES PALANCA DE CAMBIO

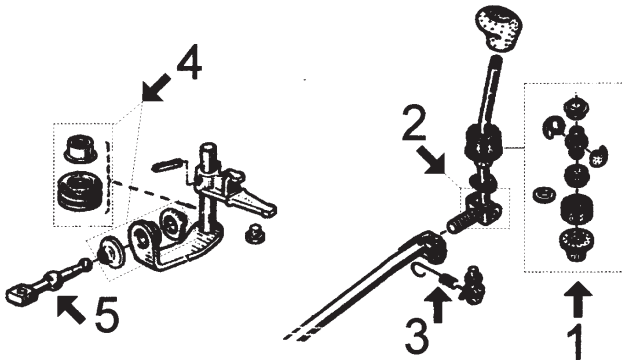

- 1- 516 juego casquillos rótula palanca
- 2- 2797 juego pasador y casquillos eje inferior palanca
- 3- 2372 muelle de retorno completo
- 4- 908 juego casquillos y retén selector
- 5- 2883 bieleta del selector hasta '98  
4287 bieleta del selector desde '98



**516**  
juego casquillos rótula palanca  
r.o. 7700464111



**2797**  
juego casquillos y pasador eje palanca  
r.o. no hay despiece



**2372**  
muelle de retorno palanca completo  
r.o. 7701468199



**498**  
serreta pedal embrague completa  
r.o. 7700679621



**908**  
juego casquillos-retén selector  
r.o. 7700679960+7700703000



**2883**  
bieleta selector velocidades hasta '98  
r. 7700875584+7700872205+7700743133



**4287**  
bieleta selector velocidades desde '98  
r.o. 7700102476



**4297**  
horquilla embrague completa  
r.o. 7700725720



**1350 kit**                      **350 fuelle**  
fuelle cremallera dirección  
r.o. 7700678649



**444**  
casquillo cremallera dirección  
r.o. 7704000926



**1517**  
kit reparación transmisión l/rueda  
r.o. 7701467125



**1537**  
kit reparación transm. **izquierda** l/cbo.  
con rodam. Ø 25,80 mm, r.o. 7701468575



## RENAULT TWINGO

**nuevo!**



**1128**

kit rep. transmisión **derecha** l/cambio hasta '97 (**Ø 20-80 mm**), r.o. 7701469389



**1559**

kit rep. transmisión **derecha** l/cambio desde '97 (**Ø 23-65 mm**), r.o. 7701471522



**4278**

collarín empalme tubo de escape  
r.o.



**2725**

soporte tubo de escape  
r.o. 7700410929



**4166**

**Ø 66 x 52 mm**  
junta cónica tubo de escape  
r.o.



**667**

tapón cárter de aceite 16X150  
r.o. 7703075210

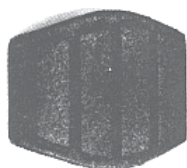

**417**

cubrepedal freno y embrague  
r.o. 7700680836

## ROVER

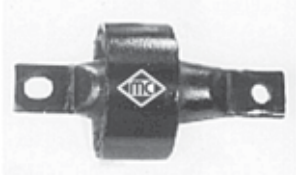

**2707**  
silentbloc puente trasero series 200/400  
r.o. RGX100980-52385BR3000



**053**  
soporte escape  
r.o.



**1221E**  
kit rep. transmisión l/rueda Metro  
r.o. BAU4445



**1342**  
kit rep. transmisión l/rueda 111-114-200-211  
(bocas Ø20-78 mm), r.o. BAU4441



**1633**  
kit rep. transmisión l/rueda 213 hasta '90  
r.o. ADU4909



**1216**  
kit rep. transmisión l/rueda 216-218-220  
(bocas Ø23-80 mm), r.o.



**3609**  
tapón de radiador (boca pequeña) 1.10 bar  
r.o.



**3608**  
tapón de radiador (boca grande) 1.2 bar  
r.o.

SEAT 600 - 124 - 131



**5417**  
mgto superior radiador 600



**5418**  
mgto inferior radiador 600



**5117**  
mgto de culata a bomba 600-850-133



**5445**  
mgto calefactor 850-133 (largo 820 mm)



**200**  
silentbloc mangueta (12x32x34x40)



**415**  
goma amortiguador (14x11x38)



**292**  
silentbloc reenvio dirección (dentado)



**293**  
silentbloc trapecio delantero

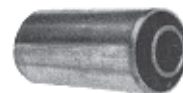

**295**  
silentbloc ballesta 600 (14x27x50x56)



**180**  
flector de transmisión 600



**182**  
capuchón palier 600

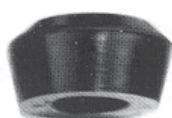

**104**  
silentbloc tirante y puente trasero 124-131

(13x40x42x30)



**129**  
silentbloc tirante trasero 124-131 (pequeño)

(14x41x47x30)



**163**  
silentbloc tirante trasero 124-131 (mediano)

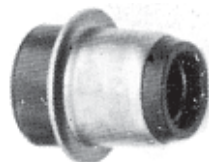

**143**  
silentbloc trapecio inferior 124



**144**  
silentbloc trapecio superior 124



**022**  
goma amortiguador



**549**  
goma amortiguador 124-132

SEAT 600 - 124 - 131



**309**  
funda goma muelles suspensión

**245**  
goma varilla nivel aceite

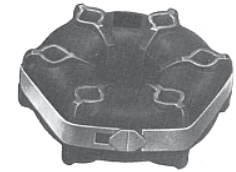
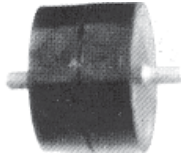

**203**  
soporte motor 124-131-132

**2476**  
soporte motor 131-Sofim

**220**  
flector de transmisión

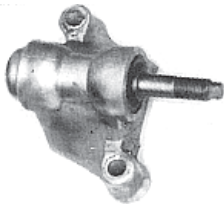

**301**  
caja de reenvío 124

**1757**  
fuelle derecho cremallera asistida (Sofim)

**1758**  
fuelle izquierdo cremallera asistida (Sofim)

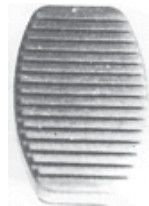
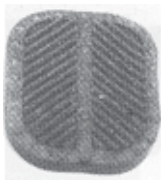

**411**  
cubrepedal freno y embrague 124-131

**413**  
cubrepedal freno y embrague 132

**243**  
soporte tubo escape 131



**160**  
soporte tubo escape 131-132

**156**  
soporte tubo escape 124

**158**  
soporte tubo escape 124



**676**  
tapón cárter (cónico) 22x1.5

**675**  
tapón cárter (cónico) 22x1.5

**96088**  
latiguillo freno delantero 850-124













**96087**  
latiguillo freno delantero 600

**96097**  
latiguillo freno trasero 600

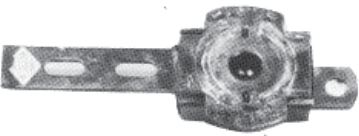
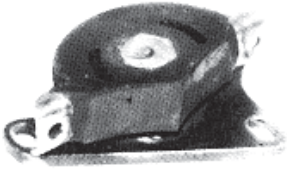

## SEAT 127

 <p><b>5631</b> mgto superior radiador</p>	 <p><b>5632</b> mgto inferior radiador</p>	 <p><b>5633</b> mgto de bomba de agua a termostato</p>
 <p><b>5827</b> mgto del calefactor</p>	 <p><b>5828</b> mgto del calefactor (largo 720 mm)</p>	 <p><b>7290</b> mgto del carburador</p>
 <p><b>3007</b> tubo de agua metálico</p>	 <p><b>7287</b>      Ø 48x55, largo 145 mm tubo llenado combustible</p>	 <p><b>245</b> goma varilla nivel aceite</p>
 <p><b>289</b> casquillo interior cremallera</p>	 <p><b>257</b> fuelle derecho cremallera dirección</p>	 <p><b>258</b> fuelle izquierdo cremallera dirección</p>
 <p><b>1170</b> kit rep. transmisión lado rueda</p>	 <p><b>313</b> capuchón lado cambio con retén mod. Fura</p>	 <p><b>176</b> capuchón lado cambio con retén</p>
 <p><b>585</b> baquelita soporte bomba de gasolina</p>	 <p><b>717</b> tirante elástico mando cambio Fura (d/'82)</p>	 <p><b>299</b> soporte cambio desde '79 (127-CL)</p>
 <p><b>251</b> (altura casquillo central 54 mm) soporte motor izquierdo 127-CL (desde '79)</p>	 <p><b>259</b> (altura casquillo central 48 mm) soporte motor derecho 127-CL (desde '79)</p>	

SEAT 127



**269**  
silentbloc extremo brazo suspensión delt.

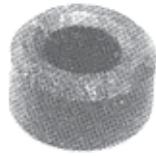

**140**  
goma central brazo suspensión delantero

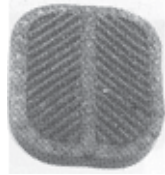

**411**  
cubrepedal freno y embrague



**477**  
juego casquillos rótula palanca cambio



**326**  
juego casquillos palanca cambio completo

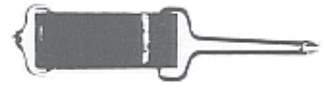

**296**  
tirante tubo escape hasta '82



**390**  
collarín colector completo



**156**  
tirante tubo escape



**676**  
tapón de cárter, exágono interior 22x1.5



**675**  
tapón de cárter, exágono exterior 22x1.5



**96083**  
latiguillo freno delantero



**96088**  
latiguillo freno trasero

## CANALIZACIONES DE AGUA

SHARAN motores 1.9 TDi y 2.0 gasolina hasta 2000:

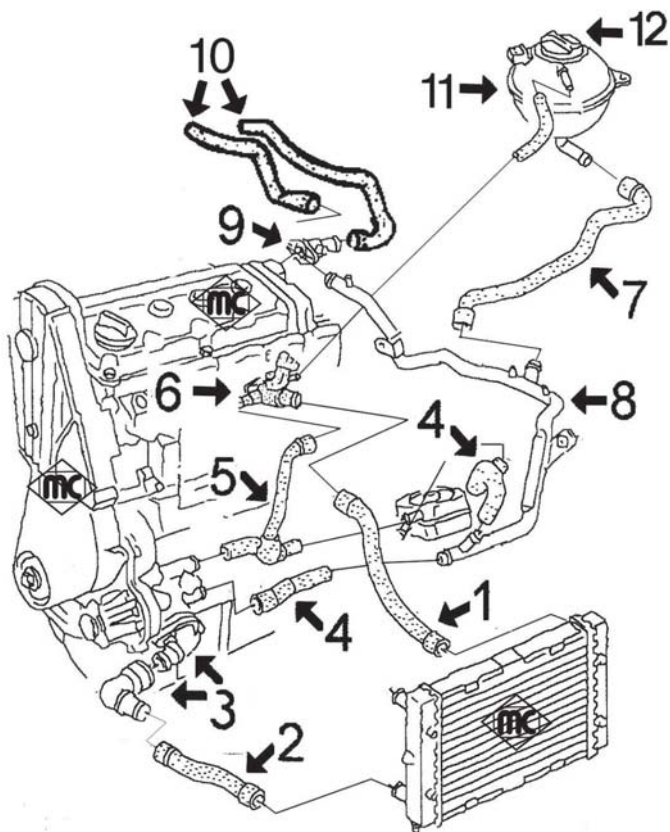

- 1- 8889 mgtto superior radiador
- 2- 8890 mgtto inferior radiador
- 3- 3667 boquilla en bomba de agua hasta '01  
3597 boquilla en bomba de agua desde '01
- 4- 8891 juego mgtos de tubo metálico a intercambiador y de tubo metálico a bomba de agua
- 5- 8394 mgtto de bomba de agua a brida en culata e intercambiador 2.0 gasolina  
8382 mgtto de bomba de agua a brida en culata e intercambiador 1.9TDi de 90cv  
8893 mgtto de bomba de agua a brida en culata e intercambiador 1.9TDi de 110cv
- 6- 3522 brida en culata conexión mgtos 2.0 gasolina  
3542 brida en culata conexión mgtos 1.9TDi
- 7- 8894 mgtto de tubo metálico a botella
- 8- 3170 tubo de agua metálico 2.0 gasolina  
3168 tubo de agua metálico 1.9TDi
- 9- 3517 boquilla en culata hasta '00  
3591 boquilla en culata 1.9TDi desde '00
- 10- 8892 juego mgtos entrada/salida calefactor
- 11- 3649 botella de expansión
- 12- 3650 tapón botella de expansión

## MANGUITOS DESVAPORIZADORES 1.9TDi y 2.0 gasolina

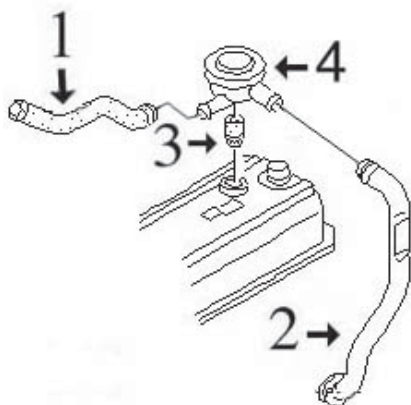

- 1- 8895 mgtto desvaporizador
- 2- 3644 tubo plástico desvaporizador 1.9TDi  
n/d tubo plástico desvaporizador 2.0 gasolina
- 3- 2669 junta válvula desvaporizadora
- 4- 3719 válvula desvaporizadora

## SEAT ALHAMBRA

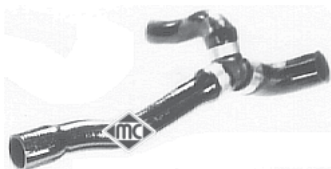

**8382**  
mgtto de bomba a brida en culata 1.9TDi de 90cv, r.o.



**8394**  
mgtto de bomba a brida en culata 2.0 r.o.



**8889**  
mgtto superior radiador 1.9TDi y 2.0 r.o.



**8890**  
mgtto inferior radiador 1.9TDi y 2.0 r.o.



**8891**  
jgo mgttos de tubo metálico a bomba de agua y a intercambiador, r.o.



**8892**  
jgo mgttos entrada/salida calefactor r.o.



**8893**  
mgtto de bomba a brida en culata 1.9TDi de 110cv, r.o.



**8894**  
mgtto de tubo metálico a botella expansión r.o.



**8895**  
mgtto desvaporizador 1.9TDi y 2.0 r.o.

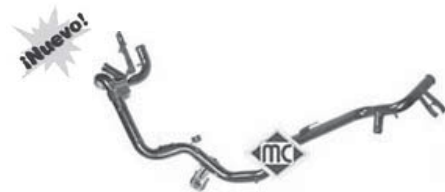

**3168**  
tubo de agua metálico 1.9TDi r.o. 7M0121065AA/AE



**3170**  
tubo de agua metálico 2.0 gasolina r.o. 7M0121065AF



**3517**  
boquilla en culata 2.0 y 1.9TDi hasta '00 r.o. 026121145E



**3522**  
brida frontal en culata 2.0 gasolina r.o.



**3542**  
brida frontal en culata 1.9TDi r.o.



**3591**  
boquilla en culata 1.9TDi desde '00 r.o.



**3597**  
boquilla en culata 2.0 y 1.9TDi desde '00 r.o. 06A121121C



**3644**  
tubo plástico desvaporizador 1.9Diesel r.o. 028103491J



**3649**  
botella de expansión r.o. 7M0121407A-7M3121407A



**3650**  
tapón botella de expansión r.o. 7M0121321C-7M3121321C



**3667**  
boquilla en bomba de agua completa r.o. 037121619+037121121A



**3719**  
válvula desvaporizadora 1.9TDi-2.0 r.o. 028129101D





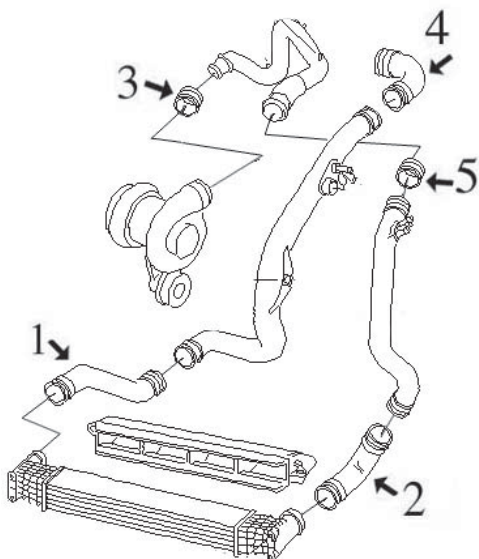

CANALIZACIONES de AIRE de ALTA PRESION INTERCOOLER-TURBO:

SHARAN 1.9 Diesel motores TDi desde 9/'95 a 2/'00:  
(AHU-1Z-AFN-AVG)



- 1- n/d tubo flexible de tubo a intercooler
- 2- n/d tubo flexible de tubo a intercooler
- 3- 9062 tubo flexible de turbo a tubo rígido
- 4- n/d tubo de colector a tubo rígido
- 5- 9061 tubo flexible de empalme

<p><b>¡Nuevo!</b></p>  <p><b>9061</b> Ø 50x60 largo 58 mm tubo flexible de alta presión r.o. 1H0145834E</p>	<p><b>¡Nuevo!</b></p>  <p><b>9062</b> Ø 35x45 largo 58 mm tubo flexible de alta presión r.o. 3A0145972A</p>	

## SUSPENSION DELANTERA y SOPORTES DE MOTOR:

SHARAN todos tipos desde '96 hasta '01:

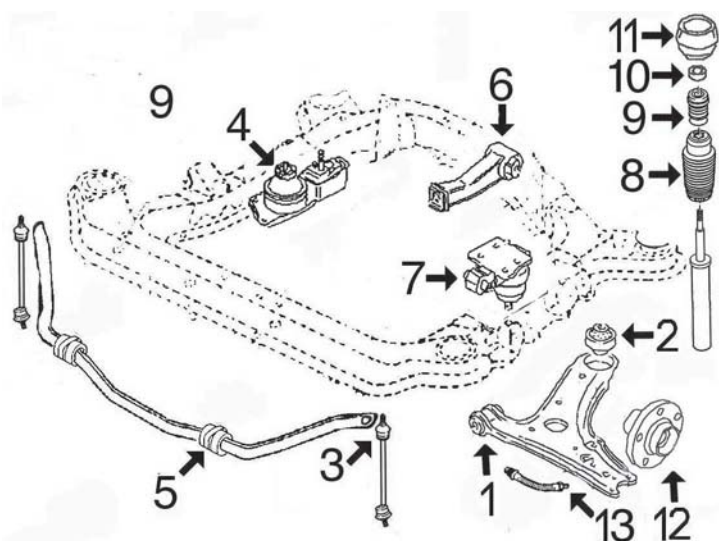

- 1- 4279 silentbloc anterior trapecio delantero
- 2- 4280 silentbloc posterior trapecio delantero
- 3- 4261 bieleta puntal barra estabilizadora
- 4- 4556 soporte motor derecho
- 5- 4555 goma barra estabilizadora
- 6- 4559 soporte motor trasero 1.9TDi de 90cv y 2.0  
4560 soporte motor trasero 1.9TDi de 110cv y 1.8T
- 7- 4557 soporte motor izquierdo
- 8- 4324 capuchón amortiguador delantero
- 9- 4254 tope poliuretano amortiguador delantero
- 10- 4128 rodamiento soporte amortiguador
- 11- 2812 soporte amortiguador completo con rodamiento
- 12- 90064 buje rueda delantera
- 13- 96069 latiguillo freno delantero (500 mm)

SHARAN todos tipos desde '01:

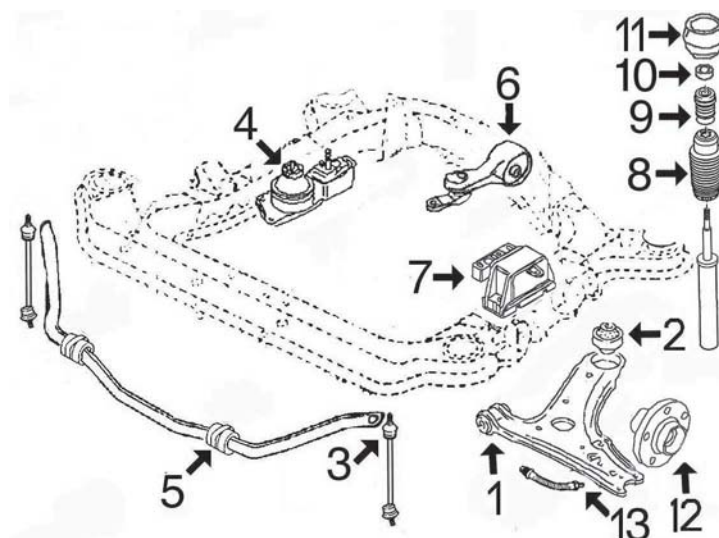





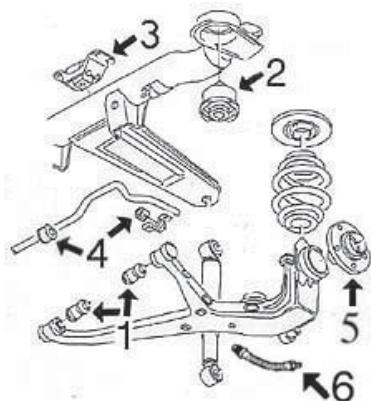





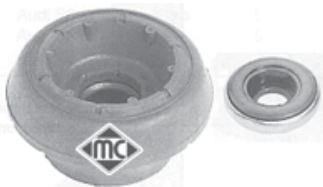









- 1- 4279 silentbloc anterior trapecio delantero
- 2- 4280 silentbloc posterior trapecio delantero
- 3- 4261 bieleta puntal barra estabilizadora
- 4- 4556 soporte motor derecho
- 5- 4555 goma barra estabilizadora
- 6- 4561 soporte motor trasero
- 7- 4558 soporte motor izquierdo
- 8- 4324 capuchón amortiguador delantero
- 9- 4298 tope poliuretano amortiguador delantero
- 10- 4128 rodamiento soporte amortiguador
- 11- 2812 soporte amortiguador completo con rodamiento
- 12- 90064 buje rueda delantera
- 13- 96069 latiguillo freno delantero (500 mm)

## SUSPENSION TRASERA:



- 1- 4279 silentbloc trapecio suspensión trasera
- 2- n/d silentbloc sub-chasis trasero
- 3- 4603 soporte travesía suspensión trasera
- 4- 4618 juego gomas barra estabilizadora trasera
- 5- 90064 buje rueda trasera
- 6- 96070 latiguillo freno trasero (185 mm)

## SEAT ALHAMBRA

 <p><b>4128</b> rodamiento soporte amortiguador delantero r.o. 1J0412249</p>	 <p><b>2812</b> soporte amortiguador delantero completo r.o.</p>	 <p><b>4254</b> tope poliuretano amortiguador delantero hasta '01, r.o.</p>
 <p><b>4261</b> bieleta puntal barra estabilizadora r.o. 7M0411317D</p>	 <p><b>4279</b> silentbloc anterior trapecio delantero y suspensión trasera, r.o. 7M0501541</p>	 <p><b>4280</b> silentbloc posterior trapecio delantero r.o. 7M0407181A</p>
 <p><b>4298</b> tope poliuretano amortiguador delantero r.o. 1H0412303B</p>	 <p><b>4324</b> capuchón amortiguador delantero r.o. 357413175A</p>	 <p><b>4555</b> goma barra estabilizadora delantera r.o. 7M0411031</p>
 <p><b>4556</b> soporte motor derecho r.o. 7M0199132AH/AA/M/T/R</p>	 <p><b>4557</b> soporte motor izquierdo hasta '01 r.o. 7M0199131AP/AF</p>	 <p><b>4558</b> soporte motor izquierdo desde '01 r.o. 7M3199555B/R/K</p>
 <p><b>4559</b> soporte motor trasero 1.9TDi (90cv) y 2.0 r.o. 7M0399201BR/BT</p>	 <p><b>4560</b> soporte motor trasero 1.9TDi (110cv) y 1.8T r.o. 7M0399201BQ/CC</p>	 <p><b>4561</b> soporte motor trasero todos desde '01 r.o. 7M3399201H/J/K/G</p>
 <p><b>4603</b> soporte traviesa suspensión trasera r.o. 7M0555221C</p>	 <p><b>4618</b> juego gomas barra estabilizadora trasera r.o. 7M0511413A+7M0555414B</p>	
 <p><b>90064</b> bujes rueda delantera y trasera r.o. 7M0501655D</p>	 <p><b>96069</b> latiguillo freno delantero (500 mm) r.o. 7M0611701D</p>	 <p><b>96070</b> latiguillo freno trasero (185 mm) r.o. 7M0611776B/C</p>

## SEAT ALHAMBRA



**1321**  
fuelle izqdo. y dcho. cremallera  
r.o. 7M3422831



**1225**  
kit fuelle transmisión lado rueda  
r.o. 7M0498203-7M0498203A



**1069**  
kit fuelle transmisión lado cambio  
r.o. 7M0498201



**3568**  
guía varilla nivel aceite 1.8T  
r.o. 06A103663B

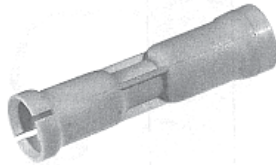

**2448**  
guía varilla nivel aceite 2.0 hasta '99  
r.o. 053103663



**3553**  
guía varilla nivel aceite 2.0 desde '99  
r.o. 06A103663C



**2876**  
guía varilla nivel aceite 1.9 TDi (salvo ANU)  
r.o. 028103663B



**3571**  
guía varilla nivel aceite 1.9 TDi (ANU)  
r.o. 038103663



**4760**  
varilla nivel aceite 1.9TDi-2.0  
r.o. 027115611C



**4290**  
polea cigueñal 1.9 D-TD-TDi hasta '99  
r.o. 028105243T



**4421**  
polea cigueñal 1.9 TDi desde '99-  
r.o. 038105243K



**4405**  
polea cigueñal 1.8T-2.0 gasolina  
r.o. 06A105243E



**4768** Ø 78 mm  
rodillo tensor correa alternador 1.9TDi-2.0  
r.o. 028145278E

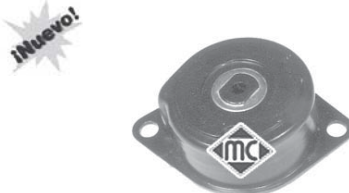

**4908**  
tensor correa alternador 1.9TDi hasta '99  
r.o. 028903315R



**4909**  
tensor correa alternador 2.0 gasolina  
hasta '99, r.o. 037903315C

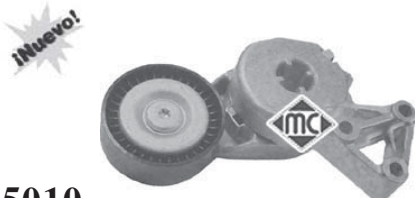

**5010**  
tensor correa alternador 1.8 desde '00-  
r.o. 06A903315E



**4919** Ø 55/50 mm, H=40,5 mm  
polea de alternador de rueda libre  
r.o. 028903119AA



**4999** Ø 61/55 mm, H=41 mm  
polea de alternador de rueda libre  
r.o. 038903119



**4997** Ø 61/55 mm, H=41 mm  
polea de alternador de rueda libre  
r.o. 038903119T



**3672**  
válvula filtro gasoil 1.9D hasta '99  
r.o. 191127247A



**3689**  
válvula filtro gasoil 1.9D desde '99  
r.o. 1J0127247-247A -247E



## SEAT ALHAMBRA



**4365**

jgo. tornillo sujeción tapa cubremotor  
r.o.028103665+028103937+028103638G



**864**

cubrepedal freno y embrague  
r.o.321721173



**2669**

junta válvula desvaporizadora  
r.o.028103500

**¡Nuevo!**



**3731**

interruptor luz de freno (4 polos) hasta 12/'02  
r.o. 1J0945511A

**¡Nuevo!**



**3739**

interruptor luz de freno (2 polos)  
r.o. 191945511A/B

**¡Nuevo!**



**3738**

interruptor luz de freno (4 polos) desde  
12/'02, r.o. 1J0945511C/D



**2426**

soporte tubo de escape  
r.o. 1H0253147B



**674**

tapón cárter de aceite hasta '98 (salvo V6)  
r.o. N90288901



**2916**

tapón cárter de aceite desde '98 (salvo V6)  
r.o. N90813201



**2780**

junta colector escape 1.9 TDi  
r.o.028129589B

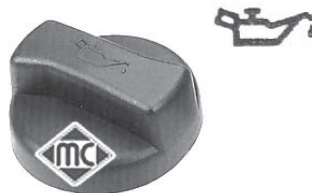

**3621**

tapón llenado aceite motor  
r.o.06B103485B

CANALIZACIONES DE AGUA

**AROSA 1.0** motores AER-AHT-ALL-ALD  
**1.4** motores AEX-AKK-ANW-APQ  
**1.4** motores 16v. AFK-AUB-AQQ

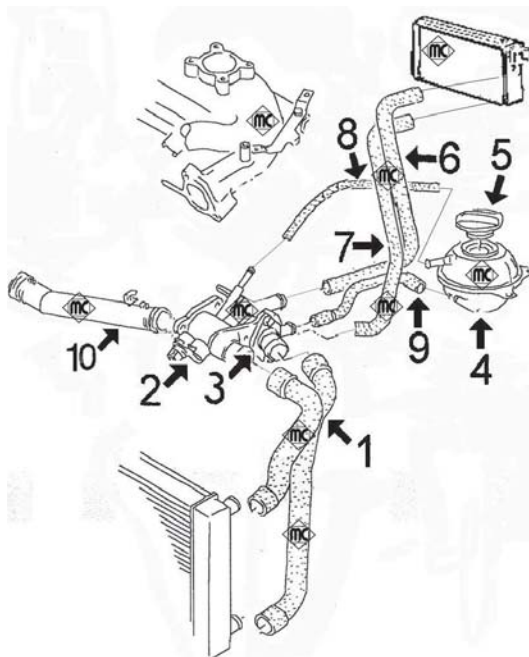

- 1- 8797 mgto superior e inferior radiador (ensamblados)
- 2- 3615 cuerpo de termostato completo con termostato, tapa y accesorios
- 3- 3592 kit de termostato completo con tapa y junta  
3541 tapa de termostato
- 4- 3610 botella de expansión
- 5- 3676 tapón botella de expansión
- 6- 8803 mgto entrada agua a calefactor
- 7- 8806 mgto retorno agua de calefactor
- 8- 116 mgto sobrante de botella a termostato: cortar de rollo MC-116 Ø 8x14 mm, long. aprox. 350 mm
- 9- 8798 mgto de cuerpo termostato a botella
- 10- 3625 tubo de agua (plástico) con juntas tóricas





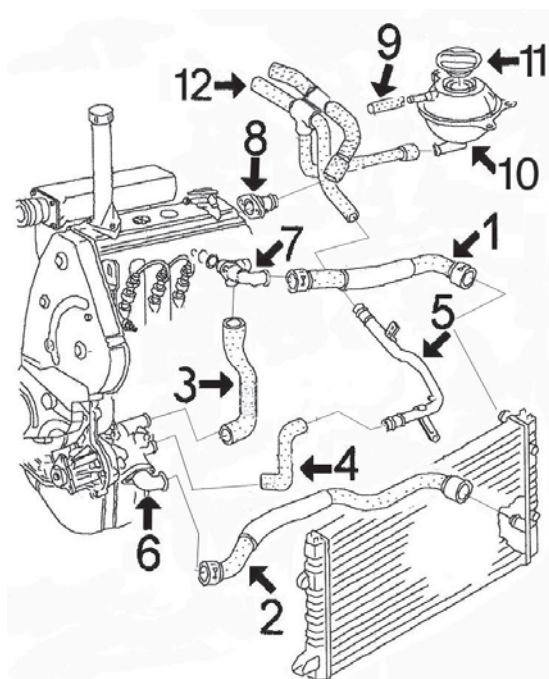















8811 mgto desvaporizador

**AROSA 1.7 Diesel** motor AKU "SDi"

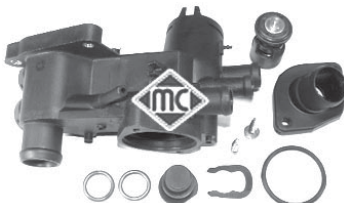

- 1- 8804 mgto superior radiador
- 2- 8805 mgto inferior radiador
- 3- 8808 mgto de bomba agua a racor en culata
- 4- 8810 mgto de bomba agua a tubo metálico
- 5- 3157 tubo de agua metálico
- 6- 3528 tapa de termostato
- 7- 3585 racor en culata
- 8- 3517 boquilla lateral en culata
- 9- 116 mgto sobrante de botella: cortar de rollo MC-116 Ø 8x14 mm, long. aprox. 400 mm
- 10- 3610 botella de expansión
- 11- 3676 tapón botella de expansión
- 12- 8814 mgto doble de calefactor

## SEAT AROSA

 <p><b>8797</b> mgto superior/inferior radiador 1.0-1.4 r.o.</p>	 <p><b>8798</b> mgto de cuerpo termostato a botella 1.0-1.4 r.o.</p>	 <p><b>8803</b> mgto entrada calefactor 1.0-1.4 r.o.</p>
 <p><b>8804</b> mgto superior radiador 1.7 Diesel r.o.</p>	 <p><b>8805</b> mgto inferior radiador 1.7 Diesel r.o.</p>	 <p><b>8806</b> mgto retorno calefactor 1.0-1.4 r.o.</p>
 <p><b>8808</b> mgto de bomba agua a racor en culata 1.7 D r.o.</p>	 <p><b>8810</b> mgto de bomba agua a tubo metálico 1.7 D r.o.</p>	 <p><b>8811</b> mgto desvaporizador 1.0-1.4 r.o.</p>
 <p><b>8814</b> mgto doble de calefactor 1.7 Diesel r.o.</p>	 <p><b>3157</b> tubo de agua metálico 1.7 Diesel r.o.6N0121065G</p>	 <p><b>3517</b> boquilla en culata (lateral) 1.7 Diesel r.o.026121144E</p>
 <p><b>3528</b> tapa de termostato r.o.030121121B</p>	 <p><b>3541</b> tapa de termostato 1.0-1.4 r.o.032121121B/J</p>	 <p><b>3585</b> racor en culata (frontal) 1.7 Diesel r.o.028121132C</p>
 <p><b>3592</b> kit completo de termostato, tapa y junta 1.0-1.4,r.o.032121121J+032121110B</p>	 <p><b>3615</b> cuerpo de termostato 1.0-1.4 completo <b>con termostato</b>, tapa y accesorios</p>	 <p><b>3625</b> tubo de agua (plástico) 1.4 con juntas tóricas,r.o.032121065D</p>
 <p><b>3540</b> jgo. tapón, junta y pasador para cubrir tomas para sensores en tapas de agua</p>	 <p><b>3610</b> botella de expansión r.o.6N0121407C</p>	 <p><b>3676</b> tapón botella de expansión r.o.1H0121321D</p>

SUSPENSION DELANTERA y SOPORTES DE MOTOR

1.0 - 1.4 - 1.4/16v - 1.7D-SDi:

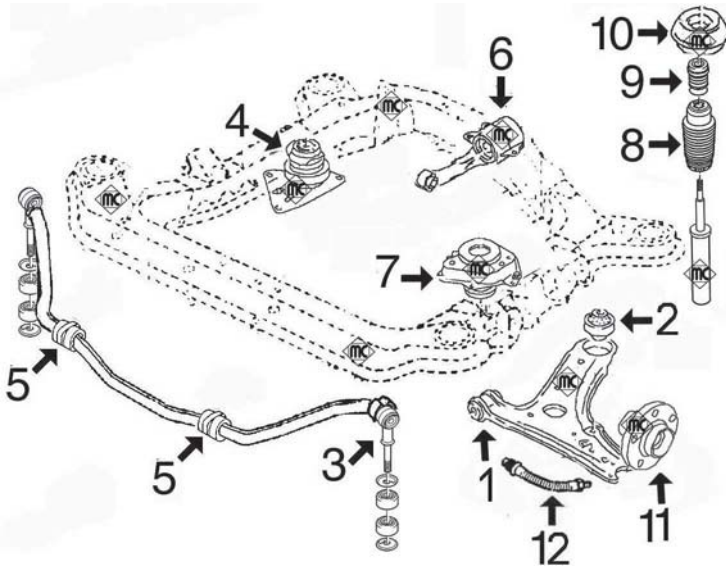

- 1- 2859 silentbloc anterior trapecio delantero
- 2- 2858 silentbloc posterior trapecio delantero
- 3- 2853 bieleta puntal barra estabilizadora completa
- 4- 4095 soporte motor derecho 1.0-1.4 (gasolina)
- 4317 soporte motor derecho 1.7D
- 5- 4318 goma para barra estabilizadora de 18 mm
- 4319 goma para barra estabilizadora de 20 mm
- 6- 4169 soporte motor trasero
- 7- 4096 soporte motor izquierdo 1.0-1.4
- 4415 soporte motor izquierdo 1.7D-1.7SDi
- 8- 4324 capuchón amortiguador delantero
- 9- 4298 tope poliuretano amortiguador delantero
- 10- 2877 soporte superior amortiguador delantero completo con rodamiento
- 11- 90034 buje rueda delantera
- 12- 96128 latiguillo freno delantero (410 mm)

1.4 TDi (desde 10/'99-)

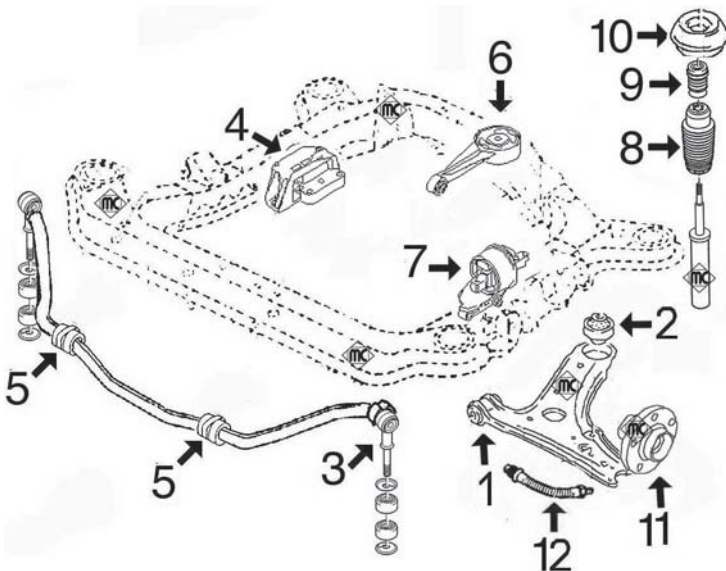

- 1- 2859 silentbloc anterior trapecio delantero
- 2- 2858 silentbloc posterior trapecio delantero
- 3- 2853 bieleta puntal barra estabilizadora completa
- 4- 4790 soporte motor derecho
- 5- 4318 goma para barra estabilizadora de Ø 18 mm
- 4319 goma para barra estabilizadora de Ø 20 mm
- 6- 4784 soporte motor trasero
- 7- 4783 soporte motor izquierdo
- 8- 4324 capuchón amortiguador delantero
- 9- 4298 tope poliuretano amortiguador delantero
- 10- 2877 soporte superior amortiguador delantero completo con rodamiento
- 11- 90034 buje de rueda delantera
- 12- 96128 latiguillo freno delantero (410 mm)



SUSPENSION TRASERA:

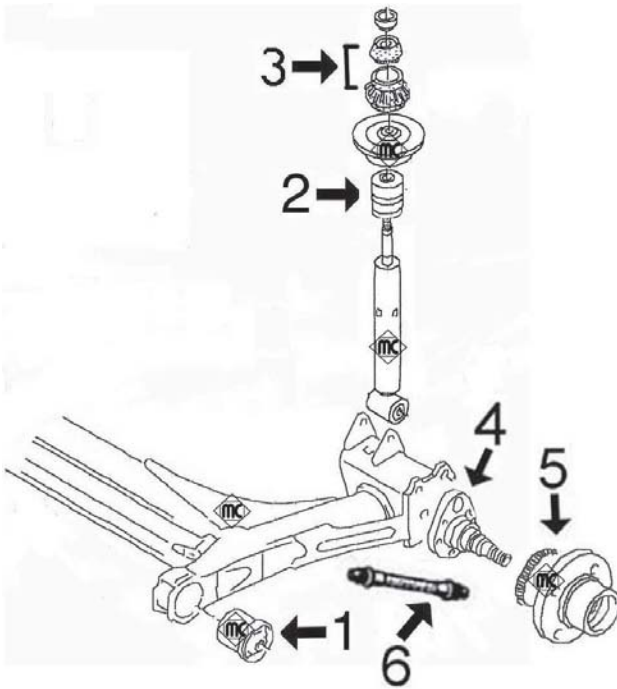

- 1- 2839 silentbloc puente trasero
- 2- 4299 tope poliuretano amortiguador trasero
- 3- 4320 jgo. soportes amortiguador trasero
- 4- 90539 mangueta rueda trasera izquierda hasta 5/'98  
90540 mangueta rueda trasera derecha hasta 5/'98
- 5- 90525 buje rueda trasera con rodamiento desde 5/'98
- 6- 96014 latiguillo freno trasero (165 mm)



**2839**  
silentbloc puente trasero  
r.o. 6N0501541D



**2853**  
bioleta puntal barra estabilizadora **completa**  
r.o. 6N0411315



**2858**  
silentbloc posterior trapecio delantero  
r.o. 6N0407181



**2859**  
silentbloc anterior trapecio delantero  
r.o. no hay despiece, va con el brazo



**2877**  
soporte amortiguador delantero completo  
**con rodamiento** r.o. 6N0412331A+1J0412249



**4095**  
soporte motor derecho 1.0 - 1.4  
r.o. 6N0199262A



**4096**  
soporte motor izquierdo 1.0-1.4  
r.o. 6N0199555G/C/AA



**4169**  
soporte motor trasero  
r.o. 6N0199851AG



**4298**  
tope poliuretano amortiguador delantero  
r.o. 1H0412303B

## SEAT AROSA



**4299**  
tope poliuretano amortiguador trasero  
r.o. 6N0512131A

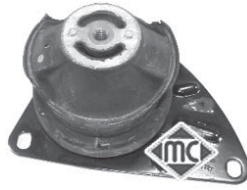

**4317**  
soporte motor derecho 1.7 Diesel  
r.o. 6N0199262K



**4318**  
goma para barra estabilizadora de 18 mm  
r.o. 6X0411313



**4319**  
goma para barra estabilizadora de 20 mm  
r.o. 6X0411313A



**4320**  
juego soportes amortiguador trasero  
r.o. 191512335+191512333



**4324**  
fuelle amortiguador delantero  
r.o. 357413175A



**4415**  
soporte motor izquierdo 1.7D-1.7SDi  
r.o. 6N0199555H

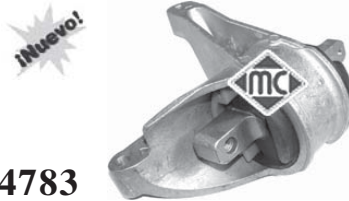

**4783**  
soporte motor izquierdo 1.4TDi  
r.o. 6N0199543F



**4784**  
soporte motor trasero 1.4TDi  
r.o. 6N0199851AF

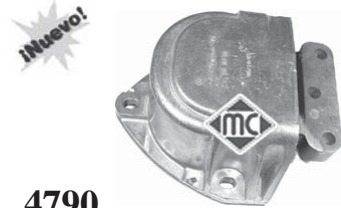

**4790**  
soporte motor derecho 1.4TDi  
r.o. 6N0199167BF

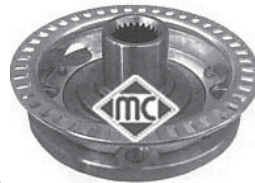

**90034**  
buje rueda delantera  
r.o. 6N0407613



**90539**  
mangueta rueda tras **izquierda** hasta 5/98  
r.o. 333501117A



**90540**  
mangueta rueda trasera **derecha** hasta 5/98  
r.o. 333501118A



**90525**  
buje rueda trasera **con rodamiento** desde 5/98, r.o. 6X0598477





















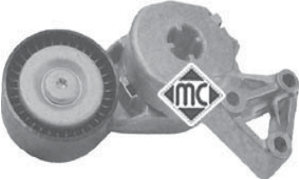

**96128**  
latiguillo freno delantero (410 mm)  
r.o. 6N0611701A/B



**96014**  
latiguillo freno trasero (165 mm)  
r.o. 6X0611775

## SEAT AROSA

<p><b>¡Nuevo!</b></p>  <p><b>4492</b> polea cigueñal 1.4TDi r.o.045105243B-045105243</p>	<p><b>¡Nuevo!</b></p>  <p><b>4495</b> polea cigueñal 1.7D/SDi r.o.028105243AC</p>	
 <p><b>4355</b> guía varilla nivel aceite 1.0-1.4-1.4/16v r.o.030115636A</p>	<p><b>¡Nuevo!</b></p>  <p><b>4793</b> varilla nivel aceite 1.0-1.4-1.4/16v r.o.</p>	<p><b>¡Nuevo!</b></p>  <p><b>4794</b> varilla nivel aceite 1.4TDi r.o.</p>
<p><b>¡Nuevo!</b></p>  <p><b>4791</b> varilla nivel aceite 1.7D/SDi r.o.030115636A</p>	 <p><b>3621</b> tapón llenado aceite motor r.o.026103485</p>	<p><b>¡Nuevo!</b></p>  <p><b>4770</b> tensor correa alternador 1.0-1.4-1.4/16v r.o.030145299F</p>
<p><b>¡Nuevo!</b></p>  <p><b>4767</b> rodillo tensor correa alternador 1.0-50CV r.o.038145276</p>	<p><b>¡Nuevo!</b></p>  <p><b>4771</b> tensor correa alternador 1.0-50CV-1.7D/SDi r.o.028145278M</p>	<p><b>¡Nuevo!</b></p>  <p><b>4923</b> tensor correa alternador 1.7D/SDi r.o.028903315P</p>
<p><b>¡Nuevo!</b></p>  <p><b>5010</b> tensor correa alternador 1.4TDi r.o.06A903315E</p>	<p><b>¡Nuevo!</b></p>  <p><b>4997</b>      Ø 61/55 mm, H=45 mm polea de alternador de rueda libre r.o.022903119A</p>	<p><b>¡Nuevo!</b></p>  <p><b>5000</b>      Ø 61/55 mm, H=37 mm polea de alternador de rueda libre r.o.038903119Q</p>
 <p><b>4353</b> bieleta mando cambio 1.7 Diesel r.o.6N0711575A</p>	<p><b>¡Nuevo!</b></p>  <p><b>4903</b> casquillo guía embrague 1.0-1.4-1.4/16v-1.7D r.o.085141181</p>	<p><b>¡Nuevo!</b></p>  <p><b>4749</b> casquillo guía embrague 1.4TDi r.o.02A141180A</p>
<p><b>¡Nuevo!</b></p>  <p><b>3672</b> válvula filtro gasoil hasta 5/00 r.o.191127247A</p>	<p><b>¡Nuevo!</b></p>  <p><b>3689</b> válvula filtro gasoil desde 5/00 r.o.1J0127247-1J0127247A</p>	<p><b>¡Nuevo!</b></p>  <p><b>4296</b> kit reparación distribuidor Magneti-Marelli (casquillo sinterizado del eje rotor)</p>

## SEAT AROSA

**¡Nuevo!**



**3739**

conmutador luz de freno (2 polos, hasta 7/01)  
r.o. 191945515-191945515A/B

**¡Nuevo!**

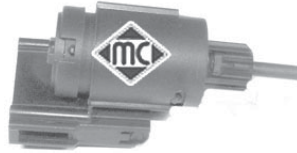

**3738**

conmutador luz de freno (4 polos, desde 7/01), r.o. 1J09455111D/C



**1436**

fuelle cremallera dirección salvo 1.4TDi  
r.o. 6N0419831



**1357**

fuelle cremallera dirección 1.4TDi  
r.o. 6N0422831



**864**

cubrepedal freno y embrague  
r.o. 321721173



**1921**

kit fuelle transmisión lado rueda  
r.o. 6N0498203



**1632**

kit fuelle transmisión lado cambio  
r.o. 6N0498201



**4365**

jgo. tornillo sujeción tapa cubremotor  
r.o. 028103665+028103937+028103638G



**674**

tapón de cárter M-14x150  
r.o.



**2426**

soporte delantero tubo de escape  
r.o. 1H0253147B



**4273**

soporte trasero tubo de escape  
r.o. 6x0253144b

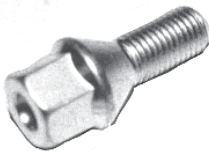

**792**

tornillo rueda M-12x150x23,5  
r.o. 3A0601139



# SEAT IBIZA - MALAGA (1984-1993)

## CANALIZACIONES DE AGUA

### IBIZA - MALAGA 1.2/1.5 (carburador):

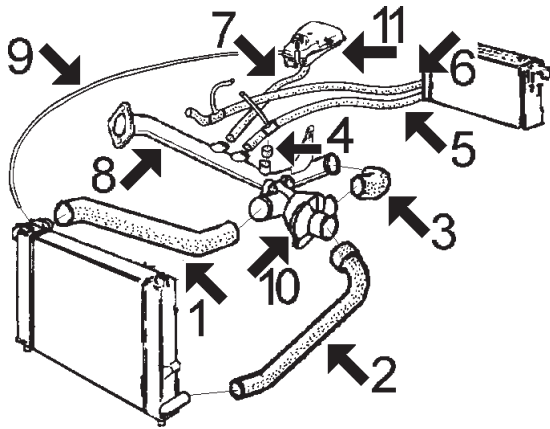

- 1- 5120 mgtto superior radiador
- 2- 5119 mgtto inferior radiador
- 3- 5118 mgtto de termostato a tubo metálico
- 4- 119 mgtto de tubo metálico a colector de admisión: Cortar de rollo MC-119 Ø 16x22 mm, longitud 25 mm.
- 5- 7335 mgtto izquierdo de calefactor a tubo metálico y a carburador (3 vias)\*
- 6- 7335 mgtto derecho de calefactor a boquilla en culata y a carburador (3 vias)\*
- 7- 843 mgtto de botella a tubo metálico: Cortar de rollo MC-843 Ø 19x25 mm, longitud 650 mm
- 8- 3002 tubo de agua metálico
- 9- 116 mgtto sobrante de botella a radiador: Cortar de rollo MC-116 Ø 8x14 mm, long. aprox. 950 mm
- 10- 3118 tapa de termostato
- 11- 3510 botella de expansión  
3607 tapón de radiador 0,7 bar

### IBIZA - MALAGA 1.5 SXI (inyección):

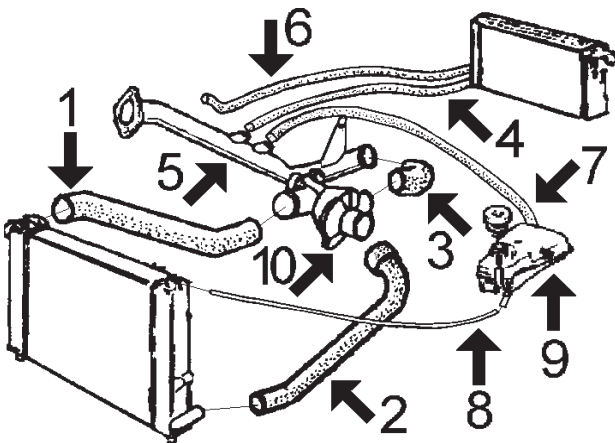

- 1- 7796 mgtto superior radiador
- 2- 5119 mgtto inferior radiador
- 3- 5118 mgtto de termostato a tubo de agua metálico
- 4- 7336 mgtto de calefactor a tubo de agua metálico
- 5- 3013 tubo de agua metálico
- 6- 7336 mgtto de calefactor a culata
- 7- 843 mgtto de botella a tubo de agua metálico: Cortar de rollo MC-843 Ø 19x25 mm, longitud 850 mm
- 8- 116 mgtto de sobrante de botella a radiador: Cortar de rollo MC-116 Ø 8x14 mm, longitud 550 mm
- 9- 3510 botella de expansión  
3607 tapón de radiador 0,7 bar
- 10- 3118 tapa de termostato

8021 mgtto desvaporizador de gases

### IBIZA - MALAGA 1.7 DIESEL:

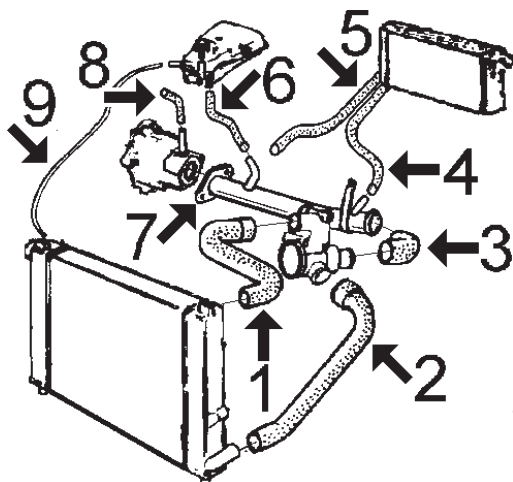

- 1- 5122 mgtto superior radiador
- 2- 5121 mgtto inferior radiador
- 3- 7355 mgtto de termostato a tubo de agua metálico
- 4- 7336 mgtto de calefactor a tubo metálico
- 5- 7336 mgtto de calefactor a boquilla en culata
- 6- n/d mgtto de botella a tubo de agua metálico
- 7- n/d tubo de agua metálico
- 8- 116 mgtto de bomba de agua a bloque motor: Cortar de rollo MC-116 Ø 8 x 14 mm, longitud 150 mm
- 9- 116 mgtto sobrante de botella a radiador: Cortar de rollo MC-116 Ø 8 x 14 mm, longitud 950 mm
- 10- 3510 botella de expansión  
3607 tapón botella de expansión

## SEAT IBIZA - MALAGA (1984-1993)



**5118**  
mgto de termostato a tubo metálico 1.2-1.5  
r.o. SE-021032170B



**5119**  
mgto inferior radiador 1.2-1.5  
r.o. SE-021117207A



**5120**  
mgto superior radiador 1.2-1.5 carburador  
r.o. SE.021117205C



**5121**  
mgto inferior radiador 1.7 Diesel  
r.o. SE-021117207A



**5122**  
mgto superior radiador 1.7 Diesel  
r.o. SE-021117207C



**7335**  
mgto entrada y salida calefactor 1.2-1.5  
(carburador), r.o.



**7336**  
mgto de calefactor Diesel e inyección  
r.o. SE-021186333C



**7355**  
mgto de bomba a tubo Diesel  
r.o.



**7796**  
mgto superior radiador 1.5 inyección  
r.o. SE-021117205E



**8021**  
mgto desvaporizador 1.5 inyección  
r.o. SE-021004431B



**3002**  
tubo de agua metálico 1.2-1.5 carburador  
r.o. SE-021032103A



**3013**  
tubo de agua metálico 1.5 inyección  
r.o. SE-021032103C



**644** **bocas desiguales**  
racor empalme tubos de calefacción  
r.o. XO-3947619



**691** **bocas iguales**  
racor empalme tubos de calefacción  
XO-3942345



**3510**  
botella de expansión  
r.o. SE-022117100B



**3118**  
tapa de termostato  
r.o. SE-021032200A



**3607**  
tapón botella radiador 0,7 bar  
r.o.

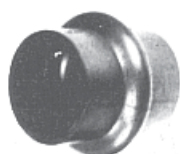

**5110**  
tubo llenado combustible IBIZA  
r.o. SE-138104311A



**7678**  
tubo llenado combustible MALAGA  
r.o. SE-022104311A



**3621**  
tapón llenado aceite motor  
r.o.

# SEAT IBIZA - MALAGA (1984-1993)

## SUSPENSION DELANTERA y SOPORTES DE MOTOR

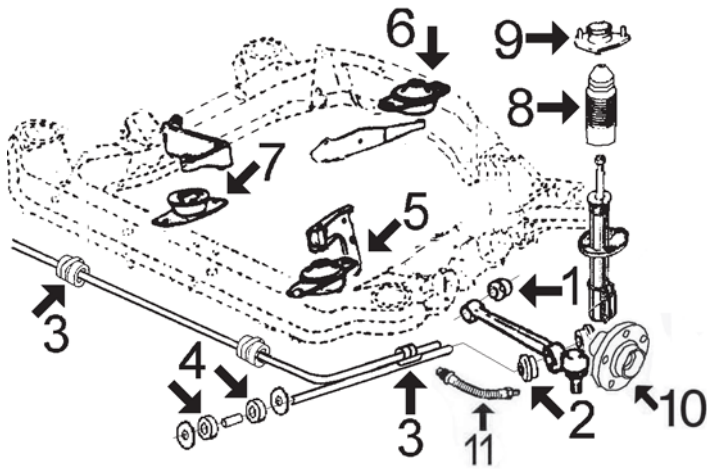

- 1- 269 silentbloc extremo brazo delantero hasta '87
- 976 silentbloc extremo brazo delantero desde '87
- 2- 464 goma central brazo delantero
- 3- 567 goma barra estabilizadora Málaga-Ibiza SXi
- 4- 489 juego de silentblocs tirante brazo hasta '87
- 2324 silentbloc tirante brazo desde '87
- 5- 345 soporte de motor izquierdo todos modelos
- 6- 853 soporte de motor trasero, 1.2-1.5 gasolina
- 698 soporte de motor trasero, 1.7 Diesel
- 7- 306 soporte de motor derecho, 1.2-1.5 gasolina
- 698 soporte de motor derecho, 1.7 Diesel hasta '90
- 937 soporte de motor derecho, 1.7 Diesel desde '90
- 8- 2329 capuchón amortiguador delantero desde '87
- 9- n/d soporte amortiguador delantero hasta '87
- 922 soporte amortiguador delantero desde '87 (con rodamiento de Ø 12 mm)
- 923 soporte amortiguador delantero desde '87 (con rodamiento de Ø 14 mm)
- 10- 90092 buje de rueda delantera
- 11- 96090 latiguillo freno delantero

 <p><b>269</b> silentbloc extremo brazo hasta '87 r.o.SE-141156137A</p>	 <p><b>976</b> silentbloc extremo brazo desde '87 r.o.XO-39552250</p>	 <p><b>464</b> goma central brazo delantero r.o.SE-138156244A</p>
 <p><b>567</b> goma barra estabilizadora r.o.SE-138156235A</p>	 <p><b>489</b> juego silentblocs tirante brazo hasta '87 r.o.SE-132156127A y SE-132156126A</p>	 <p><b>2324</b> silentbloc tirante brazo delantero desde '87 r.o.SE-021156244A</p>
 <p><b>345</b> soporte de motor izquierdo r.o.SE-022154805B</p>	 <p><b>853</b> soporte de motor trasero, 1.2-1.5 gasolina r.o.SE-138154605B</p>	 <p><b>698</b> soporte de motor derecho y trasero 1.7 D r.o.SE-138154605A</p>
 <p><b>306</b> soporte de motor derecho 1.2-1.5 gasolina r.o.SE-138154205A</p>	 <p><b>937</b> soporte de motor derecho 1.7 Diesel d/'90 r.o.SE-021154104B</p>	 <p><b>937</b> soporte de motor derecho 1.7 Diesel d/'90 r.o.SE-021154104B</p>

## SEAT IBIZA - MALAGA (1984-1993)



**2329**  
capuchón amortiguador delantero d/ '87  
r.o.SE-021156212B



**922**  
rodamiento de Ø 12 mm  
soporte amortiguador delantero  
r.o.



**923**  
rodamiento de Ø 14 mm  
soporte amortiguador delantero  
r.o.SE-021156228A



**90002**  
bujes de rueda delantera  
r.o.SE-138140304A



**90501**  
bujes de rueda trasera  
r.o.SE-140900202



**230**  
silentbloc trapecio trasero  
r.o.SE-138156532A



**756**  
goma sujeción amortiguadores traseros  
r.o.SE-127160112A



**443**  
juego cruceta barra cambio  
r.o.SE-022129110AySE-022129114C



**1514E**  
kit rep. transmisión lado rueda  
r.o.SE-127141537A



**1636**  
kit rep. transmisión l/cambio completo con  
rodamiento



**349**  
fuente transmisión lado cambio  
r.o.SE-022141931A



**1257**  
fuente derecho cremallera dirección  
r.o.SE-138162132A



**1258**  
fuente izquierdo cremallera dirección  
r.o.SE-138162131A



**2823**  
soporte cuerpo de inyección SXI  
(Ø15, alt. 15, M-6), r.o. SE-3952110

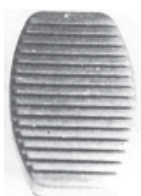

**413**  
cubrepedal freno y embrague  
r.o.



**207**  
soporte tubo de escape  
r.o.SE-138115503A



**165**  
soporte tubo de escape  
r.o.SE-138115514A



**96090**  
latiguillo freno delantero (435 mm)  
r.o.SE022744400A



**96098**  
latiguillo freno trasero (325 mm)  
r.o.SE021744400A



CANALIZACIONES DE AGUA hasta 4/'99

<b>IBIZA</b>	<b>1.05</b>	<b>motor AAU de 45cv</b>	<b>hasta '95</b>
	<b>1.0</b>	<b>motor AER de 50cv</b>	<b>hasta '99</b>
	<b>1.3</b>	<b>motores AAV y 2G de 54 cv</b>	<b>hasta '94</b>
	<b>1.4</b>	<b>motor ABD de 60cv</b>	<b>hasta '96</b>
	<b>1.6</b>	<b>motor ABU de 75cv</b>	<b>hasta '94</b>

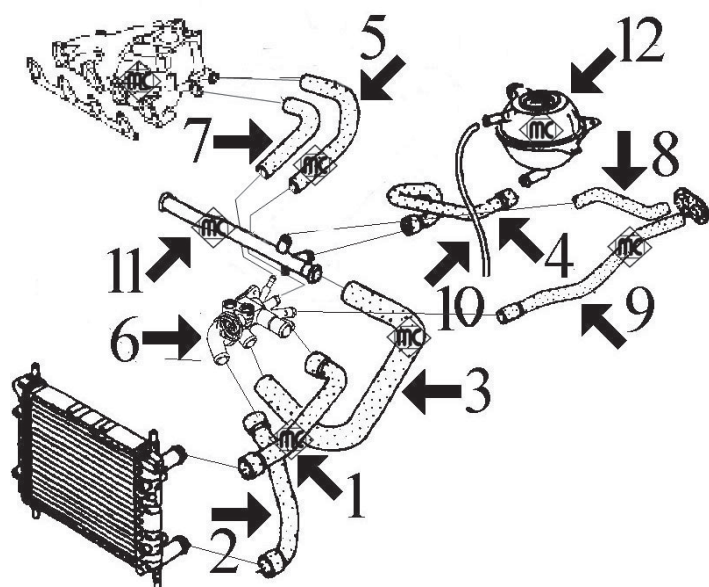

- 1- 8418 mgto superior radiador
- 2- 8401 mgto inferior radiador
- 3- 8409 mgto de racor a tubo rígido
- 4- 8378 mgto de tubo rígido a botella expansión
- 5- 7932 mgto de tubo metálico a colector y carburador, 1.3 motor 2G
- 7968 mgto de caja termostato a colector 1.0-1.05-1.4
- 8844 mgto de caja termostato a colector 1.6
- 6- 3543 caja de termostato
- 3528 tapa de termostato
- 7- 8411 mgto de caja termostato a colector 1.4
- n/d mgto de caja termostato a colector 1.6
- 8- 8397 mgto derecho de calefactor a tubo metálico
- 9- 8393 mgto izquierdo de calefactor a a racor
- 10- 116 mgto de botella a radiador: Cortar de rollo MC-116 Ø 8x14 mm, long. aprox 460 mm
- 11- 3087 tubo de agua (metálico) 1.3 motor 2G
- 3618 tubo de agua (plástico) 1.0-1.05-1.4-1.6 con junta tórica
- 12- 3504 botella de expansión
- 3506 tapón botella de expansión

8415 mgto desvaporizador

<b>IBIZA</b>	<b>1.4</b>	<b>motores AEX-AKV y APQ de 60cv</b>	<b>hasta '99</b>
	<b>1.4</b>	<b>motor AFH-16v de 100cv</b>	<b>hasta '99</b>
	<b>1.4</b>	<b>motor ANX de 54 cv</b>	<b>hasta '99</b>
	<b>1.6</b>	<b>motores AEE y ALM de 75cv</b>	<b>hasta '99</b>

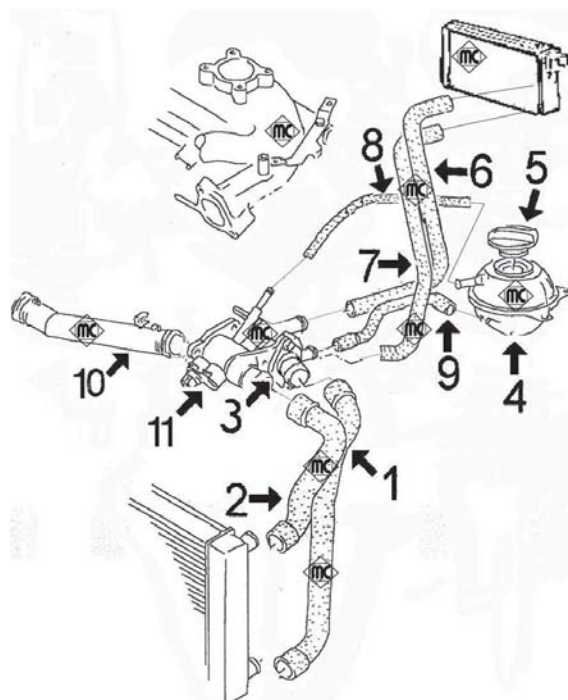

- 1- 8834 mgto inferior radiador desde '95
- 2- 8400 mgto superior radiador desde '95
- 3- 3592 kit de termostato completo con tapa y junta
- 3541 tapa de termostato
- 4- 3504 botella de expansión
- 5- 3506 tapón botella de expansión
- 6- 8845 mgto entrada agua a calefactor
- 7- 8846 mgto retorno agua de calefactor
- 8- 116 mgto sobrante de botella a mgto inferior y caja de termostato: cortar de rollo MC-116 Ø 8x14 mm, long. aprox. 350 mm
- 9- 8822 mgto de cuerpo termostato a botella
- 10- 3625 tubo de agua (plástico) con juntas tóricas
- 11- 3615 cuerpo de termostato completo con termostato, tapa y accesorios

8811 mgto desvaporizador

CANALIZACIONES DE AGUA hasta 4/'99

<b>IBIZA</b>	<b>1.6</b>	<b>motor 1F de 75cv</b>	<b>hasta '99</b>
	<b>1.6</b>	<b>motor AFT de 100cv</b>	<b>hasta '99</b>
	<b>1.8</b>	<b>motores ABS-ACC y ADZ de 90cv</b>	<b>hasta '99</b>
	<b>1.8/16v</b>	<b>motor ADL de 129cv</b>	<b>hasta '96</b>

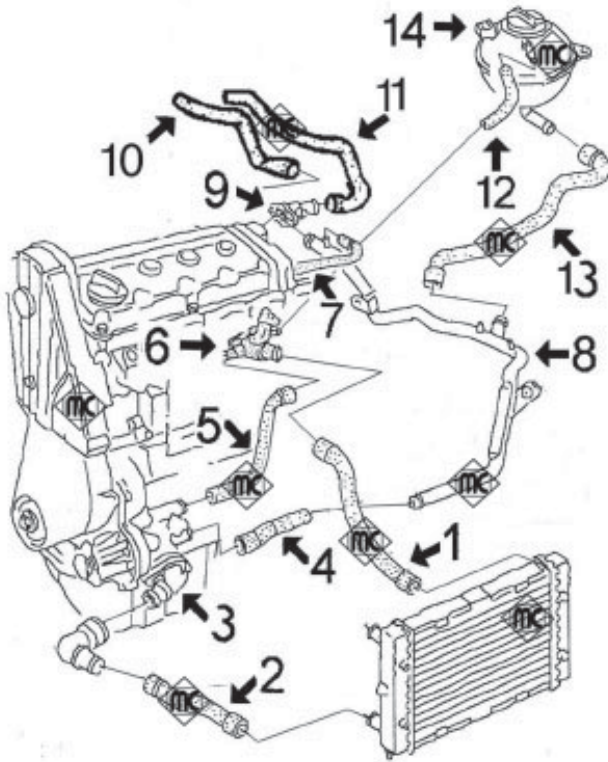

- 1- 8404 mgto superior radiador 1.6(75cv)-1.8 sin aire ac.
- 8398 mgto superior radiador 1.6(75cv)-1.8 con aire ac.
- n/d mgto superior radiador 1.8/16v hasta 11/'95
- 8392 mgto superior radiador 1.8/16v desde 11/'95
- n/d mgto superior radiador 1.6(100cv)
- 2- 8403 mgto inferior radiador 1.6(75cv) y 1.8
- 8402 mgto inferior radiador 1.6(75cv)-1.6(100cv)-1.8 y 1.8/16v con aire acondicionado
- 8406 mgto inferior radiador 1.6(100cv) y 1.8/16v sin aire acondicionado
- 3- 3537 tapa de termostato
- 3667 tapa de termostato completa con boquilla a 90°
- 4- 8386 mgto de bomba de agua a tubo
- 5- 8383 mgto de bomba de agua a culata
- 6- 3522 brida en culata conexión mgto
- 7- 8391 mgto de tubo metálico a colector
- 8- 3084 tubo de agua metálico 1.6-1.8 (salvo 16v)
- 3095 tubo de agua metálico 1.8-16v
- 9- 3517 boquilla en culata 1.6(75cv)-1.8-1.8/16v
- 10- 8395 mgto de tubo metálico a calefactor
- 11- 8396 mgto de culata a calefactor
- 12- 116 mgto de sobrante de botella a radiador, cortar de rollo MC-116 Ø8x15 mm longitud 750 mm
- 13- 8378 mgto de tubo metálico a botella
- 14- 3504 botella de expansión con sensor de nivel
- 3506 tapón botella de expansión
  
- 8224 mgto desvaporizador (sin catalizador)
- 8225 mgto desvaporizador (con catalizador)
- 8226 mgto desvaporizador

<b>IBIZA</b>	<b>2.0</b>	<b>motores 2E y AGG de 115cv</b>	<b>hasta '99</b>
	<b>2.0/16v</b>	<b>motor ABF de 150cv</b>	<b>hasta '99</b>

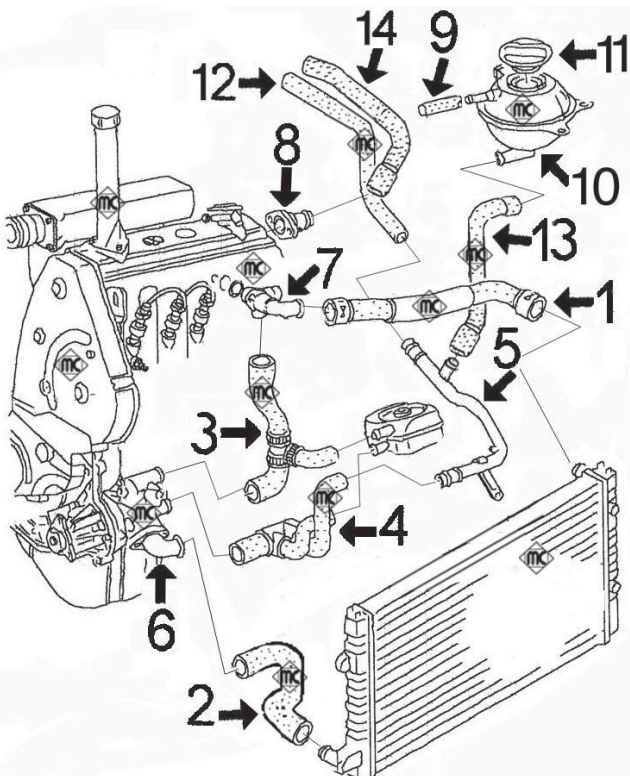

- 1- 8398 mgto superior radiador 2.0 hasta '96
- 8417 mgto superior radiador 2.0 desde '96
- n/d mgto superior radiador 2.0/16v (3 vias)
- 2- 8406 mgto inferior radiador 2.0 hasta '96 sin aire ac.
- 8402 mgto inferior radiador 2.0 hasta '96 con aire ac.
- 8399 mgto inferior radiador 2.0 desde '96 y 2.0/16v
- 3- 8394 mgto de bomba a brida en culata 2.0
- 8414 mgto de bomba a brida en culata 2.0/16v
- 4- 8384 mgto de bomba a intercambiador y a tubo metálico 2.0
- 5- 3084 tubo de agua metálico 2.0
- 3095 tubo de agua metálico 2.0/16v
- 6- 3537 tapa de termostato
- 3667 tapa de termostato completa con boquilla a 90°
- 7- 3522 brida en culata conexión mgto 2.0
- n/d brida en culata conexión mgto 2.0/16v
- 8- 3517 boquilla en culata (lateral)
- 3583 boquilla en culata (lateral) 2.0/16v.
- 9- 116 mgto de sobrante de botella a radiador, cortar de rollo MC-116 Ø8x15 mm longitud 750 mm
- 10- 3504 botella de expansión
- 11- 3506 tapón botella de expansión
- 12- 8395 mgto de tubo metálico a calefactor
- 13- 8378 mgto de tubo metálico a botella de expansión
- 14- 8396 mgto de culata a calefactor
  
- 8228 mgto desvaporizador de gases 2.0
- 8229 mgto desvaporizador de gases 2.0

CANALIZACIONES DE AGUA hasta 4/'99

IBIZA	1.9 Diesel 1.9 TurboD 1.9 SDi 1.9 TDi-90 1.9 TDi-110	motores 1Y de 64cv motor AAZ de 75cv motor AEY de 64cv motores AHU y 1Z de 90cv motor AFN de 110cv	hasta '97 hasta '97 hasta '99 hasta '99 hasta '99
-------	--	--	---

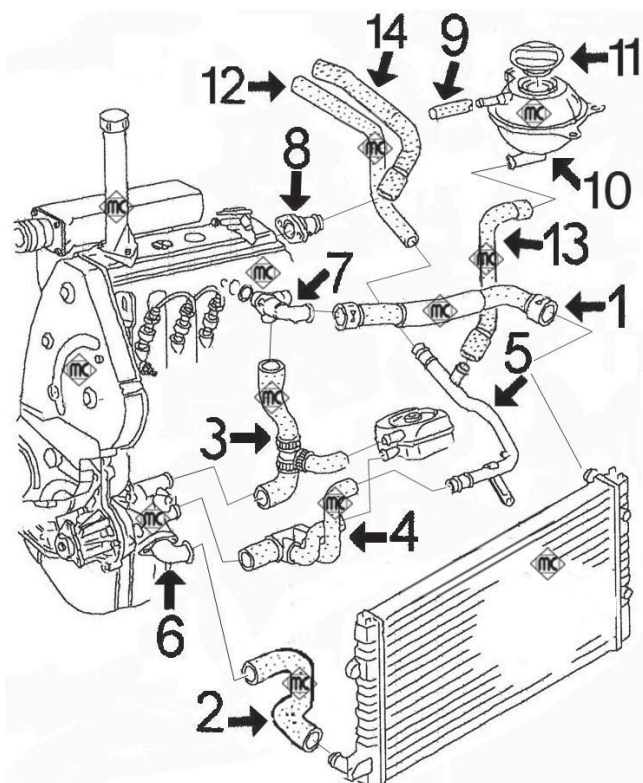

- 1- 8398 mgto superior radiador Diesel y TurboD  
8417 mgto superior radiador SDi y TDi
  - 2- 8406 mgto inferior radiador Diesel  
8402 mgto inferior radiador TurboD  
8399 mgto inferior radiador SDi y TDi
  - 3- 8382 mgto de bomba a brida en culata
  - 4- 8384 mgto de bomba a intercambiador y a tubo metálico
  - 5- 3084 tubo de agua metálico Diesel y TurboDiesel  
3094 tubo de agua metálico SDi-TDi
  - 6- 3537 tapa de termostato  
3667 tapa de termostato completa con boquilla a 90°
  - 7- 3527 brida en culata conexión mgts Diesel y TurboD  
3542 brida en culata conexión mgts SDi-TDi
  - 8- 3517 boquilla en culata
  - 9- 116 mgto de sobrante de botella a radiador, cortar de rollo MC-116 Ø 8x15 mm longitud 750 mm
  - 10- 3504 botella de expansión
  - 11- 3506 tapón botella de expansión
  - 12- 8395 mgto de tubo metálico a calefactor
  - 13- 8378 mgto de tubo metálico a botella de expansión
  - 14- 8396 mgto de culata a calefactor
- 8385 mgto desvaporizador de gases



CANALIZACIONES DE AGUA desde 4/'99

<b>IBIZA</b>	<b>1.0</b>	<b>motores ALD-ANV-AST-AUC</b>	<b>desde '99</b>
	<b>1.4</b>	<b>motores AKK-ANW-AUD</b>	<b>desde '99</b>
	<b>1.4/16v</b>	<b>motores APE-AQQ-AUA-AUB</b>	<b>desde '99</b>
	<b>1.6</b>	<b>motor ALM de 75cv</b>	<b>desde '99</b>

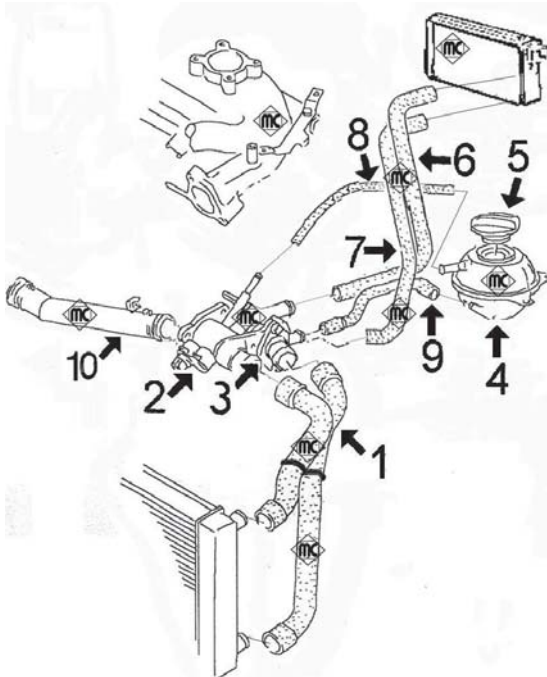

- 1- 9083 mgto superior e inferior radiador
- 2- 3615 cuerpo de termostato completo con termostato, tapa y accesorios
- 3- 3592 kit de termostato completo con tapa y junta  
3541 tapa de termostato
- 4- 3504 botella de expansión
- 5- 3506 tapón botella de expansión
- 6- 8845 mgto entrada agua a calefactor
- 7- 8846 mgto retorno agua de calefactor
- 8- 116 mgto sobrante de botella a mgto inferior y caja de termostato: cortar de rolo MC-116 Ø 8x14 mm, long. aprox. 350 mm
- 9- 8822 mgto de cuerpo termostato a botella
- 10- 3625 tubo de agua (plástico) con juntas tóricas
  
- 8811 mgto desvaporizador

<b>IBIZA</b>	<b>1.6</b>	<b>motores AEH-AKL-APF (100cv-102cv)</b>	<b>desde '99</b>
	<b>1.8-20v</b>	<b>motores AQX-AYP (155cv)</b>	<b>desde '99</b>

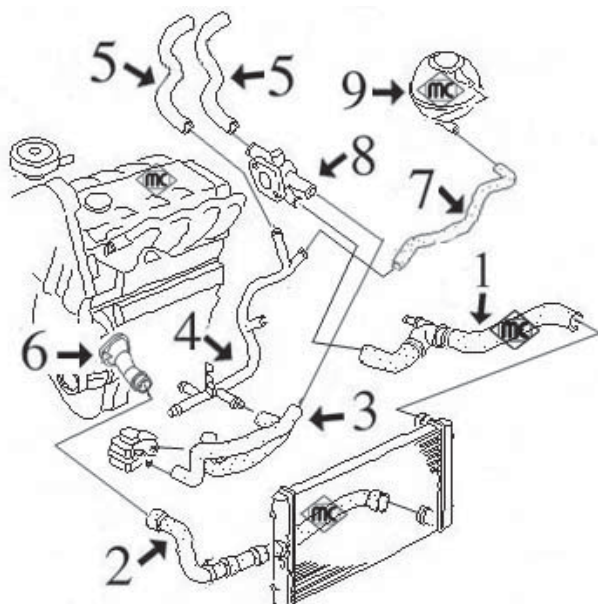

- 1- 9085 mgto superior radiador completo 1.6  
9086 mgto superior radiador completo 1.8
- 2- 9084 mgto inferior radiador 1.6-1.8
- 3- 9081 mgto doble a intercambiador 1.6  
9082 mgto doble a intercambiador 1.8
- 4- 3188 tubo de agua metálico 1.6  
3189 tubo de agua metálico 1.8
- 5- 9087 juego mgtos entrada/salida calefactor
- 6- 3597 boquilla entrada agua a bloque motor
- 7- 9090 mgto de tubo metálico a botella 1.6  
n/d mgto de tubo metálico a botella 1.8
- 8- 3598 caja de agua (plástico) en culata 1.6  
3599 caja de agua (plástico) en culata 1.8 hasta '00  
3600 caja de agua (plástico) en culata 1.8 desde '00
- 9- 3504 botella de expansión  
3506 tapón botella de expansión



CANALIZACIONES DE AGUA desde 4/'99

IBIZA	1.9 SDi 1.9 TDi-90 cv 1.9 TDi-110cv	motores AQM-AGP de 68cv motores AGR-ALH motor ASV	desde '99 desde '99 desde '99
-------	---	---	-------------------------------------

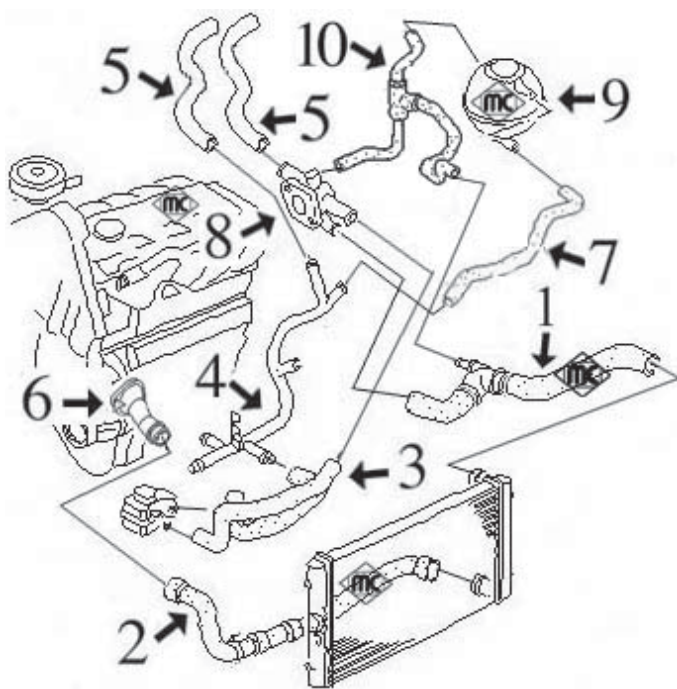

- 1- 9085 mgto superior radiador completo
- 2- 9084 mgto inferior radiador
- 3- 9080 mgto doble a intercambiador
- 4- 3186 tubo de agua metálico
- 5- 9088 juego mgto entrada/salida calefactor
- 6- 3590 boquilla entrada agua a bloque motor
- 7- 9090 mgto de tubo metálico a botella
- 8- 3591 caja de agua (plástico) en culata
- 9- 3504 botella de expansión  
3506 tapón botella de expansión
- 10- 9089 mgto de botella a caja de agua en culata

TUBOS DESVAPORIZADORES 1.9D - TD - TDi - SDi (hasta 5/'99)

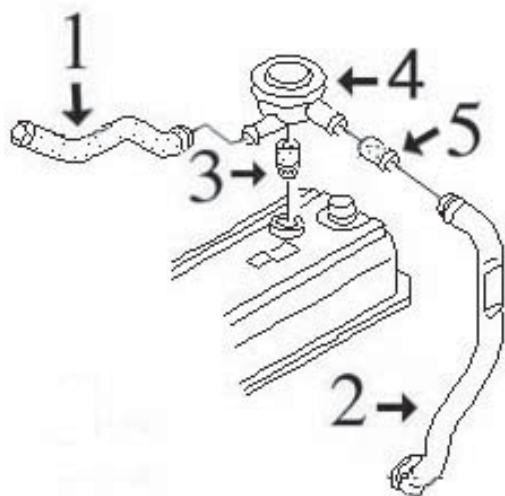

- 1- 8895 mgto de válvula desvaporizadora 1.9TDi  
8385 mgto de válvula desvaporizadora 1.9D
- 2- 3644 tubo plástico de válvula a cárter
- 3- 2669 junta válvula desvaporizadora
- 4- 3719 válvula desvaporizadora
- 5- 8385 mgto de válvula desvaporizadora 1.9D-TD (no TDi!)

**SEAT IBIZA - CORDOBA 1993-2002**



**7932**  
mgto de tubo metálico a colector 1.3 "2G"  
r.o.030121054



**7968**  
mgto de tubo metálico a colector 1.05-1.3  
1.4-1.6,r.o.030121054P-032121054A



**8085**  
mgto desvaporizador 1.3  
r.o.030103493M



**8224**  
mgto desvaporizador 1.6  
r.o.051103493A-048103493A



**8225**  
mgto desvaporizador 1.6  
r.o.051103493



**8226**  
mgto desvaporizador 1.8  
r.o.050103493A



**8228**  
mgto desvaporizador 2.0  
r.o.037103493AB-037103211



**8229**  
mgto desvaporizador 2.0  
r.o.037103493P



**8319**  
mgto desvaporizador 1.05  
r.o.030103493N-6K0103493



**8377**  
mgto depresor servofreno todos mods.  
r.o.321611939E



**8378**  
mgto de tubo metálico a botella  
r.o.1H0121109-1H0121109A



**8382**  
mgto de bomba a brida en culata D-TD-TDi y SDi,r.o.028121053Q/S/L/P



**8383**  
mgto de bomba a brida en culata 1.6-1.8  
r.o.037121053H



**8384**  
mgto de bomba a intercambiador y tubo TD-TDi y SDi,r.o.037122058B



**8385**  
mgto desvaporizador D-TD-TDi y SDi  
r.o.028103493E



**8386**  
mgto de bomba a tubo metálico 1.6-1.8  
r.o.037121063A



**8391**  
mgto de tubo metálico a colector 1.6-1.8  
r.o.051121056



**8393**  
mgto calefactor 1.05-1.3-1.4-1.6  
r.o.1H0819373A



**8394**  
mgto de bomba a brida en culata 2.0  
r.o.037121053G/J-037121036























**8395**  
mgto calefactor 1.6-1.8-2.0-D-TD-TDi  
r.o.1H0819373C



**8396**  
mgto calefactor 1.6-1.8-2.0-D-TD-TDi  
r.o.1H0819371

## SEAT IBIZA - CORDOBA 1993-2002

 <p><b>8397</b> mgto calefactor 1.05-1.3-1.4-1.6 r.o. 1H0819371A</p>	 <p><b>8398</b> mgto superior radiador 1.6-1.8-D-TD r.o. 1H0121101B-6K0121101B</p>	 <p><b>8399</b> mgto inferior radiador 2.0 y TDi r.o. 6K0121051K/H</p>
 <p><b>8400</b> mgto superior radiador 1.05-1.3-1.4-1.6 r.o. 6K0121101</p>	 <p><b>8401</b> mgto inferior radiador 1.05-1.3-1.4-1.6 r.o. 6K0121051</p>	 <p><b>8402</b> mgto inferior radiador 1.6-1.8-2.0-TD r.o. 6K0121051C</p>
 <p><b>8403</b> mgto inferior radiador 1.6-1.8 r.o. 6K0121051A</p>	 <p><b>8404</b> mgto superior radiador 1.6-1.8 r.o. 6K0121101A</p>	 <p><b>8406</b> mgto inferior radiador 2.0 y Diesel r.o. 1H0121051B</p>
 <p><b>8409</b> mgto de bomba a tubo 1.05-1.3-1.4-1.6 r.o. 032121063</p>	 <p><b>8411</b> mgto de tubo metálico a colector 1.05-1.3-1.6, r.o. 030121056C/B</p>	 <p><b>8414</b> mgto de bomba a brida en culata 2.0-16v r.o. 037121053K</p>
 <p><b>8415</b> mgto desvaporizador 1.6 hasta '94 r.o. 032103493E-030103493AH</p>	 <p><b>8417</b> mgto superior radiador TDi-110CV y SDi r.o. 6K0121101G</p>	 <p><b>8812</b> mgto desvaporizador 1.6 desde '94- r.o.</p>
 <p><b>8822</b> mgto de caja termostato a botella 1.4-1.6 r.o.</p>	 <p><b>8834</b> mgto inferior radiador 1.4-1.6 desde '95 r.o.</p>	 <p><b>8844</b> mgto caja termostato a colector 1.6 hasta '95, r.o.</p>
 <p><b>8845</b> mgto entrada a calefactor 1.4-1.6 desde '95 r.o.</p>	 <p><b>8846</b> mgto retorno calefactor 1.4-1.6 desde '95 r.o.</p>	 <p><b>8895</b> mgto desvaporizador 1.9TDi-SDi r.o.</p>



SEAT IBIZA - CORDOBA 1993-2002

**¡Nuevo!**



**9080**  
mgto de intercambiador a tubo 1.9SDi-TDi '99-'02, r.o.

**¡Nuevo!**



**9081**  
mgto doble intercambiador 1.6-100CV r.o.

**¡Nuevo!**



**9082**  
mgto doble intercambiador 1.8-20v r.o.

**¡Nuevo!**



**9083**  
mgto superior/inferior 1.0-1.4.1.6 '99-r.o.

**¡Nuevo!**



**9084**  
mgto inferior radiador 1.6-100CV '99-r.o.

**¡Nuevo!**



**9085**  
mgto sup radiador 1.6/100CV-1.9SDi-TDi '99-, r.o.

**¡Nuevo!**



**9086**  
mgto sup radiador 1.8-20v '99-r.o.

**¡Nuevo!**



**9087**  
jgo mgto calefactor 1.6-100CV '99-r.o.

**¡Nuevo!**



**9088**  
jgo mgto calefactor 1.9 SDi-TDi '99-r.o.

**¡Nuevo!**



**9089**  
mgto de culata a botella 1.9SDi-TDi r.o.

**¡Nuevo!**



**9090**  
mgto de tubo metálico a botella 1.9TDi-SDi r.o.



**3504**  
botella de expansión r.o. 1H0121407A/C



**3506**  
tapón botella de expansión r.o. 357121321A-1H0121321A



**3517**  
boquilla en culata empalme tubo calefact. todos salvo 2.0/16v, r.o. 037121145



**3522**  
brida en culata 1.6-1.8-2.0 r.o. 037121133F-037121132E-037121132G

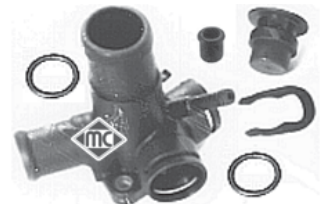

**3527**  
brida en culata D-TD r.o. 068121133AB/AE



**3528**  
tapa de termostato 1.05-1.3-1.4 todos y 1.6 hasta '94, r.o. 030121121B



**3537**  
tapa de termostato 1.6 desde '94, 1.8-2.0-D-TD y TDi, r.o. 037121121A+1H0121687



**3540**  
kit tapón cierre alojamiento sensores r.o. 357121140+032121142+N90316802



SEAT IBIZA - CORDOBA 1993-2002



**3541**

tapa de termostato 1.0-1.4-1.6 desde '95  
r.o.032121121B-J



**3542**

brida en culata SDi-TDi  
r.o.028121132A



**3543**

caja de termostato 1.0-1.05-1.3-1.4(h/'95) y  
1.6(ABU),r.o.030121117L-030121117M



**3583**

boquilla en culata (lateral) 2.0-16v  
r.o.027121145B



**3590**

tapa de termostato 1.9 TDi-SDi desde '99  
r.o.038121121



**3591**

tapa en culata (lateral) TDi-SDi desde '99  
r.o.038121132C



**3592**

kit completo de termostato, tapa y junta 1.0-  
1.4,r.o.032121121J+032121110B



**3597**

tapa de termostato 1.6-1.8-2.0 desde '99  
r.o.06A121121C



**3598**

tapa en culata (lateral) 1.6-2.0 desde '99  
r.o.06A121132



**3599**

tapa en culata (lateral) 1.8 desde '99 hasta '00  
r.o.06A121132Q



**3600**

tapa en culata (lateral) 1.8 desde '00  
r.o.06A121132A-06A121132G/D

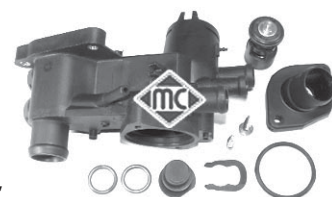

**3615**

cuerpo de termostato 1.0-1.4-1.6 completo  
con termostato, tapa y accesorios

**¡Nuevo!**



**3667**

tapa de termostato 1.6-1.8-2.0-D-TD-TDi  
completa con codo,037121121A+037121619



**2669**

junta válvula desvaporizadora  
r.o.028103500



**2845**

soporte radiador  
r.o.6K0121267



**3087**

tubo de agua metálico 1.3 motor 2G  
r.o.052121071Q-030121065A



**3084**

tubo de agua metálico 1.6-1.8-2.0-D-TD  
r.o.037121065K/L/G/H



**3094**

tubo de agua metálico TDi  
r.o.028121065K/T



**3095**

tubo de agua metálico 2.0-16v  
r.o.037121065J



**3186**

tubo de agua metálico 1.9 TDi-SDi '99-'02  
r.o.



**3188**

tubo de agua metálico 1.6-100CV  
r.o.

SEAT IBIZA - CORDOBA 1993-2002

**¡Nuevo!**



**3189**  
tubo de agua metálico 1.8-20v. desde '99  
r.o.



**3618**  
tubo de agua (plástico) con juntas tóricas  
1.4-1.6 hasta '95, r.o. 030121065J



**3625**  
tubo de agua (plástico) con juntas tóricas  
1.4-1.6 desde '95, r.o. 032121065D

**¡Nuevo!**



**3644**  
tubo desvaporizador 1.9D-TD-TDi-SDi  
r.o. 028103491J

**¡Nuevo!**



**3719**  
válvula desvaporizadora 1.9D-TD-TDi  
r.o. 028129101D

**¡Nuevo!**



**3722**  
tubo desvaporizador 1.9TDi desde 5/'99  
r.o. 038103493P



CANALIZACIONES de AIRE de ALTA PRESION INTERCOOLER-TURBO:

**IBIZA 1.9 Diesel motores TDi desde 12/'96 a 6/'99  
(AHU-1Z-AFN-ALE)**

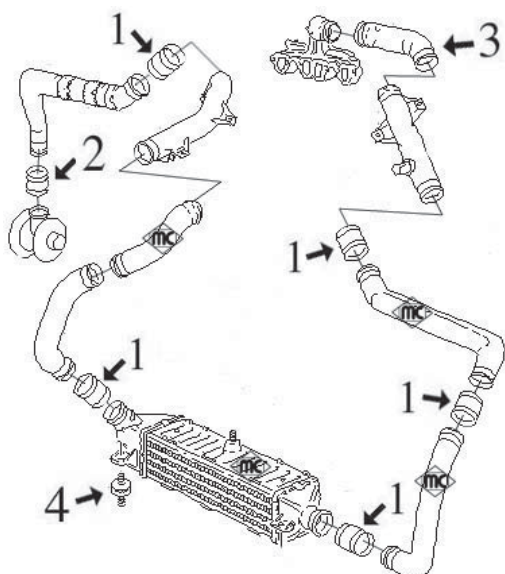

- 1- 9061 tubo flexible de empalme
- 2- 9062 tubo flexible de empalme
- 3- 9060 tubo flexible de colector de aspiración a tubo
- 4- n/d soporte elástico intercooler

**IBIZA 1.9 Diesel motores TDi desde 6/'99 a 5/'02:  
(ALH-ASV-AGR)**

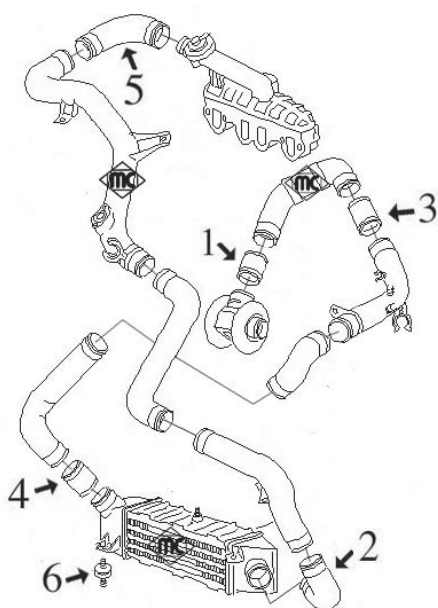

- 1- 9062 tubo flexible de empalme
- 2- 9063 tubo flexible a intercooler
- 3- 9061 tubo flexible de empalme
- 4- 9064 tubo flexible de empalme
- 5- 9065 tubo flexible de colector de aspiración a tubo rígido
- 6- n/d soporte elástico intercooler

**SEAT IBIZA - CORDOBA 1993-2002**

<p><b>¡Nuevo!</b></p>  <p><b>9060</b> tubo flexible de colector a tubo r.o. 1H0145838G</p>	<p><b>¡Nuevo!</b></p>  <p><b>9061</b>      <b>Ø 50x60 largo 58 mm</b> tubo flexible de alta presion de empalme r.o. 1H0145834E</p>	<p><b>¡Nuevo!</b></p>  <p><b>9062</b>      <b>Ø 35x45 largo 58 mm</b> tubo flexible de alta presion de empalme r.o. 3A0145972A</p>
<p><b>¡Nuevo!</b></p>  <p><b>9063</b> tubo flexible a intercooler r.o. 6K0145832C</p>	<p><b>¡Nuevo!</b></p>  <p><b>9064</b>      <b>Ø 60x70 largo 58 mm</b> tubo flexible de alta presion de empalme r.o. 1J0145834A</p>	<p><b>¡Nuevo!</b></p>  <p><b>9065</b> tubo flexible de colector a tubo rígido r.o. 6K0145838B</p>

**CANALIZACIONES de COMBUSTIBLE:**

**IBIZA      1.6-75 CV motor 1F (hasta '96)**  
**1.8-90CV    motores ABS-ACC-ADZ (hasta '99)**

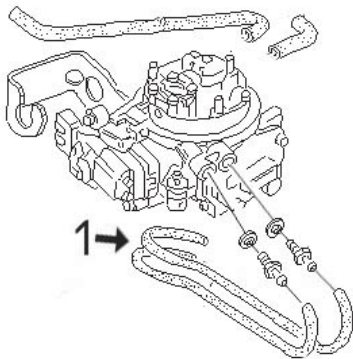

**1- 9062 juego de tubos entrada/salida gasolina a unidad de inyección**

<p><b>¡Nuevo!</b></p>  <p><b>9146</b> jgo tubos entrada/salida gasolina a unidad de inyección, r.o. 6K0133699B+6K0133723B</p>		
--	--	--



**SUSPENSION DELANTERA y SOPORTES DE MOTOR:**  
**todos modelos desde '93 hasta 5/'99:**

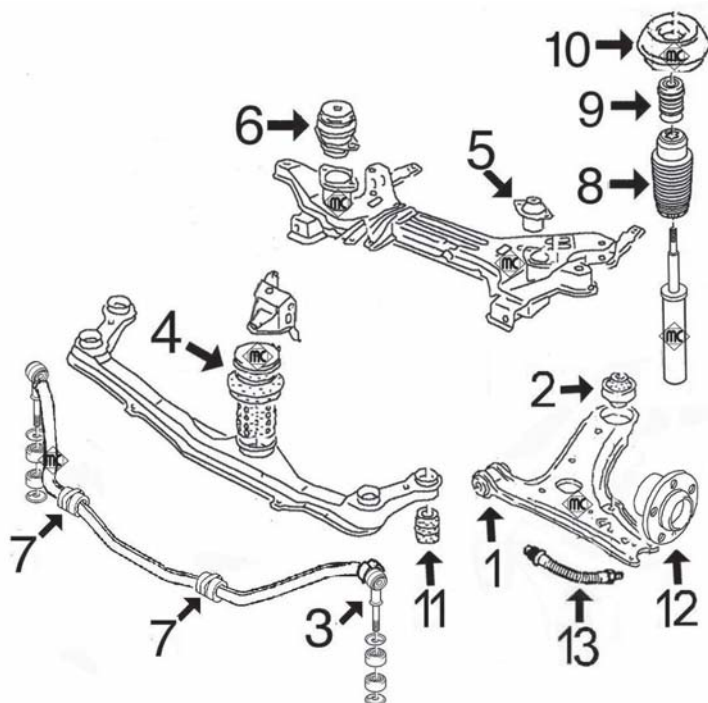

- 1- 542 silentbloc anterior trapecio delantero
- 2- 2660 silentbloc posterior trapecio delantero
- 3- 646 bieleta puntal barra estabilizadora hasta '94
- 2852 bieleta puntal barra estabilizadora desde '94
- 4- 2685 soporte motor delantero
- 5- 2627 soporte motor trasero izquierdo 1.0-1.05-1.3-1.4 y 1.6(75cv) y SDi
- 846 soporte motor trasero izquierdo 1.6-1.8-2.0-D y TD hasta '95
- 4362 soporte motor trasero izquierdo 1.6-1.8-2.0-D y TD desde '95
- 4366 soporte motor trasero izquierdo 1.9TDi
- 6- 2686 soporte motor trasero derecho
- 7- 917 goma para barra estabilizadora de Ø 18 mm
- 4266 goma para barra estabilizadora de Ø 20 mm
- 8- 4324 capuchón amortiguador delantero
- 9- 4254 tope de amortiguador hasta '99 (poliuretano)
- 10- 896 soporte amortiguador delantero hasta '94
- 2812 soporte amortiguador delantero desde '94 hasta '99
- 4128 rodamiento soporte amortiguador desde '94
- 11- 2444 silentbloc soporte travesia delantera
- 12- 90073 buje rueda delantera sin ABS
- 90035 buje rueda delantera con ABS
- 13- 96124 latiguillo freno delantero (485 mm)

**SUSPENSION DELANTERA y SOPORTES DE MOTOR:**  
**todos modelos desde 5/'99:**

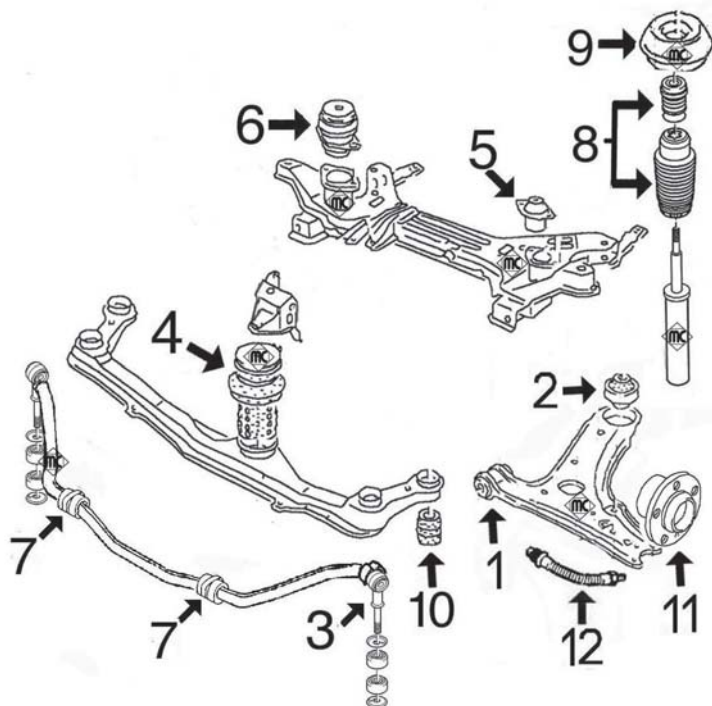

- 1- 542 silentbloc anterior trapecio delantero
- 2- 2660 silentbloc posterior trapecio delantero
- 3- 2852 bieleta puntal barra estabilizadora
- 4- 2685 soporte motor delantero
- 5- 2627 soporte motor trasero izquierdo 1.0-1.4/8v-1.6(75cv) y 1.9SDi
- 4362 soporte motor trasero izquierdo 1.6-1.8-2.0-1.4/16v
- 4366 soporte motor trasero izquierdo 1.9TDi
- 6- 2686 soporte motor trasero derecho
- 7- 917 goma para barra estabilizadora de Ø 18 mm
- 4266 goma para barra estabilizadora de Ø 20 mm
- 8- 4765 juego de fuelle amortiguador y tope de poliuretano
- 9- 4788 soporte amortiguador delantero desde '99 completo con rodamiento
- 4789 rodamiento soporte amortiguador
- 10- 2444 silentbloc soporte travesia delantera
- 11- 90073 buje rueda delantera sin ABS
- 90035 buje rueda delantera con ABS
- 12- 96124 latiguillo freno delantero (485 mm)

SUSPENSION TRASERA:

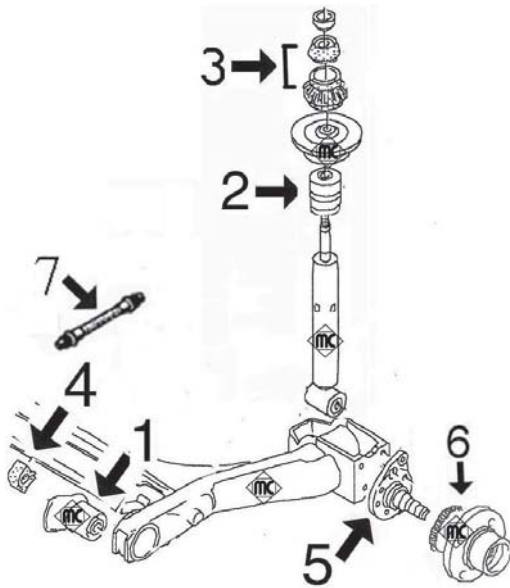

- 1- 2839 silentbloc brazo suspensión trasero hasta 6/'99
- 4907 silentbloc brazo suspensión trasero desde 6/'99
- 2- 4352 tope poliuretano amortiguador trasero
- 3- 4320 jgo. soportes amortiguador trasero
- 4- 2824 goma barra estabilizadora
- 5- 90516 mangueta rueda trasera (dcha. e izqda.), freno de tambor sin ABS hasta '98
- 90539 mangueta rueda trasera izquierda, tambor con ABS hasta '98
- 90540 mangueta rueda trasera derecha, tambor con ABS hasta '98
- 90541 mangueta rueda trasera izquierda, freno de disco hasta '98
- 90542 mangueta rueda trasera derecha, freno de disco hasta '98
- 6- 90525 buje rueda trasera desde '98 (con rodamiento)
- 7- 96126 latiguillo freno trasero (160 mm)

**SEAT IBIZA - CORDOBA 1993-2002**



**542**  
silentbloc anterior trapecio delantero  
r.o.357407182



**646**  
bieleta puntal barra estabilizadora hasta '94  
r.o.191411315

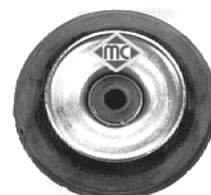

**896**  
soporte amortiguador delantero hasta '94  
r.o.191412329

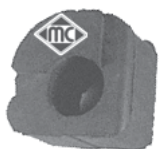

**917**  
goma para barra estabilizadora de Ø 18 mm  
r.o.191411314



**2444**  
silentbloc sub-chasis delantero  
r.o.191199233



**846** vaso Ø 64 mm  
soporte motor trasero izquierdo 1.6-1.8-2.0-D y TD hasta '95, r.o. 191199402



**2627**  
soporte motor trasero izquierdo 1.0-1.05-1.3-1.4-1.6(75cv) y SDi, r.o. 191199381A



**2660**  
silentbloc anterior trapecio delantero (17x60x25x41) r.o. 191407181D



**2685**  
soporte motor delantero  
r.o.1H0199609F/E



**2686**  
soporte motor trasero derecho  
r.o.1H0199262A/E/F



**2812** con rodamiento  
soporte amortiguador delantero desde '94  
r.o.357412331A

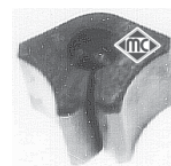

**2824**  
goma barra estabilizadora trasera  
r.o.871511423



**2839**  
silentbloc brazo tras. suspensión hasta '99  
r.o.6N0501541D

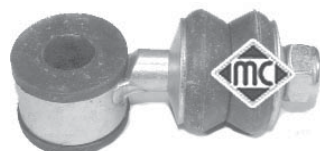

**2852**  
bieleta puntal barra estabilizadora desde '94  
r.o.191411315A



**4128**  
rodamiento soporte amortiguador delantero desde '94, r.o. 1J0412249



**4254**  
tope poliuretano amortiguador delantero hasta '99, r.o. 357412303F



**4266**  
goma para barra estabilizadora de Ø 20 mm  
r.o.1H0411314



**4320**  
jgo. soportes amortiguador trasero  
r.o.191512335+191512333



**4324**  
capuchón amortiguador delantero hasta '99  
r.o.357413175A



**4652**  
tope poliuretano amortiguador trasero  
r.o.

SEAT IBIZA - CORDOBA 1993-2002



**4362** vaso Ø 73 mm  
soporte motor trasero izquierdo 1.6-1.8-2.0-D y TD desde '95, r.o. 3A0199402B



**4366**  
soporte motor trasero izquierdo 1.9TDi  
r.o. 357199381C

**¡Nuevo!**

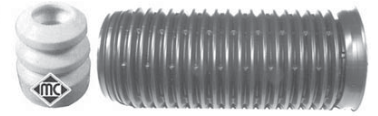

**4765**  
juego fuelle amortiguador y tope poliuretano desde '99, ro. 6N0413175A+6N0412303A

**¡Nuevo!**



**4788**  
soporte amortiguador delantero desde '99 completo con rodamiento, r.o. 6N0412331E

**¡Nuevo!**



**4789**  
rodamiento amortiguador delant. desde '99 r.o. 6N0412249C

**¡Nuevo!**



**4907**  
silentbloc brazo trasero suspensión d/ '99 r.o. 6K0501541A



**90073**  
buje rueda delantera sin ABS  
r.o. 357407615



**90035**  
buje rueda delantera con ABS  
r.o. 357407613B



**90516**  
buje rueda trasera freno tambor sin ABS hasta '98 (**dcha. e izqda.**), r.o. 357501117



**90539**  
mangueta rueda trasera **izquierda**, tambor con ABS hasta '98, r.o. 333501117A



**90540**  
mangueta rueda trasera **derecha**, tambor con ABS hasta '98, r.o. 333501118A



**90541**  
mangueta rueda trasera **izquierda**, freno de disco hasta '98, r.o. 333501117



**90542**  
mangueta rueda trasera **derecha**, freno de disco hasta '98, r.o. 333501118



**90525**  
buje de rueda trasera **con rodamiento** desde '98, r.o. 6X0598477



**96124**  
latiguillo freno delantero (485 mm)  
r.o. 1H0611701



**96126**  
latiguillo freno trasero (160 mm)  
r.o. 1H0611775



SEAT IBIZA - CORDOBA 1993-2002

**3724**  
juego reparación rótula palanca de cambio  
r.o. 191711251A



**2841**  
juego reparación palanca de cambio  
r.o. 1H0711173+191711590A



**4361**  
guía soporte barra cambio  
r.o. 1H0711083



**947** largo 74 mm  
bieleta selector de velocidades hasta '94  
1.8-2.0-D-TD, r.o. 191711595A



**2879** largo 60 mm  
bieleta selector de velocidades desde '94  
1.6-1.8-2.0-D-TD-TDi, r.o. 1H0711595



**2878**  
varilla selector de velocidades (excepto  
1.05-1.3 y 1.4), r.o. 1H0711574



**4141**  
péndulo selector velocidades TDi hasta 9/'97  
r.o. 1L0711051



**4360**  
péndulo selector velocidades TDi desde  
9/'97 hasta '99, r.o. 1H0711051B



**3691**  
articulación cambio 1.9TDi y 2.0-16v  
r.o. 1J0711256



**4902**  
articulación cambio 1.0-1.3-1.4-1.6  
hasta '99, r.o. 191711233





**2854**  
tope cable embrague  
r.o. 1H0798303A



**4749**  
guía embrague con retén 1.9D-TD-TDi y  
2.0-16v, r.o. 02A141180A





**4903**  
guía embrague 1.05-1.3-1.4-1.6  
r.o. 085141181

**4772**  
juego palanca de desembrague 1.6-1.8-2.0-  
1.9DyTD, r.o. 02K141709A+020141723C



**4906**  
varilla accionamiento embrague (341 mm)  
r.o. 020141741B

**1359** **1359-E**  
kit fuelle transmisión l/rueda 1.3-1.4-1.6 y  
D hasta '94, r.o. 191498203C



**1575**  
kit rep transmisión l/rueda 1.8-2.0 hasta '94  
r.o. 191498203



**1575-E** para montar con cono  
kit rep transm. l/rueda 1.8-2.0 hasta '94  
r.o. 191498203



**1297**  
kit rep. transmisión l/rueda desde '94  
homocinética de Ø86 mm 1H0407285A



**1921**  
kit rep. transmisión l/rueda desde '94  
homocinética de Ø77 mm



**1102**  
kit fuelle transm. l/rueda TDi de 115-130-  
y 150cv (Ø29-98 mm), r.o. 1J0498203A



SEAT IBIZA - CORDOBA 1993-2002



**1560**  
kit rep. transm izqd l/cambio 1.8-2.0-TD  
hasta '94 (Ø 24-100 mm), r.o. 321407283A



**1637**  
kit rep. transm. dcha. l/cambio 1.8-2.0-TD  
hasta '94 (Ø 24-100 mm), r.o. 191407283



**1632**  
kit rep. transmisión l/cambio 1.05-1.3-1.4  
y 1.6 hasta '94, (Ø 21-89 mm)



**1192**  
kit rep. transmisión l/cambio desde '94  
(Ø 27-100 mm), r.o.



**1106**  
kit rep. transmisión l/cambio desde '94  
(Ø 27-94 mm), r.o.



**1061**  
kit rep. transmisión l/cambio desde '97  
(Ø 27-89 mm), r.o.

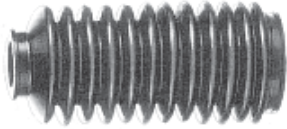

**1511**  
fuelle cremallera manual  
r.o. 191419831



**1765**  
fuelle cremallera asistida  
r.o. 175422831



**1765-C**  
kit reparación cremallera asistida  
r.o.



**2301**  
casquillo cremallera manual  
r.o. no hay despiece

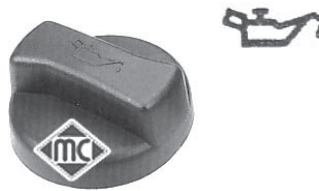

**3621**  
tapón llenado aceite motor  
r.o. 026103485



**3708**  
tapón de combustible (sin llave)  
r.o. 1H0201553B

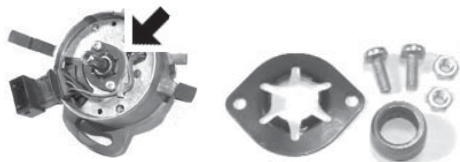

**4296**  
kit reparación distribuidor Magneti-Marelli  
(casquillo sinterizado del eje rotor)



**016**  
tapón cierre inyectores Diesel y TurboD  
r.o. 068130229A



**2695**  
soporte carburador 1.6-1.8 (monopunto)  
r.o. 050129761F/B



**2815**  
soporte carburador 1.3 (2G)  
r.o. 052129765E

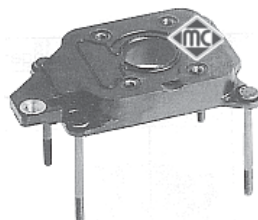

**2846**  
soporte carburador 1.05 (AAU)  
r.o. 030129765D

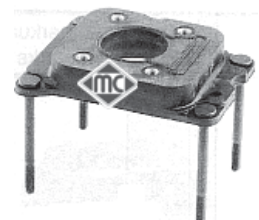

**2855**  
soporte carburador 1.6 (ABU)  
r.o. 032129765



**2699**  
soporte carburador 1.3(AAV) y 1.4(ABD)  
r.o. 030129765G



**3711**  
tubo entrada aire a caudalímetro 1.6-1.8  
r.o. 1J0129684N



**3718**  
tubo entrada aire a caudalímetro 1.9D/TDi  
r.o. 6K0129684F

## SEAT IBIZA - CORDOBA 1993-2002

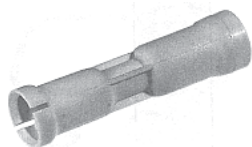

**2448**  
guía varilla nivel aceite 1.6-1.8-2.0  
r.o.053103663



**2876**  
guía varilla nivel aceite 1.9D-TD-SDi  
r.o.028103663B



**4355**  
guía varilla nivel aceite 1.4-1.6(75cv)  
r.o.030115636A



**3571**  
guía varilla nivel aceite TDi desde '98  
r.o.038103663



**3553**  
guía varilla nivel aceite 2.0 desde '98  
r.o.06A103663C



**3568**  
guía varilla nivel aceite 1.6-1.8 desde '98  
r.o.06A103663B

**¡Nuevo!**



**3688**  
guía varilla nivel aceite 1.05-1.3-1.6  
r.o.036115636

**¡Nuevo!**



**4793**  
varilla nivel aceite 1.4-1.6(75cv)  
r.o.

**¡Nuevo!**



**4942**  
varilla nivel aceite 1.9D-TD-TDi hasta '99  
r.o.028115611C

**¡Nuevo!**



**4759**  
varilla nivel aceite 1.9TDi desde '99-  
r.o.

**¡Nuevo!**



**4760**  
varilla nivel aceite 1.6(100cv)-1.8 y 2.0  
hasta '99, r.o.027115611C

**¡Nuevo!**



**4795**  
varilla nivel aceite 1.6-1.8-2.0 desde '99-  
r.o.



**4290**  
polea cigueñal 1.9D-TD-TDi-SDi hasta '99  
r.o.028105243T

**¡Nuevo!**



**4421**  
polea cigueñal 1.9 TDi-SDi desde '99-  
r.o.038105243-038105243K



**4405**  
polea cigueñal 1.6(100cv)-1.8  
r.o.06A105243E-06A105255F

**¡Nuevo!**



**4768** Ø 78 mm  
rodillo tensor correa alternador 1.6-1.8-2.0-  
1.9D/TD/TDi(hasta '99),r.o.028145278E

**¡Nuevo!**



**4767** Ø 65 mm  
rodillo tensor correa alternador 1.9TDi-SDi  
desde '99-,r.o.038145276

**¡Nuevo!**

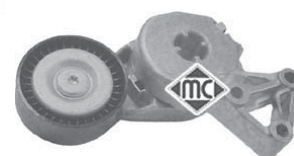

**5010**  
tensor correa alternador 1.6-1.8-2.0 desde  
'97-,r.o.06A903315E

**¡Nuevo!**

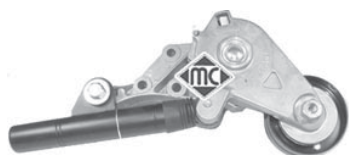

**4944**  
tensor correa alternador 1.9TDi desde '97-  
r.o.038903315C

**¡Nuevo!**

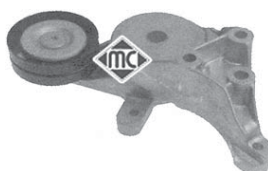

**5039**  
tensor correa alternador 1.9SDi  
r.o.038903315K

**¡Nuevo!**



**4770**  
tensor correa alternador 1.05-1.4-1.6  
sin aire acond., r.o.030145299F



SEAT IBIZA - CORDOBA 1993-2002

**iNuevo!**



**4908**  
tensor correa alternador 1.9TDi hasta '97  
r.o.028903315R

**iNuevo!**



**4909**  
tensor correa alternador 1.6/1.8/2.0 gasolina  
hasta '97, r.o.037903315C

**iNuevo!**



**4919** Ø 55/50 mm, H=40,5 mm  
polea alternador de rueda libre hasta '00  
r.o.028903119AA

**iNuevo!**



**4997** Ø 61/55 mm, H=41 mm  
polea alternador de rueda libre desde '00-  
r.o.022903119A

**iNuevo!**



**3681**  
cubierta correa distribución 1.6-1.8-2.0 hasta  
'99, r.o.026109173A

**iNuevo!**



**3715**  
cubierta superior correa distribución 1.6-1.8  
hasta '99, r.o.026109107B

**iNuevo!**



**3720**  
cubierta correa distribución 1.6(100cv)-2.0  
desde '99-, r.o.06A109108B/S

**iNuevo!**



**3672**  
válvula filtro gasoil hasta '99  
r.o.191127247A

**iNuevo!**



**3689**  
válvula filtro gasoil desde '99  
r.o.1J0197247-1J0197247A



**4364**  
soporte catalizador TDi desde '96  
r.o.1H0253144E



**2426**  
soporte presilenciador  
r.o.1H0253147B



**2423**  
soporte trasero escape  
r.o.1H0253674D



**4271**  
soporte trasero escape  
r.o.



**2780**  
junta de colector escape a culata  
r.o.028129589B



**2609**  
tuerca homocinética  
r.o.171407643A

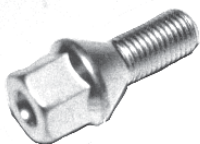

**792**  
tuerca rueda  
r.o.3A0601139



**674**  
tapón cárter de aceite hasta '98  
r.o.113115193



**2916**  
tapón cárter de aceite desde '98  
r.o.N90813201



**864**  
cubrepedal freno y embrague  
r.o.321721173



**2845**  
soporte de radiador  
r.o.6K0121267



**4365**  
jgo. tornillo sujeción tapa cubremotor  
r.o.028103665+028103937+028103638G



**SUSPENSION DELANTERA y SOPORTES DE MOTOR:**

1.2/3 cil.-1.4/3 cil.-1.4/16v-1.8/20v-2.0  
1.9SDi - 1.9TDi

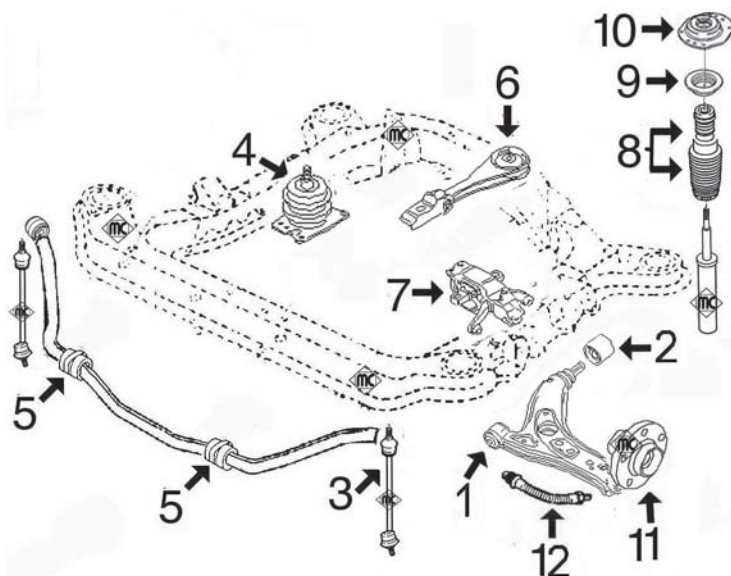

- 1- 4671 silentbloc anterior trapecio delantero
- 2- 4670 silentbloc posterior trapecio delantero
- 3- 4792 bieleta puntal barra estabilizadora completa
- 4- 4786 soporte motor derecho
- 5- 4918 goma barra estabilizadora
- 6- 4804 soporte motor trasero 1.4TDi-1.8/20v
- 4787 soporte motor trasero 1.2-1.4/3cil.-1.4/16v
- 4797 soporte motor trasero 1.9SDi-2.0
- 4804 soporte motor trasero 1.9TDi 5 velocidades
- 4805 soporte motor trasero 1.9TDi 6 velocidades
- 7- 4785 soporte motor izquierdo
- 8- 4765 juego fuelle amortiguador delantero completo con tope de poliuretano
- 9- 4789 rodamiento soporte amortiguador
- 10- 4788 soporte amortiguador delantero completo con rodamiento
- 11- 90100 buje rueda delantera con rodamiento
- 12- 96200 latiguillo freno delantero

**SUSPENSION TRASERA:**

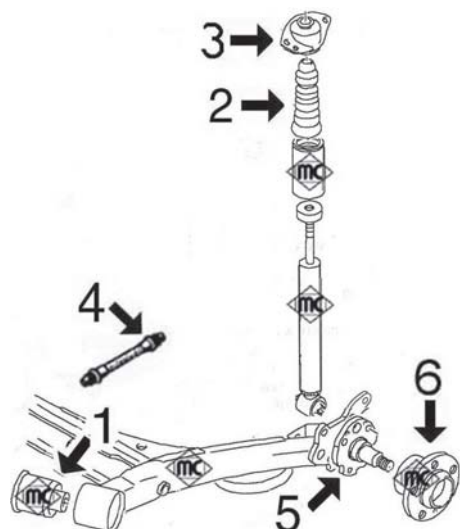

- 1- 4310 silentbloc brazo trasero suspensión
- 2- 4920 tope poliuretano amortiguador trasero
- 3- 4311 soporte amortiguador trasero
- 4- 96014 latiguillo freno trasero
- 5- n/d mangueta rueda trasera
- 6- 90503 buje rueda trasera con rodamiento

## SEAT IBIZA (2002 - )



**4310**  
silentbloc brazo suspensión trasera  
r.o. 1J0501541C



**4311**  
soporte amortiguador trasero  
r.o. 1J0513353B



**4670**  
silentbloc posterior trapecio delantero  
r.o. 6Q0407183A



**4671**  
silentbloc anterior trapecio delantero  
r.o. 6Q0407151D



**4765**  
juego fuelle amortiguador delantero y tope  
poliuretano, r.o. 6N0412303A-6N0413175A

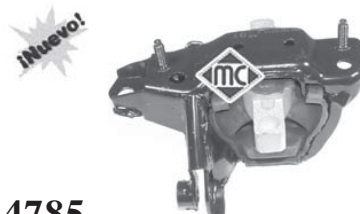

**4785**  
soporte motor izquierdo  
r.o. 6Q0199555AC/AD/AE/K



**4786**  
soporte motor derecho  
r.o. 6Q0199167CB/BM/CC/BC/CA/CD



**4787**  
soporte motor trasero 1.2-1.4-1.4/16v  
r.o. 6Q0199851AB/AE



**4788**  
soporte amortiguador delantero completo  
con rodamiento r.o. 6N0412331E

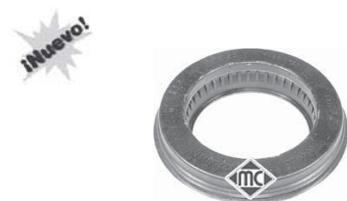

**4789**  
rodamiento soporte amortiguador delantero  
r.o. 6N0412249C



**4792**  
bioleta puntal barra estabilizadora  
r.o. 6Q0411315F



**4797**  
soporte motor trasero 1.9SDi-2.0  
r.o. 6Q0199851T/M/D



**4804**  
soporte motor trasero 1.9TDi 5 velocidades  
r.o. 6Q0199851AC/B/E/J



**4805**  
soporte motor trasero 1.9TDi 6 velocidades  
r.o. 6Q0199851N



**4918**  
goma barra estabilizadora delantera  
r.o.



**4920**  
tope poliuretano suspensión trasera  
r.o. 6Q0512131B



**90100**  
bujе rueda delantera con rodamiento  
r.o. 6Q0407621AJ



**90503**  
bujе rueda trasera con rodamiento  
r.o. 6Q0598611



**96200**  
latiguillo freno delantero (555 mm)  
r.o. 6Q0611701C



**96014**  
latiguillo freno trasero (165 mm)  
r.o. 6X0611775

SEAT IBIZA (2002 - )

**¡Nuevo!**



**3675**  
botella de expansión  
r.o.6Q0121407A

**¡Nuevo!**



**3677**  
tapón botella de expansión  
r.o.3B0121321



**3591**  
brida de agua en culata 1.9SDi  
r.o.038121132C



**3625**  
tubo de agua 1.4/16v  
r.o.6Q0121407A

**¡Nuevo!**

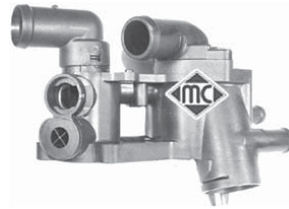

**3693**  
caja de termostato completa 1.4-1.4/16v  
r.o.032121111AP

**¡Nuevo!**

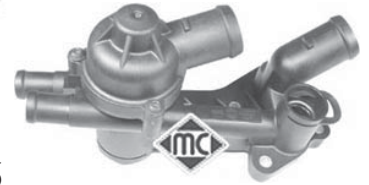

**3726**  
caja termostato completa 1.2 (3 cilindros)  
r.o.03C121111B

**¡Nuevo!**



**3727**  
tubo desvaporizador 1.9Diesel  
r.o.038103493H



**3621**  
tapón llenado aceite motor  
r.o.06B103485B/H

**¡Nuevo!**



**3688**  
guía varilla nivel aceite 1.2  
r.o.036115636



**4355**  
guía varilla nivel aceite 1.4/16v  
r.o.030115636A



**3568**  
guía varilla nivel aceite 1.8 gasolina  
r.o.06A103663B



**3571**  
guía varilla nivel aceite 1.9D  
r.o.038103663

**¡Nuevo!**



**3725**  
guía varilla nivel aceite 1.4TDi  
r.o.06A103663A



**3553**  
guía varilla nivel aceite 2.0 gasolina  
r.o.06A103663C

**¡Nuevo!**



**4793**  
varilla nivel aceite 1.4/16v  
r.o.

**¡Nuevo!**



**4794**  
varilla nivel aceite 1.4TDi  
r.o.

**¡Nuevo!**



**4759**  
varilla nivel aceite 1.9Diesel  
r.o.

**¡Nuevo!**



**4795**  
varilla nivel aceite 1.8 gasolina  
r.o.

**¡Nuevo!**



**4492**  
polea cigueñal 1.4 TDi  
r.o.045105243-045105243B

**¡Nuevo!**



**4494**  
polea cigueñal 1.9SDi  
r.o.038105243L-038105243M

**¡Nuevo!**



**4480**  
polea cigueñal 1.9TDi  
r.o.03G105243-038105243L

## SEAT IBIZA (2002 - )



**4405**  
polea cigüeñal 1.8-2.0 gasolina  
r.o. 06A105243E/F

**¡Nuevo!**



**4770**  
tensor correa alternador 1.4/16v  
r.o. 030145299F

**¡Nuevo!**

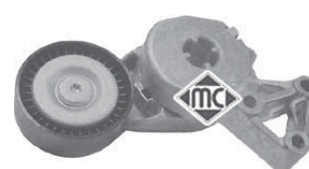

**5010**  
tensor correa alternador 1.6-1.8-2.0  
r.o. 06A903315E

**¡Nuevo!**



**4997**      **Ø 61/55 mm, H=41 mm**  
polea de alternador de rueda libre  
r.o. 022903119

**¡Nuevo!**



**5007**      **Ø 61/55 mm, H=36 mm**  
polea de alternador de rueda libre  
r.o. 03D903119A



**4365**  
juego tornillos fijación tapa motor  
r.o. 028103638G+028103665+028103937

**¡Nuevo!**



**4749**  
casquillo guía embrague  
r.o. 02A141180A



**4296**  
kit reparación distribuidor Magneti-Marelli  
(casquillo sinterizado del eje rotor)

**¡Nuevo!**



**3689**  
válvula filtro gasoil  
r.o. 1J0127247A



**864**  
cubrepedal freno y embrague  
r.o. 321721173



**792**  
tornillo rueda M-12x150x23,5  
r.o. 3A0601139



**2426**  
soporte anterior tubo de escape  
r.o. 6X0253147

**¡Nuevo!**



**4762**  
soporte posterior tubo de escape  
r.o. 6Q0253144G

**¡Nuevo!**



**4917**  
soporte posterior tubo de escape  
r.o. 6Q0253144B/D



**674**  
tapón cárter de aceite 1.2 - 1.9D - 1.8 - 2.0  
r.o. N90288901



**2916**  
tapón cárter de aceite 1.4/16v - 1.4TDi  
r.o. N90813201

**¡Nuevo!**



**3738**  
interruptor luz de freno (4 polos)  
r.o. 1J0945511D/C



CANALIZACIONES DE AGUA

INCA 1.4/8v 1.6/8v motores AEX-AKV-APQ de 60cv hasta '03 motor AEE de 75cv hasta '00

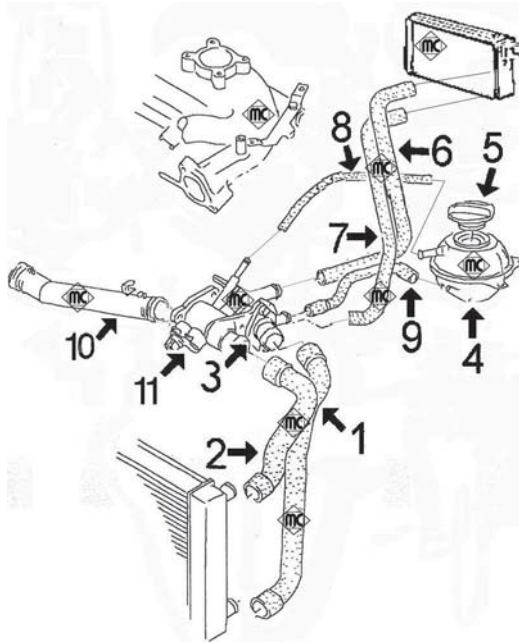

- 1- 8834 mgto inferior radiador
- 2- 8400 mgto superior radiador
- 3- 3592 kit de termostato completo con tapa y junta  
3541 tapa de termostato
- 4- 3504 botella de expansión
- 5- 3506 tapón botella de expansión
- 6- 8845 mgto entrada agua a calefactor sin toma para sensor  
8821 mgto entrada agua a calefactor con toma para sensor
- 7- 8846 mgto retorno agua de calefactor
- 8- 116 mgto sobrante de botella a mgto inferior y caja de termostato: cortar de rollo MC-116 Ø 8x14 mm, long. aprox. 350 mm
- 9- 8822 mgto de cuerpo termostato a botella
- 10- 3625 tubo de agua (plástico) con juntas tóricas
- 11- 3615 cuerpo de termostato completo con termostato, tapa y accesorios
  
- 8811 mgto desvaporizador

INCA 1.6 motor 1F de 75 cv hasta 5/'97

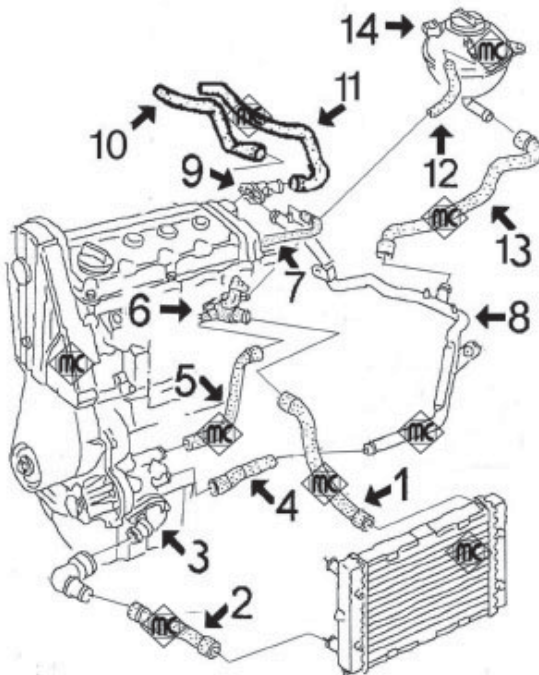

- 1- 8404 mgto superior radiador
- 2- 8403 mgto inferior radiador sin aire acondicionado  
8402 mgto inferior radiador con aire acondicionado
- 3- 3537 tapa de termostato  
3667 tapa de termostato completa con codo y junta
- 4- 8386 mgto de bomba de agua a tubo
- 5- 8383 mgto de bomba de agua a culata
- 6- 3522 brida en culata conexión mgtos
- 7- 8391 mgto de tubo metálico a colector
- 8- 3084 tubo de agua metálico
- 9- 3517 boquilla en culata
- 10- 8395 mgto de tubo metálico a calefactor
- 11- 8396 mgto de culata a calefactor
- 12- 116 mgto de sobrante de botella a radiador, cortar de rollo MC-116 Ø 8x15 mm longitud 750 mm
- 13- 8378 mgto de tubo metálico a botella
- 14- 3504 botella de expansión con sensor de nivel  
3506 tapón botella de expansión
  
- 8224 mgto desvaporizador
- 8226 mgto desvaporizador

## SEAT INCA (1996-2004)

**INCA 1.4/16v motor AUA de 75CV hasta '03**

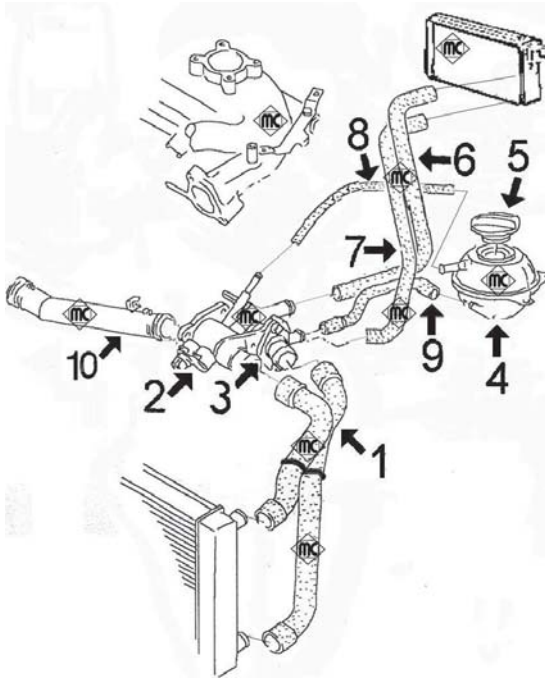

- 1- 9083 mgto superior e inferior radiador
- 2- 3615 cuerpo de termostato completo con termostato, tapa y accesorios
- 3- 3592 kit de termostato completo con tapa y junta  
3541 tapa de termostato
- 4- 3504 botella de expansión
- 5- 3506 tapón botella de expansión
- 6- 8845 mgto entrada agua a calefactor
- 7- 8846 mgto retorno agua de calefactor
- 8- 116 mgto sobrante de botella a mgto inferior y caja de termostato: cortar de rollo MC-116 Ø 8x14 mm, long. aprox. 350 mm
- 9- 8822 mgto de cuerpo termostato a botella
- 10- 3625 tubo de agua (plástico) con juntas tóricas

8811 mgto desvaporizador

**INCA 1.9 Diesel hasta '03**  
**1.9 SDi hasta '00**  
**1.7 SDi hasta '03**

**motor 1Y de 64cv hasta '03**  
**motor AEY de 64cv hasta '00**  
**motor AHB de 64cv hasta '03**

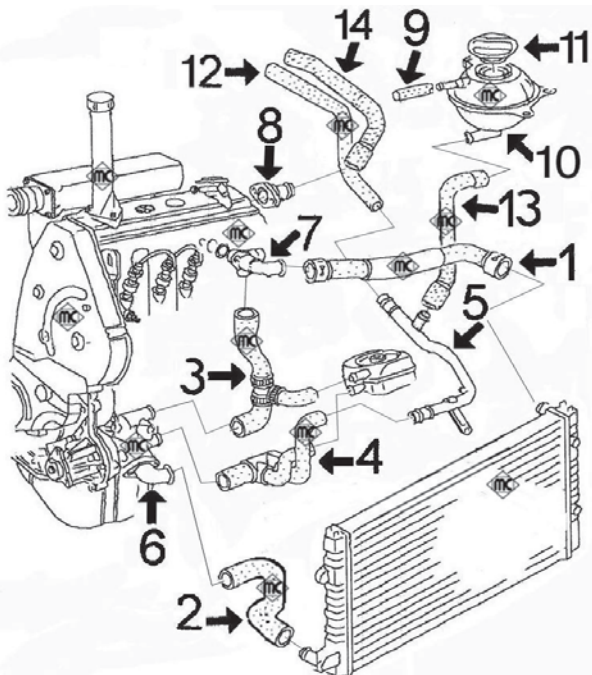

- 1- 8417 mgto superior radiador
- 2- 8406 mgto inferior radiador 1.9 Diesel  
8399 mgto inferior radiador 1.7SDi-1.9SDi
- 3- 8382 mgto de bomba agua a racor en culata
- 4- 8384 mgto de bomba agua a intercambiador y tubo metálico
- 5- 3084 tubo de agua metálico 1.9 Diesel  
3094 tubo de agua metálico 1.7SDi-1.9SDi
- 6- 3537 tapa de termostato  
3667 tapa de termostato completa con codo y junta
- 7- 3527 brida en culata 1.9 Diesel  
3542 racor en culata 1.7SDi-1.9SDi
- 8- 3517 boquilla lateral en culata
- 9- 116 mgto sobrante de botella: cortar de rollo MC-116 Ø 8x14 mm, long. aprox. 400 mm
- 10- 3504 botella de expansión
- 11- 3506 tapón botella de expansión
- 12- 8395 mgto de tubo metálico a calefactor
- 13- 8378 mgto de tubo metálico a botella expansión
- 14- 8396 mgto de culata a calefactor

## SEAT INCA (1996-2004)

INCA

1.9 TDi  
1.9 SDi

motor ALH de 90cv  
motor AYQ de 64cv

desde '00  
desde '00

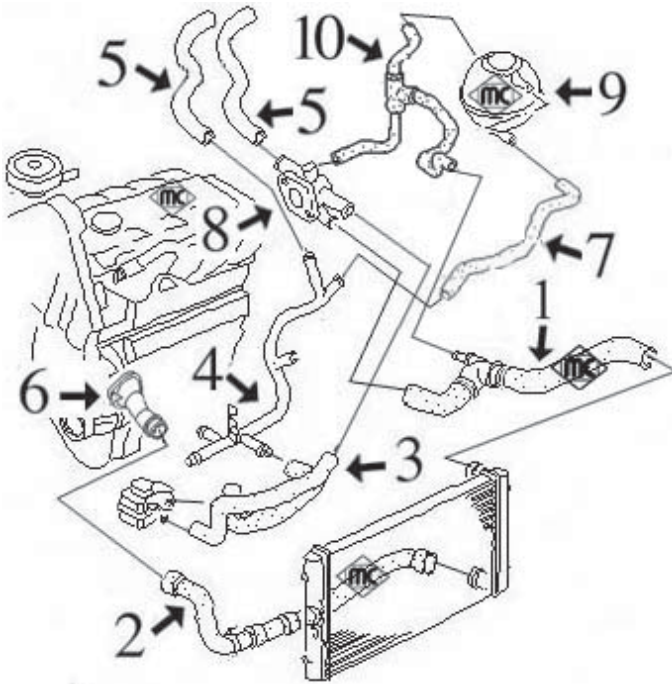

- 1- 9085 mgto superior radiador completo
- 2- 9084 mgto inferior radiador
- 3- 9080 mgto doble a intercambiador
- 4- 3186 tubo de agua metálico
- 5- 9088 juego mgto entrada/salida calefactor
- 6- 3590 boquilla entrada agua a bloque motor
- 7- 9090 mgto de tubo metálico a botella
- 8- 3591 caja de agua (plástico) en culata
- 9- 3504 botella de expansión  
3506 tapón botella de expansión
- 10- 9089 mgto de botella a caja de agua en culata

### TUBOS DESVAPORIZADORES 1.9D - TD - TDi - SDi (hasta 5/'99):

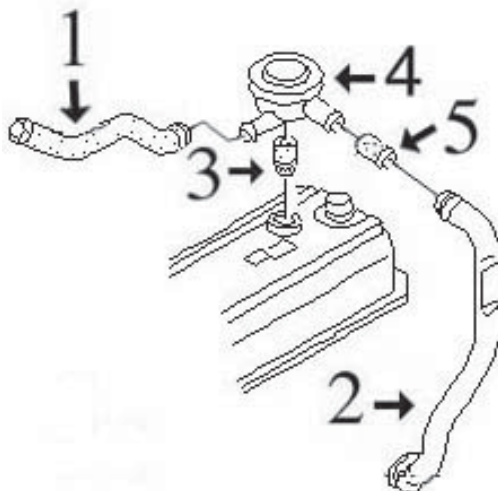

- 1- 8895 mgto de válvula desvaporizadora 1.9TDi  
8385 mgto de válvula desvaporizadora 1.9D
- 2- 3644 tubo plástico de válvula a cárter
- 3- 2669 junta válvula desvaporizadora
- 4- 3719 válvula desvaporizadora
- 5- 8385 mgto de válvula desvaporizadora 1.9D-TD (no TDi!)



## SEAT INCA (1996-2004)



**8224**  
mgto desvaporizador 1.6(1F)  
r.o.051103493A-048103493A



**8226**  
mgto desvaporizador 1.6(1F)  
r.o.050103493A



**8377**  
mgto depresor servofreno todos mods.  
r.o.321611939E



**8378**  
mgto de tubo metálico a botella 1.6 (1F)  
r.o.1H0121109-1H0121109A



**8382**  
mgto de bomba a brida en culata D-SDi  
r.o.028121053Q/S/L/P



**8383**  
mgto de bomba a brida en culata 1.6 (1F)  
r.o.037121053H



**8384**  
mgto de bomba a intercambiador y tubo Diesel y SDi, r.o.037122058B



**8385**  
mgto desvaporizador Diesel y SDi  
r.o.028103493E



**8386**  
mgto de bomba a tubo metálico 1.6 (1F)  
r.o.037121063A



**8391**  
mgto de tubo metálico a colector 1.6 (1F)  
r.o.051121056



**8395**  
mgto calefactor 1.6(1F)-Diesel y SDi  
r.o.1H0819373C



**8396**  
mgto calefactor 1.6(1F)-Diesel y SDi  
r.o.1H0819371



**8399**  
mgto inferior radiador 1.7SDi-1.9SDi  
r.o.6K0121051K/H



**8400**  
mgto superior radiador 1.4-1.6(AEE)  
r.o.6K0121101



**8402**  
mgto inferior radiador 1.6(1F) con aire ac.  
r.o.6K0121051C



**8403**  
mgto inferior radiador 1.6(1F) sin aire acond.  
r.o.6K0121051A



**8404**  
mgto superior radiador 1.6(1F)  
r.o.6K0121101A



**8406**  
mgto inferior radiador 1.9Diesel (1Y)  
r.o.1H0121051B



**8417**  
mgto superior radiador Diesel y SDi  
r.o.6K0121101G

















**8812**  
mgto desvaporizador 1.6  
r.o.1H0103493





















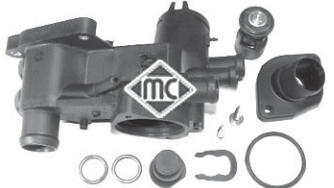

**8821**  
mgto entrada a calefactor 1.4-1.6 con toma para sensor, r.o.



SEAT INCA (1996-2004)

 <p><b>8822</b> mgto de caja termostato a botella 1.4-1.6 r.o.</p>	 <p><b>8834</b> mgto inferior radiador 1.4-1.6 r.o.</p>	
 <p><b>8845</b> mgto entrada a calefactor 1.4-1.6 r.o.</p>	 <p><b>8846</b> mgto retorno calefactor 1.4-1.6 r.o.</p>	<p><b>¡Nuevo!</b></p>  <p><b>8895</b> mgto desvaporizador 1.9TDi r.o.028103493S</p>
<p><b>¡Nuevo!</b></p>  <p><b>9080</b> mgto de intercambiador a tubo 1.9SDi-TDi r.o.</p>	<p><b>¡Nuevo!</b></p>  <p><b>9083</b> mgto superior/inferior 1.4-16v '00- r.o.</p>	<p><b>¡Nuevo!</b></p>  <p><b>9084</b> mgto inferior radiador 1.9SDi-1.9TDi '00- r.o.</p>
<p><b>¡Nuevo!</b></p>  <p><b>9085</b> mgto sup radiador 1.9SDi-TDi '00- r.o.</p>	<p><b>¡Nuevo!</b></p>  <p><b>9088</b> jgo mgto calefactor 1.9 SDi-TDi '00- r.o.</p>	<p><b>¡Nuevo!</b></p>  <p><b>9089</b> mgto de culata a botella 1.9SDi-TDi r.o.</p>
<p><b>¡Nuevo!</b></p>  <p><b>9090</b> mgto de tubo metálico a botella 1.9TDi-SDi r.o.</p>	<p><b>¡Nuevo!</b></p>  <p><b>3722</b> tubo desvaporizador 1.9TDi desde 5/'99 r.o.038103493P</p>	

## SEAT INCA (1996-2004)

 <p><b>3517</b> boquilla en culata 1.6(1F)-Diesel y SDi r.o.037121145</p>	 <p><b>3522</b> brida en culata 1.6(1F) r.o.037121133F-037121132E-037121132G</p>	 <p><b>3527</b> brida en culata Diesel (1Y) r.o.068121133AB/AE</p>
 <p><b>3537</b> tapa de termostato 1.6(1F)-Diesel-SDi r.o.037121121A+1H0121687</p>	 <p><b>3540</b> kit tapón cierre alojamiento sensores r.o.357121140+032121142+N90316802</p>	 <p><b>3541</b> tapa de termostato 1.4-1.6(AEE) r.o.032121121B-J</p>
 <p><b>3542</b> brida en culata 1.7SDi-1.9SDi r.o.028121132A</p>	 <p><b>3592</b> kit completo de termostato, tapa y junta 1.0- <b>con termostato</b>, tapa y accesorios</p>	 <p><b>3615</b> cuerpo de termostato 1.0-1.4-1.6 completo <b>con termostato</b>, r.o.032121111N</p>
 <p><b>3590</b> tapa de termostato 1.9TDi-SDi <b>desde '00</b> r.o.038121121</p>	 <p><b>3591</b> tapa en culata (lateral) 1.9TDi-SDi <b>desde '00</b> r.o.038121132C</p>	 <p><b>2669</b> junta válvula desvaporizadora r.o.028103500</p>
 <p><b>3084</b> tubo de agua metálico 1.6(1F)-1.9Diesel(1Y) r.o.037121065K/L/G/H</p>	 <p><b>3094</b> tubo de agua metálico 1.7SDi-1.9SDi r.o.028121065K/T</p>	 <p><b>3186</b> tubo de agua metálico 1.9TDi-SDi desde '00 r.o.</p>
 <p><b>3625</b> tubo de agua (plástico) con juntas tóricas 1.4-1.6(AEE), r.o.</p>	 <p><b>3644</b> tubo desvaporizador 1.9TDi-SDi r.o.028103491J</p>	 <p><b>3667</b> boquilla salida termostato completo r.o.</p>
 <p><b>3719</b> válvula desvaporizadora 1.9TDi-SDi r.o.028129101D</p>	 <p><b>3504</b> botella de expansión r.o.1H0121407A</p>	 <p><b>3506</b> tapón botella de expansión r.o.1H0121321A</p>



CANALIZACIONES de AIRE de ALTA PRESION INTERCOOLER-TURBO:

INCA

1.9 Diesel motores TDi desde 11/'95 a 9/'00  
(AHU-1Z-AFN-ALE)

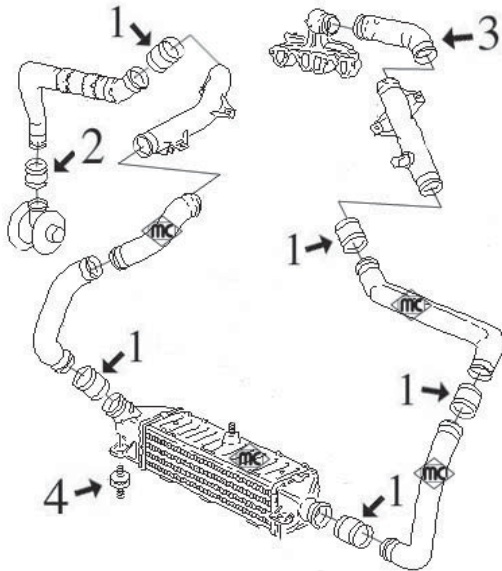

- 1- 9061 tubo flexible de empalme
- 2- 9062 tubo flexible de empalme
- 3- 9060 tubo flexible de colector de aspiración a tubo
- 4- n/d soporte elástico intercooler

INCA

1.9 Diesel motor TDi desde 9/'00  
(ALH)

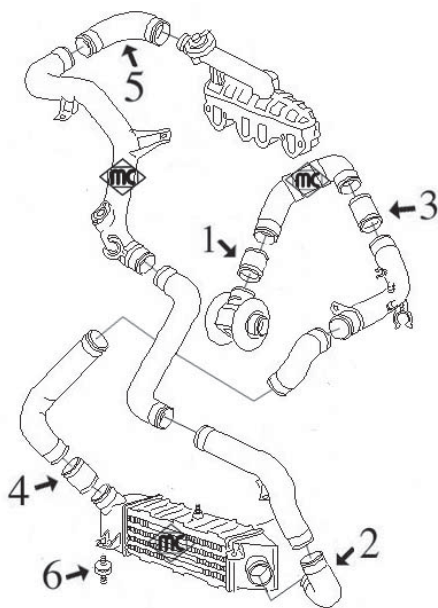

- 1- 9062 tubo flexible de empalme
- 2- 9063 tubo flexible a intercooler
- 3- 9061 tubo flexible de empalme
- 4- 9064 tubo flexible de empalme
- 5- 9065 tubo flexible de colector de aspiración a tubo rígido
- 6- n/d soporte elástico intercooler

SEAT INCA (1996-2004)

<p><b>¡Nuevo!</b></p>  <p><b>9060</b> tubo flexible de colector a tubo r.o. 1H0145838G</p>	<p><b>¡Nuevo!</b></p>  <p><b>9061</b>      <math>\text{Ø } 50 \times 60</math> largo 58 mm tubo flexible de alta presion de empalme r.o. 1H0145834E</p>	<p><b>¡Nuevo!</b></p>  <p><b>9062</b>      <math>\text{Ø } 35 \times 45</math> largo 58 mm tubo flexible de alta presion de empalme r.o. 3A0145972A</p>
<p><b>¡Nuevo!</b></p>  <p><b>9063</b> tubo flexible a intercooler r.o. 6K0145832C</p>	<p><b>¡Nuevo!</b></p>  <p><b>9064</b>      <math>\text{Ø } 60 \times 70</math> largo 58 mm tubo flexible de alta presion de empalme r.o. 1J0145834A</p>	<p><b>¡Nuevo!</b></p>  <p><b>9065</b> tubo flexible de colector a tubo rígido r.o. 6K0145838B</p>

CANALIZACIONES de COMBUSTIBLE:

INCA      1.6-75 CV motor 1F (hasta 5/'97)

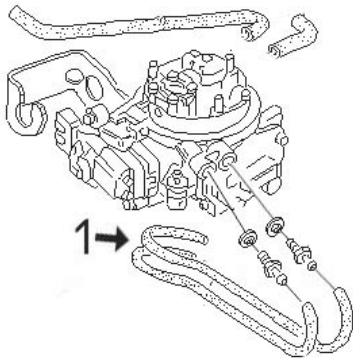

1- 9062 juego de tubos entrada/salida gasolina a unidad de inyección

<p><b>¡Nuevo!</b></p>  <p><b>9146</b> jgo tubos entrada/salida gasolina a unidad de inyección, r.o. 6K0133699B+6K0133723B</p>		
--	--	--



SUSPENSION DELANTERA y SOPORTES DE MOTOR:

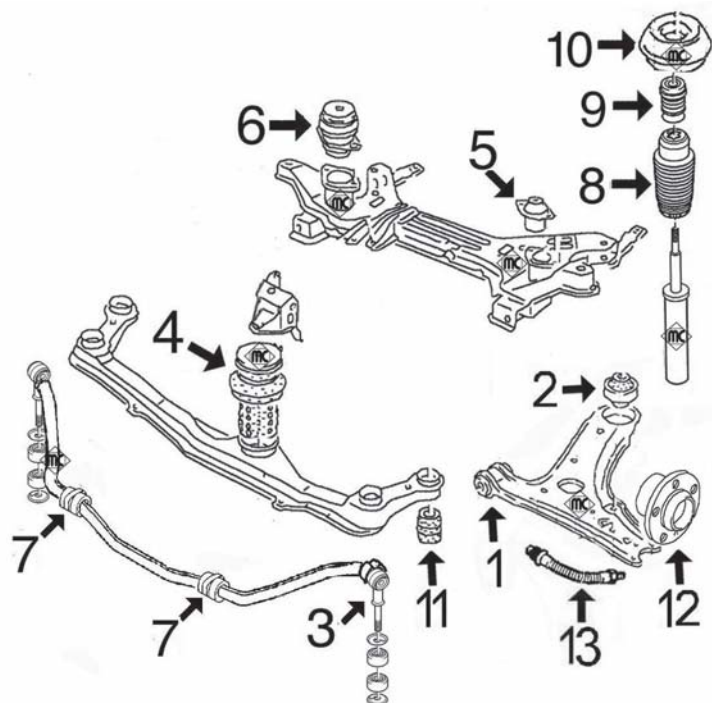

- 1- 542 silentbloc anterior trapecio delantero
- 2- 2660 silentbloc posterior trapecio delantero Golf-3
- 3- 2852 bieleta puntal barra estabilizadora
- 4- 2685 soporte motor delantero
- 5- 2627 soporte motor trasero izquierdo 1.4 y 1.6(AEE)  
4362 soporte motor trasero izquierdo 1.6(1F)-D y SDi
- 6- 2686 soporte motor trasero derecho
- 7- 917 goma para barra estabilizadora de Ø 18 mm  
4266 goma para barra estabilizadora de Ø 20 mm
- 8- 4324 capuchón amortiguador delantero
- 9- 4298 tope de amortiguador (poliuretano)
- 10- 2812 soporte amortiguador completo con rodamiento  
4128 rodamiento soporte amortiguador
- 11- 2444 silentbloc soporte travesia delantera
- 12- 90073 buje rueda delantera, freno sin ABS  
90035 buje rueda delantera, freno con ABS
- 13- 96124 latiguillo freno delantero (485 mm)



**542**  
silentbloc anterior trapecio delantero  
r.o. 191407182E



**917**  
goma para barra estabilizadora de Ø 18 mm  
r.o. 191411314



**2444**  
silentbloc sub-chasis delantero  
r.o. 1H0199233A



**2627**  
soporte motor trasero izquierdo 1.4-1.6(AEE)  
r.o. 191199381A



**2660**  
silentbloc posterior trapecio delantero  
(aluminio), r.o. 191407181E



**2685**  
soporte motor delantero  
r.o. 1H0199609E/F



**2686**  
soporte motor trasero derecho  
r.o. 1H0199262A/E/F



**2812**  
soporte amortiguador delantero completo  
con rodamiento, r.o. 357412331A

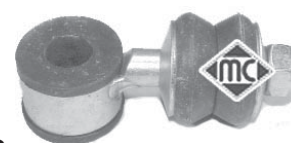

**2852**  
bieleta puntal barra estabilizadora  
r.o. 191411315A

## SEAT INCA (1996-2004)



**4128**  
rodamiento soporte amortiguador delantero  
r.o. 1J0412249

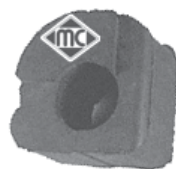

**4266**  
goma para barra estabilizadora de Ø 20 mm  
r.o. 1H0411314



**4298**  
tope poliuretano amortiguador delantero  
r.o. 1H0412303B



**4324**  
capuchón amortiguador delantero  
r.o. 357413175A



**4362**  
soporte motor trasero izquierdo D-SDi y 1.6  
(motor 1F), r.o. 3A0199402



**90073**  
bujes rueda delantera, freno sin ABS  
r.o. 357407615



**90035**  
bujes rueda delantera, freno con ABS  
r.o. 357407613B

















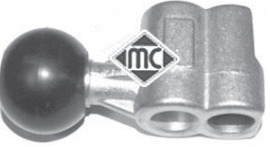
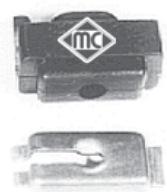

**96124**  
latiguillo freno delantero (485 mm)  
r.o. 1H0611701

**Nuevo!**

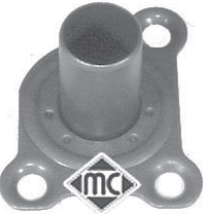

**96202**  
latiguillo freno trasero (430 mm)  
r.o. 6K0611776

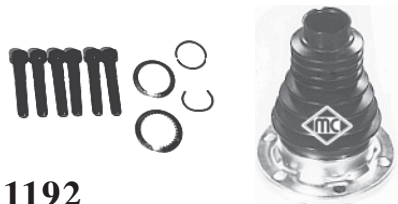
**SEAT INCA (1996-2004)**

<p><i>Nuevo!</i></p>  <p><b>3724</b> juego reparación rótula palanca de cambio r.o. 191711251A</p>	 <p><b>2841</b> juego reparación palanca de cambio r.o. 1H0711173+191711590A</p>	 <p><b>4361</b> guía soporte barra cambio r.o. 1H0711083</p>
 <p><b>2879</b>                      largo 60 mm bieleta selector de velocidades r.o. 1H0711595</p>	 <p><b>2878</b> varilla selector de velocidades r.o. 1H0711574</p>	<p><i>Nuevo!</i></p>  <p><b>4766</b> guía cerradura maneta puerta r.o. 1H0837223B</p>
 <p><b>4141</b> péndulo selector velocidades TDi hasta 9/97 r.o. 1L0711051</p>	 <p><b>4360</b> péndulo selector velocidades TDi desde 9/97, r.o. 1H0711051B</p>	<p><i>Nuevo!</i></p>  <p><b>3691</b> articulación cambio 1.9TDi r.o. 1J0711256</p>
<p><i>Nuevo!</i></p>  <p><b>4902</b> articulación cambio 1.4-1.6 hasta '99, r.o. 191711233</p>	 <p><b>2854</b> tope cable embrague r.o. 1H0798303A</p>	<p><i>Nuevo!</i></p>  <p><b>4749</b> guía embrague con retén 1.9TDi r.o. 02A141180A</p>
<p><i>Nuevo!</i></p>  <p><b>4903</b> guía embrague 1.4-1.6 r.o. 085141181</p>	<p><i>Nuevo!</i></p>  <p><b>4772</b> juego palanca de desembrague 1.6-1.9TDi-SDi-1.7SDi, r.o. 02K141709A+020141723C</p>	<p><i>Nuevo!</i></p>  <p><b>4906</b> varilla accionamiento embrague (341 mm) r.o. 020141741B</p>
 <p><b>1921</b> kit fuelle transmisión lado rueda homocinética de Ø 78 mm, r.o. 191498203C</p>	 <p><b>1297</b> kit fuelle transmisión lado rueda homocinética de Ø 86 mm, r.o. 1H0498203</p>	
 <p><b>1632</b> kit rep. transmisión l/cambio (Ø 21-89 mm), r.o. 171498201A</p>	 <p><b>1192</b> kit rep. transmisión lado cambio SDi, (Ø 27-100 mm), r.o. 191498202A</p>	<p><i>Nuevo!</i></p>  <p><b>1061</b> kit rep. transmisión l/cambio (Ø 27-89 mm), r.o.</p>

## SEAT INCA (1996-2004)

 <p><b>1765</b> fuelle cremallera asistida r.o. 175422831</p>	 <p><b>1765-C</b> kit reparación cremallera asistida r.o.</p>	
 <p><b>2448</b> guía varilla nivel aceite 1.6 (motor 1F) r.o. 053103663</p>	 <p><b>2876</b> guía varilla nivel aceite 1.9D-SDi hasta '99 r.o. 028103663B</p>	 <p><b>4355</b> guía varilla nivel aceite 1.4-1.6 (motor AEE) r.o. 030115636A</p>
 <p><b>3571</b> guía varilla nivel aceite SDi desde '99 r.o. 038103663</p>	 <p><b>4793</b> varilla nivel aceite 1.4-16 r.o.</p>	 <p><b>4759</b> varilla nivel aceite 1.9TDi-SDi desde '00 r.o.</p>
 <p><b>4760</b> varilla nivel aceite 1.6-75CV (1F, hasta '97) r.o. 027115611C</p>	 <p><b>4942</b> varilla nivel aceite 1.9TDi-SDi hasta '00 r.o. 028115611C</p>	 <p><b>3621</b> tapón llenado aceite motor r.o. 026103485</p>
 <p><b>3681</b> cubierta correa distribución 1.6-75CV (1F) r.o. 026109173A</p>	 <p><b>3715</b> cubierta correa distribución 1.6-75CV (1F) r.o. 026109107B</p>	 <p><b>3718</b> tubo entrada aire a caudalímetro 1.9TDi r.o. 6K0129684F</p>
 <p><b>4290</b> polea cigueñal 1.9TDi-1.7SDi hasta '03 y 1.9SDi hasta '01, r.o. 028105243T</p>	 <p><b>4421</b> polea cigueñal 1.9SDi desde '01 hasta '03 r.o. 038105243</p>	 <p><b>4480</b> polea cigueñal 1.9SDi desde '03 r.o. 03G105243</p>
 <p><b>4296</b> kit reparación distribuidor Magneti-Marelli 1.4-1.6 (casquillo sinterizado del eje rotor)</p>	 <p><b>3672</b> válvula filtro gasoil r.o. 191127247A</p>	 <p><b>2695</b> soporte carburador 1.6 motor 1F r.o. 050129761H</p>



SEAT INCA (1996-2004)

<p><b>4768</b> rodillo tensor correa alternador 1.6-75CV, 1.9SDi-TDi hasta '00 y 1.7SDi r.o. 028145278E</p>  <p>Ø 78 mm</p>	<p><b>4767</b> rodillo tensor correa alternador 1.9TDi desde '00, r.o. 038145276</p>  <p>Ø 65 mm</p>	<p><b>4770</b> tensor correa alternador 1.4-1.6 r.o. 030145299F</p> 
<p><b>4771</b> rodillo tensor correa alternador 1.9D (AEF) desde '97, r.o. 028145278M</p> 	<p><b>4908</b> tensor correa alternador 1.9TDi r.o. 028903315R</p> 	<p><b>4909</b> tensor correa alternador 1.6 gasolina (1F) r.o. 037903315C</p> 
<p><b>4919</b> polea de alternador de rueda libre r.o. 028903119AA</p>  <p>Ø 55/50 mm, H=40,5 mm</p>	<p><b>4997</b> polea de alternador de rueda libre r.o. 022903119A</p>  <p>Ø 61/55 mm, H=41 mm</p>	
<p><b>4364</b> soporte catalizador r.o. 1H0253144E</p> 	<p><b>2426</b> soporte presilenciador r.o. 1H0253147B</p> 	<p><b>2425</b> soporte trasero escape r.o. 1H0253144C</p> 
<p><b>2780</b> junta de colector escape a culata D-SDi r.o. 028129589B</p> 	<p><b>2845</b> soporte superior radiador r.o. 6K0121267</p> 	<p><b>4365</b> jgo. tornillo sujeción tapa cubremotor r.o. 028103665+028103937+028103638G</p> 
<p><b>792</b> tuerca rueda r.o. 3A0601139</p> 	<p><b>674</b> tapón cárter de aceite hasta '98 r.o. 113115193</p> 	<p><b>2916</b> tapón cárter de aceite desde '98 r.o. N90813201</p> 
<p><b>864</b> cubrepedal freno y embrague r.o. 321721173</p> 		

## SEAT PANDA - MARBELLA - TRANS - TERRA

### CANALIZACIONES DE AGUA. PANDA y TRANS hasta '86

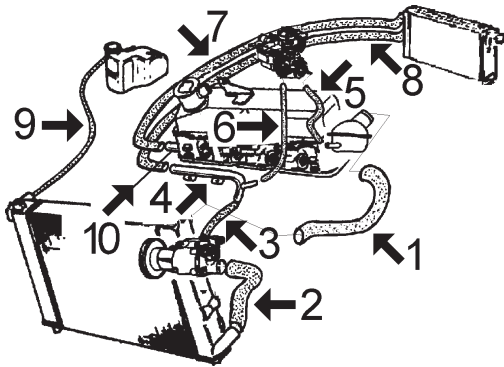

- 1- 7289 mgto superior radiador Panda
  - 2- 7288 mgto inferior radiador
  - 3- 5633 mgto de bomba a tubo metálico
  - 4- 3007 tubo de agua metálico
  - 5- 7290 mgto de termostato a carburador
  - 6- 7382 mgto de tubo metálico a carburador
  - 7- 7539 mgto de calefactor a termostato
  - 8- 7540 mgto de calefactor a tubo metálico
  - 9- 116 mgto de botella a radiador: Cortar de rollo MC-116 Ø 8x14 mm, longitud aprox. 75 cms
  - 10- n/d boquilla metálica roscada en culata
- 7291 mgto desvaporizador de tapa a filtro de aire

### MARBELLA y TERRA, hasta '90

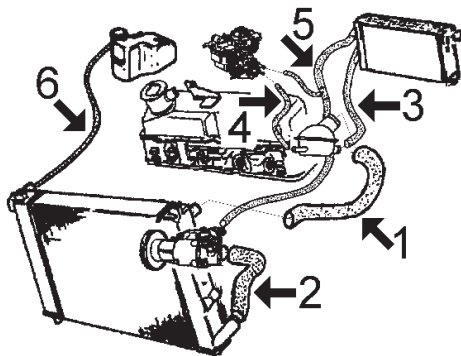

- 1- 7289 mgto superior rad. Marbella 4 veloc. y Terra
  - 7325 mgto superior radiador Marbella 5 velocidades
  - 2- 7288 mgto inferior rad. Marbella y Terra
  - 3- 7706 mgto de calefactor a termostato
  - 4- 7290 mgto de termostato a carburador
  - 5- 7707 mgto de calefactor a bomba y carburador (3 vias)
  - 6- 116 mgto de botella a radiador: Cortar de rollo MC-116 Ø 8x14 mm, long. aprox 75 cms.
- 7291 mgto desvaporizador de tapa a filtro de aire

### MARBELLA y TERRA (gasolina), desde '90:

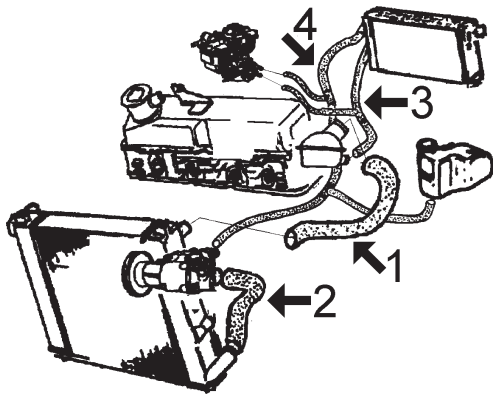

- 1- 8018 mgto superior radiador
  - 2- 8017 mgto inferior radiador
  - 3- n/d mgto de calefactor a termostato (3 vias)
  - 4- n/d mgto de calefactor a bomba, carburador y botella (4 vias)
- 7291 mgto desvaporizador de tapa a filtro de aire

### TERRA DIESEL, desde '90

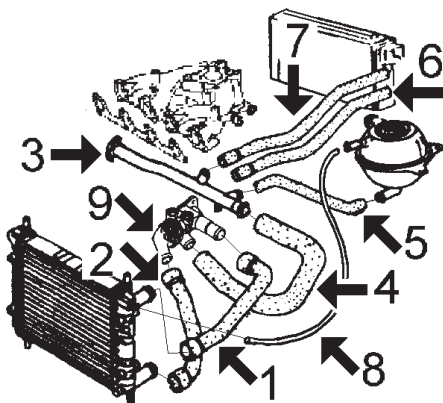

- 1- 7633 mgto superior radiador
  - 2- 7632 mgto inferior radiador
  - 3- 3087 tubo de agua metálico
  - 4- 7929 mgto de racor entrada agua a tubo metálico
  - 5- 7914 mgto de tubo metálico a botella
  - 6- n/d mgto de calefactor a culata
  - 7- n/d mgto de calefactor a tubo metálico
  - 8- 116 mgto de botella a radiador: Cortar de rollo MC-116 Ø 8x14 mm longitud aprox. 65 cms.
  - 9- 3528 tapa de termostato (plástico)
- 8085 mgto desvaporizador de bloque a tapa de balancines, 3 vias

## SEAT PANDA - MARBELLA - TRANS - TERRA

 <p><b>5633</b> mgto de bomba a tubo Panda r.o.XO-3935803</p>	 <p><b>7288</b> mgto inferior radiador Panda-Marbella r.o.XO-4405595</p>	 <p><b>7289</b> mgto superior radiador Panda desde '82- Trans-Terra-Marb.-r.o.SE-141117205A</p>
 <p><b>7290</b> mgto de termostato a carburador r.o.SE-020032161A</p>	 <p><b>7291</b> mgto desvaporizador a filtro de aire r.o.SE-020004465A</p>	 <p><b>7325</b> mgto superior radiador Marbella 5 v. r.o.SE-141117205B</p>
 <p><b>7330</b> mgto llenado combustible (Ø48x55, largo 110)r.o. SE-141104311A</p>	 <p><b>7539</b> mgto calefactor Panda 35-45 r.o.SE-141186332A</p>	
 <p><b>7540</b> mgto calefactor Panda 35-45 r.o.SE-141186333A</p>	 <p><b>7706</b> mgto calefactor Marbella-Terra r.o.SE-141186332</p>	 <p><b>7707</b> mgto calefactor Marbella-Terra hasta '90 r.o.</p>
 <p><b>7914</b> mgto de tubo a botella Terra Diesel r.o.SE-029117299B</p>	 <p><b>7929</b> mgto de racor entrada a tubo Terra Diesel r.o.SE-030121063A</p>	 <p><b>8017</b> mgto inferior radiador Marbella desde '90 r.o.SE-029117205C</p>
 <p><b>8018</b> mgto superior radiador Marbella desde '90 r.o.SE-029117223B</p>	 <p><b>7633</b> mgto superior radiador Terra Diesel r.o.SE-029117205A</p>	 <p><b>7632</b> mgto inferior radiador Terra Diesel r.o.SE-029117207A</p>
 <p><b>8085</b> mgto desvaporizador Terra Diesel r.o.SE-030103493M</p>		

## SEAT PANDA - MARBELLA - TRANS - TERRA



**3007**  
tubo de agua metálico Panda-Trans  
r.o. SE-020032139A



**3087**  
tubo de agua metálico Terra Diesel  
r.o. 030121065A



**3528**  
tapa de termostato Terra Diesel  
r.o. 030121211B

### SUSPENSION DELANTERA y SOPORTES DE MOTOR:

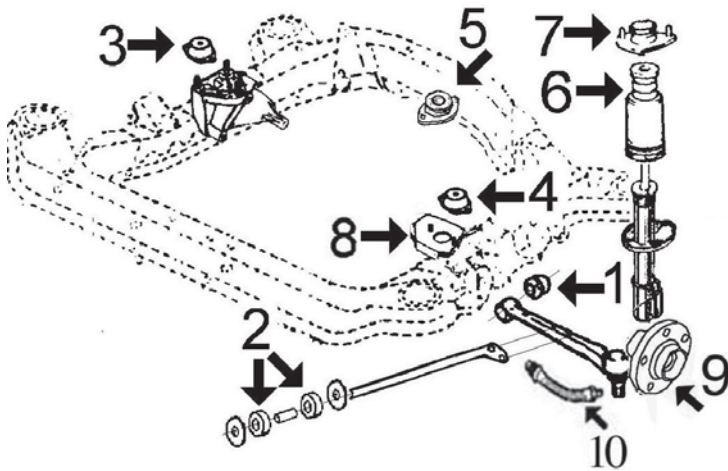

- 1- 269 silentbloc extremo brazo delantero hasta '82
- 459 silentbloc extremo brazo delantero desde '82
- 2- 464 goma tirante brazo delantero
- 3- 259 soporte de motor derecho (salvo Terra Diesel)
- 2630 soporte de motor izquierdo Terra Diesel
- 4- 251 soporte de motor izquierdo (salvo Terra Diesel)
- 802 soporte de motor izquierdo Terra Diesel
- 5- 259 soporte de motor trasero Panda 35
- 582 soporte de motor trasero Panda 40-45-Marbella Trans y Terra (salvo Diesel)
- 802 soporte de motor trasero Terra Diesel
- 6- 682 capuchón amortiguador delantero hasta '90
- 2329 capuchón amortiguador delantero desde '90
- 7- n/d soporte amortiguador delantero hasta '90
- 923 soporte amortiguador delantero desde '90 (con rodamiento de Ø 14 mm)
- 8- 2654 chapa soporte cambio de 4 velocidades (salvo D)
- 4070 chapa soporte cambio de 5 velocidades (salvo D)
- 9- 90009 buje de rueda delantera
- 10- 96144 latiguillo freno delantero PANDA
- 96169 latiguillo freno delantero TERRA

### SUSPENSION TRASERA,

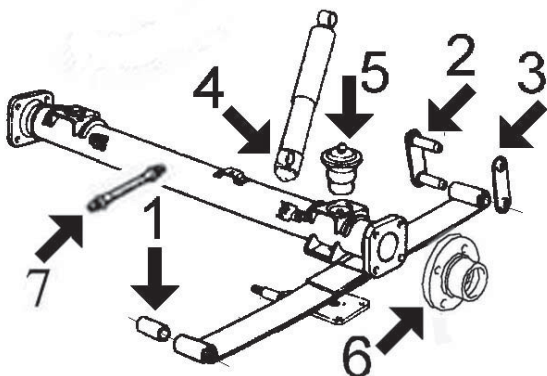

- 1- n/d silentbloc anterior ballesta
- 2- 720 juego gomas soporte trasero de ballesta
- 3- 719 soporte trasero de ballesta completo
- 4- 022 gomas sujeción amortiguadores
- 5- n/d tope de suspensión
- 6- n/d buje rueda trasera con rodamiento
- 7- 96095 latiguillo freno trasero



## SEAT PANDA - MARBELLA - TRANS - TERRA

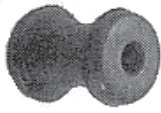

**269**  
silentbloc extremo brazo delantero hasta '82  
r.o. SE-127156137A



**459**  
silentbloc extremo brazo delantero d/ '82  
r.o. SE-141156137A

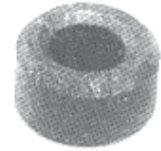

**464**  
goma tirante brazo delantero  
r.o. SE-138156244A



**259** (altura casquillo central 48 mm)  
soporte de motor derecho (salvo Terra D)  
r.o.



**251** (altura casquillo central 54 mm)  
soporte de motor izquierdo (salvo Terra D)  
r.o. SE-14154605A



**582**  
soporte de motor trasero Panda 40-45-  
Trans-Marbella y Terra, SE-141154805A



**802**  
soporte motor izquierdo y tras. Terra Diesel  
r.o. SE-867199383A



**2630**  
soporte motor derecho Terra Diesel  
r.o. 867199323A



**2654**  
soporte cambio Panda-Marbella gasolina  
r.o. SE-141128070A



**4070**  
soporte cambio Marbella 5 velocidades  
r.o. SE-141128070B



**682**  
capuchón amortiguador delantero hasta '90  
r.o. SE-141156212A



**2329**  
capuchón amortiguador delantero d/ '90  
r.o. SE-028156001A



**923** rodamiento de Ø 14 mm  
soporte amortiguador delantero desde '90  
con rodamiento, r.o. SE-021156228A



**022**  
goma sujeción amortiguadores traseros  
r.o. SE-141156206A



**720**  
juego gomas soporte posterior ballesta  
r.o. SE-024157013B y SE-024157013A



**719**  
soporte posterior ballesta completo  
r.o.

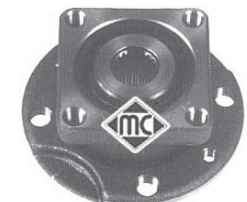

**90009**  
buje de rueda delantera con rodamiento  
r.o. XO-3981586



**96144**  
latiguillo freno delantero PANDA (455 mm)  
r.o.



**96169**  
latiguillo freno delantero TERRA (485 mm)  
r.o.



**96095**  
latiguillo freno trasero PANDA-MARBELLA-TERRA (290 mm), r.o.

## SEAT PANDA - MARBELLA - TRANS - TERRA



**1170**  
kit fuelle transm. l/rda Panda y Trans  
r.o. SE-127141537



**1514**  
kit rep. transmisión l/rueda Marbella-Terra  
r.o. SE-127141537A



**1577**  
kit rep. transmisión l/rueda Terra Diesel  
r.o.



**1636**  
kit rep. transm. l/cambio Marbella-Terra  
completo con rodamiento de Ø 25.8 mm

**¡Nuevo!**



**1054**  
kit rep. transm. l/cambio Marbella-Terra  
5 vel. con rodamiento de Ø 25.8 mm



**349**  
fuelle lado cambio Marbella-Terra 4 velocids.  
r.o. SE-022141931A



**583**  
fuelle lado cambio Marbella-Terra 5 velocids.  
r.o.



**1455**  
kit rep. transmisión l/cambio Terra Diesel  
r.o. SE-171498201D



**176**  
capuchón lado cambio Panda y Trans  
r.o. SE-128141531A



**1257**  
fuelle derecho cremallera dirección  
r.o. SE-138162132A



**1258**  
fuelle izquierdo cremallera dirección  
r.o. SE-138162131A



**477**  
juego anillos apoyo palanca de cambio  
Panda y Trans, r.o.



**3724**  
rótula palanca de cambio Terra Diesel  
r.o.



**478**  
juego casquillos palanca de cambio  
r.o.

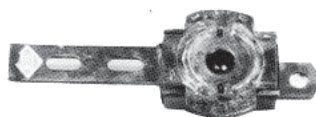

**717**  
tirante elástico mando cambio desde '86  
r.o. SE-141153206A



**585**  
baquelita bomba de gasolina  
r.o. SE-020020021A



**243**  
soporte tubo de escape Panda y Trans  
r.o. SE-138393770



**156**  
soporte tubo de escape todos mods.  
r.o. SE-127115138A



**390**  
collarín colector de escape (con espárragos  
soldados), r.o. SE-127115110A - 112A



**749**  
collarín colector de escape Terra Diesel  
Ø69mm, r.o.

## SEAT PANDA - MARBELLA - TRANS - TERRA



**165**  
soporte tubo de escape Marbella y Terra  
r.o. SE-138115514A



**238**  
soporte tubo de escape Terra Diesel  
r.o.

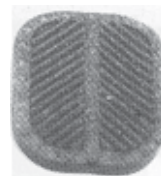

**411**  
cubrepedal freno y embrague  
r.o. SE-141168005B



**675**  
tapón cárter de aceite Panda-Trans, exágo-  
no exterior, Ø 22 M-150, r.o.



**676**  
tapón cárter de aceite Panda-Trans, exágo-  
no interior, Ø 22 M-150, r.o.



**674**  
tapón cárter de aceite Marbella-Terra  
Ø 14 M-150, r.o.



**245**  
goma varilla nivel aceite  
r.o. SE-020030136A



**289**  
casquillo cremallera dirección  
r.o. SE-022162130A

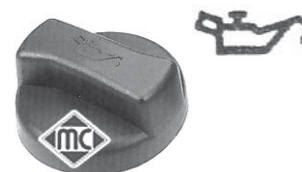

**3621**  
tapón llenado aceite motor TERRA D  
r.o.

## CANALIZACIONES DE AGUA:

**TOLEDO 1.6 carburador motores EZ-ABN desde '91 hasta '94**

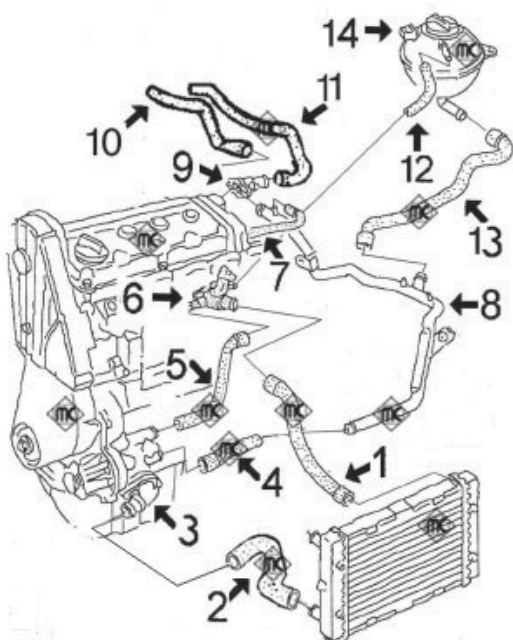

- 1- 7342 mgto superior radiador
- 2- 7343 mgto inferior radiador
- 3- 3536 tapa de termostato
- 4- 7993 mgto de bomba de agua a tubo metálico
- 5- 7715 mgto de bomba a brida en culata
- 6- 3522 tapa de agua conexión manguitos
- 7- 8381 juego de mgtos de tubo a colector admisión
- 8- 3079 tubo de agua metálico
- 9- 3517 boquilla (plástico) en culata
- 10- 8395 mgto de tubo metálico a calefactor
- 11- 8050 mgto de culata a calefactor
- 12- 116 mgto de sobrante de botella a radiador: Cortar de rolo MC-116 Ø 8x14 mm, long. aprox 610 m
- 13- 8378 mgto de botella a tubo metálico
- 14- 3504 botella de expansión
- 3506 tapón botella de expansión

8225 mgto desvaporizador

**TOLEDO 1.6 motor inyección 1F desde '91 hasta '98 (excepto motor AFT de 100cv)**  
**1.8 motores inyección RP-ABS desde '91 hasta '94**  
**1.8 motor inyección ADZ desde '94 hasta '98**  
**1.8 motor inyección ACC desde '95 hasta '98**

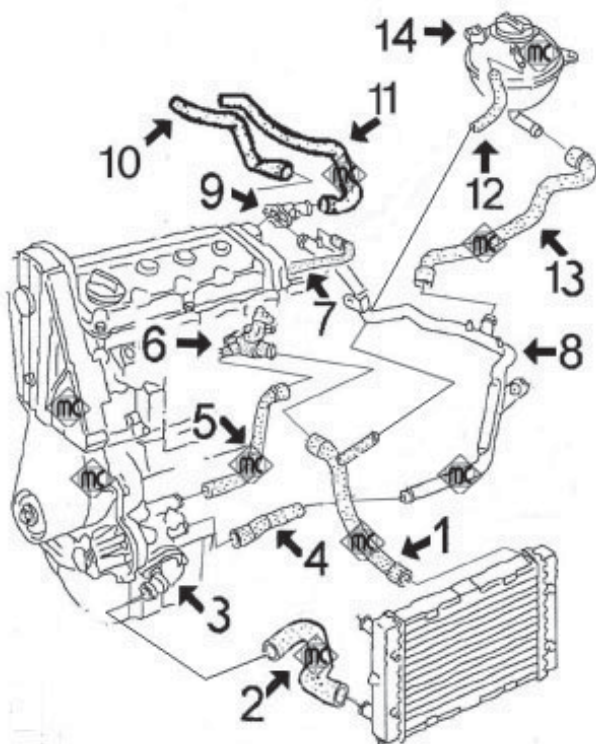

- 1- 7342 mgto sup. radiador 1.6i sin aire acondic. hasta '93
- 8191 mgto sup. radiador 1.6i con aire acond. hasta '93
- 8191 mgto sup. radiador 1.8 hasta '93
- 8387 mgto sup. radiador 1.6i-1.8 desde '93 sin aire acond.
- 8388 mgto sup. radiador 1.6-1.8 desde '93 con aire acond.
- 2- 7343 mgto inferior radiador 1.6 sin aire acond. hasta '93
- 7341 mgto inferior radiador 1.6 con aire acond. y 1.8 todos hasta '93
- 8406 mgto inferior radiador 1.8 sin aire acond. desde '93
- 8453 mgto inferior radiador 1.6i-1.8 con aire acond. d/ '93
- 3- 3536 tapa de termostato
- 4- 7993 mgto de bomba de agua a tubo metálico hasta '93
- 8386 mgto de bomba de agua a tubo metálico desde '93
- 5- 7715 mgto de bomba a tapa en culata hasta '93
- 8383 mgto de bomba a tapa en culata desde '93
- 6- 3522 tapa de agua en culata conexión mgto 1.6i
- 3535 tapa de agua en culata conexión mgto 1.8
- 7- 8391 mgto de tubo metálico a colector
- 8- 3079 tubo de agua metálico hasta '93
- 3084 tubo de agua metálico desde '93
- 9- 3517 boquilla (plástico) en culata
- 10- 8395 mgto de tubo metálico a calefactor
- 11- 8050 mgto de culata a calefactor
- 12- 116 mgto de sobrante de botella a tapa en culata: Cortar de rolo MC-116 Ø 8x14 mm, long. aprox 610 m
- 13- 8378 mgto de botella a tubo metálico
- 14- 3504 botella de expansión
- 3506 tapón botella de expansión

8225 mgto desvaporizador 1.6i

8226 mgto desvaporizador 1.6i - 1.8



## SEAT TOLEDO - 1 (1991-1998)

**TOLEDO 1.8-16v. motores KR y PL hasta '94**  
**2.0-16v. motor ABF hasta '98**

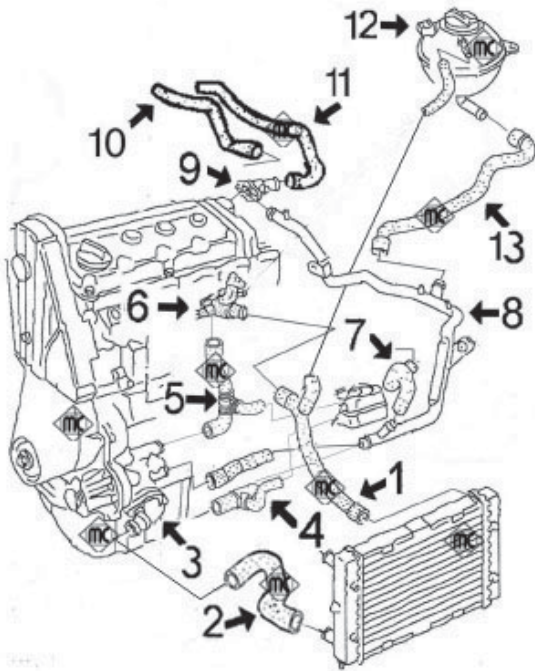

- |     |      |  |
|-----|------|--|
| 1-  | n/d  | mgto superior radiador 1.8-16v                 |
|     | n/d  | mgto superior radiador 2.0-16v                 |
| 2-  | 7341 | mgto inferior radiador 1.8-16v                 |
|     | 8453 | mgto inferior radiador 2.0-16v                 |
| 3-  | 3536 | tapa de termostato                             |
| 4-  | 7993 | mgto de bomba de agua a tubo metálico 1.8-16v  |
|     | 8384 | mgto de bomba de agua a tubo metálico 2.0-16v  |
| 5-  | 7920 | mgto de bomba a tapa en culata 1.8-16v         |
|     | 8414 | mgto de bomba a tapa en culata 2.0-16v         |
| 6-  | 3582 | tapa de agua conexión manguitos 1.8-16v        |
|     | n/d  | tapa de agua conexión manguitos 2.0-16v        |
| 7-  | 7994 | mgto de intercambiador a tubo metálico 1.8-16v |
| 8-  | 3083 | tubo de agua metálico 1.8-16v                  |
|     | 3095 | tubo de agua metálico 2.0-16v                  |
| 9-  | 3583 | boquilla en culata                             |
| 10- | 8395 | mgto de tubo metálico a calefactor             |
| 11- | 8050 | mgto de culata a calefactor 1.8-16v            |
|     | 8396 | mgto de culata a calefactor 2.0-16v            |
| 12- | 3504 | botella de expansión                           |
|     | 3506 | tapón botella de expansión                     |
| 13- | 8378 | mgto de botella a tubo metálico                |

**TOLEDO 1.6 motor AFT de 100cv desde '96 hasta '98**  
**2.0 motor 2E desde '91 hasta '96**  
**2.0 motor AGG desde '96 hasta '98**

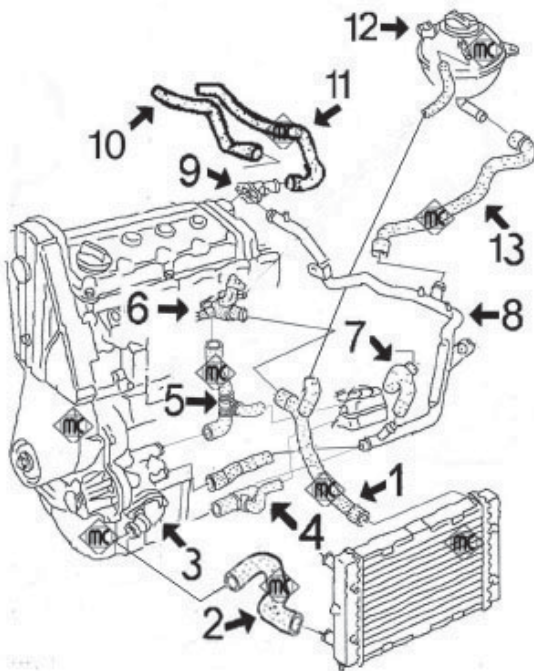

- |     |      |  |
|-----|------|--|
| 1-  | 8191 | mgto superior radiador 2.0 hasta '93             |
|     | 8387 | mgto superior radiador 2.0 desde '93             |
| 2-  | 7341 | mgto inferior radiador                           |
| 3-  | 3536 | tapa de termostato                               |
| 4-  | 7993 | mgto de bomba de agua a tubo metálico hasta '93  |
|     | 8384 | mgto de bomba de agua a tubo metálico desde '93  |
| 5-  | 8394 | mgto de bomba a tapa en culata                   |
| 6-  | 3522 | tapa de agua conexión manguitos                  |
| 7-  | 7994 | mgto de intercambiador a tubo metálico hasta '93 |
| 8-  | 3083 | tubo de agua metálico hasta '93                  |
|     | 3095 | tubo de agua metálico desde '93                  |
| 9-  | 3517 | boquilla en culata 2.0                           |
|     | 3589 | boquilla en culata 1.6-100cv (AFT)               |
| 10- | 8395 | mgto de tubo metálico a calefactor               |
| 11- | 8050 | mgto de culata a calefactor hasta '93            |
|     | 8396 | mgto de culata a calefactor desde '93            |
| 12- | 3504 | botella de expansión                             |
|     | 3506 | tapón botella de expansión                       |
| 13- | 8378 | mgto de botella a tubo metálico                  |

- |      |                     |
|------|---------------------|
| 8224 | mgto desvaporizador |
| 8229 | mgto desvaporizador |

## SEAT TOLEDO - 1 (1991-1998)

### TOLEDO 1.9 Diesel motor 1Y desde '91 hasta '97 1.9 TurboDiesel motor AAZ desde '91 hasta '94 (NO "TDi")

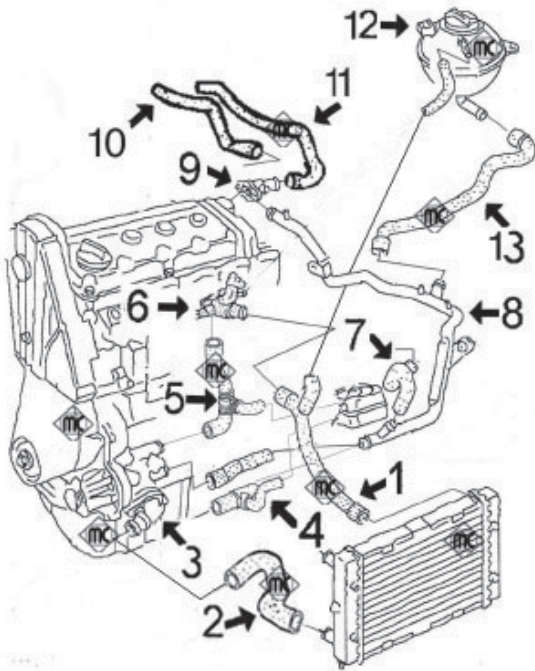

- 1- 8387 mgto superior radiador sin aire acondicionado  
8379 mgto superior radiador con aire acondicionado
- 2- 7341 mgto inferior radiador sin aire acond. hasta '93  
8831 mgto inferior radiador con aire acond. hasta '93  
8453 mgto inferior radiador desde '93
- 3- 3537 tapa de termostato  
3667 tapa de termostato completa con boquilla a 90°
- 4- 7993 mgto de bomba agua a tubo metálico hasta '93  
8384 mgto de bomba agua a tubo metálico desde '93
- 5- 8382 mgto de bomba de agua a racor en culata y a intercambiador en filtro de aceite
- 6- 3527 tapa de agua en culata conexión manguitos
- 7- 7994 mgto de tubo metálico a intercambiador hasta '93
- 8- 3083 tubo de agua metálico hasta '93  
3084 tubo de agua metálico desde '93
- 9- 3517 boquilla e culata
- 10- 8395 mgto de tubo metálico a calefactor
- 11- 8050 mgto de culata a calefactor hasta '93  
8396 mgto de culata a calefactor desde '93
- 12- 3504 botella de expansión  
3506 tapón botella de expansión
- 13- 8378 mgto de botella a tubo metálico

8385 mgto desvaporizador

### TOLEDO 1.9 TDi motores 1Z - AHU - AFN desde '94 hasta '98

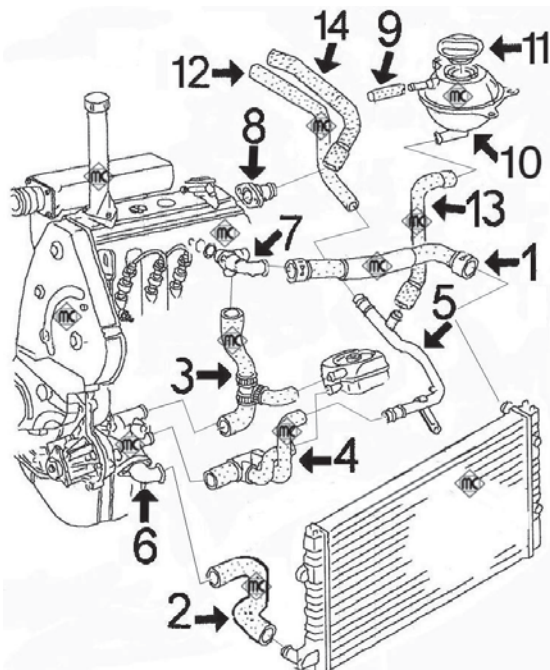

- 1- 7342 mgto superior radiador sin aire acondicionado  
8389 mgto superior radiador con aire acondicionado
- 2- 8406 mgto inferior radiador sin aire acondicionado  
8399 mgto inferior radiador con aire acondicionado
- 3- 8382 mgto de bomba de agua a racor en culata y a intercambiador filtro de aceite
- 4- 8384 mgto de bomba agua a tubo metálico
- 5- 3094 tubo de agua metálico
- 6- 3537 tapa de termostato  
3667 tapa de termostato completa con boquilla a 90°
- 7- 3542 tapa de agua en culata conexión manguitos
- 8- 3517 boquilla en culata conexión mgto calefactor
- 9- 116 mgto de sobrante de botella a tapa en culata: Cortar de rollo MC-116 Ø 8x14 mm, long. aprox 610 m
- 10- 3504 botella de expansión
- 11- 3506 tapón botella de expansión
- 12- 8395 mgto de tubo metálico a calefactor
- 13- 8378 mgto de botella a tubo metálico
- 14- 8396 mgto de boquilla en culata a calefactor

8385 mgto desvaporizador

TUBOS DESVAPORIZADORES 1.9D - TD - TDi - SDi:

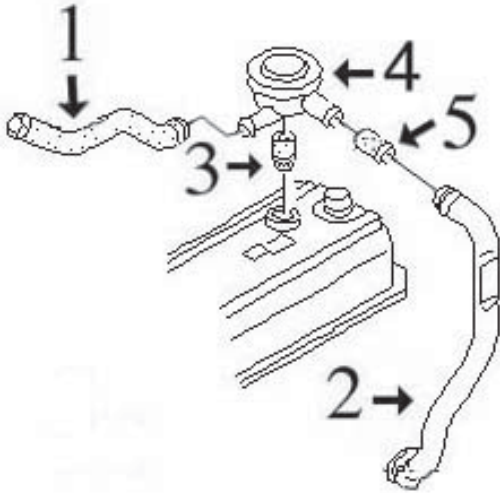

- 1- 8895 mgto de válvula desvaporizadora 1.9TDi
- 8385 mgto de válvula desvaporizadora 1.9D-TD
- 2- 3644 tubo plástico de válvula a cárter
- 3- 2669 junta válvula desvaporizadora
- 4- 3719 válvula desvaporizadora
- 5- 8385 mgto desvaporizador 1.9D-TD (no TDi!)



## SEAT TOLEDO - 1 (1991-1998)



**7341**  
mgto inferior radiador 1.6-1.8-1.9D-TD y  
16v., r.o. 191121051P



**7342**  
mgto superior radiador 1.6 sin aire acond.  
r.o. 191121101S



**7343**  
mgto inferior radiador 1.6 sin aire ac.  
r.o. 191121051F



**7715**  
mgto de bomba de agua a racor en culata  
1.6-1.8 (salvo 16v.), r.o. 026121053G

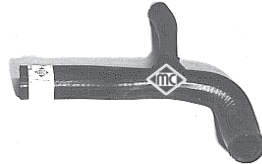

**7920**  
mgto de bomba a racor en culata 2.0  
r.o. 027121053B



**7987**  
mgto de bomba a racor en culata 1.9D-TD  
r.o. 068121053P



**7993**  
mgto de bomba de agua a tubo metálico  
r.o. 068121063M



**7994**  
mgto de tubo metálico a intercambiador  
16v.-D-TD y 2.0, r.o. 037121058A



**8050**  
mgto de bloque a calefactor 1.6 hasta '93  
r.o. 191819373D



**8191**  
mgto superior radiador 1.6 con aire ac., 1.8,  
(salvo 16v.), D-TD y 2.0, r.o. 1L0121101B



**8224**  
mgto desvaporizador 1.6-1.8 con cataliz.  
r.o. 051103493A



**8225**  
mgto desvaporizador 1.6-1.8 sin catalizador  
r.o. 051103493



**8228**  
mgto desvaporizador 2.0  
r.o. 037103493AB-037103211



**8229**  
mgto desvaporizador 2.0  
r.o. 037103493P



**8377**  
mgto depresor servofreno todos mods.  
r.o. 321611939E



**8378**  
mgto de botella a tubo metálico todos mods.  
r.o. 1H0121109-535121109-1H0121109A



**8379**  
mgto superior radiador Diesel y TurboD  
con aire ac. hasta '93, r.o. 1L0121101

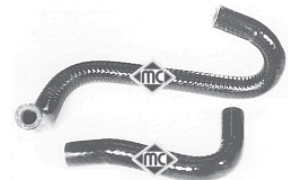

**8381**  
juego mgto del colector 1.6 carburador  
r.o. 026121062C+037121057



**8382**  
mgto de bomba a brida culata D-TD-TDi  
r.o. 028121053Q/L/S/P

















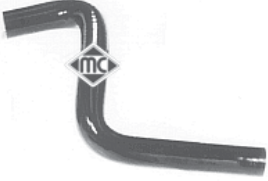





**8383**  
mgto de bomba a brida en culata 1.6-1.8  
con catalizador, r.o. 037121053H



**8384**  
mgto de bomba a intercambiador y tubo  
r.o. 037122058-037121058B-037122058B



## SEAT TOLEDO - 1 (1991-1998)

 <p><b>8385</b> mgto desvaporizador 1.9D-TD r.o.028103493E</p>	 <p><b>8386</b> mgto de bomba a tubo metálico 1.6-1.8 desde '93, r.o.037121063A</p>	 <p><b>8387</b> mgto superior radiador Diesel y TD sin aire acondicionado, r.o. 1L0121101P</p>
 <p><b>8389</b> mgto superior radiador TDi con aire ac. r.o. 1L0121101R</p>	 <p><b>8391</b> mgto de tubo metálico a colector 1.6-1.8 desde '93, r.o.051121056</p>	 <p><b>8394</b> mgto bomba-culata 1.6-2.0 y 16v d/ '93 r.o.037121053G-037121053J-037121036</p>
 <p><b>8395</b> mgto de tubo metálico a calefactor r.o. 1H0819373C</p>	 <p><b>8396</b> mgto de culata a calefactor r.o. 1H0819371</p>	 <p><b>8399</b>      Ø bocas 32-32 mm mgto inferior radiador TDi r.o. 1L0121051N</p>
 <p><b>8406</b> mgto inferior radiador Diesel y TurboD desde '93 sin aire ac., r.o. 1L0121051A</p>	 <p><b>8414</b> mgto de bomba a culata 2.0-16v r.o.037121053K</p>	 <p><b>8453</b> mgto inferior radiador Diesel y TurboD desde '93 con aire ac., r.o. 1L0121051C</p>
 <p><b>8831</b>      Ø bocas 32-38 mm mgto inferior radiador D-TD aire acond. r.o.</p>	 <p><b>8895</b> mgto desvaporizador 1.9 TDi r.o.028103493S</p>	 <p><b>2669</b> junta válvula desvaporizadora Diesel r.o.028103500</p>
 <p><b>3079</b> tubo de agua metálico 1.6-1.8 r.o.027121065C-037121065</p>	 <p><b>3083</b> tubo de agua metálico Diesel-1.8 16v y 2.0, r.o.027121065D/E-028121065A</p>	 <p><b>3084</b> tubo de agua metálico 1.6-2.0-D y TD d/'93 r.o.037121065K/L/G/H</p>
 <p><b>3094</b> tubo de agua metálico TDi r.o.028121065K-028121065T</p>	 <p><b>3095</b> tubo de agua metálico 2.0-16v r.o.037121065J</p>	

SEAT TOLEDO - 1 (1991-1998)



**3504**  
botella de expansión con sensor de nivel  
r.o. 1H0121407A



**3506**  
tapón botella de expansión  
r.o. 1H0121321A



**3517**  
boquilla en culata empalme tubo calefact.  
r.o.026121144A-037121145-026121145E



**3535**  
brida en culata conexión mgts 1.6-1.8  
r.o.037121133B-037121132B



**3522**  
brida en culata conexión mgts 1.6-1.8  
r.o.037121133F-037121132E-037121132G



**3527**  
brida en culata conexión mgts D-TD  
r.o.068121133AB/AE/AF



**3542**  
brida en culata conexión mgts. TDI  
r.o.028121132A



**3536**  
tapa de termostato 1.6-1.8-2.0 gasolina y Diesel hasta '93, r.o.055121121F



**3537**  
tapa de termostato Diesel y TD d/ '93 y TDi, r.o.037121121A+1H0121687



**3540**  
kit tapón cierre alojamiento sensores  
r.o.357121140+032121142+N90316802



**3582**  
tapa de agua en culata (frontal) 1.8-16v.  
r.o.027121133E



**3583**  
tapa de agua en culata (lateral) 1.8-16v  
r.o.027121145B



**3589**  
boquilla en culata (lateral) 1.6-100cv (AFT)  
r.o.037121145F-037121144H

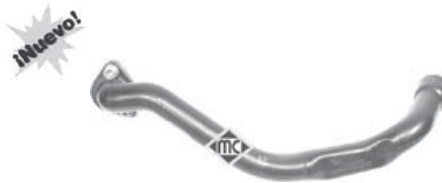

**3644**  
tubo desvaporizador 1.9D-TD-TDi-SDi  
r.o.028103491J



**3667**  
tapa de termostato 1.6-1.8-2.0-D-TD-TDi completa con codo,037121121A+037121619



**3719**  
válvula desvaporizadora 1.9D-TD-TDi  
r.o.028109121D





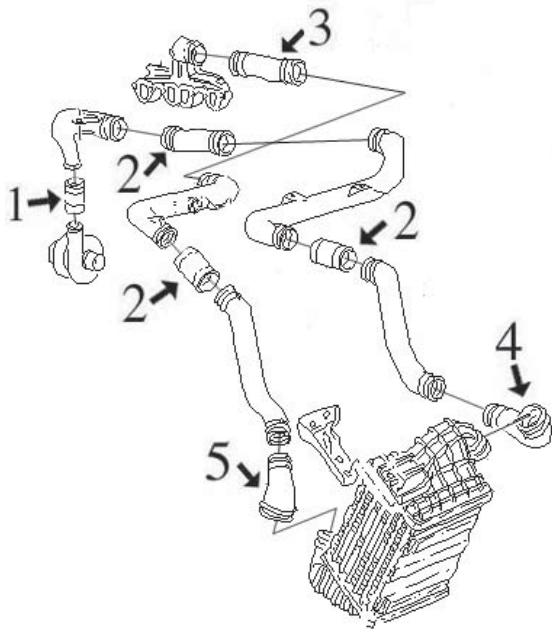

CANALIZACIONES de AIRE de ALTA PRESION INTERCOOLER-TURBO:

TOLEDO-I 1.9 Diesel motores TDi desde 9/'95 a 3/'99  
(AHU-1Z-AFN-ALE)



- 1- 9062 tubo flexible de empalme salida Turbo
- 2- 9061 tubo flexible de empalme
- 3- 9060 tubo flexible de colector de aspiración a tubo
- 4- 9059 tubo flexible de intercooler a tubo rígido
- 5- 9058 tubo flexible de intercooler a tubo rígido

<p><b>¡Nuevo!</b></p>  <p><b>9058</b> tubo flexible de intercooler a tubo rígido r.o. 1L0145832C</p>	<p><b>¡Nuevo!</b></p>  <p><b>9059</b> tubo flexible de intercooler a tubo rígido r.o. 1L0145834B</p>	<p><b>¡Nuevo!</b></p>  <p><b>9060</b> tubo flexible de colector de aspiración r.o. 1H0145838G</p>
<p><b>¡Nuevo!</b></p>  <p><b>9061</b>      Ø 50x60 largo 58 mm tubo flexible de empalme r.o. 1H0145834E</p>	<p><b>¡Nuevo!</b></p>  <p><b>9062</b>      Ø 35x45 largo 58 mm tubo flexible de empalme salida Turbo r.o. 1H0145972</p>	

SUSPENSION DELANTERA y SOPORTES DE MOTOR:

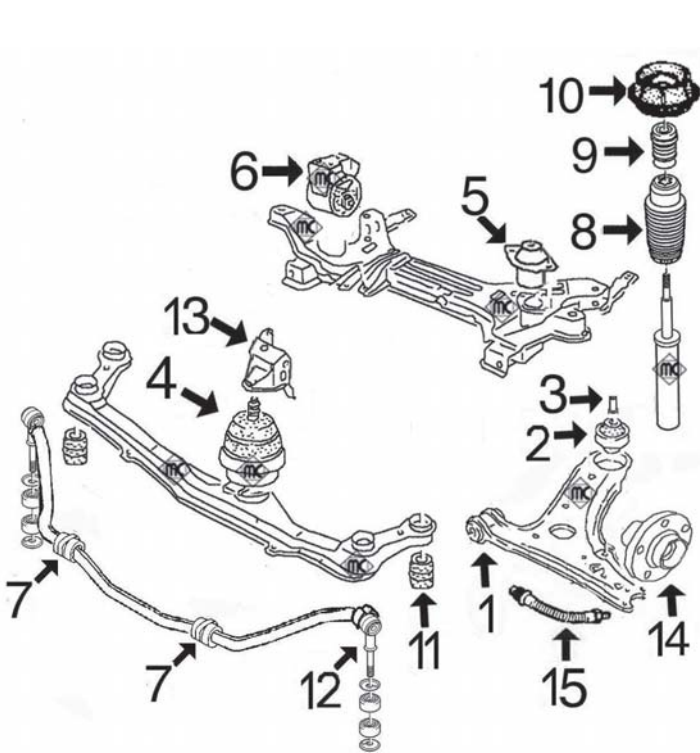

- 1- 542 silentbloc anterior trapezio delantero
- 2- 543 silentbloc posterior trapezio delantero
- 3- 2822 casquillo eje silentbloc posterior trapezio
- 4- 848 soporte motor delantero 1.9D-TD (no TDi)
- 849 soporte motor delantero 1.6-1.8-1.8/16v
- 2685 soporte motor delantero TDi-2.0/16v y 1.6-100cv
- 5- 846 soporte motor trasero izquierdo 1.6 (salvo 100cv)
- 987 soporte motor trasero izquierdo 1.9 D-TD (no TDi)
- 4366 soporte motor trasero izquierdo TDi
- 4362 soporte motor trasero izquierdo 1.6-100cv (AFT)
- 6- 847 soporte motor trasero derecho salvo 16v y TDi
- 4127 soporte motor trasero derecho 1.8-16v
- 2686 soporte motor trasero derecho TDi-2.0/16 v y 1.6-100cv (AFT)
- 7- 917 goma para barra estabilizadora de Ø 18 mm
- 4266 goma para barra estabilizadora de Ø 20 mm
- 8- 4324 capuchón amortiguador delantero desde '95
- n/d capuchón amortiguador delantero hasta '95
- 9- 712 tope de amortiguador hasta '95 (goma)
- 4254 tope de amortiguador desde '95 (poliuretano)
- 10- 896 soporte amortiguador delantero hasta '95
- 2812 soporte amortiguador delantero desde '95
- 11- 2444 silentbloc soporte travesía delantera
- 12- 646 bieleta puntal barra estabilizadora hasta '95
- 2852 bieleta barra estabilizadora desde '95 salvo 2.0-16v
- 4336 bieleta puntal barra estabilizadora 2.0-16v
- 13- 4129 anclaje metálico del soporte motor delantero salvo TDi-2.0/16v y 1.6-100cv (AFT)
- 14- 90035 buje rueda delantera todos salvo 2.0-16v
- 90048 buje rueda delantera 2.0-16v
- 15- 96179 latiguillo freno delantero (360 mm)

SUSPENSION TRASERA:

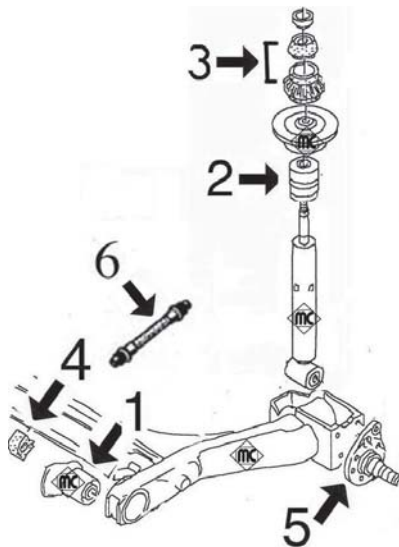

- 1- 924 silentbloc brazo trasero suspensión salvo 2.0-16v
- 2856 silentbloc brazo trasero suspensión 2.0-16v
- 2- 2811 tope poliuretano amortiguador trasero
- 3- 4320 juego soportes amortiguador
- 4- 2824 goma barra estabilizadora
- 5- 90516 mangueta rueda trasera, freno de tambor sin ABS
- 90539 mangueta rueda trasera izquierda, tambor con ABS
- 90540 mangueta rueda trasera derecha, tambor con ABS
- 90541 mangueta rueda trasera izquierda, freno de disco
- 90542 mangueta rueda trasera derecha, freno de disco
- 6- 96111 latiguillo freno trasero (racores hembra-hembra) longitud 160 mm
- 96175 latiguillo freno trasero (racores hembra-macho) longitud 190 mm



**542**  
silentbloc posterior trapezio delantero  
r.o. 191407182E















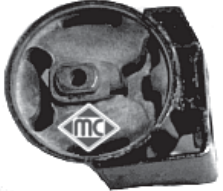

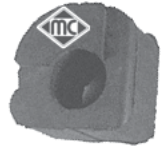
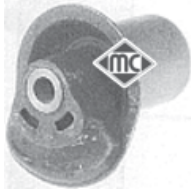

**543**  
silentbloc anterior trapezio delantero  
r.o. 191407181A



**646**  
bieleta barra estabilizadora hasta '95  
r.o. 191411315

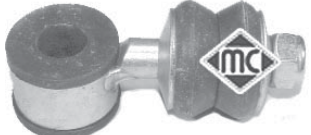
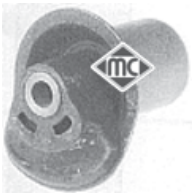

## SEAT TOLEDO - 1 (1991-1998)

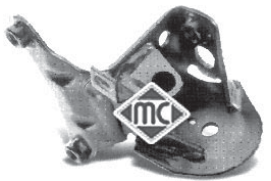
 <p><b>712</b> tope de goma amortiguador delt. hasta '95 r.o. 191412303A</p>	 <p><b>846</b> vaso Ø 64 mm soporte de motor trasero izquierdo 1.6 r.o. 191199402 - 191199402A</p>	 <p><b>847</b> soporte de motor trasero derecho salvo 16v y TDi, r.o. 191199262A</p>
 <p><b>848</b> soporte de motor delantero 1.9D y TD r.o. 191199279C - 357199279B</p>	 <p><b>849</b> soporte de motor delantero 1.6/1.8/2.0 r.o. 191199279E</p>	 <p><b>896</b> con rodamiento soporte amortiguador delantero hasta '94 r.o. 191412329 - 811412365</p>
 <p><b>917</b> goma para barra estabilizadora de Ø 18 mm r.o. 191411314</p>	 <p><b>924</b> Ø 44 mm silentbloc brazo suspensión trasera hasta '95 r.o. 191501541</p>	 <p><b>987</b> vaso Ø 73 mm soporte de motor trasero izquierdo 1.9D-TD(no TDi), r.o. 357199402B</p>
 <p><b>2444</b> silentbloc soporte traviesa delantera r.o. 191199233</p>	 <p><b>2685</b> soporte de motor delantero TDi, 1.6-100cv y 2.0-16v, r.o. 1H0199609F/E</p>	 <p><b>2812</b> con rodamiento soporte amortiguador delantero desde '95 r.o. 357412331A</p>
 <p><b>2686</b> soporte de motor trasero derecho TDi, 1.6-100cv y 2.0-16v, r.o. 1H0199262A</p>	 <p><b>2811</b> tope poliuretano suspensión trasera r.o. 191512131B</p>	 <p><b>2822</b> casquillo eje silentbloc anterior trapecio r.o. 191407190A</p>
 <p><b>2824</b> goma barra estabilizadora trasera r.o. 871511423</p>	 <p><b>2852</b> bieleta barra estabilizadora desde '95 r.o. 191411315A</p>	 <p><b>2856</b> Ø 56,5 mm silentbloc brazo suspensión trasera d/ '94 r.o. 1H0501541 - 1H0501541A</p>
 <p><b>4127</b> soporte motor trasero derecho 1.8-16v r.o. 535199262</p>	 <p><b>4129</b> anclaje metálico soporte motor delantero salvo TDi y 2.0-16v, r.o. 191199273C</p>	

## SEAT TOLEDO - 1 (1991-1998)

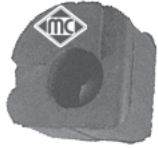

**4266**  
goma para barra estabilizadora de Ø 20 mm  
r.o. 1H0411314



**4254**  
tope amortiguador delantero desde '95  
r.o. 357412303F

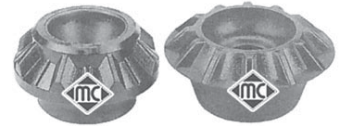

**4320**  
jgo soportes fijación amortiguador trasero  
r.o. 191512333+191512335



**4324**  
capuchón amortiguador delt. desde '95  
r.o. 357413175A



**4336**  
bioleta puntal barra estabilizadora 2.0-16v  
r.o. 535411315



**4362**  
soporte motor trasero izquierdo 1.6-100cv  
(motor AFT), r.o. 357199402B-3A0199402



**4366**  
soporte motor trasero izquierdo TDi  
r.o. 357199381C



**90035**  
buje rueda delantera todos salvo 2.0-16v  
(Ø120mm), r.o. 357407613B



**90048**  
buje rueda delantera 2.0-16v (Ø 127 mm)  
r.o. 1H0407613B



**90516**  
mangueta rueda trasera, tambor sin ABS  
r.o. 357501117



**90539**  
mangueta rueda trasera **izqda.**, tambor  
con ABS, r.o. 333501117A



**90540**  
mangueta rueda trasera **dcha.**, tambor  
con ABS, r.o. 333501118A



**90541**  
mangueta rueda trasera **izquierda**, freno  
de disco, r.o. 333501117



**90542**  
mangueta rueda trasera **derecha**, freno  
de disco, r.o. 333501118



**96179**  
latiguillo freno delantero (360 mm)  
r.o. 1L0611701



**96111**  
latiguillo freno trasero (racores hembra-  
hembra, long. 160 mm), r.o. 171611775



**96175**  
latiguillo freno trasero (racores hembra-  
macho, long 190 mm), r.o. 481611775

## SEAT TOLEDO - 1 (1991-1998)

 <p><b>2813</b> varilla selectora de velocidades salvo TDi y 2.0-16v, r.o. 191711574</p>	 <p><b>947</b> <span style="float: right;"><b>largo 74 mm</b></span> bieteleta cambio de velocidades hasta '96 salvo TDi y 2.0-16v, r.o. 191711595A</p>	 <p><b>2879</b> <span style="float: right;"><b>largo 60 mm</b></span> bieteleta cambio de velocidades desde '96 salvo TDi y 2.0-16v, r.o. 1H0711595</p>
 <p><b>2840</b> juego reparación palanca de cambio salvo TDi y 2.0-16v, r.o. 191711173B+171711067B</p>	 <p><b>4184</b> guía-soporte barra cambio salvo TDi y 2.0-16v, r.o. 191711083</p>	 <p><b>4141</b> péndulo selector velocidades TDi y 2.0-16v, r.o. 1L0711051</p>
 <p><b>4024</b> <span style="float: right;"><b>long. 306 mm</b></span> palanca de cambio salvo TDi y 16v r.o. 191711116C</p>	 <p><b>3691</b> articulación cambio 1.9TDi y 2.0-16v r.o. 1J0711256</p>	 <p><b>4749</b> guia embrague con retén 1.9D-TD-TDi y 2.0-16v, r.o. 02A141180A</p>
 <p><b>4772</b> juego palanca de desembrague 1.6-1.8-2.0-1.9D y TD, r.o. 02K141709A+020141723C</p>	 <p><b>4906</b> varilla empujadora embrague (341 mm) r.o. 020141709B</p>	 <p><b>2854</b> tope punta cable embrague r.o. 1H0798303A</p>
 <p><b>3724</b> juego reparación rótula palanca de cambio salvo TDi y 2.0-16v, r.o. 191711251A</p>	 <p><b>3687</b> cubierta correa distribución 1.6 hasta '95 r.o. 26109175A</p>	 <p><b>3715</b> cubierta correa distribución 1.6-1.8 desde '95, r.o. 026109107B</p>
 <p><b>3681</b> cubierta correa distribución 1.6-1.8-2.0 hasta '98, r.o. 026109173A</p>	 <p><b>4768</b> <span style="float: right;"><b>Ø 78 mm</b></span> rodillo tensor correa alternador r.o. 028145278E</p>	 <p><b>4290</b> polea cigüeñal Diesel-TurboD y TDi r.o. 028105243T-028105243K</p>
 <p><b>4908</b> tensor correa alternador 1.9D-TD-TDi r.o. 028903315R</p>	 <p><b>4909</b> tensor correa alternador 1.6-1.8-2.0 gasolina r.o. 037903315C</p>	



SEAT TOLEDO - 1 (1991-1998)



**1359**  
kit fuelle transmisión l/rueda 1.6 - 1.9 D  
hasta '94, r.o. 191498203

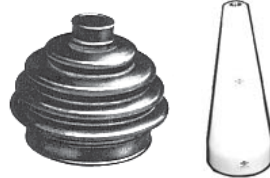

**1359-E** para montar con cono  
kit fuelle transmisión l/rueda 1.6 - 1.9 D  
hasta '94, r.o. 191498203



**1575**  
kit fuelle transm. l/rueda 1.8-2.0 y TurboD  
hasta '94, r.o. 191498203C

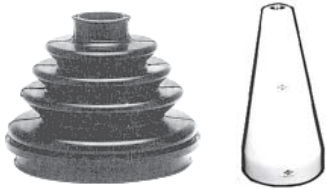

**1575-E** para montar con cono  
kit fuelle transm. l/rueda 1.8-2.0 y TurboD  
hasta '94, r.o. 191498203C



**1921**  
kit fuelle transmisión l/rueda todos salvo  
16v d/'94 (Ø 26-78 mm), r.o. 1H0498203A



**1297**  
kit fuelle transmisión l/rueda 2.0-16v  
(Ø 25-86 mm), r.o. 191498203C



**1560**  
kit fuelle transm. izqd. l/cambio 1.8-2.0-TD  
(Ø 24-100 mm) hasta '96, r.o. 191498201B



**1637**  
kit fuelle transm. dcha. l/cbo 1.8-2.0-TD  
(Ø 24-100 mm) hasta '96, r.o. 191498202A



**1455**  
kit fuelle transmisión l/cambio 1.8-1.9 D  
(Ø 24-94 mm), r.o. 191498201D

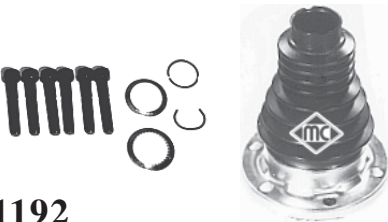

**1192**  
kit fuelle transmisión l/cambio 1.8-2.0-TD  
(Ø 27-100 mm) desde '96, r.o.



**1106**  
kit fuelle transmisión l/cambio 1.8-2.0-TD  
(Ø 27-94 mm) desde '96, r.o.



**1511**  
fuelle cremallera manual  
r.o. 191419831



**1511-C**  
kit reparación cremallera manual compl.  
r.o.



**1765**  
fuelle cremallera asistida  
r.o. 175422831



**1765-C**  
juego fuelles cremallera asistida  
r.o.



**2309**  
casquillo cremallera manual  
r.o. no hay despiece



**4766**  
guía cerradura maneta puerta  
r.o. 1H0837223B



**2695**  
soporte cuerpo de inyección 1.6 - 1.8  
(monopunto) r.o. 050129761F/B



**2698**  
soporte carburador 1.6 hasta '93  
r.o. 037129761

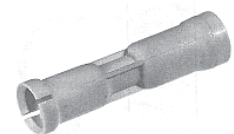

**2448**  
guía varilla nivel aceite (motores de gaso-  
lina), r.o. 053103663



## SEAT TOLEDO - 1 (1991-1998)

 <p><b>016</b> tapón cierre inyectores Diesel r.o.068130229A</p>	<p><i>Nuevo!</i></p>  <p><b>3672</b> válvula filtro gasoil r.o.191127247A</p>	 <p><b>4365</b> jgo. tornillo sujeción tapa cubremotor r.o.028103665+028103937+028103638G</p>
 <p><b>2876</b> guía varilla nivel aceite (motores Diesel) r.o.028103663B</p>	<p><i>Nuevo!</i></p>  <p><b>4760</b> varilla nivel aceite 1.6-1.8-2.0 r.o.027115611C</p>	<p><i>Nuevo!</i></p>  <p><b>4942</b> varilla nivel aceite 1.9D-TD-TDi r.o.028115611C</p>
  <p><b>3621</b> tapón llenado aceite motor r.o.026103485</p>	 <p><b>2779</b> kit sujeción escape a colector 1.6 r.o.161298115</p>	 <p><b>2780</b> junta de colector 1.6-1.8-2.0-D-TD-TDi r.o.028129589B</p>
 <p><b>497</b> soporte tubo de escape hasta '96 r.o.803253147</p>	 <p><b>2766</b> soporte tubo de escape desde '96 r.o.1L0253147</p>	 <p><b>098</b> soporte silenciador trasero r.o.191253147A</p>
 <p><b>674</b> tapón cárter de aceite 14x1.5 r.o.</p>	 <p><b>792</b> tuerca rueda r.o.</p>	 <p><b>2609</b> tuerca autoblocante buje delantero r.o.</p>
 <p><b>864</b> cubrepedal freno y embrague r.o.321721173</p>	<p><i>Nuevo!</i></p>  <p><b>3708</b> tapón de combustible (sin llave) r.o.1J0201553C</p>	<p><i>Nuevo!</i></p>  <p><b>3739</b> interruptor luz de freno (2 polos) r.o.191945515-191545515A/B</p>

## SEAT TOLEDO-2 - LEON (1999-2005)

### CANALIZACIONES DE AGUA:

TOLEDO-2/LEON 1.4/16v  
1.6/8v  
1.6/16v

motores AHW-AXP  
motor APF  
motores AUS-AZD

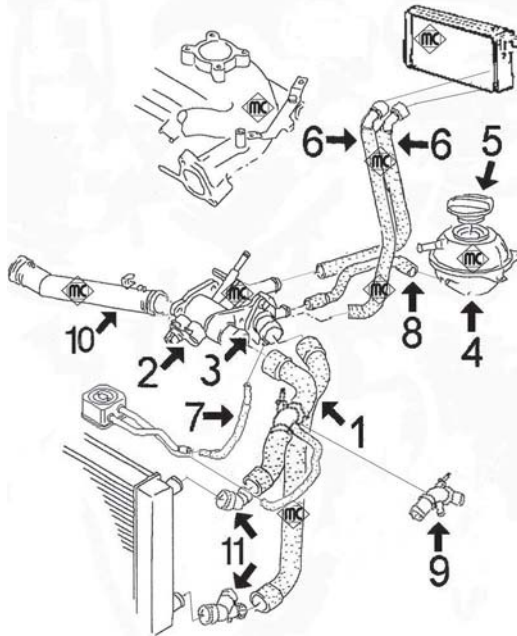

- 1- 9078 mgto doble superior/inferior 1.4/16v completo con conectores rápidos salvo 1.6-APF-AVU
- 9079 mgto doble superior/inferior 1.6/16v completo con conectores rápidos
- 2- 3615 caja de termostato completa
- 3- 3592 kit de termostato completo con tapa y junta salvo 1.6 APF-AVU
- 3541 tapa de termostato salvo 1.6APV-AVU
- 3745 tapa con termostato 1.6 100/102 CV APF-AVU
- 4- 3635 botella de expansión
- 5- 3573 tapón botella de expansión
- 6- 9052 mgto doble de entrada/salida calefactor completo con conectores rápidos
- 7- 9054 mgto de intercambiador a caja termostato (sólo 1.6)
- 8- 9044 mgto de caja termostato a botella
- 9- 3604 conector mgto superior completo con accesorios
- 10- 3625 tubo de agua (plástico) de bomba a caja termostato
- 11- 3721 juego de conectores superior/inferior en mgto radiador
  
- 9055 mgto desvaporizador

TOLEDO-2/LEON 1.6/8v

motores AEH-AKL

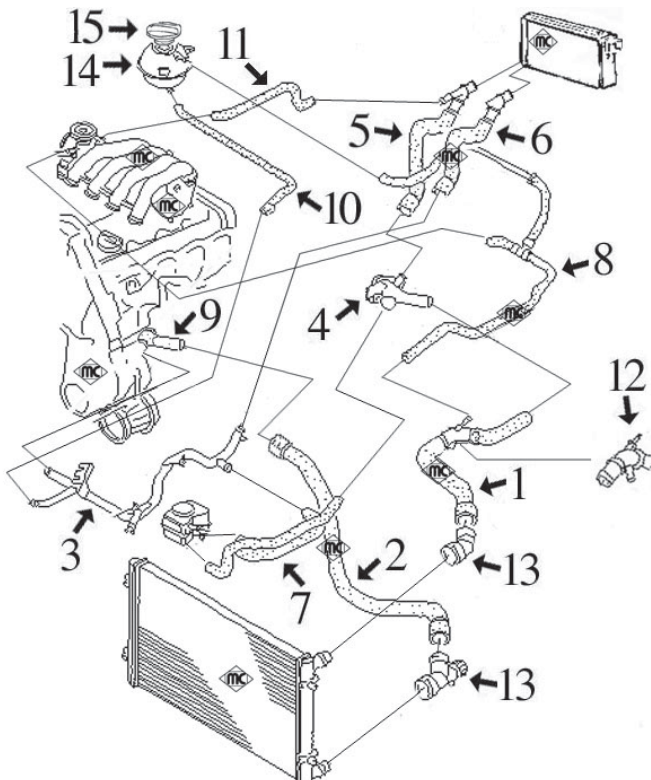

- 1- 9045 mgto superior radiador completo con conector rápido
- 2- 9046 mgto inferior radiador completo con conector rápido
- 3- 3176 tubo de agua metálico completo con junta tórica
- 4- 3598 boquilla (plástico) en culata
- 5- 9051 mgto de calefactor a boquilla en culata (con conector rápido)
- 6- 9042 mgto de calefactor a tubo metálico (con conector rápido)
- 7- 9048 mgto doble de intercambiador en filtro de aceite
- 8- n/d mgto a caja mariposa y reboso botella
- 9- 3597 boquilla en bloque (plástico)
- 10- 9043 mgto de tubo metálico a botella
- 11- n/d mgto de caja mariposa a conector en mgto calefactor
- 12- 3604 conector mgto superior completo con accesorios
- 13- 3721 juego de conectores superior/inferior en mgto radiador
- 14- 3635 botella de expansión
- 15- 3573 tapón botella de expansión

## SEAT TOLEDO-2 - LEON (1999-2005)

**TOLEDO-2/LEON 1.8/20v**

**motores AGN y APG**

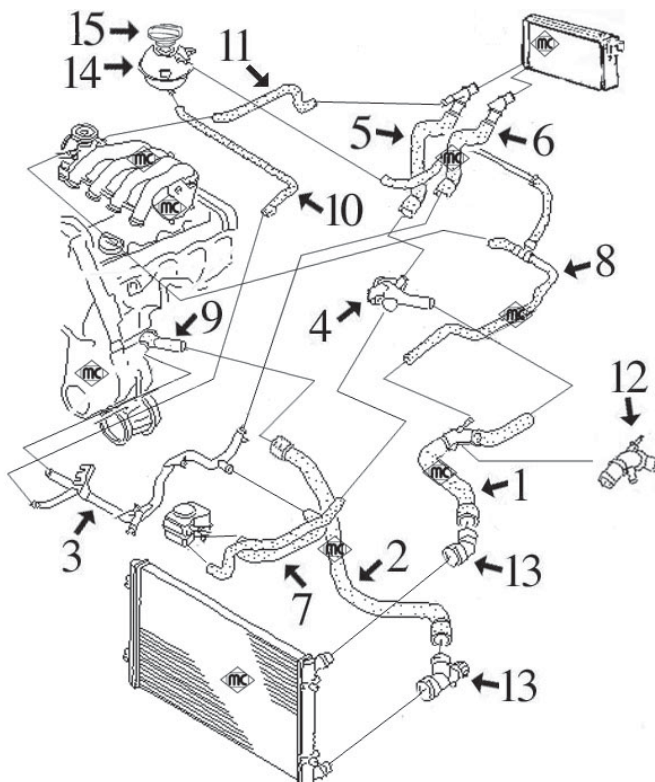

- 1- 9045 mgto superior radiador completo con conector rápido
- 2- 9046 mgto inferior radiador completo con conector rápido
- 3- 3177 tubo de agua metálico completo con junta tórica
- 4- 3598 boquilla (plástico) en culata motor AGN  
3600 boquilla (plástico) en culata motor APG
- 5- 9053 mgto de calefactor a boquilla en culata (con conector rápido)
- 6- 9042 mgto de calefactor a tubo metálico (con conector rápido)
- 7- 9048 mgto doble de intercambiador en filtro de aceite
- 8- n/d mgto a caja mariposa y rebose botella
- 9- 3597 boquilla en bloque (plástico)
- 10- 9043 mgto de tubo metálico a botella
- 11- n/d mgto de caja mariposa a conector en mgto calefactor
- 12- 3604 conector mgto superior completo con accesorios
- 13- 3721 juego de conectores superior/inferior en mgto radiador
- 14- 3635 botella de expansión
- 15- 3573 tapón botella de expansión

**TOLEDO-2/LEON 1.9 Diesel**



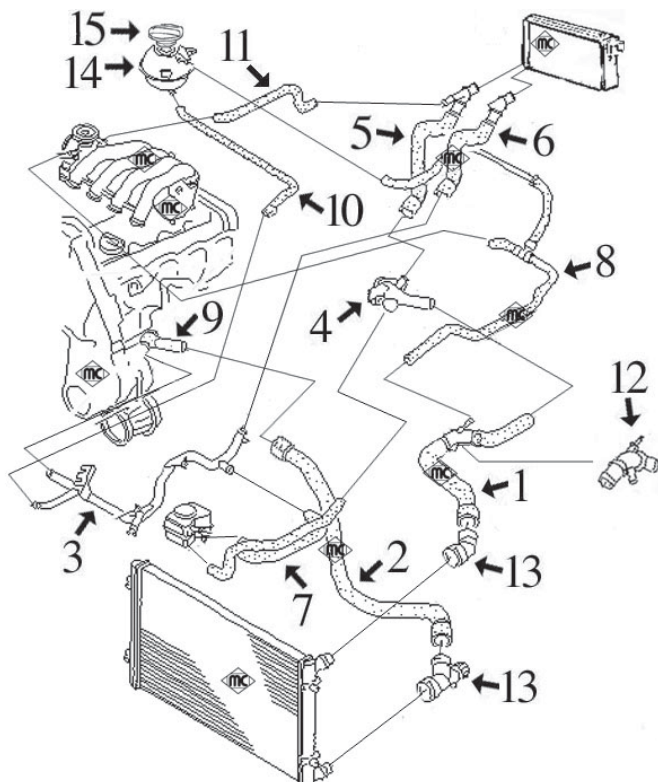













**SDi de 68CV motor AQM  
TDi de 90CV motores AGR-ALH  
TDi de 110CV motores AHF-ASV**



- 1- 9045 mgto superior radiador completo con conector rápido
  - 2- 9046 mgto inferior radiador completo con conector rápido
  - 3- 3178 tubo de agua metálico completo con junta tórica
  - 4- 3591 boquilla (plástico) en culata
  - 5- 9050 mgto de calefactor a boquilla en culata (con conector rápido)
  - 6- 9042 mgto de calefactor a tubo metálico (con conector rápido)
  - 7- 9047 mgto doble de intercambiador en filtro de aceite
  - 8- n/d mgto a caja mariposa y rebose botella
  - 9- 3590 boquilla en bloque (plástico)
  - 10- 9043 mgto de tubo metálico a botella
  - 11- n/d mgto de caja mariposa a conector en mgto calefactor
  - 12- 3604 conector mgto superior completo con accesorios
  - 13- 3721 juego de conectores superior/inferior en mgto radiador
  - 14- 3635 botella de expansión
  - 15- 3573 tapón botella de expansión
- 3722 tubo desvaporizador hasta 5/'99  
3728 tubo desvaporizador desde 5/'99



## SEAT TOLEDO-2 - LEON (1999-2005)

<p><b>iNuevo!</b></p>  <p><b>9042</b> mgto de tubo metálico a calefactor r.O.</p>	<p><b>iNuevo!</b></p>  <p><b>9043</b> mgto de botella a tubo metálico r.O.</p>	<p><b>iNuevo!</b></p>  <p><b>9044</b> mgto de caja termostato a botella r.O.</p>
<p><b>iNuevo!</b></p>  <p><b>9045</b> mgto inferior radiador r.O.</p>	<p><b>iNuevo!</b></p>  <p><b>9046</b> mgto superior radiador r.O.</p>	<p><b>iNuevo!</b></p>  <p><b>9047</b> mgto doble de intercambiador r.O.</p>
<p><b>iNuevo!</b></p>  <p><b>9048</b> mgto doble de intercambiador 1.6-1.8 r.O.</p>	<p><b>iNuevo!</b></p>  <p><b>9049</b> mgto doble de intercambiador 2.0 r.O.</p>	<p><b>iNuevo!</b></p>  <p><b>9050</b> mgto de culata a calefactor r.O.</p>
<p><b>iNuevo!</b></p>  <p><b>9051</b> mgto de culata a calefactor r.O.</p>	<p><b>iNuevo!</b></p>  <p><b>9052</b> mgto doble de calefactor r.O.</p>	<p><b>iNuevo!</b></p>  <p><b>9053</b> mgto de calefactor a boquilla en culata r.O.</p>
<p><b>iNuevo!</b></p>  <p><b>9054</b> mgto de caja de termostato a intercambiador r.O.</p>	<p><b>iNuevo!</b></p>  <p><b>9055</b> mgto desvaporizador 1.4/16v-1.6/16v r.O.</p>	<p><b>iNuevo!</b></p>  <p><b>9078</b> mgto doble superior/inferior 1.4/16v r.O.</p>
<p><b>iNuevo!</b></p>  <p><b>9079</b> mgto doble superior/inferior 1.6/16v r.O.</p>		



SEAT TOLEDO-2 - LEON (1999-2005)

<p><b>3176</b> tubo de agua metálico 1.6(8v) r.o.</p>  <p><i>nuevo!</i></p>	<p><b>3177</b> tubo de agua metálico 1.8 r.o.</p>  <p><i>nuevo!</i></p>	<p><b>3178</b> tubo de agua metálico 1.9SDi-1.9TDi r.o.</p>  <p><i>nuevo!</i></p>
<p><b>3541</b> tapa de termostato 1.4/16v-1.6/16v r.o.032121121J</p> 	<p><b>3590</b> tapa de termostato 1.9SDi-1.9TDi r.o.</p> 	<p><b>3592</b> kit completo tapa termostato y junta 1.4/ /16v-1.6/16v,r.o.032121121J+032121110B</p> 
<p><b>3597</b> tapa de termostato 1.6(8v)-1.8 r.o.</p> 	<p><b>3598</b> tapa de agua en culata (lateral) 1.6(8v)-1.8 motor AGN,r.o.</p> 	<p><b>3600</b> tapa de agua en culata (lateral) 1.8 APG r.o.</p> 
<p><b>3604</b> kit completo empalme manguito superior radiador,r.o. 1J0121087A+accesorios</p> 	<p><b>3615</b> caja de termostato 1.4/16v-1.6/16v r.o.</p> 	<p><b>3625</b> tubo de agua 1.4/16v-1.6/16v r.o.</p> 
<p><b>3635</b> botella de expansión r.o.</p> 	<p><b>3573</b> tapón botella de expansión r.o.</p> 	<p><b>3721</b> juego conectores manguitos de radiador r.o.</p>  <p><i>nuevo!</i></p>
<p><b>3722</b> tubo desvaporizador 1.9SDi-TDi desde 5/'99 r.o.</p>  <p><i>nuevo!</i></p>	<p><b>3723</b> válvula desvaporizadora 1.9SDi-TDi r.o.028129101E</p>  <p><i>nuevo!</i></p>	<p><b>3728</b> tubo desvaporizador 1.9SDi-TDi hasta 5/'99 r.o.038103493A</p>  <p><i>nuevo!</i></p>
<p><b>3745</b> tapa con termostato 1.6 100/102 CV motores APFy AVU,r.o.06A121114</p>  <p><i>nuevo!</i></p>	<p><b>2669</b> junta válvula desvaporizadora r.o.028103500</p>  <p><i>nuevo!</i></p>	



CANALIZACIONES de AIRE de ALTA PRESION INTERCOOLER-TURBO:

TOLEDO-2/LEON 1.9 Diesel TDi motores de 90 y 110CV

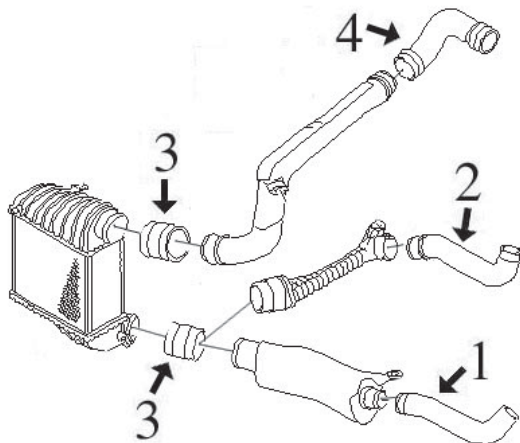

- 1- 9069 tubo flexible de empalme hasta 5/'99
- 2- 9070 tubo flexible de empalme desde 5/'99
- 3- 9064 tubo flexible de intercooler a tubo rígido
- 4- 9068 tubo flexible de tubo rígido a colector de aspiración

TOLEDO-2/LEON 1.9 Diesel TDi motor ARL de 150CV

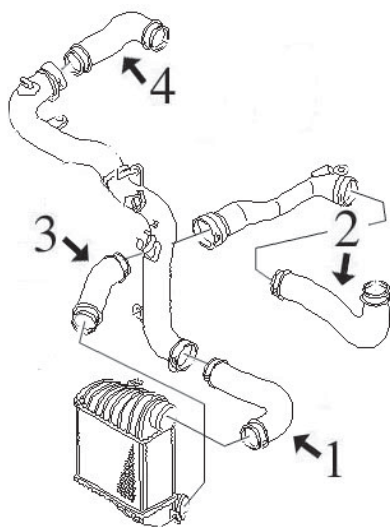

- 1- 9091 tubo flexible de intercooler a tubo rígido
- 2- n/d tubo flexible a intercooler
- 3- 9093 tubo flexible de intercooler a tubo rígido
- 4- n/d tubo flexible de tubo rígido a colector de aspiración

**iNuevo!**



**9064**  
Ø 60x70 largo 58 mm  
tubo flexible de intercooler a tubo rígido  
r.o. 1J0145834A



**iNuevo!**



**9068**  
tubo flexible de tubo rígido a colector  
r.o. 1J0145838B



**iNuevo!**



**9069**  
tubo de empalme hasta 5/'99, 90-110CV  
r.o. 1J0145828H



**iNuevo!**



**9070**  
tubo de empalme desde 5/'99 90-110CV  
r.o. 1J0145828T



**iNuevo!**



**9091**  
tubo de intercooler a tubo rígido 150CV  
r.o. 1J0145834AE



**iNuevo!**



**9093**  
tubo de intercooler a tubo rígido 150CV  
r.o. 1J0145834AA



SUSPENSION DELANTERA y SOPORTES DE MOTOR:

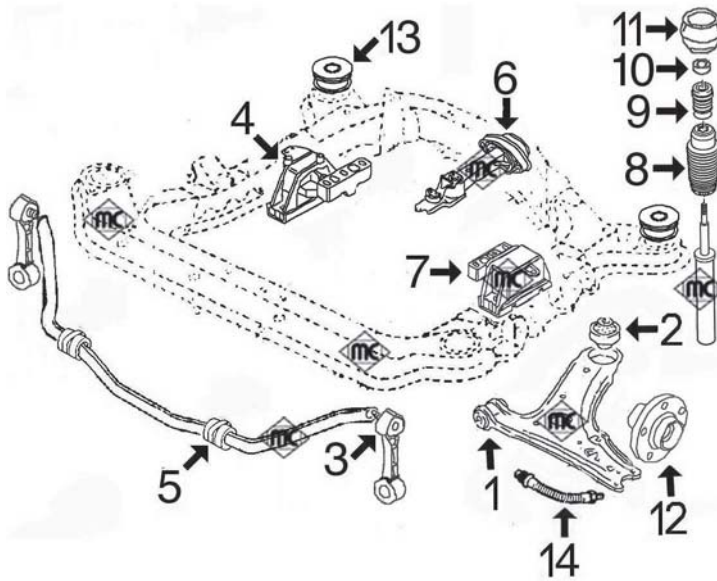

- 1- 542 silentbloc anterior trapecio delantero
- 2- 2963 silentbloc posterior trapecio delantero
- 3- 4250 bieleta puntal barra estabilizadora (plástico)
- 4249 bieleta puntal barra estabilizadora (metal)
- 4- 4368 soporte motor derecho 1.4-1.6 (105cv y 16v)-2.3V5
- 4186 soporte motor derecho 1.6 (100 y 102cv)-1.8-2.0 1.9SDi-1.9TDi
- 5- 4369 goma para barra estabilizadora de Ø 20 y 21 mm
- 4321 goma para barra estabilizadora de Ø 23 mm
- 6- 4133 soporte motor trasero
- 7- 4187 soporte motor izquierdo
- 8- 4324 capuchón amortiguador delantero
- 9- 4298 tope poliuretano amortiguador
- 10- 4128 rodamiento soporte amortiguador
- 11- 4177 soporte amortiguador completo con rodamiento
- 12- 90063 buje de rueda delantera
- 13- 4134 soporte sub-chasis trasero
- 14- 96013 latiguillo freno delantero (435 mm)

SUSPENSION TRASERA:

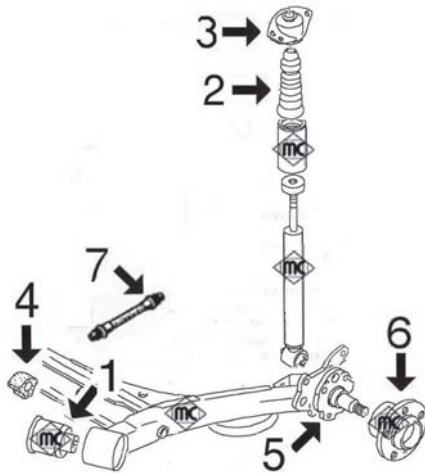

- 1- 4310 silentbloc brazo suspensión trasero
- 2- 4312 tope poliuretano amortiguador trasero
- 3- 4311 soporte amortiguador trasero
- 4- 2824 goma barra estabilizadora
- 5- n/d mangueta brazo trasero
- 6- 90521 buje rueda trasera
- 7- 96014 latiguillo freno trasero (165 mm)



**542**  
silentbloc anterior trapecio delantero  
r.o.357407182

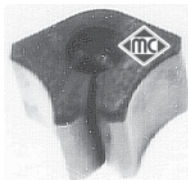

**2824**  
goma barra estabilizadora trasera  
r.o.871511423



**2963**  
silentbloc posterior trapecio delantero  
r.o.1J0407181



**4128**  
rodamiento soporte amortiguador delantero  
r.o.1J0412249



**4133**  
soporte motor trasero  
r.o.1J0199851AA



**4134**  
silentbloc sub-chasis trasero  
r.o.1J0199429

## SEAT TOLEDO-2 - LEON (1999-2005)



**4177**  
soporte amortiguador delantero completo  
con rodamiento, r.o. 1J0412331C

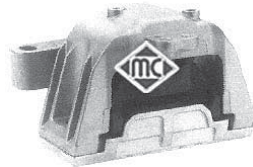

**4186**  
soporte motor derecho 1.6(100 y 102cv)-1.8-  
-2.0-1.9TDi-1.9SDi, r.o.



**4187**  
soporte motor izquierdo  
r.o.



**4249**  
bieleta puntal barra estabilizadora (metálica)  
r.o. 1J0411315G



**4250**  
bieleta puntal barra estabilizadora (plástico)  
r.o. 1J0411315C



**4298**  
tope poliuretano amortiguador delantero  
r.o.



**4310**  
silentbloc brazo trasero suspensión  
r.o. 1J0501541C



**4311**  
soporte amortiguador trasero  
r.o. 1J0512353C



**4312**  
tope poliuretano amortiguador trasero  
r.o.



**4321**  
goma para barra estabilizadora de Ø 23 mm  
r.o. 1J0411314G



**4324**  
capuchón amortiguador delantero  
r.o.



**4368**  
soporte motor derecho 1.4-1.6 (de 105cv)  
-1.6/16v y 2.3V5, r.o.



**4369**  
goma para barra estabilizadora de Ø 20 y  
21 mm, r.o. 1J0411314C



**90063**  
buje rueda delantera  
r.o. 1J0407613C



**90521**  
buje rueda trasera  
r.o. 1J0598477



**96013**  
latiguillo freno delantero (435 mm)  
r.o. 1J0611701



**96014**  
latiguillo freno trasero (165 mm)  
r.o. 6X0611775



SEAT TOLEDO-2 - LEON (1999-2005)

<p><b>¡Nuevo!</b></p> <p><b>4758</b> varilla nivel aceite 1.4/16v-1.6/16v r.o.</p>	<p><b>¡Nuevo!</b></p> <p><b>4795</b> varilla nivel aceite 1.6/8v-1.8/20v r.o.</p>	<p><b>¡Nuevo!</b></p> <p><b>4759</b> varilla nivel aceite 1.9TDi-SDi r.o.</p>
<p><b>4355</b> guía varilla nivel aceite 1.4/16v-1.6/16v r.o.</p>	<p><b>3568</b> guía varilla nivel aceite 1.6/8v r.o.</p>	<p><b>3553</b> guía varilla nivel aceite 1.8/20v r.o.</p>
<p><b>3571</b> guía varilla nivel aceite 1.9SDi-1.9TDi r.o.</p>	<p><b>3621</b> tapón llenado aceite motor (plástico, reemplaza al metálico), r.o.</p>	<p><b>4365</b> juego tornillos sujeción tapa motor r.o.</p>
<p><b>¡Nuevo!</b></p> <p><b>4421</b> polea cigüeñal 1.9TDi-SDi todos hasta '03 r.o.038105243</p>	<p><b>¡Nuevo!</b></p> <p><b>4480</b> polea cigüeñal 1.9TDi(100-130CV)desde '03- r.o.03G105243</p>	<p><b>¡Nuevo!</b></p> <p><b>4494</b> polea cigüeñal 1.9SDi desde '03- r.o.038105243L</p>
<p><b>4405</b> polea cigüeñal 1.8 gasolina r.o.06A105243F</p>	<p><b>¡Nuevo!</b></p> <p><b>3711</b> tubo de aire a caudalímetro 1.6-1.8 r.o.</p>	<p><b>¡Nuevo!</b></p> <p><b>3718</b> tubo de aire a caudalímetro 1.9Diesel r.o.</p>
<p><b>¡Nuevo!</b></p> <p><b>4749</b> casquillo guía embrague 1.8-1.9TDi-2.3 r.o.02A141180A</p>	<p><b>¡Nuevo!</b></p> <p><b>4772</b> leva embrague 1.4/16v-1.6/16v-1.6/8v-1.9SDi r.o.02K141709A</p>	<p><b>¡Nuevo!</b></p> <p><b>3691</b> articulación cambio 1.9TDi hasta 5/'99 r.o.</p>
<p><b>4326</b> bieleta reenvío cambio velocidades (excepto reenvío por cable), r.o.</p>	<p><b>4327</b> bieleta reenvío cambio velocidades (excepto reenvío por cable), r.o.</p>	<p><b>4328</b> bieleta reenvío cambio velocidades (excepto reenvío por cable), r.o.</p>

SEAT TOLEDO-2 - LEON (1999-2005)

**3720**  
tapa correa distribución 1.6(100CV)  
r.o.06A109108S



**5044**  
tensor correa alternador 1.9TDi  
r.o.038903315D/P



**4770**  
tensor correa alternador 1.4-1.6 sin a/c  
r.o.030145299F



**4767**  
rodillo tensor correa alternador  
r.o.038145276

Ø 65 mm



**4922**  
rodillo en tensor correa alternador 1.9Diesel  
r.o.

Ø 17x70 mm



**4968**  
rodillo en tensor correa alternador  
r.o.

Ø 17x76 mm



**5009**  
tensor correa alternador 1.4-1.6 con a/c  
r.o.032145299A



**5010**  
tensor correa alternador 1.6(100cv)-1.8-2.0  
r.o.06A903315E



**4944**  
tensor correa alternador 1.9TDi  
r.o.038903315C



**5039**  
tensor correa alternador 1.9SDi  
r.o.038903315K



**4997**  
polea alternador de rueda libre  
r.o.022903119A

Ø 61/55 mm, H=41 mm



**4999**  
polea alternador de rueda libre  
r.o.038903119AA

Ø 61/55 mm, H=41 mm



**4296**  
kit reparación distribuidor Magneti-Marelli  
1.4-1.6 (casquillo sinterizado del eje rotor)



**1921**  
kit fuelle transm. l/rda 1.4-1.6(105cv)-1.6/16v  
y 1.9SDi (Ø 26-78 mm), r.o. 1J0498203



**1297**  
kit fuelle transm. l/rda. 1.6(100-102cv)-1.8-  
2.0 y TDi de 90-100-110cv, (Ø 25-86 mm)



**1102**  
kit fuelle transmisión l/rueda TDi de 115-130-  
y 150cv (Ø 29-98 mm), r.o. 1J0498203A



**1106**  
kit fuelle transm. l/cambio 1.4-1.6(100-105cv)  
1.6/16v y 1.9SDi (Ø 27-94 mm)



**1560**  
kit fuelle transm. izqda. l/cambio 1.8-2.0-1.6  
(100-102cv) y 1.9TDi (Ø 21-100 mm)



**1637**  
kit fuelle transm. dcha. l/cambio 1.8-2.0-1.6  
(100-102cv) y 1.9TDi (Ø 21-100 mm)



**1192**  
kit fuelle transmisión l/cambio 1.9TDi-1.8-  
2.0 (Ø 27-100 mm), r.o. 6Q0498201A



**1479**  
fuelle cremallera dirección  
r.o. 1J0422831B



SEAT TOLEDO-2 - LEON (1999-2005)



**4121**  
soporte catalizador  
r.o.



**4364**  
soporte catalizador  
r.o.



**4122**  
soporte presilenciador 1.4-1.6  
r.o.



**2426**  
soporte presilenciador 1.9TDi-1.9SDi  
r.o. 1H0253147B



**4123**  
soporte presilenciador 1.6-1.8-2.0  
r.o.



**4098**  
soporte silenciador trasero  
r.o.



**3575**  
juego grapas plástico alzacristales LEON  
r.o. (no hay despiece)



**4248**  
tuerca rueda M14x1,5x27  
r.o. 8D0601139D



**2916**  
tapón cárter de aceite  
r.o.

**¡Nuevo!**



**3738**  
interruptor luz de freno (4 polos)  
r.o. 1J0945511C/D

**¡Nuevo!**



**3739**  
interruptor luz de freno (2 polos)  
r.o. 191945515-191945915A/B

**¡Nuevo!**



**3689**  
válvula filtro gasoil  
r.o. 1J0127247A

**¡Nuevo!**



**3708**  
tapón llenado combustible (sin llave)  
r.o.





SUSPENSION DELANTERA y SOPORTES DE MOTOR:

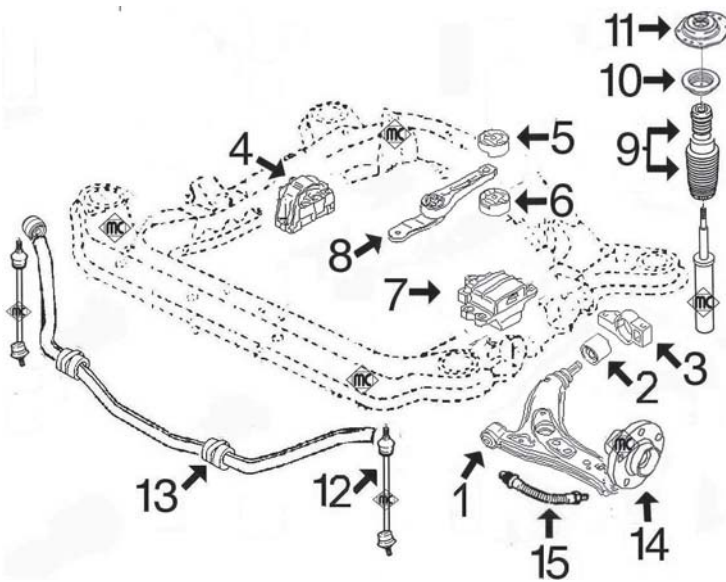

- 1- 4864 silentbloc anterior trapecio delantero
- 2- 4691 silentbloc posterior trapecio delantero
- 3- 4862 silentbloc posterior trapecio delantero izquierdo completo con cuerpo de aluminio
- 4863 silentbloc posterior trapecio delantero derecho completo con cuerpo de aluminio
- 4- 4865 soporte motor derecho 1.4-1.6-1.9TDi-2.0TDi
- 4866 soporte motor derecho 1.4FSi-1.6FSi-2.0GTi
- 5- 4859 silentbloc superior soporte trasero motor
- 6- 4860 silentbloc inferior soporte trasero motor
- 7- 4867 soporte motor izquierdo 1.4/16v-1.6-1.6/16v-1.9TDi-2.0FSi
- 4868 soporte motor izquierdo 1.9TDi (cambio manual automatizado)-2.0TDi
- 8- 4872 bieleta soporte motor trasero 1.4-1.6 gasolina
- 4987 bieleta soporte motor trasero 1.9TDi-2.0TDi-2.0 gasolina y Automáticos todos
- 9- 4765 juego capuchón y tope poliuretano amortiguador
- 10- 4789 rodamiento soporte amortiguador
- 11- 4871 soporte amortiguador completo con rodamiento
- 12- 4874 bieleta puntal barra estabilizadora
- 13- 4861 goma barra estabilizadora
- 14- n/d buje rueda delantera
- 15- n/d latiguillo freno delantero



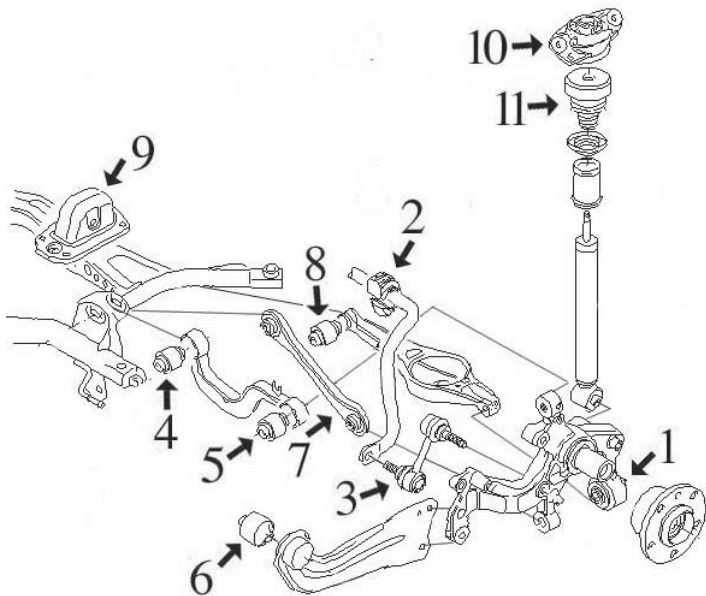







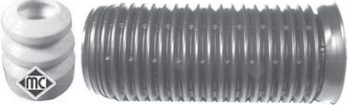







SUSPENSION TRASERA:



- 1- n/d silentbloc mangueta a brazo inferior
- 2- 4861 goma barra estabilizadora
- 3- 4967 bieleta puntal barra estabilizadora
- 4- n/d silentbloc interior brazo transversal
- 5- n/d silentbloc exterior brazo transversal
- 6- n/d silentbloc en brazo oscilante
- 7- n/d barra de acoplamiento
- 8- n/d silentbloc interior brazo inferior
- 9- n/d soporte elástico
- 10- 4873 soporte amortiguador trasero
- 11- n/d tope poliuretano



SEAT TOLEDO-3 (2004-) LEON-2 (2004-) ALTEA

<p><b>¡Nuevo!</b></p>  <p><b>4691</b> silentbloc posterior trapecio delantero r.o. 1K0407183A/B</p>	<p><b>¡Nuevo!</b></p>  <p><b>4765</b> juego tope poliuretano y capuchón amortiguador delantero, r.o. 6N0412375A</p>	<p><b>¡Nuevo!</b></p>  <p><b>4789</b> rodamiento soporte amortiguador delant. r.o. 6N0412249C</p>
<p><b>¡Nuevo!</b></p>  <p><b>4859</b> soporte superior tirante trasero de motor r.o. 1K0199867</p>	<p><b>¡Nuevo!</b></p>  <p><b>4860</b> soporte inferior tirante trasero de motor r.o. 1K0199868</p>	<p><b>¡Nuevo!</b></p>  <p><b>4861</b> goma barra estabilizadora delantera y tras. r.o. 1K0511327AP</p>
<p><b>¡Nuevo!</b></p>  <p><b>4862</b> silentbloc posterior trapecio del. <b>izquierdo</b> completo, r.o. 1K0199231G</p>	<p><b>¡Nuevo!</b></p>  <p><b>4863</b> silentbloc posterior trapecio del. <b>derecho</b> completo, r.o. 1K0199232G</p>	<p><b>¡Nuevo!</b></p>  <p><b>4864</b> silentbloc anterior trapecio delantero r.o. 1K0407182</p>
<p><b>¡Nuevo!</b></p>  <p><b>4865</b> soporte motor derecho 1.4-1.6-1.9D-2.0D r.o. 1K0199262L/M</p>	<p><b>¡Nuevo!</b></p>  <p><b>4866</b> soporte motor derecho 1.4FSi-1.6FSi-2.0GTi r.o. 1K0199262AA/AJ/T</p>	<p><b>¡Nuevo!</b></p>  <p><b>4867</b> soporte motor izquierdo 1.4-1.6-1.9D-2.0D r.o. 1K0199555L/M</p>
<p><b>¡Nuevo!</b></p>  <p><b>4868</b> soporte motor izquierdo 2.0TDi y 1.9TDi cam- bio semiautomático, r.o. 1K0199555Q/T</p>	<p><b>¡Nuevo!</b></p>  <p><b>4871</b> soporte amortiguador delantero completo con rodamiento, r.o. 1K0412331B/C</p>	<p><b>¡Nuevo!</b></p>  <p><b>4872</b> soporte-tirante motor trasero 1.4-1.6 r.o. 1K0199851K</p>
<p><b>¡Nuevo!</b></p>  <p><b>4873</b> soporte amortiguador trasero r.o. 1K0512353G/H/J</p>	<p><b>¡Nuevo!</b></p>  <p><b>4874</b> bieleta puntal barra estabilizadora delantera r.o. 1K0411315D/J</p>	<p><b>¡Nuevo!</b></p>  <p><b>4967</b> bieleta puntal barra estabilizadora trasera r.o. 1K0505465K</p>
<p><b>¡Nuevo!</b></p>  <p><b>4987</b> soporte-tirante motor trasero 1.9TDi-2.0TDi- 2.0gasolina y Automáticos, r.o. 1K0199851L</p>		

SEAT TOLEDO-3 (2004-) LEON-2 (2004-) ALTEA

<p><b>4480</b> polea cigueñal 1.9TDi-2.0TDi r.o.03G105243</p> 	<p><b>4405</b> polea cigueñal 2.0FSi r.o.06A105243E</p> 	<p><b>4365</b> juego sujeción tapa motor TDi r.o.</p> 
<p><b>3621</b> tapón llenado aceite motor r.o.06A103485</p> 	<p><b>4793</b> varilla nivel aceite 1.4/16v-1.6/16v r.o.030115611R</p> 	<p><b>4759</b> varilla nivel aceite 1.9TDi-2.0TDi r.o.038115611B</p> 
<p><b>4355</b> guía varilla nivel aceite 1.4/16v-1.6/16v r.o.030115636A</p> 	<p><b>3597</b> pipa de agua 1.6 r.o.06A121121C</p> 	<p><b>3721</b> juego conectores manguitos radiador r.o.6Q0122291F+1J0122291</p> 
<p><b>3677</b> tapón botella de expansión r.o.03B121321</p> 	<p><b>4749</b> casquillo guía embrague con retén r.o.02A141180A</p> 	<p><b>4770</b> tensor correa alternador 1.4 con aire ac. r.o.030145299F</p> 
<p><b>1479</b> fuelle cremallera dirección r.o.1J0422831B</p> 	<p><b>1921</b> kit fuelle transmisión lado rueda bocas de Ø 26-78 mm, r.o. 1J0498203</p> 	<p><b>1297</b> kit fuelle transmisión lado rueda bocas de Ø 25-86 mm, r.o. 1H0407285A</p> 
<p><b>1102</b> kit fuelle transmisión lado /rueda bocas de Ø 29-98 mm, r.o. 1K0498203A</p> 	<p><b>1106</b> kit fuelle transmisión lado cambio bocas de Ø 27-94 mm, r.o. 1K0498201B</p> 	<p><b>1192</b> kit fuelle transmisión lado cambio bocas de Ø 27-100 mm, r.o. 1K0498201</p> 
<p><b>2308</b> kit fuelle transmisión lado cambio bocas de Ø 27-100 mm, r.o. 1K0498201A</p> 	<p><b>3708</b> tapón llenado combustible (sin llave) r.o.1J0201553C</p> 	

SEAT TOLEDO-3 (2004-) LEON-2 (2004-) ALTEA

<p><b>¡Nuevo!</b></p>  <p><b>4767</b> Ø 65 mm rodillo tensor correa alternador r.o.038145276</p>	<p><b>¡Nuevo!</b></p>  <p><b>4769</b> Ø 75,5 mm rodillo tensor correa alternador 5 canales r.o.038145278</p>	<p><b>¡Nuevo!</b></p>  <p><b>4922</b> Ø 17x70 mm rodillo en tensor correa alternador r.o.</p>
<p><b>¡Nuevo!</b></p>  <p><b>4968</b> Ø 17x76 mm rodillo en tensor correa alternador r.o.</p>	<p><b>¡Nuevo!</b></p>  <p><b>3738</b> interruptor luz de freno (4 polos) r.o.1J0945511D/C</p>	 <p><b>2916</b> tapón cárter de aceite con junta r.o.N90813201</p>
<p><b>¡Nuevo!</b></p>  <p><b>4770</b> tensor correa alternador 1.4 r.o.030145299F</p>	<p><b>¡Nuevo!</b></p>  <p><b>5010</b> tensor correa alternador 1.6-1.8-2.0 r.o.06A903315E</p>	<p><b>¡Nuevo!</b></p>  <p><b>4997</b> Ø 61/55 mm, H=41 mm polea de alternador de rueda libre r.o.022903119A</p>
<p><b>¡Nuevo!</b></p>  <p><b>4869</b> soporte silenciador trasero r.o.1K0253144AH</p>	<p><b>¡Nuevo!</b></p>  <p><b>4870</b> soporte escape r.o.1K0253144AP</p>	 <p><b>2766</b> soporte escape r.o.8D0253147E</p>
 <p><b>4248</b> tuerca rueda M14x1,5x27 r.o.8D0601139D</p>		

**SUSPENSION DELANTERA y SOPORTES DE MOTOR:**

1.2/3 cil.-1.4/3 cil.-1.4/16v-1.8/20v-2.0  
1.9SDi - 1.9TDi

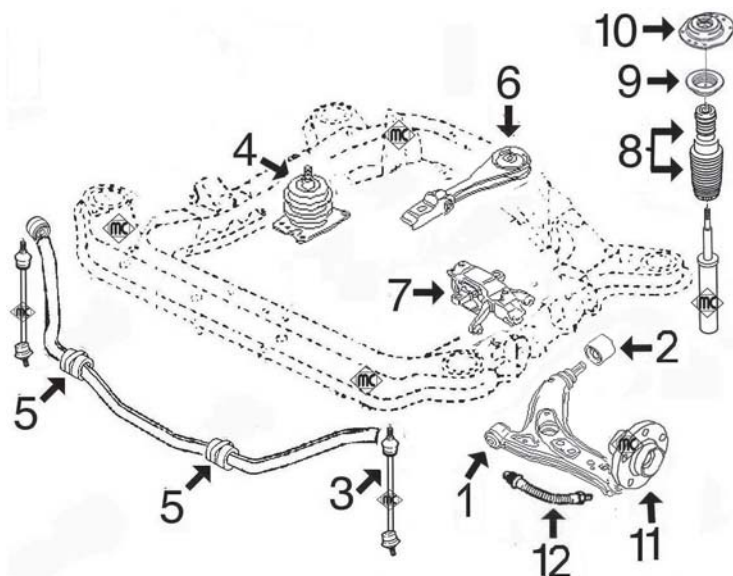

- 1- 4671 silentbloc anterior trapezio delantero
- 2- 4670 silentbloc posterior trapezio delantero
- 3- 4792 bieleta puntal barra estabilizadora completa
- 4- 4786 soporte motor derecho
- 5- 4918 goma barra estabilizadora
- 6- 4804 soporte motor trasero 1.4TDi-1.8/20v
- 4787 soporte motor trasero 1.2-1.4/3cil.-1.4/16v
- 4797 soporte motor trasero 1.9SDi-2.0
- 4804 soporte motor trasero 1.9TDi 5 velocidades
- 4805 soporte motor trasero 1.9TDi 6 velocidades
- 7- 4785 soporte motor izquierdo
- 8- 4765 juego fuelle amortiguador delantero completo con tope de poliuretano
- 9- 4789 rodamiento soporte amortiguador
- 10- 4788 soporte amortiguador delantero completo con rodamiento
- 11- 90100 buje rueda delantera
- 12- 96200 latiguillo freno delantero



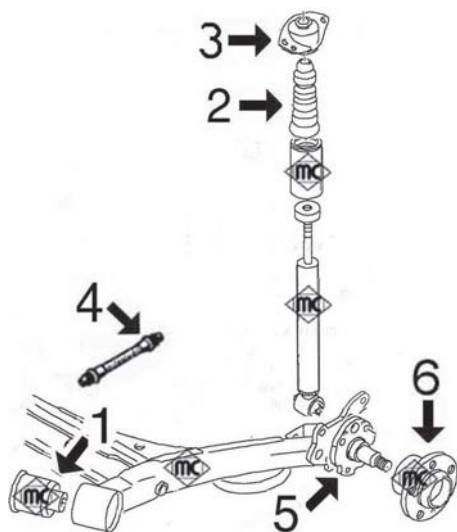











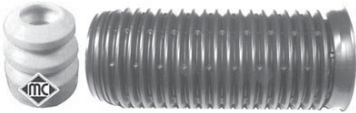
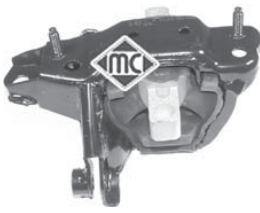



**SUSPENSION TRASERA:**















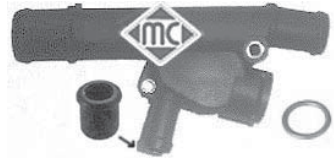

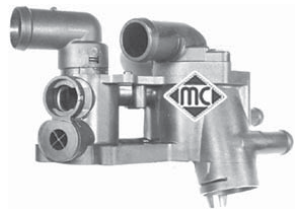
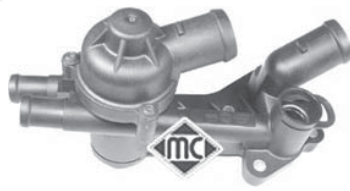





- 1- 4310 silentbloc brazo trasero suspensión
- 2- 4920 tope poliuretano amortiguador trasero
- 3- 4311 soporte amortiguador trasero
- 4- 96014 latiguillo freno trasero
- 5- n/d mangueta rueda trasera
- 6- 90503 buje rueda trasera con rodamiento



## SKODA FABIA (2000- )

 <p><b>4310</b> silentbloc brazo suspensión trasera r.o. 6Q0407151D</p>	 <p><b>4311</b> soporte amortiguador trasero r.o. 6Q0407183A</p>	 <p><b>4670</b> silentbloc posterior trapecio delantero r.o. 6Q0407183A</p>
 <p><b>4671</b> silentbloc anterior trapecio delantero r.o. 6Q0407151D</p>	 <p><b>4765</b> juego fuelle amortiguador delantero y tope poliuretano, r.o. 6N0412303A-6N0413175A</p>	 <p><b>4785</b> soporte motor izquierdo r.o. 6Q0199555AC/AD/AE/K</p>
 <p><b>4786</b> soporte motor derecho r.o. 6Q0199167CB/BM/CC/BC/CA/CD</p>	 <p><b>4787</b> soporte motor trasero 1.2-1.4-1.4/16v r.o. 6Q0199851AB/AE</p>	 <p><b>4788</b> soporte amortiguador delantero completo con rodamiento r.o. 6N0412331E</p>
 <p><b>4789</b> rodamiento soporte amortiguador delantero r.o. 6N0412249C</p>	 <p><b>4792</b> bieteleta puntal barra estabilizadora r.o. 6Q0411315F</p>	 <p><b>4797</b> soporte motor trasero 1.9SDi-2.0 r.o. 6Q0199851T/M/D</p>
 <p><b>4804</b> soporte motor trasero 1.9TDi 5 velocidades r.o. 6Q0199851AC/B/E/J</p>	 <p><b>4805</b> soporte motor trasero 1.9TDi 6 velocidades r.o. 6Q0199851N</p>	 <p><b>4918</b> goma barra estabilizadora delantera r.o. 6Q0512131B</p>
 <p><b>4920</b> tope poliuretano suspensión trasera r.o. 6Q0512131B</p>	 <p><b>90100</b> bujе rueda delantera con rodamiento r.o. 6Q0407621AJ</p>	 <p><b>90503</b> bujе rueda trasera con rodamiento r.o. 6Q0598611</p>
 <p><b>96200</b> latiguillo freno delantero (555 mm) r.o. 6Q0611701C</p>	 <p><b>96014</b> latiguillo freno trasero (165 mm) r.o. 6X0611775</p>	

## SKODA FABIA (2000- )

<p><b>¡Nuevo!</b></p>  <p><b>3675</b> botella de expansión r.o. 6Q0121407A</p>	<p><b>¡Nuevo!</b></p>  <p><b>3677</b> tapón botella de expansión r.o. 3B0121321</p>	 <p><b>3591</b> brida de agua en culata 1.9SDi r.o. 038121132C</p>
 <p><b>3625</b> tubo de agua 1.4/16v r.o. 6Q0121407A</p>	<p><b>¡Nuevo!</b></p>  <p><b>3693</b> caja de termostato completa 1.4-1.4/16v r.o. 032121111AP</p>	<p><b>¡Nuevo!</b></p>  <p><b>3726</b> caja termostato completa 1.2 (3 cilindros) r.o. 03C121111B</p>
<p><b>¡Nuevo!</b></p>  <p><b>3727</b> tubo desvaporizador 1.9Diesel r.o. 038103493H</p>	 <p><b>3621</b> tapón llenado aceite motor r.o. 06B103485B/H</p>	<p><b>¡Nuevo!</b></p>  <p><b>3688</b> guía varilla nivel aceite 1.2 r.o. 036115636</p>
 <p><b>4355</b> guía varilla nivel aceite 1.4/16v r.o. 030115636A</p>	 <p><b>3568</b> guía varilla nivel aceite 1.8 gasolina r.o. 06A103663B</p>	 <p><b>3571</b> guía varilla nivel aceite 1.9D r.o. 038103663</p>
<p><b>¡Nuevo!</b></p>  <p><b>3725</b> guía varilla nivel aceite 1.4TDi r.o. 06A103663A</p>	 <p><b>3553</b> guía varilla nivel aceite 2.0 gasolina r.o. 06A103663C</p>	<p><b>¡Nuevo!</b></p>  <p><b>4793</b> varilla nivel aceite 1.4/16v r.o.</p>
<p><b>¡Nuevo!</b></p>  <p><b>4794</b> varilla nivel aceite 1.4TDi r.o.</p>	<p><b>¡Nuevo!</b></p>  <p><b>4759</b> varilla nivel aceite 1.9Diesel r.o.</p>	<p><b>¡Nuevo!</b></p>  <p><b>4795</b> varilla nivel aceite 1.8 gasolina r.o.</p>
<p><b>¡Nuevo!</b></p>  <p><b>4492</b> polea cigüeñal 1.4 TDi r.o. 045105243-045105243B</p>	<p><b>¡Nuevo!</b></p>  <p><b>4494</b> polea cigüeñal 1.9SDi r.o. 038105243L-038105243M</p>	<p><b>¡Nuevo!</b></p>  <p><b>4480</b> polea cigüeñal 1.9TDi r.o. 03G105243-038105243L</p>

## SKODA FABIA (2000- )

 <p><b>4405</b> polea cigueñal 1.8-2.0 gasolina r.o. 06A105243E/F</p>	 <p><b>4770</b> tensor correa alternador 1.4/16v r.o. 030145299F</p>	 <p><b>5010</b> tensor correa alternador 2.0 r.o. 06A903315E</p>
 <p><b>4997</b>      Ø 61/55 mm, H=41 mm polea de alternador de rueda libre r.o. 022903119A</p>	 <p><b>4749</b> casquillo guía embrague r.o. 02A141180A</p>	 <p><b>4296</b> kit reparación distribuidor Magneti-Marelli (casquillo sinterizado del eje rotor)</p>
 <p><b>3689</b> válvula filtro gasoil r.o. 1J0127247A</p>	 <p><b>864</b> cubrepedal freno y embrague r.o. 321721173</p>	 <p><b>792</b> tornillo rueda M-12x150x23,5 r.o. 3A0601139</p>
 <p><b>2426</b> soporte anterior tubo de escape r.o. 6X0253147</p>	 <p><b>4762</b> soporte posterior tubo de escape r.o. 6Q0253144G</p>	 <p><b>4917</b> soporte posterior tubo de escape r.o. 6Q0253144B/D</p>
 <p><b>674</b> tapón cárter de aceite 1.2 - 1.9D - 1.8 - 2.0 r.o. N90288901</p>	 <p><b>2916</b> tapón cárter de aceite 1.4/16v - 1.4TDi r.o. N90813201</p>	 <p><b>3738</b> interruptor luz de freno (4 polos) r.o. 1J0945511D/C</p>
 <p><b>4365</b> juego tornillos fijación tapa motor r.o. 028103638G+028103665+028103937</p>		



# SKODA OCTAVIA-1 (1997-2004)

## CANALIZACIONES DE AGUA:

OCTAVIA

1.4/16v  
1.6/16v

motores AHW-AXP-BCA  
motores AUS-AZD-BCB

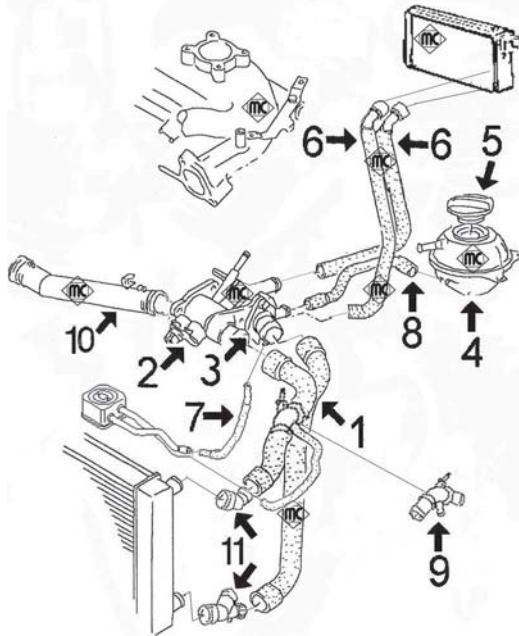

- 1- 9078 mgto doble superior/inferior 1.4/16v completo con conectores rápidos
- 9079 mgto doble superior/inferior 1.6/16v completo con conectores rápidos
- 2- 3615 caja de termostato completa
- 3- 3592 kit de termostato completo con tapa y junta
- 3541 tapa de termostato
- 4- 3635 botella de expansión
- 5- 3573 tapón botella de expansión
- 6- 9052 mgto doble de entrada/salida calefactor completo con conectores rápidos
- 7- 9054 mgto de intercambiador a caja termostato (sólo 1.6)
- 8- 9044 mgto de caja termostato a botella
- 9- 3604 conector mgto superior completo con accesorios
- 10- 3625 tubo de agua (plástico) de bomba a caja termostato
- 11- 3721 juego de conectores superior/inferior en mgto radiador
  
- 9055 mgto desvaporizador

OCTAVIA

1.6/8v

motores AEH-AKL-AVU

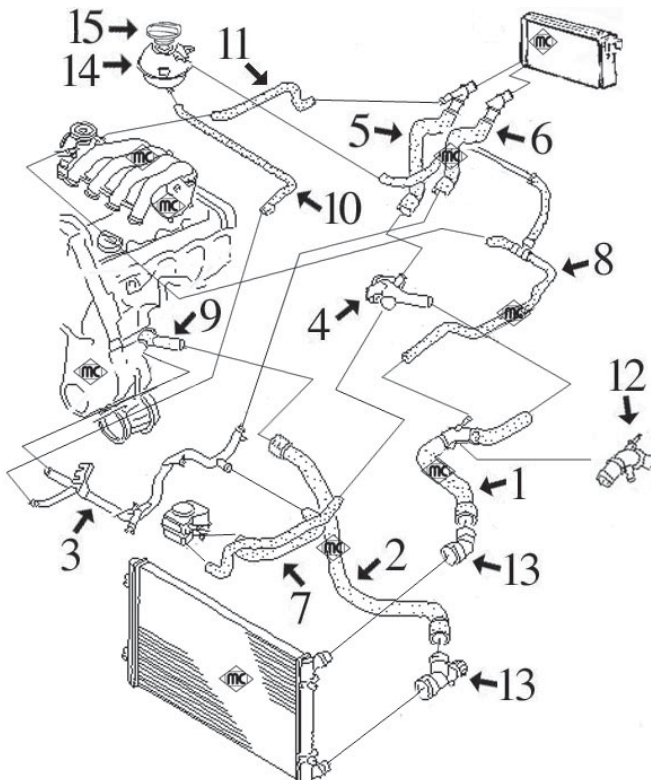

- 1- 9045 mgto superior radiador completo con conector rápido
- 2- 9046 mgto inferior radiador completo con conector rápido
- 3- 3176 tubo de agua metálico completo con junta tórica
- 4- 3598 boquilla (plástico) en culata
- 5- 9051 mgto de calefactor a boquilla en culata (con conector rápido)
- 6- 9042 mgto de calefactor a tubo metálico (con conector rápido)
- 7- 9048 mgto doble de intercambiador en filtro de aceite
- 8- n/d mgto a caja mariposa y reboso botella
- 9- 3597 boquilla en bloque (plástico)
- 10- 9043 mgto de tubo metálico a botella
- 11- n/d mgto de caja mariposa a conector en mgto calefactor
- 12- 3604 conector mgto superior completo con accesorios
- 13- 3721 juego de conectores superior/inferior en mgto radiador
- 14- 3635 botella de expansión
- 15- 3573 tapón botella de expansión



# SKODA OCTAVIA-1 (1997-2004)

OCTAVIA 1.8  
2.0

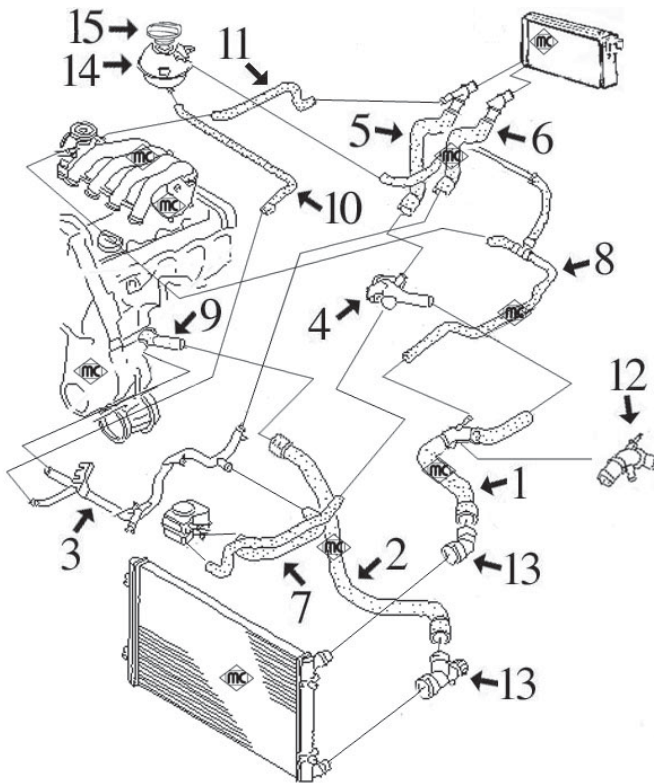

- 1- 9045 mgto superior radiador completo con conector rápido
- 2- 9046 mgto inferior radiador completo con conector rápido
- 3- 3177 tubo de agua metálico completo con junta tórica, motor 1.8  
3176 tubo de agua metálico completo con junta tórica, motor 2.0
- 4- 3598 boquilla (plástico) en culata motor AGN
- 5- 9051 mgto de calefactor a boquilla en culata (con conector rápido)
- 6- 9042 mgto de calefactor a tubo metálico (con conector rápido)
- 7- 9048 mgto doble de intercambiador en filtro de aceite, motor 1.8  
9049 mgto doble de intercambiador en filtro de aceite, motor 2.0
- 8- n/d mgto a caja mariposa y rebose botella
- 9- 3597 boquilla en bloque (plástico)
- 10- 9043 mgto de tubo metálico a botella
- 11- n/d mgto de caja mariposa a conector en mgto calefactor
- 12- 3604 conector mgto superior completo con accesorios
- 13- 3721 juego de conectores superior/inferior en mgto radiador
- 14- 3635 botella de expansión
- 15- 3573 tapón botella de expansión





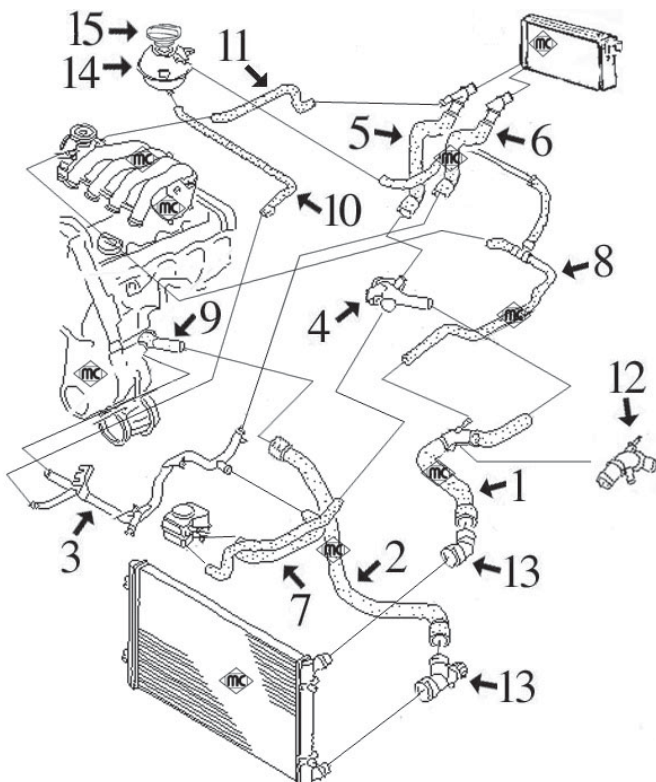











OCTAVIA 1.9 Diesel

SDi de 68CV motor AQM  
TDi de 90CV motores AGR-ALH  
TDi de 110CV motores AHF-ASV



- 1- 9045 mgto superior radiador completo con conector rápido
- 2- 9046 mgto inferior radiador completo con conector rápido
- 3- 3178 tubo de agua metálico completo con junta tórica
- 4- 3591 boquilla (plástico) en culata
- 5- 9050 mgto de calefactor a boquilla en culata (con conector rápido)
- 6- 9042 mgto de calefactor a tubo metálico (con conector rápido)
- 7- 9047 mgto doble de intercambiador en filtro de aceite
- 8- n/d mgto a caja mariposa y rebose botella
- 9- 3590 boquilla en bloque (plástico)
- 10- 9043 mgto de tubo metálico a botella
- 11- n/d mgto de caja mariposa a conector en mgto calefactor
- 12- 3604 conector mgto superior completo con accesorios
- 13- 3721 juego de conectores superior/inferior en mgto radiador
- 14- 3635 botella de expansión
- 15- 3573 tapón botella de expansión

## SKODA OCTAVIA-1 (1997-2004)

<p><b>¡Nuevo!</b></p>  <p><b>9042</b> mgto de tubo metálico a calefactor r.O.</p>	<p><b>¡Nuevo!</b></p>  <p><b>9043</b> mgto de botella a tubo metálico r.O.</p>	<p><b>¡Nuevo!</b></p>  <p><b>9044</b> mgto de caja termostato a botella r.O.</p>
<p><b>¡Nuevo!</b></p>  <p><b>9045</b> mgto inferior radiador r.O.</p>	<p><b>¡Nuevo!</b></p>  <p><b>9046</b> mgto superior radiador r.O.</p>	<p><b>¡Nuevo!</b></p>  <p><b>9047</b> mgto doble de intercambiador r.O.</p>
<p><b>¡Nuevo!</b></p>  <p><b>9048</b> mgto doble de intercambiador 1.6-1.8 r.O.</p>	<p><b>¡Nuevo!</b></p>  <p><b>9049</b> mgto doble de intercambiador 2.0 r.O.</p>	<p><b>¡Nuevo!</b></p>  <p><b>9050</b> mgto de culata a calefactor r.O.</p>
<p><b>¡Nuevo!</b></p>  <p><b>9051</b> mgto de culata a calefactor r.O.</p>	<p><b>¡Nuevo!</b></p>  <p><b>9052</b> mgto doble de calefactor r.O.</p>	<p><b>¡Nuevo!</b></p>  <p><b>9053</b> mgto de calefactor a boquilla en culata r.O.</p>
<p><b>¡Nuevo!</b></p>  <p><b>9054</b> mgto de caja de termostato a intercambiador r.O.</p>	<p><b>¡Nuevo!</b></p>  <p><b>9055</b> mgto desvaporizador 1.4/16v-1.6/16v r.O.</p>	<p><b>¡Nuevo!</b></p>  <p><b>9078</b> mgto doble superior/inferior 1.4/16v r.O.</p>
<p><b>¡Nuevo!</b></p>  <p><b>9079</b> mgto doble superior/inferior 1.6/16v r.O.</p>		

## SKODA OCTAVIA-1 (1997-2004)

<p><b>¡Nuevo!</b></p>  <p><b>3176</b> tubo de agua metálico 1.6(8v) y 2.0 r.o. 032121121J</p>	<p><b>¡Nuevo!</b></p>  <p><b>3177</b> tubo de agua metálico 1.8 r.o. 032121121J</p>	<p><b>¡Nuevo!</b></p>  <p><b>3178</b> tubo de agua metálico 1.9SDi-1.9TDi r.o. 032121121J+032121110B</p>
 <p><b>3541</b> tapa de termostato 1.4/16v-1.6/16v r.o.032121121J</p>	 <p><b>3590</b> tapa de termostato 1.9SDi-1.9TDi r.o.038121121</p>	 <p><b>3592</b> kit completo tapa termostato y junta 1.4/ /16v-1.6/16v,r.o.032121121J+032121110B</p>
 <p><b>3597</b> tapa de termostato 1.6(8v)-1.8-2.0 r.o.06A121121C-038121121D</p>	 <p><b>3598</b> tapa de agua en culata (lateral) 1.6(8v)-1.8 y 2.0,r.o.06A121132</p>	
 <p><b>3604</b> kit completo empalme manguito superior radiador,r.o. 1J0121087A+accesorios</p>	 <p><b>3615</b> caja de termostato 1.4/16v-1.6/16v r.o. 032121111N</p>	 <p><b>3625</b> tubo de agua 1.4/16v-1.6/16v r.o. 032121065D</p>
 <p><b>3635</b> botella de expansión r.o. 1J0121403B</p>	 <p><b>3573</b> tapón botella de expansión r.o. 1J0121321B</p>	<p><b>¡Nuevo!</b></p>  <p><b>3721</b> juego conectores manguitos de radiador r.o. 032121065D</p>
<p><b>¡Nuevo!</b></p>  <p><b>3722</b> tubo desvaporizador 1.9SDi-TDi desde 5/99 r.o.038103493P</p> 	<p><b>¡Nuevo!</b></p>  <p><b>3723</b> válvula desvaporizadora 1.9SDi-TDi r.o.028129101E</p>	<p><b>¡Nuevo!</b></p>  <p><b>3728</b> tubo desvaporizador 1.9SDi-TDi hasta 5/99 r.o.038103493A</p> 
 <p><b>2669</b> junta válvula desvaporizadora r.o.028103500</p> 		



CANALIZACIONES de AIRE de ALTA PRESION INTERCOOLER-TURBO:

OCTAVIA 1.9 Diesel TDi motores de 90 y 110CV

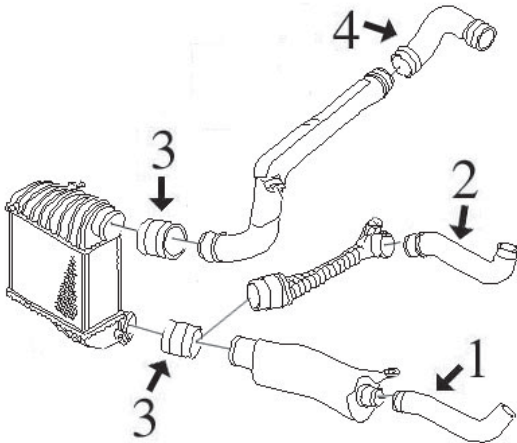

- 1- 9069 tubo flexible de empalme hasta 5/'99
- 2- 9070 tubo flexible de empalme desde 5/'99
- 3- 9064 tubo flexible de intercooler a tubo rígido
- 4- 9068 tubo flexible de tubo rígido a colector de aspiración

OCTAVIA 1.9 Diesel TDi motores de 130 y 150CV

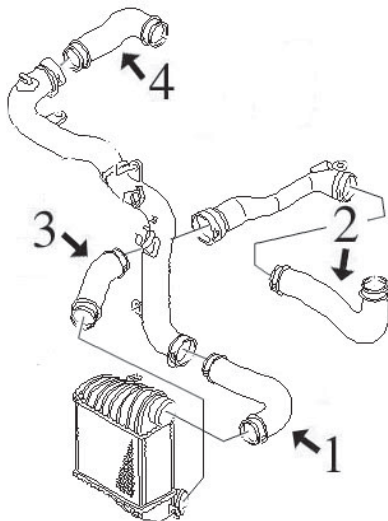

- 1- 9091 tubo flexible de intercooler a tubo, TDi de 150CV
- 9092 tubo flexible de intercooler a tubo, TDi de 130CV
- 2- n/d tubo flexible a intercooler
- 3- 9093 tubo flexible de intercooler a tubo, TDi de 150CV
- 9092 tubo flexible de intercooler a tubo, TDi de 130CV
- 4- 9094 tubo flexible de tubo rígido a colector de aspiración, TDi de 130CV



SKODA OCTAVIA-1 (1997-2004)

<p><b>¡Nuevo!</b></p>  <p><b>9064</b>  <math>\text{Ø } 60 \times 70</math> largo 58 mm                      tubo flexible de intercooler a tubo rígido                      r.o. 1J0145834A</p>	<p><b>¡Nuevo!</b></p>  <p><b>9068</b>                      tubo flexible de tubo rígido a colector                      r.o. 1J0145838B</p>	<p><b>¡Nuevo!</b></p>  <p><b>9069</b>                      tubo de empalme hasta 5/99, 90-110CV                      r.o. 1J0145828H</p>
<p><b>¡Nuevo!</b></p>  <p><b>9070</b>                      tubo de empalme desde 5/99, 90-110CV                      r.o. 1J0145828T</p>	<p><b>¡Nuevo!</b></p>  <p><b>9091</b>                      tubo de intercooler a tubo rígido 150CV                      r.o. 1J0145834AE</p>	<p><b>¡Nuevo!</b></p>  <p><b>9092</b>                      tubo flexible de intercooler a tubo rígido                      r.o. 1J0145834AB</p>
<p><b>¡Nuevo!</b></p>  <p><b>9093</b>                      tubo de intercooler a tubo rígido 150CV                      r.o. 1J0145834AA</p>	<p><b>¡Nuevo!</b></p>  <p><b>9094</b>                      tubo de tubo rígido a colector de aspiración                      r.o. 1J0145838AF</p>	

SUSPENSION DELANTERA y SOPORTES DE MOTOR:

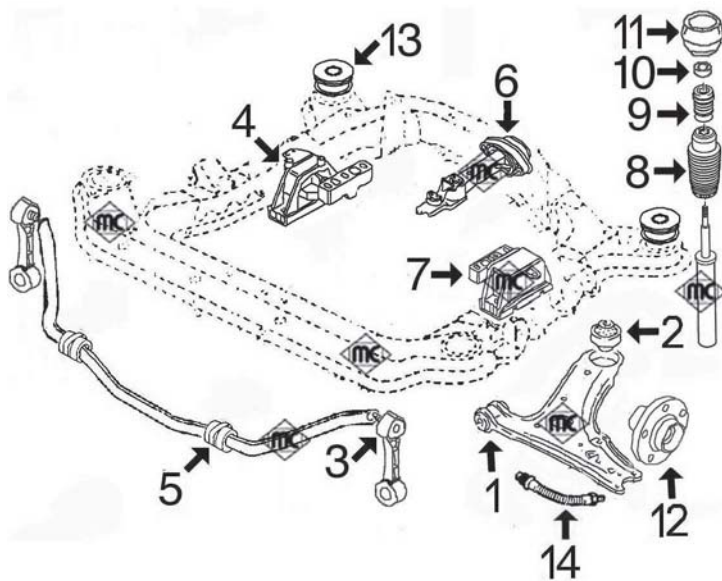

- 1- 542 silentbloc anterior trapecio delantero
- 2- 2963 silentbloc posterior trapecio delantero
- 3- 4250 bieleta puntal barra estabilizadora (plástico)
- 4249 bieleta puntal barra estabilizadora (metal)
- 4- 4368 soporte motor derecho 1.4-1.6 (105cv y 16v)-2.3V5
- 4186 soporte motor derecho 1.6 (100 y 102cv)-1.8-2.0 1.9SDi-1.9TDi
- 5- 4369 goma para barra estabilizadora de Ø 20 y 21 mm
- 4321 goma para barra estabilizadora de Ø 23 mm
- 6- 4133 soporte motor trasero
- 7- 4187 soporte motor izquierdo
- 8- 4324 capuchón amortiguador delantero
- 9- 4298 tope poliuretano amortiguador
- 10- 4128 rodamiento soporte amortiguador
- 11- 4177 soporte amortiguador completo con rodamiento
- 12- 90063 buje de rueda delantera
- 13- 4134 soporte sub-chasis trasero
- 14- 96013 latiguillo freno delantero (435 mm)

SUSPENSION TRASERA:

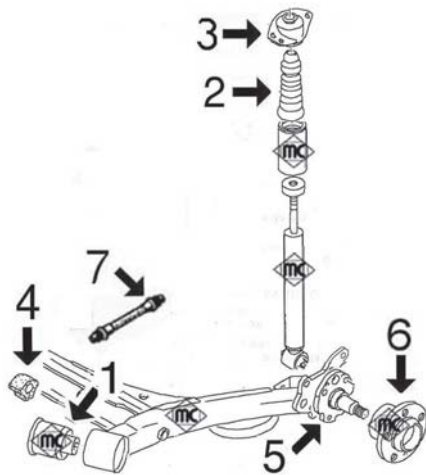

- 1- 4310 silentbloc brazo suspensión trasero
- 2- 4312 tope poliuretano amortiguador trasero
- 3- 4311 soporte amortiguador trasero
- 4- 2824 goma barra estabilizadora
- 5- n/d mangueta brazo trasero
- 6- 90521 buje rueda trasera
- 7- 96014 latiguillo freno trasero (165 mm)



**542**  
silentbloc anterior trapecio delantero  
r.o.357407182



**2824**  
goma barra estabilizadora trasera  
r.o.871511423



**2963**  
silentbloc posterior trapecio delantero  
r.o.1J0407181



**4128**  
rodamiento soporte amortiguador delantero  
r.o.1J0412249



**4133**  
soporte motor trasero  
r.o.1J0199851AA



**4134**  
silentbloc sub-chasis trasero  
r.o.1J0199429

## SKODA OCTAVIA-1 (1997-2004)



**4177**  
soporte amortiguador delantero completo  
con rodamiento, r.o. 1J0412331C

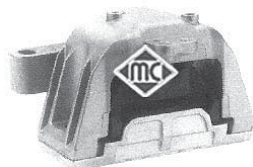

**4186**  
soporte motor derecho 1.6(100 y 102cv)-1.8-  
-2.0-1.9TDi-1.9SDi, r.o. 1J0199262BF



**4187**  
soporte motor izquierdo  
r.o. 1J0199555AJ/AK



**4249**  
bieleta puntal barra estabilizadora (metálica)  
r.o. 1J0411315G



**4250**  
bieleta puntal barra estabilizadora (plástico)  
r.o. 1J0411315C



**4298**  
tope poliuretano amortiguador delantero  
r.o. 1H0412303B



**4310**  
silentbloc brazo trasero suspensión  
r.o. 1J0501541C



**4311**  
soporte amortiguador trasero  
r.o. 1J0512353C



**4312**  
tope poliuretano amortiguador trasero  
r.o. 1J0512131-1J0512131B



**4321**  
goma para barra estabilizadora de Ø 23 mm  
r.o. 1J0411314G



**4324**  
capuchón amortiguador delantero  
r.o. 357413175A

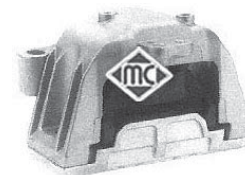

**4368**  
soporte motor derecho 1.4-1.6 (de 105cv)  
-1.6/16v y 2.3V5, r.o. 1J0199262BK/BH

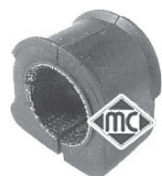

**4369**  
goma para barra estabilizadora de Ø 20 y  
21 mm, r.o. 1J0411314C



**90063**  
buje rueda delantera  
r.o. 1J0407613C



**90521**  
buje rueda trasera  
r.o. 1J0598477























**96013**  
latiguillo freno delantero (435 mm)  
r.o. 1J0611701

















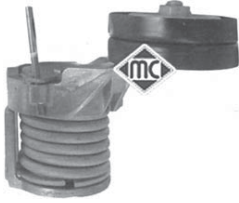
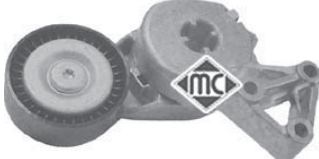

**96014**  
latiguillo freno trasero (165 mm)  
r.o. 6X0611775

## SKODA OCTAVIA-1 (1997-2004)

<p><b>¡Nuevo!</b></p>  <p><b>4758</b> varilla nivel aceite 1.4/16v-1.6/16v r.o.</p>	<p><b>¡Nuevo!</b></p>  <p><b>4795</b> varilla nivel aceite 1.6/8v-1.8/20v y 2.0 r.o.</p>	<p><b>¡Nuevo!</b></p>  <p><b>4759</b> varilla nivel aceite 1.9TDi-SDi r.o.</p>
 <p><b>4355</b> guía varilla nivel aceite 1.4/16v-1.6/16v r.o.030115636A</p>	 <p><b>3568</b> guía varilla nivel aceite 1.6/8v r.o.06A103663B</p>	 <p><b>3553</b> guía varilla nivel aceite 1.8/20v r.o.06A103663C</p>
 <p><b>3571</b> guía varilla nivel aceite 1.9SDi-1.9TDi r.o.038103663</p>	<p><b>¡Nuevo!</b></p>  <p><b>3708</b> tapón llenado combustible (sin llave) r.o. 1J0201553C</p>	 <p><b>4365</b> juego tornillos sujeción tapa motor r.o.028103638G+028103665+028103937</p>
<p><b>¡Nuevo!</b></p>  <p><b>4421</b> polea cigueñal 1.9TDi-SDi todos hasta '03 r.o.038105243</p>	<p><b>¡Nuevo!</b></p>  <p><b>4480</b> polea cigueñal 1.9TDi desde '03- r.o.03G105243</p>	<p><b>¡Nuevo!</b></p>  <p><b>4494</b> polea cigueñal 1.9SDi desde '03- r.o.038105243L</p>
 <p><b>4405</b> polea cigueñal 1.8 gasolina r.o.06A105243F</p>	<p><b>¡Nuevo!</b></p>  <p><b>3711</b> tubo de aire a caudalímetro 1.6-1.8 r.o. 1J0129684N</p>	<p><b>¡Nuevo!</b></p>  <p><b>3718</b> tubo de aire a caudalímetro 1.9Diesel r.o.</p>
<p><b>¡Nuevo!</b></p>  <p><b>4749</b> casquillo guía embrague 1.8-1.9TDi-2.3 r.o.02A141180A</p>	<p><b>¡Nuevo!</b></p>  <p><b>4772</b> leva embrague 1.4/16v-1.6/16v-1.6/8v-1.9SDi r.o.02K141709A</p>	<p><b>¡Nuevo!</b></p>  <p><b>3691</b> articulación cambio 1.9TDi hasta 5/'99 r.o.</p>
 <p><b>4326</b> bioleta reenvío cambio velocidades (excepto reenvío por cable), r.o. 1J0711183D</p>	 <p><b>4327</b> bioleta reenvío cambio velocidades (excepto reenvío por cable), r.o. 1J0711596E</p>	 <p><b>4328</b> bioleta reenvío cambio velocidades (excepto reenvío por cable), r.o. 1J0711803C</p>

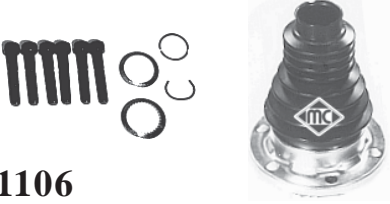

## SKODA OCTAVIA-1 (1997-2004)

<p><b>¡Nuevo!</b></p>  <p><b>3689</b> válvula filtro gasoil r.o. 1J0127247A</p>	<p><b>¡Nuevo!</b></p>  <p><b>3720</b> tapa correa distribución 1.6-100CV r.o. 06A109108S</p>	<p><b>¡Nuevo!</b></p>  <p><b>4968</b>      <b>Ø 17x76 mm</b> rodillo en tensor correa alternador r.o.</p>
<p><b>¡Nuevo!</b></p>  <p><b>4767</b>      <b>Ø 65 mm</b> rodillo tensor correa alternador 1.9D r.o. 038145276</p>	<p><b>¡Nuevo!</b></p>  <p><b>4769</b>      <b>Ø 75,5 mm</b> rodillo tensor correa alternador 1.9D r.o. 038145278</p>	<p><b>¡Nuevo!</b></p>  <p><b>4922</b>      <b>Ø 17x70 mm</b> rodillo en tensor correa alternador 1.9D r.o.</p>
<p><b>¡Nuevo!</b></p>  <p><b>5044</b> tensor correa alternador 1.9TDi r.o. 038903315D/P</p>	<p><b>¡Nuevo!</b></p>  <p><b>4770</b> tensor correa alternador 1.4-1.6 sin a/c r.o. 030145299F</p>	<p><b>¡Nuevo!</b></p>  <p><b>4771</b> rodillo tensor correa alternador 1.4 r.o. 028145278M</p>
<p><b>¡Nuevo!</b></p>  <p><b>5009</b> tensor correa alternador con a/c r.o. 032145299A</p>	<p><b>¡Nuevo!</b></p>  <p><b>5010</b> tensor correa alternador 1.6-1.8-2.0 r.o. 06A903315E</p>	<p><b>¡Nuevo!</b></p>  <p><b>5039</b> tensor correa alternador 1.9SDi r.o. 038903315K</p>
<p><b>¡Nuevo!</b></p>  <p><b>4944</b> tensor correa alternador 1.9TDi r.o. 038903315C</p>	<p><b>¡Nuevo!</b></p>  <p><b>4997</b>      <b>Ø 61/55 mm, H=41 mm</b> polea de alternador de rueda libre r.o. 022903119A</p>	<p><b>¡Nuevo!</b></p>  <p><b>4999</b>      <b>Ø 61/55 mm, H=41 mm</b> polea de alternador de rueda libre r.o. 038903119</p>
<p><b>4296</b> kit reparación distribuidor Magneti-Marelli 1.4-1.6 (casquillo sinterizado del eje rotor)</p> 	<p><b>1921</b> kit fuelle transm. l/rda 1.4-1.6(105cv)-1.6/16v y 1.9SDi (Ø 26-78 mm), r.o. 1J0498203</p> 	<p><b>1297</b> kit fuelle transm. l/rda. 1.6(100-102cv)-1.8- 2.0 y TDi de 90-100-110cv, (Ø 25-86 mm)</p> 
<p><b>1102</b> kit fuelle transmisión l/rueda TDi de 115-130- y 150cv (Ø 29-98 mm), r.o. 1J0498203A</p> 	<p><b>1106</b> kit fuelle transm. l/cambio 1.4-1.6(100-105cv) 1.6/16v y 1.9SDi (Ø 27-94 mm)</p> 	<p><b>1560</b> kit fuelle transm. izqda. l/cambio 1.8-2.0-1.6 (100-102cv) y 1.9TDi (Ø 21-100 mm)</p> 

SKODA OCTAVIA-1 (1997-2004)



**1637**  
kit fuelle **transm. dcha.** l/cambio 1.8-2.0-1.6  
(100-102cv) y 1.9TDi (Ø 21-100 mm)



**1192**  
kit fuelle transmisión l/cambio 1.9TDi-1.8-  
-2.0 (Ø 27-100 mm), r.o. 6Q0498201A



**1479**  
fuelle cremallera dirección  
r.o. 1J0422831B



**4121**  
soporte catalizador  
r.o. 1J0253144H



**4364**  
soporte catalizador  
r.o. 1H0253144E



**4122**  
soporte presilenciador 1.4-1.6  
r.o. 1J0253144



**2426**  
soporte presilenciador 1.9TDi-1.9SDi  
r.o. 1H0253147B



**4123**  
soporte presilenciador 1.6-1.8-2.0  
r.o. 1J0253144G



**4098**  
soporte silenciador trasero  
r.o. 1J0253144J



**3575**  
juego grapas plástico alzacristales  
r.o. (no hay despiece)



**4248**  
tuerca rueda M14x1,5x27  
r.o. 8D0601139D



**2916**  
tapón cárter de aceite  
r.o. N90813201

**¡Nuevo!**

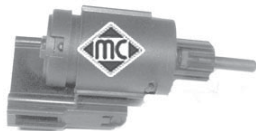

**3738**  
interruptor luz de freno (4 polos)  
r.o. 1J0945511C/D

**¡Nuevo!**



**3739**  
interruptor luz de freno (2 polos)  
r.o. 191945515-191945515A/B



**3621**  
tapón llenado aceite motor  
r.o. 026103485

SUSPENSION DELANTERA y SOPORTES DE MOTOR:

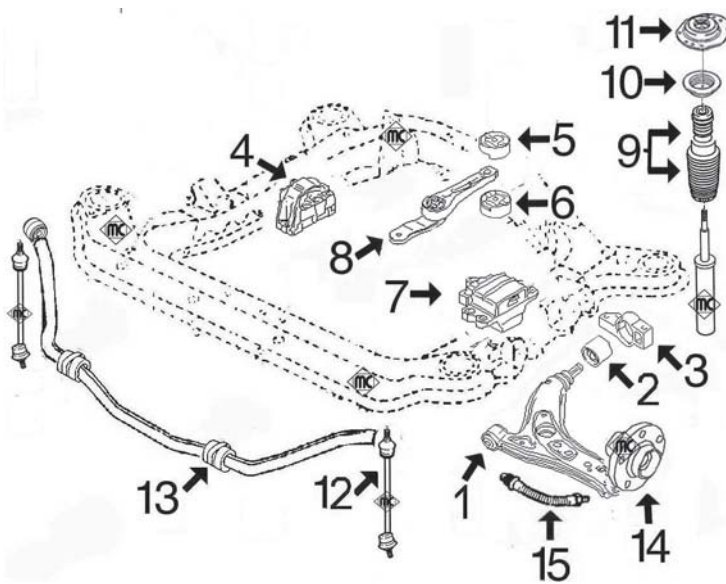

- |     |      |   |
|-----|------|---|
| 1-  | 4864 | silentbloc anterior trapecio delantero  |
| 2-  | 4691 | silentbloc posterior trapecio delantero   |
| 3-  | 4862 | silentbloc posterior trapecio delantero izquierdo completo con cuerpo de aluminio |
|     | 4863 | silentbloc posterior trapecio delantero derecho completo con cuerpo de aluminio   |
| 4-  | 4865 | soporte motor derecho 1.4-1.6-1.9TDi-2.0TDi                                       |
|     | 4866 | soporte motor derecho 1.4FSi-1.6FSi-2.0GTi  |
| 5-  | 4859 | silentbloc superior soporte trasero motor   |
| 6-  | 4860 | silentbloc inferior soporte trasero motor   |
| 7-  | 4867 | soporte motor izquierdo 1.4/16v-1.6-1.6/16v-1.9TDi-2.0FSi                         |
|     | 4868 | soporte motor izquierdo 1.9TDi (cambio manual automatizado)-2.0TDi                |
| 8-  | 4872 | bieleta soporte motor trasero 1.4-1.6 gasolina                                    |
|     | 4987 | bieleta soporte motor trasero 1.9TDi-2.0TDi-2.0 gasolina y Automáticos todos      |
| 9-  | 4765 | juego capuchón y tope poliuretano amortiguador                                    |
| 10- | 4789 | rodamiento soporte amortiguador   |
| 11- | 4871 | soporte amortiguador completo con rodamiento                                      |
| 12- | 4874 | bieleta puntal barra estabilizadora   |
| 13- | 4861 | goma barra estabilizadora   |
| 14- | n/d  | buje rueda delantera  |
| 15- | n/d  | latiguillo freno delantero  |



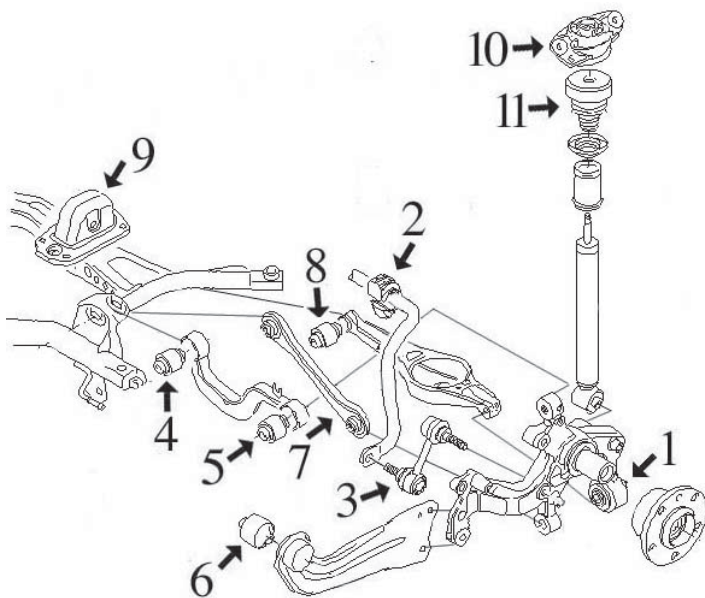















SUSPENSION TRASERA:



- |     |      |                                       |
|-----|------|---------------------------------------|
| 1-  | n/d  | silentbloc mangueta a brazo inferior  |
| 2-  | 4861 | goma barra estabilizadora             |
| 3-  | 4967 | bieleta puntal barra estabilizadora   |
| 4-  | n/d  | silentbloc interior brazo transversal |
| 5-  | n/d  | silentbloc exterior brazo transversal |
| 6-  | n/d  | silentbloc en brazo oscilante         |
| 7-  | n/d  | barra de acoplamiento                 |
| 8-  | n/d  | silentbloc interior brazo inferior    |
| 9-  | n/d  | soporte elástico                      |
| 10- | 4873 | soporte amortiguador trasero          |
| 11- | n/d  | tope poliuretano                      |



## SKODA OCTAVIA-2 (2004-)





<p><b>iNuevo!</b></p>  <p><b>4691</b> silentbloc posterior trapezio delantero r.o. 1K0407183A/B</p>	<p><b>iNuevo!</b></p>  <p><b>4765</b> juego tope poliuretano y capuchón amortiguador delantero, r.o. 6N0412375A</p>	<p><b>iNuevo!</b></p>  <p><b>4789</b> rodamiento soporte amortiguador delant. r.o. 6N0412249C</p>
<p><b>iNuevo!</b></p>  <p><b>4859</b> soporte superior tirante trasero de motor r.o. 1K0199867</p>	<p><b>iNuevo!</b></p>  <p><b>4860</b> soporte inferior tirante trasero de motor r.o. 1K0199868</p>	<p><b>iNuevo!</b></p>  <p><b>4861</b> goma barra estabilizadora delantera y tras. r.o. 1K0511327AP</p>
<p><b>iNuevo!</b></p>  <p><b>4862</b> silentbloc posterior trapezio del. <b>izquierdo</b> completo, r.o. 1K0199231G</p>	<p><b>iNuevo!</b></p>  <p><b>4863</b> silentbloc posterior trapezio del. <b>derecho</b> completo, r.o. 1K0199232G</p>	<p><b>iNuevo!</b></p>  <p><b>4864</b> silentbloc anterior trapezio delantero r.o. 1K0407182</p>
<p><b>iNuevo!</b></p>  <p><b>4865</b> soporte motor derecho 1.4-1.6-1.9D-2.0D r.o. 1K0199262L/M</p>	<p><b>iNuevo!</b></p>  <p><b>4866</b> soporte motor derecho 1.4FSi-1.6FSi-2.0GTi r.o. 1K0199262AA/AJ/T</p>	<p><b>iNuevo!</b></p>  <p><b>4867</b> soporte motor izquierdo 1.4-1.6-1.9D-2.0D r.o. 1K0199555L/M</p>
<p><b>iNuevo!</b></p>  <p><b>4868</b> soporte motor izquierdo 2.0TDi y 1.9TDi cambio semiautomático, r.o. 1K0199555Q/T</p>	<p><b>iNuevo!</b></p>  <p><b>4871</b> soporte amortiguador delantero completo con rodamiento, r.o. 1K0412331B/C</p>	<p><b>iNuevo!</b></p>  <p><b>4872</b> soporte-tirante motor trasero 1.4-1.6 r.o. 1K0199851K</p>
<p><b>iNuevo!</b></p>  <p><b>4873</b> soporte amortiguador trasero r.o. 1K0512353G/H/J</p>	<p><b>iNuevo!</b></p>  <p><b>4874</b> bieleta puntal barra estabilizadora delantera r.o. 1K0411315D/J</p>	<p><b>iNuevo!</b></p>  <p><b>4967</b> bieleta puntal barra estabilizadora trasera r.o. 1K0505465K</p>
<p><b>iNuevo!</b></p>  <p><b>4987</b> soporte-tirante motor trasero 1.9TDi-2.0TDi-2.0 gasolina y Automáticos, r.o. 1K0199851L</p>		

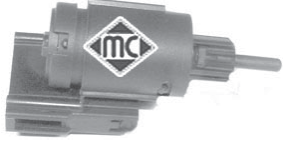

# SKODA OCTAVIA-2 (2004-)

<p><b>4480</b> polea cigueñal 1.9TDi-2.0TDi r.o.03G105243</p> 	<p><b>4405</b> polea cigueñal 2.0FSi r.o.06A105243E</p> 	<p><b>4365</b> juego sujeción tapa motor TDi r.o.</p> 
<p><b>3621</b> tapón llenado aceite motor r.o.06A103485</p> 	<p><b>4793</b> varilla nivel aceite 1.4/16v-1.6/16v r.o.030115611R</p> 	<p><b>4759</b> varilla nivel aceite 1.9TDi-2.0TDi r.o.038115611B</p> 
<p><b>4355</b> guía varilla nivel aceite 1.4/16v-1.6/16v r.o.030115636A</p> 	<p><b>3597</b> pipa de agua 1.6 r.o.06A121121C</p> 	<p><b>3721</b> juego conectores manguitos radiador r.o.6Q0122291F+1J0122291</p> 
<p><b>3677</b> tapón botella de expansión r.o.03B121321</p> 	<p><b>4749</b> casquillo guía embrague con retén r.o.02A141180A</p> 	<p><b>4770</b> tensor correa alternador 1.4 con aire ac. r.o.030145299F</p> 
<p><b>1479</b> fuelle cremallera dirección r.o.1J0422831B</p> 	<p><b>1921</b> kit fuelle transmisión lado rueda bocas de Ø 26-78 mm, r.o. 1J0498203</p> 	<p><b>1297</b> kit fuelle transmisión lado rueda bocas de Ø 25-86 mm, r.o. 1H0407285A</p> 
<p><b>1102</b> kit fuelle transmisión lado /rueda bocas de Ø 29-98 mm, r.o. 1K0498203A</p> 	<p><b>1106</b> kit fuelle transmisión lado cambio bocas de Ø 27-94 mm, r.o. 1K0498201B</p> 	<p><b>1192</b> kit fuelle transmisión lado cambio bocas de Ø 27-100 mm, r.o. 1K0498201</p> 
<p><b>2308</b> kit fuelle transmisión lado cambio bocas de Ø 27-100 mm, r.o. 1K0498201A</p> 	<p><b>3708</b> tapón llenado combustible (sin llave) r.o.1J0201553C</p> 	

SKODA OCTAVIA-2 (2004-)

<p><b>¡Nuevo!</b></p>  <p><b>4767</b> rodillo tensor correa alternador r.o.038145276</p> <p>Ø 65 mm</p>	<p><b>¡Nuevo!</b></p>  <p><b>4769</b> rodillo tensor correa alternador 5 canales r.o.038145278</p> <p>Ø 75,5 mm</p>	<p><b>¡Nuevo!</b></p>  <p><b>4922</b> rodillo en tensor correa alternador r.o.</p> <p>Ø 17x70 mm</p>
<p><b>¡Nuevo!</b></p>  <p><b>4968</b> rodillo en tensor correa alternador r.o.</p> <p>Ø 17x76 mm</p>	<p><b>¡Nuevo!</b></p>  <p><b>3738</b> interruptor luz de freno (4 polos) r.o.1J0945511D/C</p>	 <p><b>2916</b> tapón cárter de aceite con junta r.o.N90813201</p>
<p><b>¡Nuevo!</b></p>  <p><b>4770</b> tensor correa alternador 1.4 r.o.030145299F</p>	<p><b>¡Nuevo!</b></p>  <p><b>5010</b> tensor correa alternador 1.6-1.8-2.0 r.o.06A903315E</p>	<p><b>¡Nuevo!</b></p>  <p><b>4997</b> polea de alternador de rueda libre r.o.022903119A</p> <p>Ø 61/55 mm, H=41 mm</p>
<p><b>¡Nuevo!</b></p>  <p><b>4869</b> soporte silenciador trasero r.o.1K0253144AH</p>	<p><b>¡Nuevo!</b></p>  <p><b>4870</b> soporte escape r.o.1K0253144AP</p>	 <p><b>2766</b> soporte escape r.o.8D0253147E</p>
 <p><b>4248</b> tuerca rueda M14x1,5x27 r.o.8D0601139D</p>		

TOYOTA CARINA E - YARIS



**4233**  
silentbloc anterior trapecio delantero  
CARINAE, r.o. 486554-20160



**4215**  
silentbloc posterior trapecio delantero  
CARINAE, r.o. 48655-20140



**2373**  
kit fuelle transmisión l/rueda CARINAE  
r.o.



**4294**  
silentbloc anterior trapecio delantero  
YARIS, r.o.



**4295**  
silentbloc posterior trapecio delantero  
YARIS, r.o.



**3609**  
tapón de radiador 1.1 bar  
r.o.



**2318**  
tapón cárter de aceite M12x150  
r.o.



**2052**  
arandela cobre para tapón cárter Ø 12 mm  
r.o.



**2053**  
arandela cobre para tapón cárter Ø 14 mm  
r.o.



**095**  
soporte escape  
r.o.

# VOLKSWAGEN CADDY (1996-2004)

## CANALIZACIONES DE AGUA

**CADDY 1.4/8v 1.6/8v** motores AEX-AKV-APQ de 60cv hasta '03 motor AEE de 75cv hasta '00

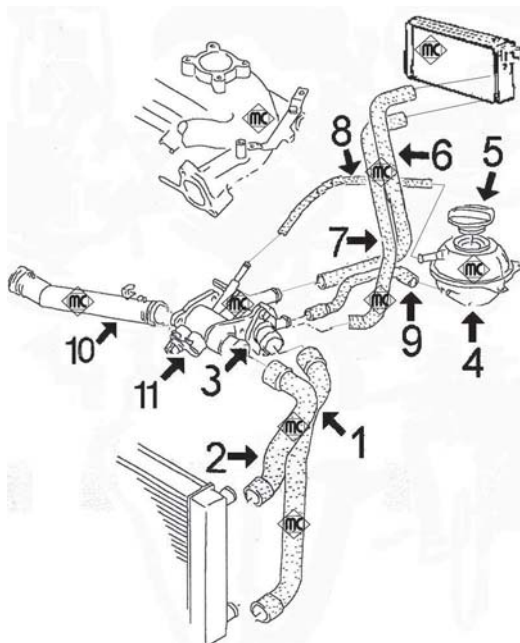

- 1- 8834 mgto inferior radiador
  - 2- 8400 mgto superior radiador
  - 3- 3592 kit de termostato completo con tapa y junta  
3541 tapa de termostato
  - 4- 3504 botella de expansión
  - 5- 3506 tapón botella de expansión
  - 6- 8845 mgto entrada agua a calefactor sin toma para sensor  
8821 mgto entrada agua a calefactor con toma para sensor
  - 7- 8846 mgto retorno agua de calefactor
  - 8- 116 mgto sobrante de botella a mgto inferior y caja de termostato: cortar de rollo MC-116 Ø 8x14 mm, long. aprox. 350 mm
  - 9- 8822 mgto de cuerpo termostato a botella
  - 10- 3625 tubo de agua (plástico) con juntas tóricas
  - 11- 3615 cuerpo de termostato completo con termostato, tapa y accesorios
- 8811 mgto desvaporizador

**CADDY 1.6** motor 1F de 75 cv hasta 5/'97

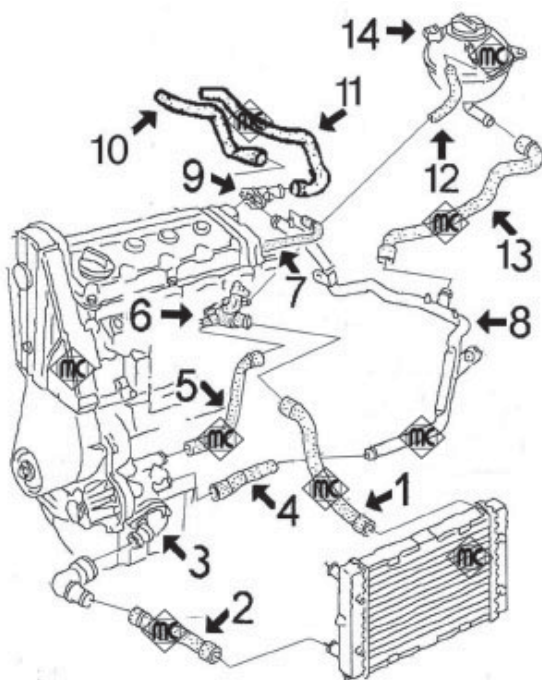

- 1- 8404 mgto superior radiador
  - 2- 8403 mgto inferior radiador sin aire acondicionado  
8402 mgto inferior radiador con aire acondicionado
  - 3- 3537 tapa de termostato  
3667 tapa de termostato completa con codo y junta
  - 4- 8386 mgto de bomba de agua a tubo
  - 5- 8383 mgto de bomba de agua a culata
  - 6- 3522 brida en culata conexión mgto
  - 7- 8391 mgto de tubo metálico a colector
  - 8- 3084 tubo de agua metálico
  - 9- 3517 boquilla en culata
  - 10- 8395 mgto de tubo metálico a calefactor
  - 11- 8396 mgto de culata a calefactor
  - 12- 116 mgto de sobrante de botella a radiador, cortar de rollo MC-116 Ø 8x15 mm longitud 750 mm
  - 13- 8378 mgto de tubo metálico a botella
  - 14- 3504 botella de expansión con sensor de nivel  
3506 tapón botella de expansión
- 8224 mgto desvaporizador  
8226 mgto desvaporizador



## VOLKSWAGEN CADDY (1996-2004)

**CADDY 1.4/16v motor AUA de 75CV hasta '03**

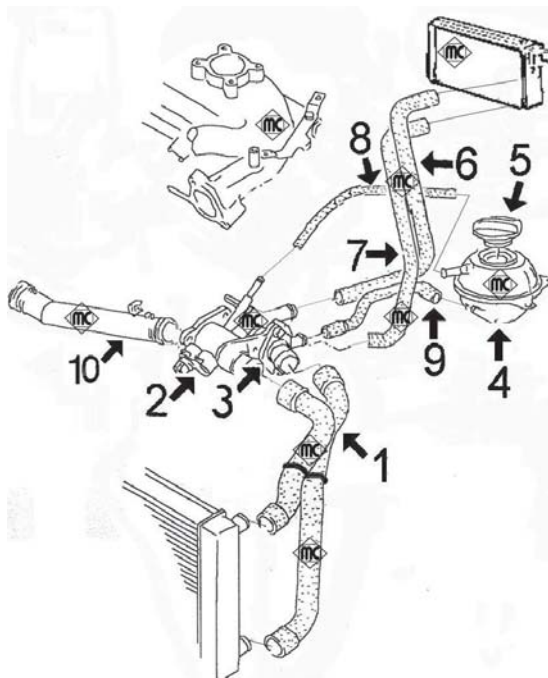

- 1- 9083 mgtto superior e inferior radiador
- 2- 3615 cuerpo de termostato completo con termostato, tapa y accesorios
- 3- 3592 kit de termostato completo con tapa y junta  
3541 tapa de termostato
- 4- 3504 botella de expansión
- 5- 3506 tapón botella de expansión
- 6- 8845 mgtto entrada agua a calefactor
- 7- 8846 mgtto retorno agua de calefactor
- 8- 116 mgtto sobrante de botella a mgtto inferior y caja de termostato: cortar de rollo MC-116 Ø 8x14 mm, long. aprox. 350 mm
- 9- 8822 mgtto de cuerpo termostato a botella
- 10- 3625 tubo de agua (plástico) con juntas tóricas

8811 mgtto desvaporizador

**CADDY 1.9 Diesel  
1.9 SDi  
1.7 SDi**

**motor 1Y de 64cv hasta '03  
motor AEY de 64cv hasta '00  
motor AHB de 64cv hasta '03**

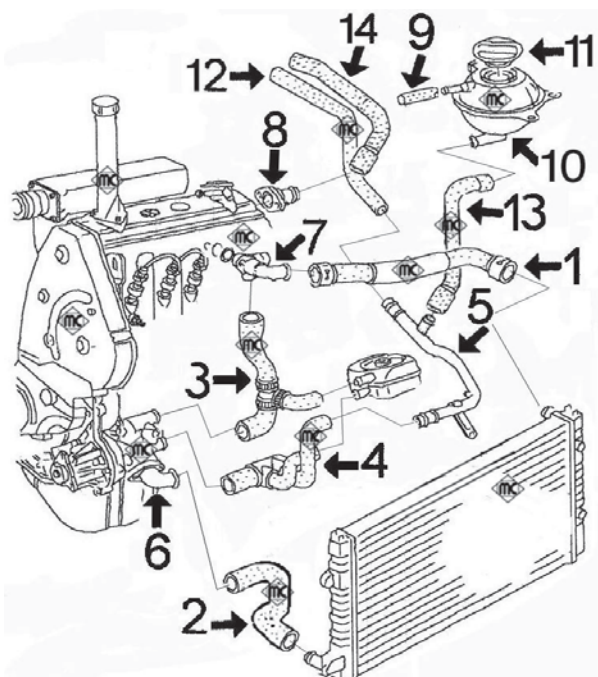

- 1- 8417 mgtto superior radiador
- 2- 8406 mgtto inferior radiador 1.9 Diesel  
8399 mgtto inferior radiador 1.7SDi-1.9SDi
- 3- 8382 mgtto de bomba agua a racor en culata
- 4- 8384 mgtto de bomba agua a intercambiador y tubo metálico
- 5- 3084 tubo de agua metálico 1.9 Diesel  
3094 tubo de agua metálico 1.7SDi-1.9SDi
- 6- 3537 tapa de termostato  
3667 tapa de termostato completa con codo y junta
- 7- 3527 brida en culata 1.9 Diesel  
3542 racor en culata 1.7SDi-1.9SDi
- 8- 3517 boquilla lateral en culata
- 9- 116 mgtto sobrante de botella: cortar de rollo MC-116 Ø 8x14 mm, long. aprox. 400 mm
- 10- 3504 botella de expansión
- 11- 3506 tapón botella de expansión
- 12- 8395 mgtto de tubo metálico a calefactor
- 13- 8378 mgtto de tubo metálico a botella expansión
- 14- 8396 mgtto de culata a calefactor

## VOLKSWAGEN CADDY (1996-2004)

CADDY 1.9 TDi  
1.9 SDi

motor ALH de 90cv desde '00  
motor AYQ de 64cv desde '00

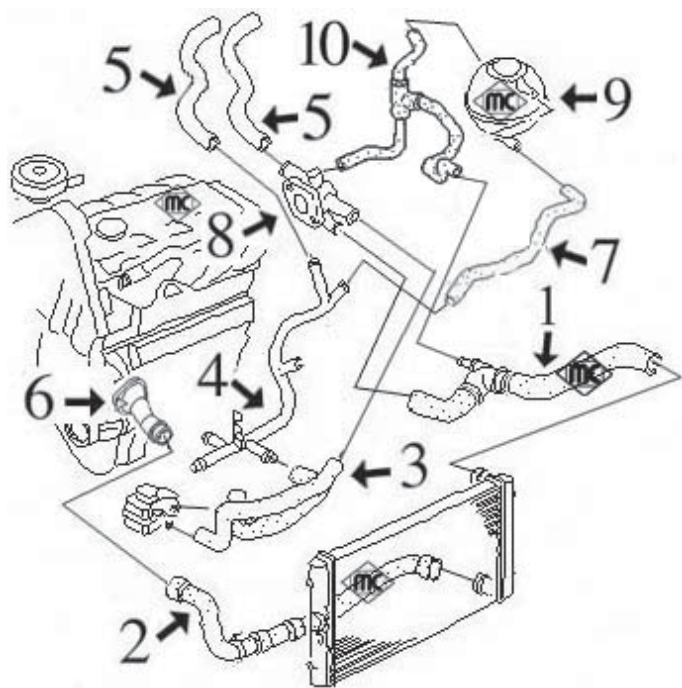





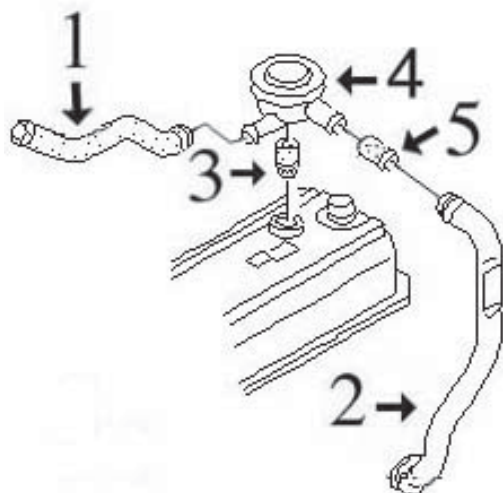

- 1- 9085 mgto superior radiador completo
- 2- 9084 mgto inferior radiador
- 3- 9080 mgto doble a intercambiador
- 4- 3186 tubo de agua metálico
- 5- 9088 juego mgtos entrada/salida calefactor
- 6- 3590 boquilla entrada agua a bloque motor
- 7- 9090 mgto de tubo metálico a botella
- 8- 3591 caja de agua (plástico) en culata
- 9- 3504 botella de expansión  
3506 tapón botella de expansión
- 10- 9089 mgto de botella a caja de agua en culata

### TUBOS DESVAPORIZADORES 1.9D - TD - TDi - SDi (hasta 5/'99):

















- 1- 8895 mgto de válvula desvaporizadora 1.9TDi  
8385 mgto de válvula desvaporizadora 1.9D
- 2- 3644 tubo plástico de válvula a cárter
- 3- 2669 junta válvula desvaporizadora
- 4- 3719 válvula desvaporizadora
- 5- 8385 mgto de válvula desvaporizadora 1.9D-TD (no TDi!)

## VOLKSWAGEN CADDY (1996-2004)











  <p><b>8224</b> mgto desvaporizador 1.6(1F) r.o.051103493A-048103493A</p>	  <p><b>8226</b> mgto desvaporizador 1.6(1F) r.o.050103493A</p>	  <p><b>8377</b> mgto depresor servofreno todos mods. r.o.321611939E</p>
 <p><b>8378</b> mgto de tubo metálico a botella 1.6 (1F) r.o.1H0121109-1H0121109A</p>	 <p><b>8382</b> mgto de bomba a brida en culata D-SDi r.o.028121053Q/S/L/P</p>	 <p><b>8383</b> mgto de bomba a brida en culata 1.6 (1F) r.o.037121053H</p>
 <p><b>8384</b> mgto de bomba a intercambiador y tubo Diesel y SDi, r.o.037122058B</p>	  <p><b>8385</b> mgto desvaporizador Diesel y SDi r.o.028103493E</p>	 <p><b>8386</b> mgto de bomba a tubo metálico 1.6 (1F) r.o.037121063A</p>
 <p><b>8391</b> mgto de tubo metálico a colector 1.6 (1F) r.o.051121056</p>	 <p><b>8395</b> mgto calefactor 1.6(1F)-Diesel y SDi r.o.1H0819373C</p>	 <p><b>8396</b> mgto calefactor 1.6(1F)-Diesel y SDi r.o.1H0819371</p>
 <p><b>8399</b> mgto inferior radiador 1.7SDi-1.9SDi r.o.6K0121051K/H</p>	 <p><b>8400</b> mgto superior radiador 1.4-1.6(AEE) r.o.6K0121101</p>	 <p><b>8402</b> mgto inferior radiador 1.6(1F) con aire ac. r.o.6K0121051C</p>
 <p><b>8403</b> mgto inferior radiador 1.6(1F) sin aire acond. r.o.6K0121051A</p>	 <p><b>8404</b> mgto superior radiador 1.6(1F) r.o.6K0121101A</p>	 <p><b>8406</b> mgto inferior radiador 1.9Diesel (1Y) r.o.1H0121051B</p>
 <p><b>8417</b> mgto superior radiador Diesel y SDi r.o.6K0121101G</p>	  <p><b>8812</b> mgto desvaporizador 1.6 r.o.1H0103493</p>	 <p><b>8821</b> mgto entrada a calefactor 1.4-1.6 con toma para sensor, r.o.</p>

## VOLKSWAGEN CADDY (1996-2004)

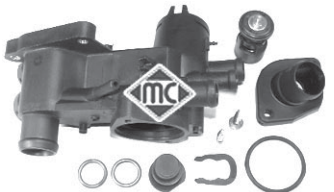
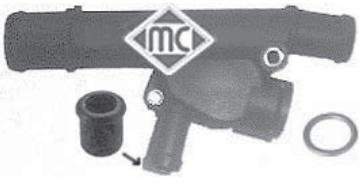
 <p><b>8822</b> mgto de caja termostato a botella 1.4-1.6 r.o.</p>	 <p><b>8834</b> mgto inferior radiador 1.4-1.6 r.o.</p>	
 <p><b>8845</b> mgto entrada a calefactor 1.4-1.6 r.o.</p>	 <p><b>8846</b> mgto retorno calefactor 1.4-1.6 r.o.</p>	<p><b>iNuevo!</b></p>  <p><b>8895</b> mgto desvaporizador 1.9TDi r.o.028103493S</p>
<p><b>iNuevo!</b></p>  <p><b>9080</b> mgto de intercambiador a tubo 1.9SDi-TDi r.o.</p>	<p><b>iNuevo!</b></p>  <p><b>9083</b> mgto superior/inferior 1.4-16v '00- r.o.</p>	<p><b>iNuevo!</b></p>  <p><b>9084</b> mgto inferior radiador 1.9SDi-1.9TDi '00- r.o.</p>
<p><b>iNuevo!</b></p>  <p><b>9085</b> mgto sup radiador 1.9SDi-TDi '00- r.o.</p>	<p><b>iNuevo!</b></p>  <p><b>9088</b> jgo mgto calefactor 1.9SDi-TDi '00- r.o.</p>	<p><b>iNuevo!</b></p>  <p><b>9089</b> mgto de culata a botella 1.9SDi-TDi r.o.</p>
<p><b>iNuevo!</b></p>  <p><b>9090</b> mgto de tubo metálico a botella 1.9TDi-SDi r.o.</p>	<p><b>iNuevo!</b></p>  <p><b>3722</b> tubo desvaporizador 1.9TDi desde 5/'99 r.o.038103493P</p>	

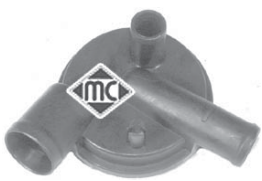

## VOLKSWAGEN CADDY (1996-2004)

 <p><b>3517</b> boquilla en culata 1.6(1F)-Diesel y SDi r.o.037121145</p>	 <p><b>3522</b> brida en culata 1.6(1F) r.o.037121133F-037121132E-037121132G</p>	 <p><b>3527</b> brida en culata Diesel (1Y) r.o.068121133AB/AE</p>
 <p><b>3537</b> tapa de termostato 1.6(1F)-Diesel-SDi r.o.037121121A+1H0121687</p>	 <p><b>3540</b> kit tapón cierre alojamiento sensores r.o.357121140+032121142+N90316802</p>	 <p><b>3541</b> tapa de termostato 1.4-1.6(AEE) r.o.032121121B-J</p>
 <p><b>3542</b> brida en culata 1.7SDi-1.9SDi r.o.028121132A</p>	 <p><b>3592</b> kit completo de termostato, tapa y junta 1.0- <b>con termostato</b>, tapa y accesorios</p>	 <p><b>3615</b> cuerpo de termostato 1.0-1.4-1.6 completo <b>con termostato</b>, tapa y accesorios</p>
 <p><b>3590</b> tapa de termostato 1.9 TDi-SDi <b>desde '00</b> r.o.</p>	 <p><b>3591</b> tapa en culata (lateral) 1.9TDi-SDi <b>desde '00</b> r.o.</p>	 <p><b>2669</b> junta válvula desvaporizadora r.o.028103500</p>
 <p><b>3084</b> tubo de agua metálico 1.6(1F)-1.9 Diesel (1Y) r.o.037121065K/L/G/H</p>	 <p><b>3094</b> tubo de agua metálico 1.7SDi-1.9SDi r.o.028121065K/T</p>	 <p><b>3186</b> tubo de agua metálico 1.9TDi-SDi desde '00 r.o.</p>
 <p><b>3625</b> tubo de agua (plástico) con juntas tóricas 1.4-1.6(AEE), r.o.</p>	 <p><b>3644</b> tubo desvaporizador 1.9TDi-SDi r.o.028103491J</p>	 <p><b>3667</b> boquilla salida termostato completo r.o.</p>
 <p><b>3719</b> válvula desvaporizadora 1.9TDi-SDi r.o.028129101D</p>	 <p><b>3504</b> botella de expansión r.o.1H0121407A</p>	 <p><b>3506</b> tapón botella de expansión r.o.1H0121321A</p>



CANALIZACIONES de AIRE de ALTA PRESION INTERCOOLER-TURBO:

CADDY

1.9 Diesel motores TDi desde 11/'95 a 9/'00  
(AHU-1Z-AFN-ALE)

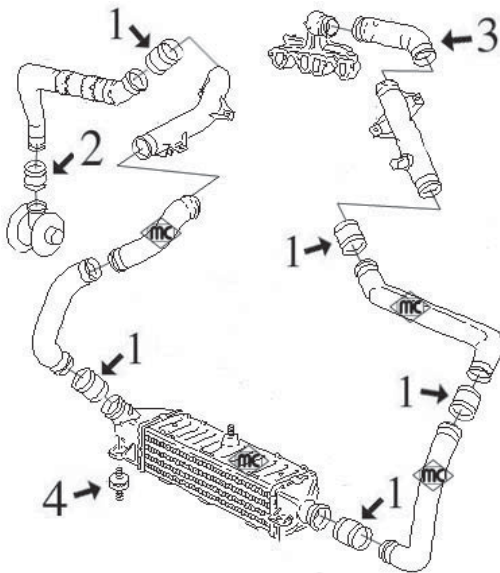

- 1- 9061 tubo flexible de empalme
- 2- 9062 tubo flexible de empalme
- 3- 9060 tubo flexible de colector de aspiración a tubo
- 4- n/d soporte elástico intercooler

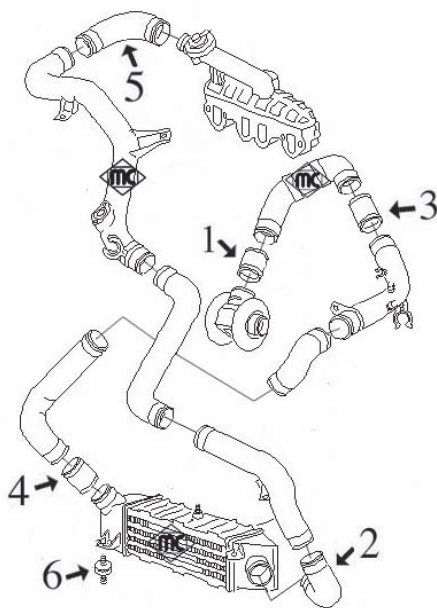

CADDY

1.9 Diesel motor TDi desde 9/'00  
(ALH)



- 1- 9062 tubo flexible de empalme
- 2- 9063 tubo flexible a intercooler
- 3- 9061 tubo flexible de empalme
- 4- 9064 tubo flexible de empalme
- 5- 9065 tubo flexible de colector de aspiración a tubo rígido
- 6- n/d soporte elástico intercooler

## VOLKSWAGEN CADDY (1996-2004)

<p><b>¡Nuevo!</b></p>  <p><b>9060</b> tubo flexible de colector a tubo r.o. 1H0145838G</p>	<p><b>¡Nuevo!</b></p>  <p><b>9061</b>      <b>Ø 50x60 largo 58 mm</b> tubo flexible de alta presion de empalme r.o. 1H0145834E</p>	<p><b>¡Nuevo!</b></p>  <p><b>9062</b>      <b>Ø 35x45 largo 58 mm</b> tubo flexible de alta presion de empalme r.o. 3A0145972A</p>
<p><b>¡Nuevo!</b></p>  <p><b>9063</b> tubo flexible a intercooler r.o. 6K0145832C</p>	<p><b>¡Nuevo!</b></p>  <p><b>9064</b>      <b>Ø 60x70 largo 58 mm</b> tubo flexible de alta presion de empalme r.o. 1J0145834A</p>	<p><b>¡Nuevo!</b></p>  <p><b>9065</b> tubo flexible de colector a tubo rígido r.o. 6K0145838B</p>

### CANALIZACIONES de COMBUSTIBLE:

**CADDY 1.6-75 CV motor 1F (hasta 5/'97)**

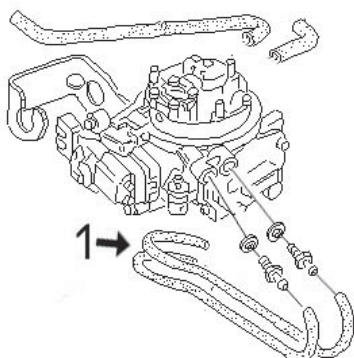

**1- 9062** juego de tubos entrada/salida gasolina a unidad de inyección

<p><b>¡Nuevo!</b></p>  <p><b>9146</b> jgo tubos entrada/salida gasolina a unidad de inyección, r.o. 6K0133699B+6K0133723B</p>		
--	--	--

SUSPENSION DELANTERA y SOPORTES DE MOTOR:

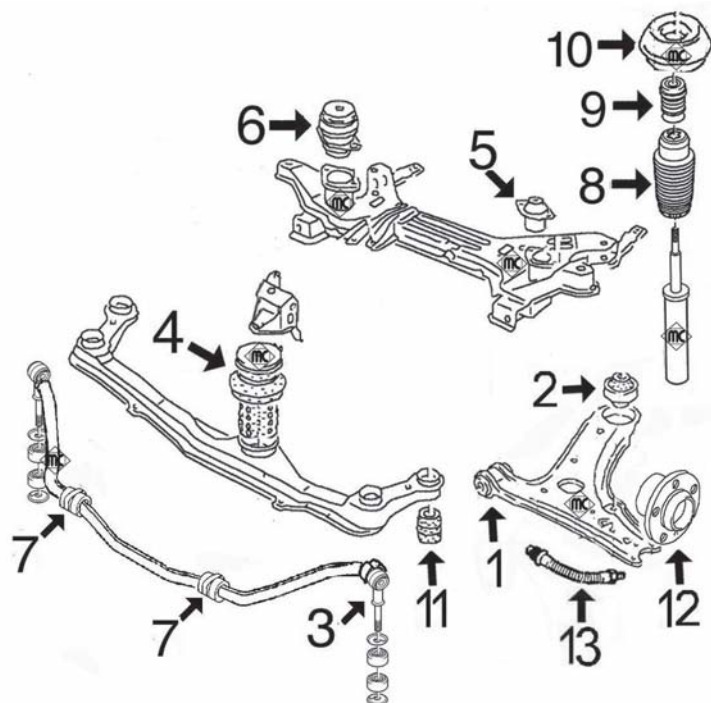

- 1- 542 silentbloc anterior trapecio delantero
- 2- 2660 silentbloc posterior trapecio delantero Golf-3
- 3- 2852 bieleta puntal barra estabilizadora
- 4- 2685 soporte motor delantero
- 5- 2627 soporte motor trasero izquierdo 1.4 y 1.6(AEE)  
4362 soporte motor trasero izquierdo 1.6(1F)-D y SDi
- 6- 2686 soporte motor trasero derecho
- 7- 917 goma para barra estabilizadora de Ø 18 mm  
4266 goma para barra estabilizadora de Ø 20 mm
- 8- 4324 capuchón amortiguador delantero
- 9- 4298 tope de amortiguador (poliuretano)
- 10- 2812 soporte amortiguador completo con rodamiento  
4128 rodamiento soporte amortiguador
- 11- 2444 silentbloc soporte travesa delantera
- 12- 90073 buje rueda delantera, freno sin ABS  
90035 buje rueda delantera, freno con ABS
- 13- 96124 latiguillo freno delantero (485 mm)



**542**  
silentbloc anterior trapecio delantero  
r.o. 191407182E

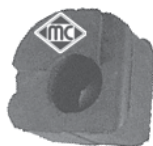

**917**  
goma para barra estabilizadora de Ø 18 mm  
r.o. 191411314



**2444**  
silentbloc sub-chasis delantero  
r.o. 1H0199233A



**2627**  
soporte motor trasero izquierdo 1.4-1.6(AEE)  
r.o. 191199381A



**2660**  
silentbloc posterior trapecio delantero  
(aluminio), r.o. 191407181E



**2685**  
soporte motor delantero  
r.o. 1H0199609E/F



**2686**  
soporte motor trasero derecho  
r.o. 1H0199262A/E/F

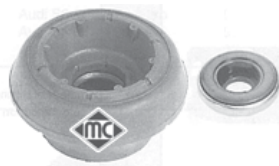

**2812**  
soporte amortiguador delantero completo  
con rodamiento, r.o. 357412331A

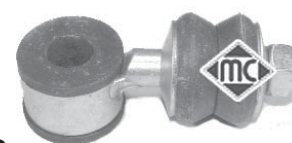

**2852**  
bieleta puntal barra estabilizadora  
r.o. 191411315A



**VOLKSWAGEN CADDY (1996-2004)**



**4128**

rodamiento soporte amortiguador delantero  
r.o. 1J0412249

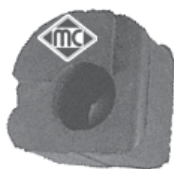

**4266**

goma para barra estabilizadora de Ø 20 mm  
r.o. 1H0411314



**4298**

tope poliuretano amortiguador delantero  
r.o. 1H0412303B



**4324**

capuchón amortiguador delantero  
r.o. 357413175A



**4362**

soporte motor trasero izquierdo D-SDi y 1.6  
(motor 1F), r.o. 3A0199402



**90073**

buje rueda delantera, freno sin ABS  
r.o. 357407615



**90035**

buje rueda delantera, freno con ABS  
r.o. 357407613B



**96124**











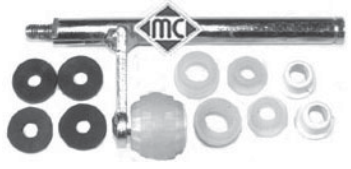







latiguillo freno delantero (485 mm)  
r.o. 1H0611701

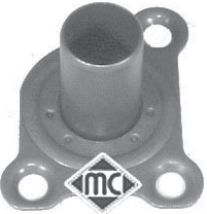

**96202**

latiguillo freno trasero (430 mm)  
r.o. 6K0611776

## VOLKSWAGEN CADDY (1996-2004)

<p><b>¡Nuevo!</b></p>  <p><b>3724</b> juego reparación rótula palanca de cambio r.o. 191711251A</p>	 <p><b>2841</b> juego reparación palanca de cambio r.o. 1H0711173+191711590A</p>	 <p><b>4361</b> guía soporte barra cambio r.o. 1H0711083</p>
 <p><b>2879</b>                      <b>largo 60 mm</b> bieleta selector de velocidades r.o. 1H0711595</p>	 <p><b>2878</b> varilla selector de velocidades r.o. 1H0711574</p>	<p><b>¡Nuevo!</b></p>  <p><b>4766</b> guía cerradura maneta puerta r.o. 1H0837223B</p>
 <p><b>4141</b> péndulo selector velocidades TDi hasta 9/'97 r.o. 1L0711051</p>	 <p><b>4360</b> péndulo selector velocidades TDi desde 9/'97, r.o. 1H0711051B</p>	<p><b>¡Nuevo!</b></p>  <p><b>3691</b> articulación cambio 1.9TDi r.o. 1J0711256</p>
<p><b>¡Nuevo!</b></p>  <p><b>4902</b> articulación cambio 1.4-1.6 hasta '99, r.o. 191711233</p>	 <p><b>2854</b> tope cable embrague r.o. 1H0798303A</p>	<p><b>¡Nuevo!</b></p>  <p><b>4749</b> guía embrague con retén 1.9TDi r.o. 02A141180A</p>
<p><b>¡Nuevo!</b></p>  <p><b>4903</b> guía embrague 1.4-1.6 r.o. 085141181</p>	<p><b>¡Nuevo!</b></p>  <p><b>4772</b> juego palanca de desembrague 1.6-1.9TDi-SDi-1.7SDi, r.o. 02K141709A+020141723C</p>	<p><b>¡Nuevo!</b></p>  <p><b>4906</b> varilla accionamiento embrague (341 mm) r.o. 020141741B</p>
 <p><b>1921</b> kit fuelle transmisión lado rueda homocinética de Ø 78 mm, r.o. 191498203C</p>	 <p><b>1297</b> kit fuelle transmisión lado rueda homocinética de Ø 86 mm, r.o. 1H0498203</p>	
 <p><b>1632</b> kit rep. transmisión l/cambio (Ø 21-89 mm), r.o. 171498201A</p>	 <p><b>1192</b> kit rep. transmisión lado cambio SDi, (Ø 27-100 mm), r.o. 191498202A</p>	<p><b>¡Nuevo!</b></p>  <p><b>1061</b> kit rep. transmisión l/cambio (Ø 27-89 mm), r.o.</p>

VOLKSWAGEN CADDY (1996-2004)



**1765**  
fuelle cremallera asistida  
r.o.175422831



**1765-C**  
kit reparación cremallera asistida  
r.o.



**864**  
cubrepedal freno y embrague  
r.o.321721173

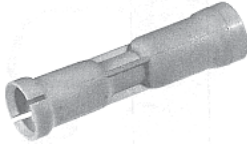

**2448**  
guia varilla nivel aceite 1.6 (motor 1F)  
r.o.053103663



**2876**  
guia varilla nivel aceite 1.9D-SDi hasta '99  
r.o.028103663B



**4355**  
guia varilla nivel aceite 1.4-1.6 (motor AEE)  
r.o. 030115636A



**3571**  
guia varilla nivel aceite SDi desde '99  
r.o.038103663



**4793**  
varilla nivel aceite 1.4-16  
r.o.



**4759**  
varilla nivel aceite 1.9TDi-SDi desde '00  
r.o.



**4760**  
varilla nivel aceite 1.6-75CV (1F, hasta '97)  
r.o.027115611C



**4942**  
varilla nivel aceite 1.9TDi-SDi hasta '00  
r.o.028115611C

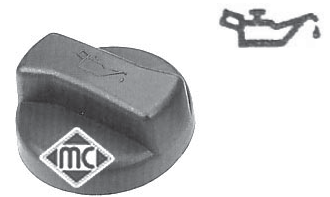

**3621**  
tapón llenado aceite motor  
r.o.026103485



**3681**  
cubierta correa distribución 1.6-75CV (1F)  
r.o.026109173A



**3715**  
cubierta correa distribución 1.6-75CV (1F)  
r.o.026109107B



**3718**  
tubo entrada aire a caudalímetro 1.9TDi  
r.o.6K0129684F



**4290**  
polea cigueñal 1.9TDi-1.7SDi hasta '03 y  
1.9SDi hasta '01, r.o.028105243T



**4421**  
polea cigueñal 1.9SDi desde '01 hasta '03  
r.o.038105243



**4480**  
polea cigueñal 1.9SDi desde '03  
r.o.03G105243

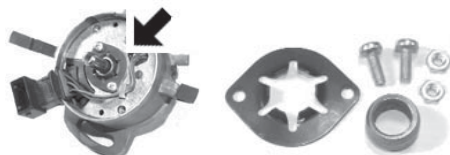

**4296**  
kit reparación distribuidor Magneti-Marelli  
1.4-1.6 (casquillo sinterizado del eje rotor)



**3672**  
válvula filtro gasoil  
r.o.191127247A



**2695**  
soporte carburador 1.6 motor 1F  
r.o.050129761H

## VOLKSWAGEN CADDY (1996-2004)

<p><b>¡Nuevo!</b></p>  <p><b>4768</b> rodillo tensor correa alternador 1.6-75CV, 1.9SDi-TDi hasta '00 y 1.7SDi r.o. 028145278E</p> <p style="text-align: right;"><b>Ø 78 mm</b></p>	<p><b>¡Nuevo!</b></p>  <p><b>4767</b> rodillo tensor correa alternador 1.9TDi des- de '00, r.o. 038145276</p> <p style="text-align: right;"><b>Ø 65 mm</b></p>	<p><b>¡Nuevo!</b></p>  <p><b>4770</b> tensor correa alternador 1.4-1.6 r.o. 030145299F</p>
<p><b>¡Nuevo!</b></p>  <p><b>4771</b> rodillo tensor correa alternador 1.9D (AEF) desde '97, r.o. 028145278M</p>	<p><b>¡Nuevo!</b></p>  <p><b>4908</b> tensor correa alternador 1.9D-TDi hasta '97 r.o. 028903315R</p>	<p><b>¡Nuevo!</b></p>  <p><b>4923</b> tensor correa alternador 1.9TDi desde '97 r.o. 028903315P</p>
<p><b>¡Nuevo!</b></p>  <p><b>4909</b> tensor correa alternador 1.6 gasolina (1F) r.o. 037903315C</p>	<p><b>¡Nuevo!</b></p>  <p><b>4944</b> tensor correa alternador 1.9TDi desde '02 r.o. 038903315C</p>	<p><b>¡Nuevo!</b></p>  <p><b>5039</b> tensor correa alternador 1.9SDi r.o. 038903315K</p>
<p><b>¡Nuevo!</b></p>  <p><b>4919</b>      <b>Ø 55/50 mm, H=40,5 mm</b> polea de alternador de rueda libre r.o. 028903119AA</p>	<p><b>¡Nuevo!</b></p>  <p><b>4997</b>      <b>Ø 61/55 mm, H=41 mm</b> polea de alternador de rueda libre r.o. 022903119A</p>	
 <p><b>4364</b> soporte catalizador r.o. 1H0253144E</p>	 <p><b>2426</b> soporte presilenciador r.o. 1H0253147B</p>	 <p><b>2425</b> soporte trasero escape r.o. 1H0253144C</p>
 <p><b>2780</b> junta de colector escape a culata D-SDi r.o. 028129589B</p>	 <p><b>2845</b> soporte superior radiador r.o. 6K0121267</p>	 <p><b>4365</b> jgo. tornillo sujeción tapa cubremotor r.o. 028103665+028103937+028103638G</p>
 <p><b>792</b> tuerca rueda r.o. 3A0601139</p>	 <p><b>674</b> tapón cárter de aceite hasta '98 r.o. 113115193</p>	 <p><b>2916</b> tapón cárter de aceite desde '98 r.o. N90813201</p>



VOLKSWAGEN GOLF - 1 (1975-1984)



**3574**  
tapón botella de expansión  
r.o.443121321



**3536**  
tapa de termostato  
r.o.055121321F



**722**  
soporte motor inferior  
r.o.171399151B

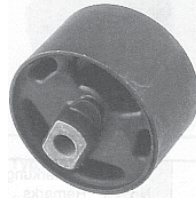

**723**  
soporte motor derecho (Ø 74.6 mm)  
r.o.171199214G/K/F



**2696**  
soporte carburador  
r.o.050129761E



**2880**  
soporte carburador  
r.o.026129761E



**1359**  
kit fuelle transmisión lado rueda  
r.o.321407285B



**1455**  
kit fuelle transmisión lado cambio  
r.o.171498201

**¡Nuevo!**

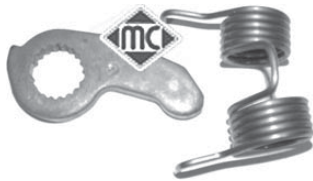

**4772**  
juego palanca desembrague (5 velocds.)  
r.o.020141709B

**¡Nuevo!**



**4906**  
varilla empuje embrague (5 velc., 341 mm)  
r.o.020141741B



**238**  
soporte tubo de escape  
r.o.823253149



**366**  
soporte tubo de escape  
r.o.



**674**  
tapón cárter de aceite  
r.o.



**90516**  
mangueta rueda trasera  
r.o.357501117



**2609**  
tuerca junta homocinética  
r.o.171407643A



**96109**  
latiguillo freno delantero (343 mm)  
r.o.



**96111**  
latiguillo freno trasero (racores hembra/  
hembra, 195 mm), r.o.



**96175**  
latiguillo freno trasero (racores hembra/  
macho, 190 mm)

## VOLKSWAGEN GOLF - 2 (1984-1991)

### CANALIZACIONES DE AGUA:

**GOLF - 2**

**1.6 carburador (EZ-RF-PN-ABN)  
1.8 carburador (GU-RH)**

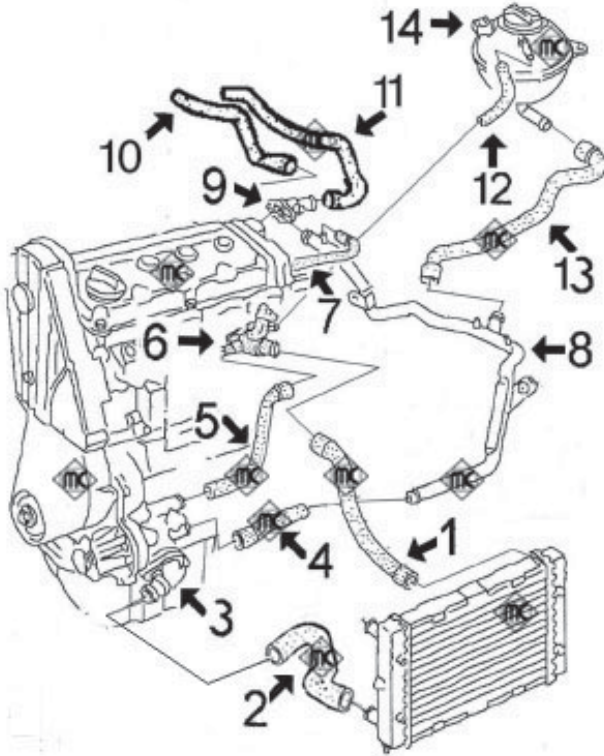

- 1- 7366 mgto superior radiador 1.6 sin aire acondicionado
- 7342 mgto superior radiador 1.8 sin aire acondicionado
- 7340 mgto superior radiador 1.6-1.8 con aire acondic.
- 2- 7367 mgto inferior radiador 1.6 sin aire acondicionado
- 7343 mgto inferior radiador 1.8 sin aire acondicionado
- 7341 mgto inferior radiador 1.6-1.8 aire acondicionado
- 3- 3536 tapa de termostato
- 4- 7993 mgto de bomba a tubo metálico
- 5- 7715 mgto de bomba a tapa plástico en culata
- 6- 3535 tapa de agua conexión mgto
- 7- 8381 juego mgto de tubo metálico a colector
- 8- 3079 tubo de agua metálico
- 9- 3517 boquilla plástico en culata
- 10- 8051 mgto de tubo metálico a calefactor
- 11- 7918 mgto de culata a calefactor
- 12- 116 mgto de sobrante de botella a radiador: Cortar de rolo MC-116 Ø 8x14 mm, long. aprox 610 m
- 13- 7992 mgto de tubo metálico a botella hasta '90
- 8378 mgto de tubo metálico a botella desde '90
- 14- 3520 botella de expansión hasta '90 con agujero para sensor de nivel
- 3504 botella de expansión desde '90
- 3574 tapón botella de expansión hasta '90
- 3506 tapón botella de expansión desde '90
  
- 8225 mgto desvaporizador 1.6-1.8
- 8227 mgto desvaporizador 1.6-1.8

**GOLF - 2**

**1.8 inyección "GTi" (motores de 8 válvulas PB-RP-PF-RV)**

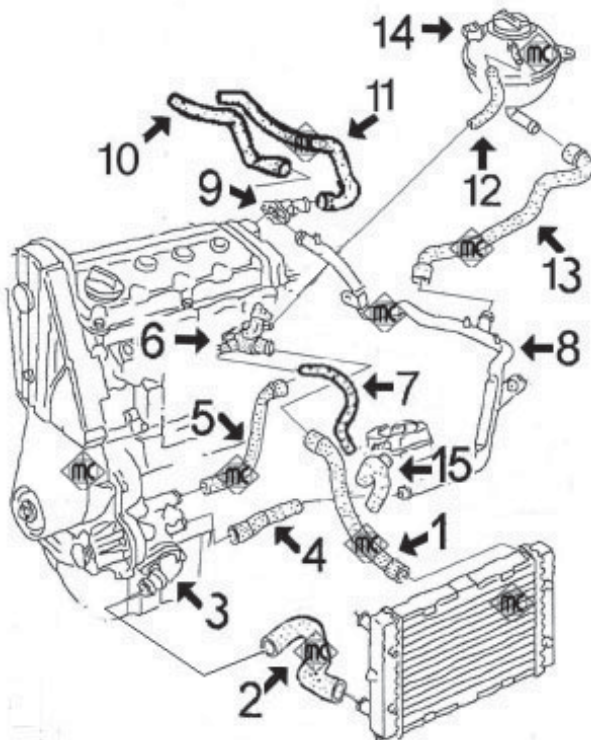

- 1- 7342 mgto superior radiador sin aire acondicionado
- 7340 mgto superior radiador con aire acondic.
- 2- 7343 mgto inferior radiador sin aire acondicionado
- 7341 mgto inferior radiador con aire acondicionado
- 3- 3536 tapa de termostato
- 4- 7993 mgto de bomba a tubo metálico
- 5- 7715 mgto de bomba a tapa plástico en culata
- 6- 3505 tapa de agua conexión mgto
- 7- 8193 mgto de intercambiador a tapa en culata
- 8- 3083 tubo de agua metálico
- 9- 3517 boquilla plástico en culata
- 10- 8051 mgto de tubo metálico a calefactor
- 11- 7918 mgto de culata a calefactor
- 12- 116 mgto de sobrante de botella a radiador: Cortar de rolo MC-116 Ø 8x14 mm, long. aprox 610 m
- 13- 7992 mgto de tubo metálico a botella hasta '90
- 8378 mgto de tubo metálico a botella desde '90
- 14- 3520 botella de expansión hasta '90 con agujero para sensor de nivel
- 3504 botella de expansión desde '90
- 3574 tapón botella de expansión hasta '90
- 3506 tapón botella de expansión desde '90
- 15- 7994 mgto de intercambiador a tubo metálico
  
- 8225 mgto desvaporizador 1.8
- 8227 mgto desvaporizador 1.8

## VOLKSWAGEN GOLF - 2 (1984-1991)

**GOLF - 2**

**1.8-16v. (motores de 16 válvulas KR-PL)  
1.8 "G60" (motor PG)**

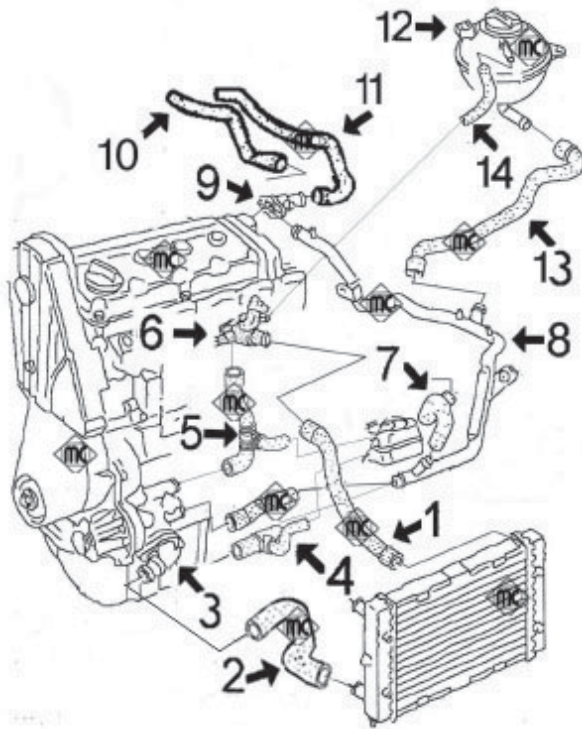

- 1- 8194 mgto superior radiador 1.8-16v. sin aire acond.  
7340 mgto superior radiador 1.8-16v. con aire acond.  
n/d mgto superior radiador G60
- 2- 7367 mgto inferior radiador 1.8-16v. sin aire acond.  
7341 mgto inferior radiador 1.8-16v. con aire acond.  
n/d mgto inferior radiador G60
- 3- 3536 tapa de termostato
- 4- 7993 mgto de bomba a tubo metálico 1.8-16v.  
7922 mgto de bomba a intercambiador G60
- 5- 7920 mgto de bomba a tapa en culata
- 6- 3582 tapa de agua conexión mgts. 1.8-16v.  
3535 tapa de agua conexión mgts. G60
- 7- 7994 mgto de intercambiador a tubo metálico
- 8- n/d tubo de agua metálico
- 9- 3517 boquilla plástico en culata
- 10- 8051 mgto de tubo metálico a calefactor
- 11- 8050 mgto de culata a calefactor
- 12- 3520 botella de expansión hasta '90 con agujero para sensor de nivel  
3504 botella de expansión desde '90  
3574 tapón botella de expansión hasta '90  
3506 tapón botella de expansión desde '90
- 13- 7992 mgto de tubo metálico a botella hasta '90  
8378 mgto de tubo metálico a botella desde '90
- 14- 116 mgto de sobrante de botella a radiador: Cortar de rollo MC-116 Ø 8x14 mm, long. aprox 610 m

**GOLF - 2**

**1.6 Diesel (motores JP-ME-1V)  
1.6 TurboDiesel (motores JR-MF-RA-SB)**

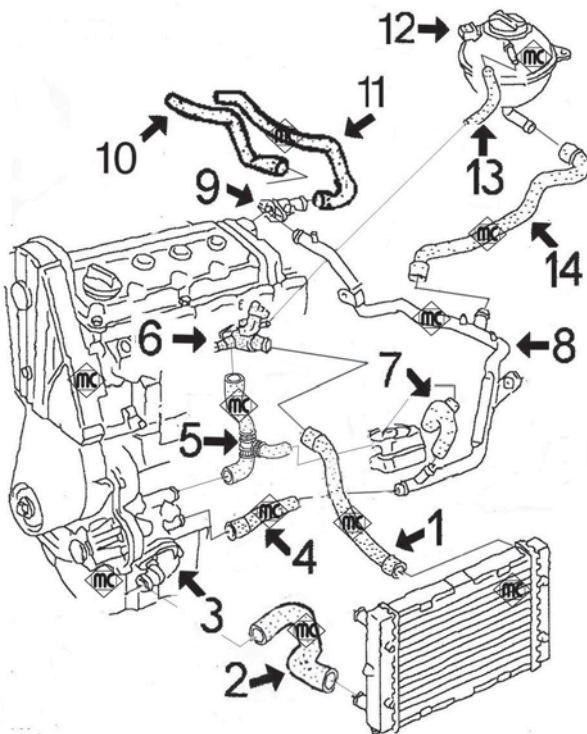

- 1- 7342 mgto superior radiador sin aire acondicionado  
7340 mgto superior radiador con aire acondicionado
  - 2- 7343 mgto inferior radiador sin aire acondicionado  
7341 mgto inferior radiador con aire acondicionado
  - 3- 3536 tapa de termostato
  - 4- 7993 mgto de bomba a tubo metálico
  - 5- 7987 mgto de bomba a tapa plástico en culata
  - 6- 3527 tapa de agua conexión mgts
  - 7- 7994 mgto de intercambiador a tubo metálico
  - 8- 3083 tubo de agua metálico
  - 9- 3517 boquilla plástico en culata
  - 10- 8051 mgto de tubo metálico a calefactor
  - 11- 8050 mgto de culata a calefactor
  - 12- 3520 botella de expansión hasta '90 con agujero para sensor de nivel  
3504 botella de expansión desde '90  
3574 tapón botella de expansión hasta '90  
3506 tapón botella de expansión desde '90
  - 13- 116 mgto de sobrante de botella a radiador: Cortar de rollo MC-116 Ø 8x14 mm, long. aprox 610 m
  - 14- 7992 mgto de tubo metálico a botella hasta '90  
8378 mgto de tubo metálico a botella desde '90
- 8385 mgto desvaporizador



## VOLKSWAGEN GOLF - 2 (1984-1991)



**7340**  
mgto superior radiador Diesel y TurboD  
r.o. 191121101B/Q



**7341**  
mgto inf. radiador Diesel y TurboD todos  
y 1.8-16v. con aire ac., r.o. 191121051G/P



**7342**  
mgto superior radiador 1.8 GTI (no 16v.)  
r.o. 191121101S



**7343**  
mgto inferior radiador 1.8 GTI (no 16v.)  
r.o. 191121051F



**7366**  
mgto superior radiador 1.6  
r.o. 191121101A



**7367**  
mgto inferior radiador 1.6 todos y 1.8-16v  
con aire acondicionado, r.o. 191121051E



**7715**  
mgto de bomba a culata 1.6-1.8  
r.o. 026121053G



**7918**  
mgto de calefactor a culata 1.6-1.8  
r.o. 191819371F

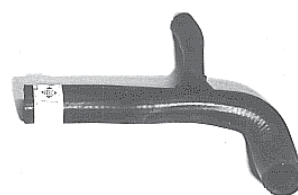

**7920**  
mgto de bomba a culata 1.8-16 v.  
r.o. 027121053B



**7922**  
mgto de bomba a tubo metálico Golf G-60  
r.o. 068121058C



**7987**  
mgto de bomba a culata 1.6 D-TD  
r.o. 068121053P



**7992**  
mgto de tubo metálico a botella  
r.o. 191121109E



**7993**  
mgto de bomba de agua a tubo metálico  
r.o. 068121063M



**7994**  
mgto de tubo metálico a intercambiador  
r.o. 037121058A



**8050**  
mgto de calefactor a culata D-TD y 16v.  
r.o. 191819371H



**8051**  
mgto de calefactor a tubo metálico  
r.o. 191819373D



**8193**  
mgto de intercambiador a culata 1.8 GTI  
r.o. 027121096A



**8194**  
mgto superior radiador 1.8-16v.  
r.o. 191121101AC













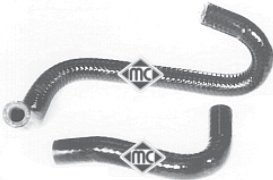







**8225**  
mgto desvaporizador 1.8 sin catalizador  
r.o. 051103493



**8227**  
mgto desvaporizador 1.6 sin catalizador  
r.o. 026103493A



## VOLKSWAGEN GOLF - 2 (1984-1991)

 <p><b>8378</b> mgto de tubo metálico a botella expansión r.o.535121109-1H0121109-1H0121109A</p>	 <p><b>8381</b> juego mgto de colector 1.6 r.o.026121062C+037121057</p>	 <p><b>8385</b> mgto desvaporizador Diesel y TurboD r.o.028103493E</p>
 <p><b>2669</b> junta válvula desvaporizadora r.o.028103500</p>	 <p><b>8377</b> mgto depresor servofreno todos mods. r.o.321611939E</p>	
 <p><b>3079</b> tubo de agua metálico 1.6 r.o.027121065C</p>	 <p><b>3083</b> tubo de agua metálico 1.8 y Diesel h/93 r.o.027121065D/E-028121065A</p>	 <p><b>3087</b> tubo metálico de agua 1.05-1.3 r.o.052121071Q</p>
 <p><b>3504</b> botella de expansión con sensor de nivel, todos desde '90, r.o. 1H0121407A</p>	 <p><b>3505</b> tapa de agua en culata 1.8 GTI r.o.037121133C-037121133B</p>	 <p><b>3506</b> tapón botella de expansión desde '90 r.o.1H0121321A</p>
 <p><b>3517</b> boquilla en culata conexión mgto calefac. r.o.037121145</p>	 <p><b>3520</b> botella de expansión Golf-2 hasta '90 (para sensor de nivel), r.o. 171121407F</p>	 <p><b>3521</b> tapa de agua en culata D y TD r.o.068121132-068121133AB/AE</p>
 <p><b>3528</b> tapa de termostato 1.05-1.3 r.o.055121121F</p>	 <p><b>3535</b> tapa de agua en culata 1.6-1.8 r.o.037121133B-037121132B</p>	 <p><b>3536</b> tapa de termostato 1.6-1.8-D-TD r.o.055121121F</p>
 <p><b>3543</b> brida de agua conexión mgto 1.05-1.3 r.o.030121117L-M</p>	 <p><b>3574</b> tapón botella de expansión hasta '90 r.o.443121321</p>	 <p><b>3582</b> tapa de agua en culata (frontal) 1.8-16v. r.o.027121133E</p>

SUSPENSION DELANTERA y SOPORTES DE MOTOR:

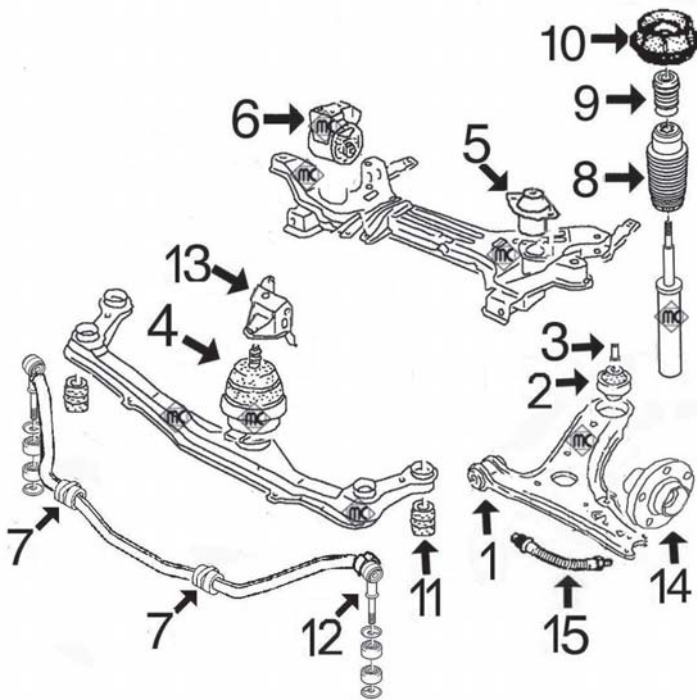

- 1- 542 silentbloc anterior trapecio delantero
- 2- 543 silentbloc posterior trapecio delantero
- 3- 2822 casquillo eje silentbloc posterior
- 4- 848 soporte motor delantero 1.6 D-TD
- 849 soporte motor delantero 1.6/1.8 gasolina
- 5- 2627 soporte motor trasero izquierdo 1.05-1.3
- 846 soporte motor trasero izquierdo 1.6-1.8
- 987 soporte motor trasero izquierdo 1.6 Diesel y TD
- 6- 847 soporte motor trasero derecho salvo 16v. ni G60
- 4127 soporte motor trasero derecho 16v. y G60
- 7- 917 goma para barra estabilizadora de Ø 18 mm
- 4266 goma para barra estabilizadora de Ø 20 mm
- 8- n/d capuchón amortiguador delantero
- 9- 712 tampón de amortiguador
- 10- 896 soporte amortiguador delantero
- 11- 2444 silentbloc soporte travesía delantera
- 12- 646 bieleta barra estabilizadora
- 2482 anillo de goma en bieleta barra estabilizadora
- 13- 4129 anclaje metálico del soporte motor delantero
- 14- 90008 buje rueda delantera hasta '88
- 90073 buje rueda delantera sin ABS desde '88
- 90035 buje rueda delantera con ABS
- 15- 96109 latiguillo freno delantero (310 mm)

SUSPENSION TRASERA

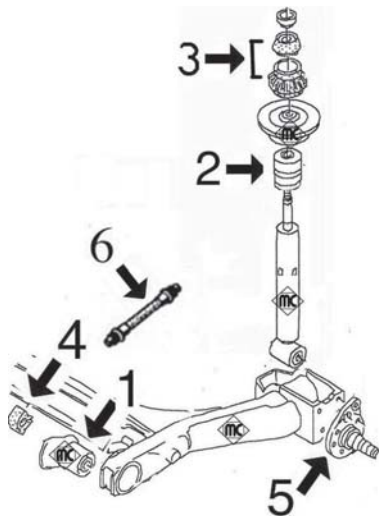

- 1- 924 silentbloc brazo trasero suspensión
- 2- 2811 tope poliuretano amortiguador trasero
- 3- 4320 juego soportes amortiguador
- 4- 2824 goma barra estabilizadora
- 5- 90516 mangueta rueda trasera, freno de tambor sin ABS
- 90539 mangueta rueda trasera izquierda, tambor con ABS
- 90540 mangueta rueda trasera derecha, tambor con ABS
- 90541 mangueta rueda trasera izquierda, freno de disco
- 90542 mangueta rueda trasera derecha, freno de disco
- 6- 96111 latiguillo freno trasero (racores hembra-hembra) longitud 160 mm
- 96175 latiguillo freno trasero (racores hembra-macho) longitud 190 mm



**542**  
silentbloc anterior trapecio delantero  
r.o. 191407182E



**543**  
silentbloc posterior trapecio delantero  
r.o. 191407181A



**2822**  
casquillo eje silentbloc posterior trapecio delantero, r.o. 191407190A



**712**  
tope de goma amortiguador delantero  
r.o. 191412303A



**646**  
bieleta puntal barra estabilizadora  
r.o. 191411315



**917**  
goma para barra estabiliz. de Ø 18 mm  
r.o. 191411314

## VOLKSWAGEN GOLF - 2 (1984-1991)



**896**  
soporte amortiguador delantero completo  
con rodamiento, r.o. 191412329



**2444**  
silentbloc traviesaño subchasis delantero  
r.o. 191199233

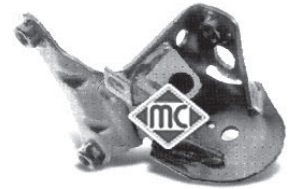

**4129**  
anclaje metálico del soporte motor delt.  
r.o. 191199273C

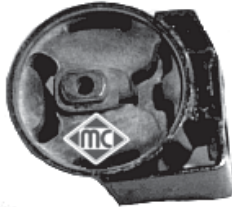

**847**  
soporte motor trasero derecho  
r.o. 191199262A



**848**  
soporte motor delantero Diesel  
hidráulico, r.o. 191199279C



**849**  
soporte motor delantero gasolina  
r.o. 191199279E



**846** vaso de Ø 64 mm  
soporte de motor izquierdo (hidráulico)  
r.o. 191199402



**987** vaso de Ø 73 mm  
soporte de motor izquierdo (hidráulico)  
r.o. 191199402A



**2627**  
soporte de motor izquierdo 1.05-1.3  
r.o. 191199381A



**4127**  
soporte motor trasero derecho 16v. y G60  
(hidráulico), r.o. 535199262



**2811**  
tampón amortiguador trasero  
r.o. 191512131B

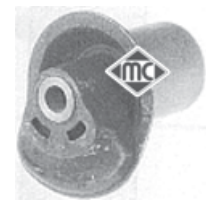

**924**  
silentbloc brazo trasero (Ø 44 mm)  
r.o. 191501541



**4320**  
jgo soportes fijación amortiguador trasero  
r.o. 191512333+191512335

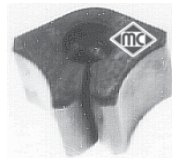

**2824**  
goma barra estabilizadora trasera  
r.o. 871511423

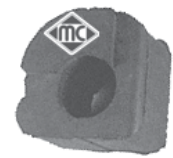

**4266**  
goma para barra estabilizadora de Ø 20 mm  
r.o. 1H0411314



**90008**  
bujes rueda delantera hasta '88  
(Ø 122 mm), r.o. 191407615



**90073**  
bujes rueda delantera sin ABS desde '88  
(Ø 120 mm), r.o. 357407615



**90035**  
bujes rueda delantera con ABS  
(Ø 120 mm), r.o. 357407613B



**90516**  
mangueta rueda trasera freno tambor  
sin ABS, r.o. 357501117



**90539**  
mangueta rueda trasera izquierda, tambor  
con ABS, r.o. 333501117A



**90540**  
mangueta rueda trasera derecha, tambor  
con ABS, r.o. 333501118A



VOLKSWAGEN GOLF - 2 (1984-1991)



**90541**  
mangueta rueda trasera **izquierda**, freno de disco, r.o. 333501117



**90542**  
mangueta rueda trasera **derecha**, freno de disco, r.o. 333501118



**96109**  
latiguillo freno delantero (310 mm) r.o. 171611701g



**96111**  
latiguillo freno trasero (racores hembra/hembra, 160mm), r.o. 171611775A



**96175**  
latiguillo freno trasero (racores hembra/macho, 190mm), r.o. 481611775



**947** **largo 74 mm**  
bieleta selector de velocidades r.o. 191711595A



**2840**  
juego reparación palanca de cambio r.o. 191711173B+171711067B



**4184**  
guía-soporte barra cambio r.o. 191711083



**4024**  
palanca de cambio r.o. 191711116C



**3724**  
rótula base palanca de cambio r.o. 191711251A



**2813**  
varilla selector de velocidades r.o. 191711574



**4902**  
articulación cambio 1.05-1.6-1.65 velocd. r.o. 191711233



**4772**  
juego palanca desembrague 5 velcds. r.o. 020141709B



**4906**  
varilla desembrague 5 velcds. (341 mm) r.o. 020141741B



**4749**  
casquillo guía embrague con retén 1.8 r.o. 02A141180A

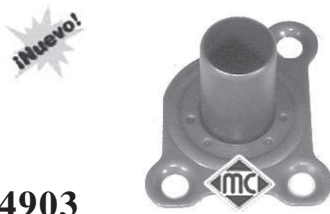

**4903**  
casquillo guía embrague 1.05-1.3 r.o. 085141181



**2854**  
tope punta cable embrague r.o. 1H0798303A



**3681**  
cubierta correa distribución 1.6-1.8 r.o. 026109173A



**3687**  
cubierta correa distribución 1.6 r.o. 26109175A

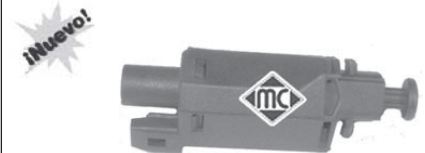

**3739**  
interruptor luz de frenada (2 polos) r.o. 191945515-191945515A/B



VOLKSWAGEN GOLF - 2 (1984-1991)



**1359** **1359-E**  
kit rep. transmisión l/rueda 1.6 y Diesel  
hasta '92, r.o. 321407285B



**1575**  
kit rep. transmisión l/rueda 1.8-2.0.TD  
r.o. 431407285B

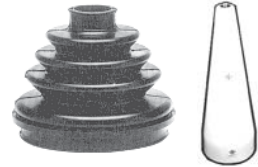

**1575-E** **para montar con cono**  
kit rep. transmisión l/rueda 1.8-2.0.TD  
r.o. 431407285B



**1632**  
kit rep. transmisión l/cambio 1.3-1.6  
r.o. 171498201A



**1560**  
kit rep. transmisión **izquierda** l/cambio  
1.8-TD, r.o. 321407283A



**1637**  
kit rep. transmisión dcha. l/cambio  
1.8-2.0-TD-TDi hasta '94, r.o. 191407283



**1511**  
fuelle cremallera manual  
r.o. 191419831



**1765**  
fuelle cremallera asistida  
r.o. 175422831



**1765-C**  
kit reparación cremallera asistida  
r.o.

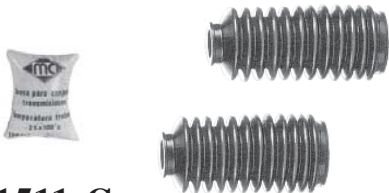

**1511-C**  
kit reparación cremallera manual  
r.o.



**2301**  
casquillo cremallera manual  
r.o. no hay despiece



**4766**  
guía cremallera maneta puerta  
r.o. 1H0837223B



**2699**  
soporte carburador 1.05 (AAV)  
r.o. 030129765G



**2696**  
soporte carburador Golf-2 1.6 (HM-HN-HV)  
r.o. 050129761E



**2815**  
soporte carburador Golf-2 1.05 (HK) y  
1.3 (MH-2G), r.o. 052129765E



**2880**  
soporte carburador Golf-2 1.6-1.8 (EZ-GU  
RF-RH), r.o. 026129761E



**2695**  
soporte carburador Golf-2 1.8 (RP) y Golf-  
3 1.8, r.o. 050129761F/B

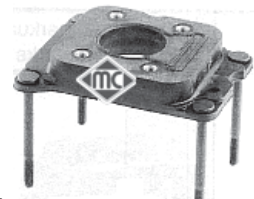

**2855**  
soporte carburador Golf-3 1.6  
r.o. 032129765



**3688**  
guía varilla nivel aceite 1.05-1.3-1.6  
r.o. 036115636

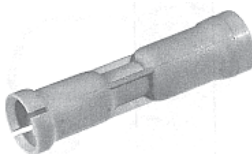

**2448**  
guía varilla nivel aceite (gasolina)  
r.o. 053103663



**2876**  
guía varilla nivel aceite (Diesel)  
r.o. 028103663B

## VOLKSWAGEN GOLF - 2 (1984-1991)

<p><b>¡Nuevo!</b></p>  <p><b>4760</b> varilla nivel aceite 1.6-1.8 r.o.027115611C</p>	 <p><b>2779</b> kit sujeción escape a colector Golf-2 1.6 r.o.161298115</p>	 <p><b>2780</b> junta de colector 1.05-1.3-1.6-1.8-D r.o.028129589B</p>
 <p><b>098</b> soporte tubo de escape r.o.191253147</p>	 <p><b>238</b> soporte tubo de escape r.o.823253149</p>	  <p><b>3621</b> tapón llenado aceite motor r.o.026103485</p>
 <p><b>792</b> tuerca rueda r.o.3A0601139</p>	 <p><b>674</b> tapón cárter de aceite 14x150 r.o.113115193</p>	 <p><b>864</b> cubrepedal freno y embrague r.o.321721173</p>
<p><b>¡Nuevo!</b></p>  <p><b>3708</b> tapón llenado combustible (sin llave) r.o.1j0201553C</p>		

## VOLKSWAGEN GOLF - 3 (1992-1998)

### CANALIZACIONES DE AGUA:

**GOLF - 3**      1.4 motor ABD (hasta '7/95)  
 1.6 motor ABU (hasta '7/94)

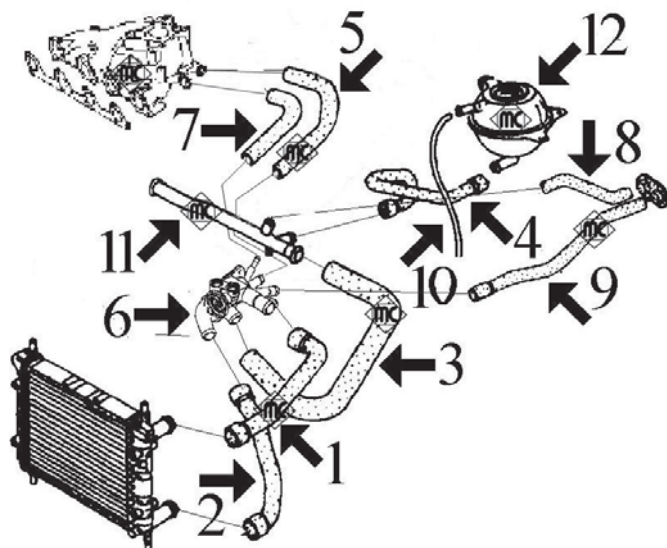

- 1- 8418 mgto superior radiador
- 2- 8416 mgto inferior radiador
- 3- 8409 mgto de racor a tubo rígido
- 4- 8378 mgto de tubo rígido a botella expansión
- 5- 7968 mgto de tubo rígido a colector
- 6- 3528 tapa de termostato  
3543 caja de termostato
- 7- 8411 mgto de tubo rígido a colector 1.4  
n/d mgto de tubo rígido a colector 1.6
- 8- 8397 mgto derecho de calefactor a tubo rígido
- 9- 8393 mgto izquierdo de calefactor a a racor
- 10- 116 mgto de botella a radiador: Cortar de rollo MC-116 Ø 8x14 mm, long. aprox 460 mm
- 11- 3618 tubo de agua (plástico) con junta tórica
- 12- 3504 botella de expansión  
3506 tapón botella de expansión

8415 mgto desvaporizador

**GOLF - 3**      1.6 motor AEA (desde '7/94 hasta '7/95)

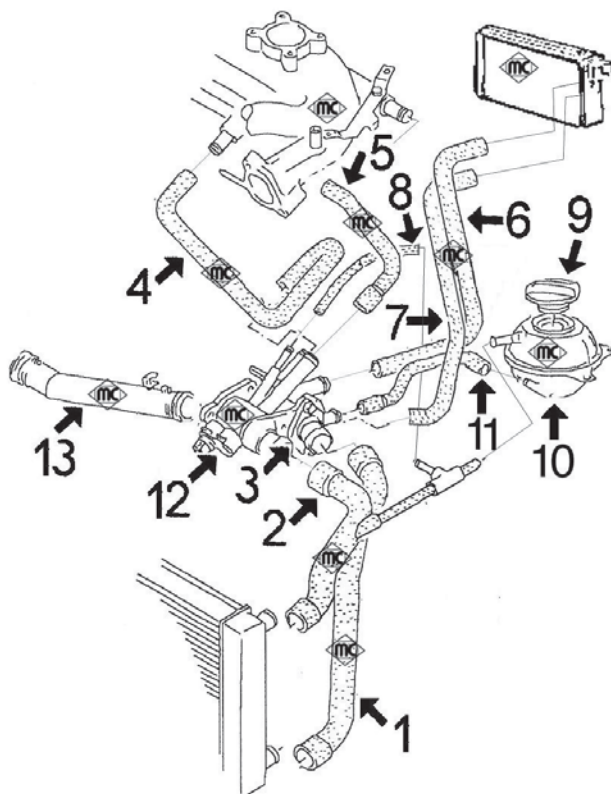

- 1- 8825 mgto inferior radiador
- 2- 8823 mgto superior radiador
- 3- 3588 tapa de termostato
- 4- 8801 mgto de cuerpo termostato a culata
- 5- 8799 mgto de cuerpo termostato a colector
- 6- 8821 mgto entrada agua a calefactor (con toma para sensor)
- 7- 8824 mgto retorno agua de calefactor
- 8- 116 mgto sobrante de botella a termostato: cortar de rollo MC-116 Ø 8x14 mm, long. aprox. 350 mm
- 9- 3506 tapón botella expansión
- 10- 3504 botella expansión
- 11- 8822 mgto de cuerpo termostato a botella
- 12- n/d cuerpo de termostato
- 13- 3625 tubo de agua (plástico) con juntas tóricas

8812 mgto desvaporizador

## VOLKSWAGEN GOLF - 3 (1992-1998)

**GOLF - 3**      1.4 motor AEX (desde '7/95)  
 1.6 motor AEE (desde '7/95)

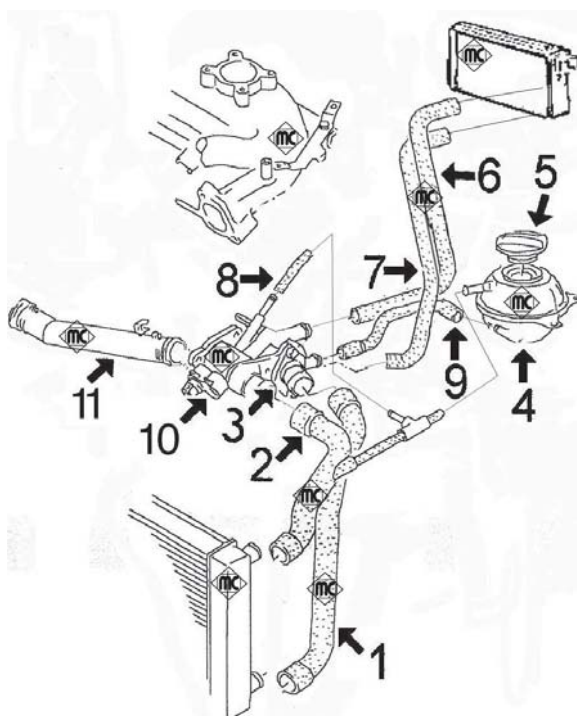

- 1- 8825 mgto inferior radiador
- 2- 8823 mgto superior radiador (3 vias)
- 3- 3592 kit de termostato completo con tapa y junta  
3541 tapa de termostato
- 4- 3504 botella de expansión
- 5- 3506 tapón botella de expansión
- 6- 8847 mgto entrada agua a calefactor
- 7- 8846 mgto retorno agua de calefactor
- 8- 116 mgto sobrante de botella a mgto inferior y caja de termostato: cortar de rollo MC-116 Ø 8x14 mm, long. aprox. 350 mm
- 9- 8822 mgto de cuerpo termostato a botella
- 10- 3615 cuerpo de termostato completo con termostato, tapa y accesorios
- 11- 3625 tubo de agua (plástico) con juntas tóricas

8811 mgto desvaporizador

**GOLF - 3**      1.8 motores AAM-ABS-ADZ-ACC

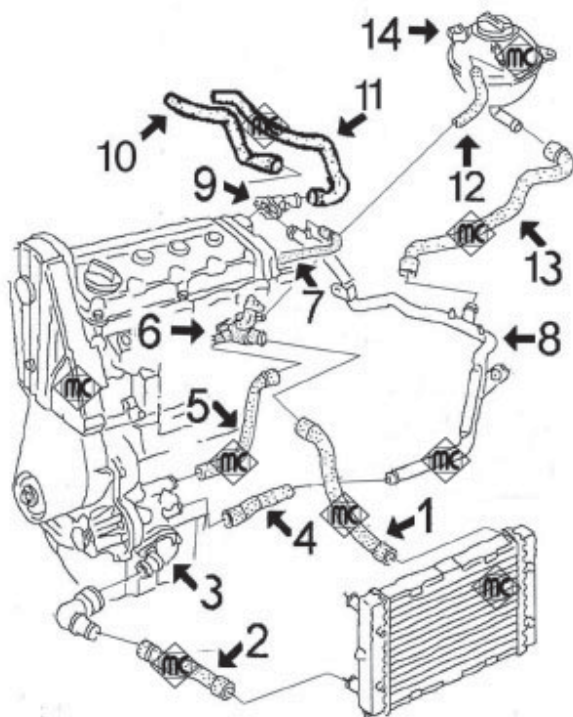

- 1- 8404 mgto superior radiador sin aire acondicionado  
8398 mgto superior radiador con aire acondicionado
- 2- 8403 mgto inferior radiador sin aire acondicionado  
8402 mgto inferior radiador con aire acondicionado
- 3- 3537 tapa de termostato  
3667 tapa de termostato completa con codo y juntas
- 4- 7993 mgto de bomba de agua a tubo hasta 11/'92  
8386 mgto de bomba de agua a tubo desde 11/'92
- 5- 8383 mgto de bomba de agua a culata
- 6- 3522 brida en culata conexión mgtos
- 7- 8391 mgto de tubo metálico a colector
- 8- 3083 tubo de agua metálico hasta 11/'92  
3084 tubo de agua metálico desde 11/'92
- 9- 3517 boquilla en culata (plástico)
- 10- 8395 mgto de tubo metálico a calefactor
- 11- 8396 mgto de culata a calefactor
- 12- 116 mgto de sobrante de botella a radiador, cortar de rollo MC-116 Ø 8x15 mm longitud 750 mm
- 13- 8378 mgto de tubo metálico a botella
- 14- 3504 botella de expansión con sensor de nivel  
3506 tapón botella de expansión

8224 mgto desvaporizador (sin catalizador)  
 8225 mgto desvaporizador (con catalizador)  
 8226 mgto desvaporizador



## VOLKSWAGEN GOLF - 3 (1992-1998)

**GOLF - 3**

**2.0  
2.0-16v  
1.6 (100CV)**

**motores 2E-ADY  
motor ABF  
motor AFT**

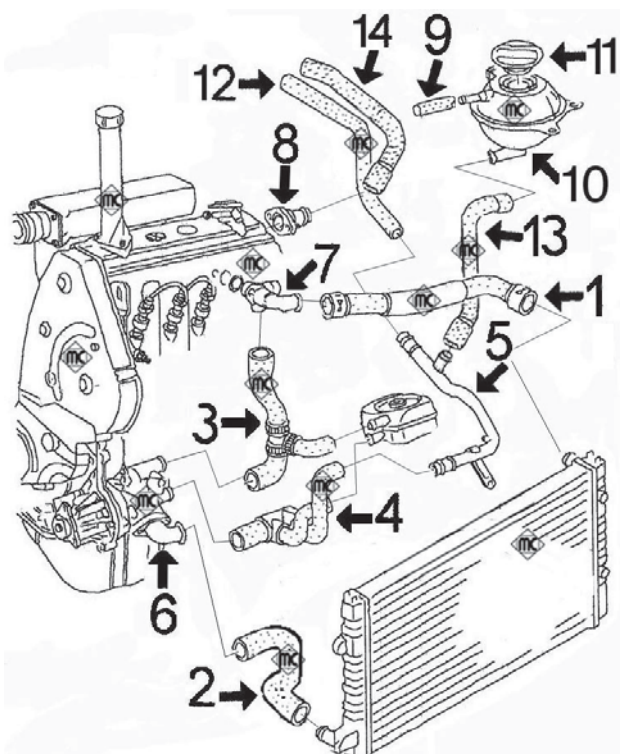

- |     |      |  |
|-----|------|--|
| 1-  | 8398 | mgto superior radiador   |
| 2-  | 8402 | mgto inferior radiador   |
| 3-  | 8394 | mgto de bomba a brida en culata 2.0 y 1.6 (100CV)  |
|     | 8414 | mgto de bomba a brida en culata 2.0-16v  |
| 4-  | 8384 | mgto de bomba a intercambiador y a tubo metálico 2.0                                     |
|     | 8386 | mgto de bomba a tubo metálico 1.6 (100CV)  |
| 5-  | 3084 | tubo de agua metálico 2.0  |
|     | 3095 | tubo de agua metálico 2.0-16v  |
| 6-  | 3537 | tapa de termostato   |
|     | 3667 | tapa de termostato completa con codo y juntas  |
| 7-  | 3522 | brida en culata conexión mgtos 2.0   |
|     | n/d  | brida en culata conexión mgtos 2.0-16v   |
| 8-  | 3517 | boquilla en culata (lateral)   |
|     | 3589 | boquilla en culata (lateral) 1.6-100cv   |
|     | 3583 | boquilla en culata (lateral) 2.0-16v.  |
| 9-  | 116  | mgto de sobrante de botella a radiador, cortar de rollo MC-116 Ø 8x15 mm longitud 750 mm |
| 10- | 3504 | botella de expansión   |
| 11- | 3506 | tapón botella de expansión   |
| 12- | 8395 | mgto de tubo metálico a calefactor   |
| 13- | 8378 | mgto de tubo metálico a botella de expansión   |
| 14- | 8396 | mgto de culata a calefactor  |
- 
- |  |      |  |
|--|------|--|
|  | 8228 | mgto desvaporizador 2.0 motor 2E (hasta 9/'94)   |
|  | 8853 | mgto desvaporizador 2.0 motor ADY (desde 10/'94) |
|  | 8229 | mgto desvaporizador de gases 2.0                 |

**GOLF - 3**

**1.9 Diesel  
1.9 TurboDiesel  
1.9 TDi  
1.9 SDi**

**motor 1Y  
motor AAZ  
motores 1Z-AEY-AFN-AHU-ALE  
motor AEY**

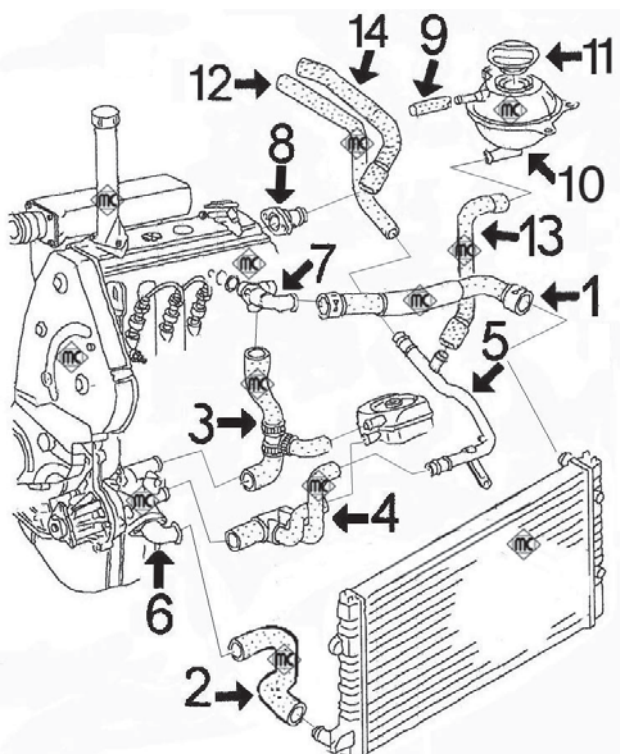

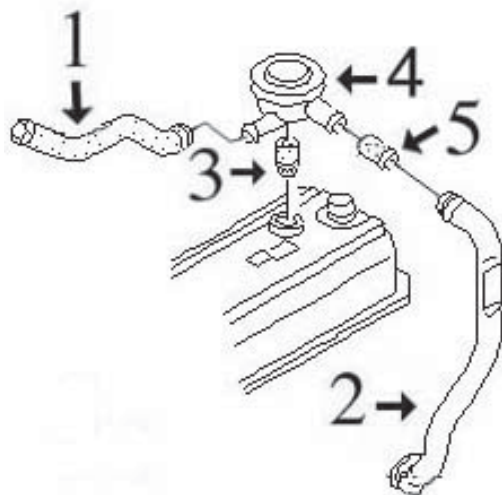

- |     |      |  |
|-----|------|--|
| 1-  | 8398 | mgto superior radiador Diesel y TurboD (sin toma para sensor)                            |
|     | 8470 | mgto superior radiador TDi-SDi (con toma para sensor)                                    |
| 2-  | 8402 | mgto inferior radiador   |
| 3-  | 8382 | mgto de bomba a brida en culata  |
| 4-  | 7993 | mgto de bomba a tubo hasta 11/'92  |
|     | 8384 | mgto de bomba a intercambiador y a tubo metálico desde 11/'92 (4 vias)                   |
| 5-  | 3083 | tubo de agua metálico hasta 11/'92   |
|     | 3084 | tubo de agua metálico Diesel y TD desde 11/'92   |
|     | 3094 | tubo de agua metálico TDi-SDi  |
| 6-  | 3537 | tapa de termostato   |
|     | 3667 | tapa de termostato completa con codo y juntas  |
| 7-  | 3527 | brida en culata conexión mgtos D-TD  |
|     | 3542 | brida en culata conexión mgtos TDi-SDi   |
| 8-  | 3517 | boquilla en culata (lateral)   |
| 9-  | 116  | mgto de sobrante de botella a radiador, cortar de rollo MC-116 Ø 8x15 mm longitud 750 mm |
| 10- | 3504 | botella de expansión   |
| 11- | 3506 | tapón botella de expansión   |
| 12- | 8395 | mgto de tubo metálico a calefactor   |
| 13- | 8378 | mgto de tubo metálico a botella de expansión   |
| 14- | 8396 | mgto de culata a calefactor  |

TUBOS DESVAPORIZADORES 1.9D - TD - TDi - SDi:



- 1- 8895 mgto de válvula desvaporizadora 1.9TDi  
8385 mgto de válvula desvaporizadora 1.9D
- 2- 3644 tubo plástico de válvula a cárter
- 3- 2669 junta válvula desvaporizadora
- 4- 3719 válvula desvaporizadora
- 5- 8385 mgto de válvula desvaporizadora 1.9D-TD (no TDi!)

## VOLKSWAGEN GOLF - 3 (1992-1998)

 <p><b>7968</b> mgto de tubo rígido a colector 1.4-1.6 r.o.030121054P</p>	 <p><b>7993</b> mgto de bomba agua a tubo metálico r.o.068121063M</p>	 <p><b>8224</b> mgto desvaporizador 1.8 con catalizador r.o.051103493A</p>
 <p><b>8225</b> mgto desvaporizador 1.8 sin catalizador r.o.051103493</p>	 <p><b>8226</b> mgto desvaporizador 1.8 r.o.050103493A-048103493A</p>	 <p><b>8227</b> mgto desvaporizador 1.6 sin catalizador r.o.026103493A</p>
 <p><b>8228</b> mgto desvaporizador 2.0 motor 2E hasta 9/94 r.o.037103493AB</p>	 <p><b>8229</b> mgto desvaporizador 2.0 r.o.037103493P</p>	 <p><b>8378</b> mgto de tubo metálico a botella r.o.535121109-1H0121109-1H0121109A</p>
 <p><b>8382</b> mgto de bomba a brida en culata Diesel r.o.028151053Q/S/L/P</p>	 <p><b>8383</b> mgto de bomba a brida en culata 1.8 r.o.037121053H</p>	 <p><b>8384</b> mgto de bomba a tubo e intercambiador r.o.037122058-037121058B-037122058B</p>
 <p><b>8385</b> mgto desvaporizador Diesel r.o.028103493E</p>	 <p><b>8386</b> mgto de bomba de agua a tubo metálico 1.8 r.o.037121063A</p>	 <p><b>8391</b> mgto de tubo metálico a colector 1.8 r.o.051121056</p>
 <p><b>8393</b> mgto de calefactor a brida 1.4-1.6 r.o.1H0819373A</p>	 <p><b>8394</b> mgto de bomba a brida en culata 2.0 r.o.037121053G-037121053J-037121036</p>	 <p><b>8395</b> mgto de tubo metálico a calefactor r.o.1H0819373C</p>
 <p><b>8396</b> mgto de culata a calefactor r.o.1H0819371</p>	 <p><b>8397</b> mgto de calefactor a tubo rígido 1.4-1.6 r.o.1H0819371A</p>	 <p><b>8398</b> mgto superior radiador Diesel y TD sin aire acondicionado, r.o.1H0121101B</p>

## VOLKSWAGEN GOLF - 3 (1992-1998)



**8402**  
mgto inferior radiador D-TD-Tdi y 2.0  
r.o. 1H0121051C/B/L°



**8403**  
mgto inferior radiador 1.8 sin aire acond.  
r.o. 1H0121051A



**8404**  
mgto superior radiador 1.8  
r.o. 1H0121101A



**8409**  
mgto de tubo rígido a brida agua 1.4-1.6  
r.o. 032121063



**8411**  
mgto de tubo a colector 1.4  
r.o. 030121056C/B



**8414**  
mgto de bomba a brida en culata 2.0-16v  
r.o. 037121053K



**8415**  
mgto desvaporizador 1.4-1.6  
r.o. 032103493E-030103493AH



**8416**  
mgto inferior radiador 1.4-1.6  
r.o. 1H0121051D



**8418**  
mgto superior radiador 1.4-1.6  
r.o. 1H0121101P



**8470** con toma para sensor  
mgto superior radiador TDi-SDi con aire ac.  
r.o. 1H0121101R



**8799**  
mgto de cuerpo termostato a colector 1.6  
r.o.



**8801**  
mgto de cuerpo termostato a culata 1.6  
r.o.



**8811**  
mgto desvaporizador 1.4-1.6 desde '95  
r.o.

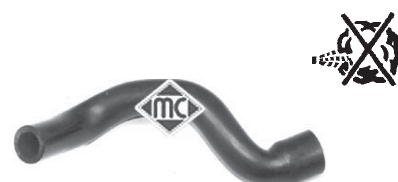

**8812**  
mgto desvaporizador 1.6 de '94 a '95  
r.o.



**8821** con toma para sensor  
mgto entrada a calefactor 1.4-1.6 desde '95  
r.o.



**8822**  
mgto de caja termostato a botella 1.4-1.6  
desde '95, r.o.



**8823**  
mgto superior radiador 1.4-1.6 desde '95  
r.o.



**8824**  
mgto retorno calefactor 1.4-1.6 desde '95  
r.o.























**8825**  
mgto inferior radiador 1.4-1.6 desde '95  
r.o.



**8846**  
mgto retorno calefactor 1.4-1.6 desde '95  
r.o.



## VOLKSWAGEN GOLF - 3 (1992-1998)

 <p><b>8847</b> mgto entrada calefactor 1.4-1.6 desde '95 r.o.</p>	 <p><b>8853</b> mgto desvaporizador 2.0-115CV motores ADY-AGG-AKR-AEP(desde 10/'94),r.o.</p>	 <p><b>8895</b> mgto desvaporizador 1.9TDi r.o.028103493S</p>
 <p><b>3083</b> tubo de agua metálico 1.8 y Diesel hasta '93 r.o.027121065D/E-028121065A</p>	 <p><b>3084</b> tubo de agua metálico 1.8 y Diesel desde '93 r.o.037121065K/L/G/H</p>	 <p><b>3094</b> tubo de agua metálico TDi - SDi r.o.0328121065K/T</p>
 <p><b>3095</b> tubo de agua metálico 2.0-16v r.o.037121065J</p>	 <p><b>3504</b> botella de expansión r.o.1H0121407A</p>	 <p><b>3506</b> tapón botella de expansión r.o.1H0121321A</p>
 <p><b>3517</b> boquilla en culata conexión mgto de calefactor,r.o.037121145</p>	 <p><b>3522</b> tapa de plástico en culata 1.8-2.0 r.o.037121133F-037121132E-037121132G</p>	 <p><b>3527</b> tapa de plástico en culata Diesel y TD r.o.068121132-068121133AB/AE</p>
 <p><b>3528</b> tapa de termostato 1.4-1.6 hasta '95 r.o.030121121B</p>	 <p><b>3537</b> tapa de termostato Golf-3 1.8-2.0-D-TD-TDi,r.o.037121121A</p>	 <p><b>3541</b> tapa de termostato 1.4-1.6 desde '95 r.o.030121121B-J</p>
 <p><b>3542</b> tapa de plástico en culata motores TDI-SDi r.o.028121132A</p>	 <p><b>3543</b> tapa de plástico conexión mgtos 1.4-1.6 r.o.030121117L-M</p>	 <p><b>3583</b> boquilla en culata (lateral) 2.0-16v. r.o.027121145B</p>
 <p><b>3588</b> tapa de termostato 1.6 AEA ('94-'95) r.o.032121121A</p>	 <p><b>3589</b> boquilla en culata (lateral) 1.6-100cv (AFT) r.o.037121145F-037121144H</p>	 <p><b>3592</b> kit de termostato completo con tapa y junta 1.4-1.6 motores AEX y AEE</p>

**VOLKSWAGEN GOLF - 3 (1992-1998)**

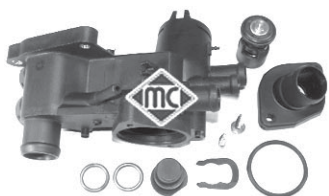

**3615**  
cuerpo con termostato 1.4-1.6 desde '95  
completo, r.o. 032121111N



**3618**  
tubo de agua (plástico) 1.4-1.6 hasta '95 con  
junta tórica, r.o. 030121065J



**3625**  
tubo de agua (plástico) 1.4-1.6 desde '95  
con juntas tóricas, r.o. 032121065D

**¡nuevo!**



**3644**  
tubo desvaporizador 1.9D-TD-TDi-SDi  
r.o. 028103491J

**¡nuevo!**



**3667**  
tapa de termostato 1.6-1.8-2.0-D-TD-TDi  
completa con codo, 037121121A+037121619

**¡nuevo!**



**3719**  
válvula desvaporizadora 1.9D-TD-TDi  
r.o. 028129101D



**2669**  
junta válvula desvaporizadora  
r.o. 028103500



**8377**  
mgto depresor servofreno todos mods.  
r.o. 321611939E

# VOLKSWAGEN GOLF - 3 (1992-1998)





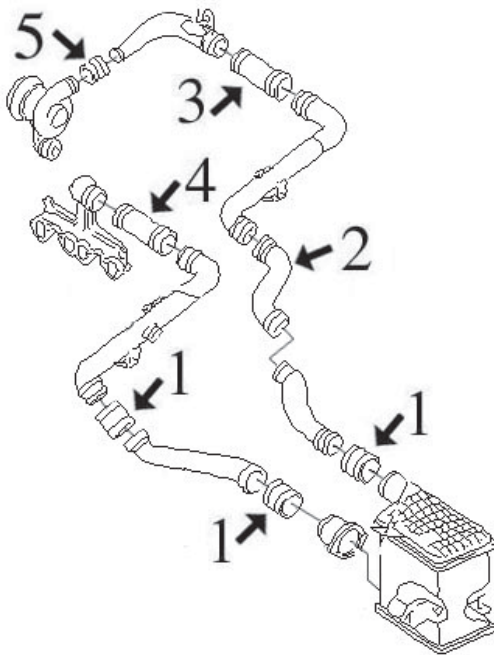

## CANALIZACIONES de AIRE de ALTA PRESION INTERCOOLER-TURBO:

**GOLF-3 1.9 Diesel motores TDi desde 5/'96 a 12/'97 (AHU-1Z-AFN-ALE)**



- 1- 9061 tubo flexible de empalme a intercooler
- 2- 9067 tubo flexible de empalme a tubo rígido
- 3- 9066 tubo flexible de empalme
- 4- 9060 tubo flexible empalme de colector de aspiración a tubo rígido
- 5- 9062 tubo flexible de empalme de turbo a tubo rígido

<p><b>¡Nuevo!</b></p>  <p><b>9060</b> tubo flexible de colector a tubo rígido r.o. 1H0145838G</p>	<p><b>¡Nuevo!</b></p>  <p><b>9061</b>      Ø 50x60 largo 58 mm tubo flexible de alta presion de empalme r.o. 1H0145834E</p>	<p><b>¡Nuevo!</b></p>  <p><b>9062</b>      Ø 35x45 largo 58 mm tubo flexible de alta presion de empalme r.o. 3A0145972A</p>
<p><b>¡Nuevo!</b></p>  <p><b>9066</b> tubo flexible de empalme r.o. 1H0145834G</p>	<p><b>¡Nuevo!</b></p>  <p><b>9067</b> tubo flexible de empalme a tubo rígido r.o. 1H0145834F</p>	

SUSPENSION DELANTERA y SOPORTES DE MOTOR:

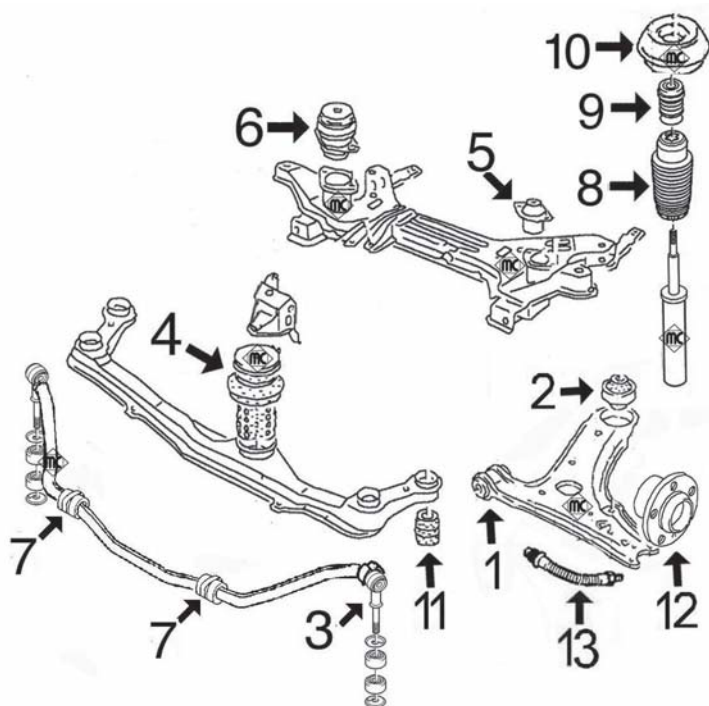

- 1- 542 silentbloc anterior trapecio delantero
- 2- 2660 silentbloc posterior trapecio delantero Golf-3
- 3- 646 bieleta puntal barra estabilizadora salvo 2.0 y 2.8
- 4336 bieleta puntal barra estabilizadora 2.0 y 2.8
- 4- 2685 soporte motor delantero
- 5- 2627 soporte motor trasero izquierdo 1.4 todos y 1.6 hasta '95
- 987 soporte motor trasero izquierdo 1.8-1.9D-2.0-1.6-100cv (AFT) y 1.6 desde '95
- 4362 soporte motor trasero izquierdo TD-TDi-SDi y 2.0-16v (ABF)
- 6- 2686 soporte motor trasero derecho todos salvo TDi
- 4363 soporte motor trasero derecho TDi-SDi
- 7- 917 goma para barra estabilizadora de Ø 18 mm
- 4266 goma para barra estabilizadora de Ø 20 mm
- 8- 4324 capuchón amortiguador delantero
- 9- 712 tope de amortiguador hasta '95 (goma)
- 4298 tope de amortiguador desde '95 (poliuretano)
- 4254 tope de amortiguador desde '95 (poliuretano) 2.0
- 10- 896 soporte amortiguador hasta '95
- 2812 soporte amortiguador desde '95
- 11- 2444 silentbloc soporte travesía delantera
- 12- 90073 buje rueda delantera todos salvo 2.0 y 2.8
- 90048 buje rueda delantera 2.0-2.0/16v y 2.8
- 13- 96181 latiguillo freno delantero (485 mm)

SUSPENSION TRASERA:

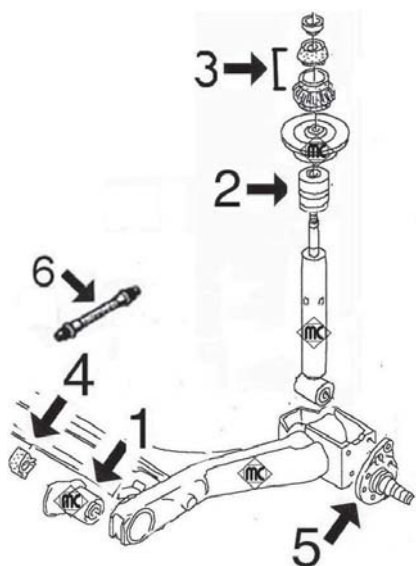

- 1- 2856 silentbloc brazo trasero suspensión Ø 56 mm
- 4875 silentbloc brazo trasero para suspensiones reforzadas Ø 69 mm
- 2- 2811 tope poliuretano amortiguador trasero
- 3- 4320 juego soportes amortiguador
- 4- 2824 goma barra estabilizadora
- 5- 90516 mangueta rueda trasera, freno de tambor sin ABS
- 90539 mangueta rueda trasera izquierda, tambor con ABS
- 90540 mangueta rueda trasera derecha, tambor con ABS
- 90541 mangueta rueda trasera izquierda, freno de disco
- 90542 mangueta rueda trasera derecha, freno de disco
- 6- 96126 latiguillo freno trasero (166 mm)
- 96175 latiguillo freno trasero (190 mm)



VOLKSWAGEN GOLF - 3 (1992-1998)



**542**  
silentbloc anterior trapecio delantero  
r.o. 191407182E



**646**  
bieleta puntal barra estabilizadora  
r.o. 191411315



**712**  
tope de goma amortiguador delantero  
hasta '96, r.o. 357412303E



**896**  
soporte amortiguador delantero hasta '95  
r.o. 191412329

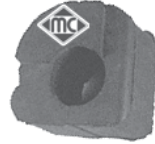

**917**  
goma para barra estabilizadora de Ø 18 mm  
r.o. 191411314



**987**  
soporte motor trasero izquierdo salvo TDi  
r.o. 357199402B



**2444**  
silentbloc sub-chasis delantero  
r.o. 1H0199233A



**2627**  
soporte motor trasero izquierdo 1.4-1.6  
r.o. 191199381A



**2660**  
silentbloc posterior trapecio delantero  
(aluminio) r.o. 191407181E



**2685**  
soporte motor delantero  
r.o. 1H0199609E/F



**2686**  
soporte motor derecho salvo TDi-SDi  
r.o. 1H0199262A/E/F



**2811**  
tope poliuretano suspensión trasera  
r.o. 191512131B

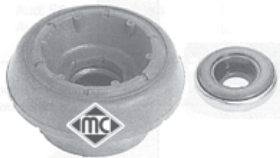

**2812**  
soporte amortiguador delantero desde '95  
con rodamiento, r.o. 357412331A

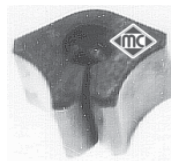

**2824**  
goma barra estabilizadora trasera  
r.o. 871511423

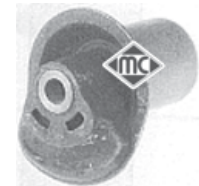

**2856**  
silentbloc brazo trasero (Ø 56,5 mm)  
r.o. 1H0501541-1H0501541A



**4254**  
tope amortiguador delantero desde '95 salvo 2.0, r.o. 357412303F

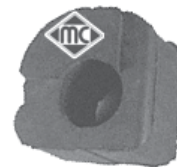

**4266**  
goma para barra estabilizadora de Ø 20 mm  
r.o. 1H0411314



**4298**  
tope amortiguador delantero 2.0 desde '95  
r.o. 1H0412303B



**4320**  
juego soportes amortiguador trasero  
r.o. 191512333+191512335



**4324**  
capuchón amortiguador delantero  
r.o. 357413175A

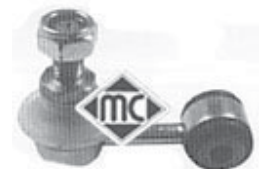

**4336**  
bieleta puntal barra estabilizadora 2.0 y 2.8, r.o. 535411315

## VOLKSWAGEN GOLF - 3 (1992-1998)



**4362**

soporte motor trasero izquierdo TD-TDi-  
-SDi, r.o. 3A0199402



**4363**

soporte motor trasero derecho TDi-SDi  
r.o. 1H0199262L/J

**Nuevo!**



**4875**

silentbloc puente trasero, suspensión  
reforzada (Ø69 mm), r.o. 1J0501541D



**90073**

buje rueda delantera todos salvo 2.0-2.8  
(Ø120 mm), r.o. 357407615



**90048**

buje rueda delantera 2.0-2.8 (Ø 127 mm)  
r.o. 1H0407613B



**90516**

mangueta rueda trasera freno de tambor  
sin ABS, r.o. 357501117



**90539**

mangueta rueda trasera **izquierda**, tambor  
con ABS, r.o. 333501117A



**90540**

mangueta rueda trasera **derecha**, tambor  
con ABS, r.o. 333501118A



**90541**

mangueta rueda trasera **izquierda**, freno  
de disco, r.o. 333501117



**90542**

mangueta rueda trasera **derecha**, freno  
de disco, r.o. 333501118



**96124**

latiguillo freno delantero (485 mm)  
r.o. 1H0611701



**96126**













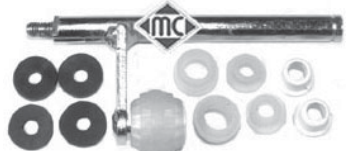







latiguillo freno trasero (160 mm)  
(racores hembra-hembra), r.o. 1H0611775

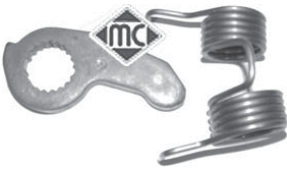

**96175**

latiguillo freno trasero (190 mm)  
(racores hembra-macho), r.o. 481611775

## VOLKSWAGEN GOLF - 3 (1992-1998)

<p><b>¡Nuevo!</b></p>  <p><b>3724</b> rótula base palanca de cambio 1.4-1.6 r.o. 191711251A</p>	 <p><b>2878</b> varilla selector de velocidades 1.8-1.9D-1.9TD-2.0 (salvo TDi y 16v), r.o. 1H0711574</p>	 <p><b>2841</b> juego reparación palanca cambio r.o. 1H0711173+171711067B</p>
 <p><b>2879</b>                      <b>largo 60 mm</b> bieleta selector de velocidades 1.8-1.9D-TD y 2.0, r.o. 1H0711595</p>	 <p><b>4141</b> péndulo selector velocidades TDi hasta '96 r.o. 1L0711051</p>	 <p><b>4360</b> péndulo selector velocidades TDi d/ '96 r.o. 1H0711051B</p>
 <p><b>4361</b> soporte barra cambio completa con casquillos todos salvo TDi y 2.0-16v., r.o.</p>	<p><b>¡Nuevo!</b></p>  <p><b>3691</b> articulación cambio 1.9TDi y 2.0 r.o. 1J0711256</p>	 <p><b>4045</b>                      <b>long. 284 mm</b> palanca de cambio salvo TDi y 16v. r.o. 1H0711116A</p>
<p><b>¡Nuevo!</b></p>  <p><b>4902</b> articulación cambio 1.4-1.6 hasta '99, r.o. 191711233</p>	 <p><b>2854</b> tope cable embrague r.o. 1H0798303A</p>	<p><b>¡Nuevo!</b></p>  <p><b>4749</b> guía embrague con retén 1.9TDi y 2.0 r.o. 02A141180A</p>
<p><b>¡Nuevo!</b></p>  <p><b>4903</b> casquillo guía embrague 1.4-1.6 r.o. 085141181</p>	<p><b>¡Nuevo!</b></p>  <p><b>4772</b> juego palanca de desembrague 1.8-2.0-1.9D-TD, r.o. 02K141709A+020141723C</p>	<p><b>¡Nuevo!</b></p>  <p><b>4906</b> varilla accionamiento embrague (341 mm) 1.8-1.9D-TD, r.o. 020141741B</p>
 <p><b>1511</b> fuelle cremallera manual r.o. 191419831</p>	<p><b>¡Nuevo!</b></p>  <p><b>1765</b> fuelle cremallera asistida "TRW" r.o. 175422831</p>	 <p><b>1765-C</b> kit reparación cremallera asistida "TRW" r.o.</p>
 <p><b>1100</b> fuelle cremallera asistida "ZF" r.o. 357422831B</p>	 <p><b>1100-C</b> kit reparación cremallera asistida "ZF" r.o.</p>	 <p><b>2301</b> casquillo cremallera manual r.o.</p>



## VOLKSWAGEN GOLF - 3 (1992-1998)



**1921**  
kit fuelle transmisión l/rueda  
homocinética de 77 mm, r.o.1H0407285A



**1297**  
kit fuelle transmisión l/rueda  
homocinética de 86 mm r.o.1H0407285A



**1632**  
kit rep. transmisión l/cbo 1.4-1.6 hasta '96  
(Ø 21-89 mm), r.o. 171498201A

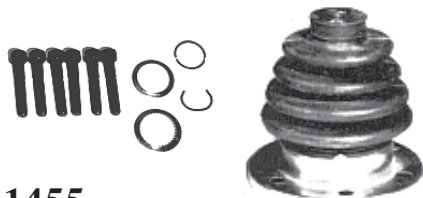

**1455**  
kit rep. transm. l/cambio 1.4-1.6 desde '96  
(Ø 21-94 mm), r.o. 191498201D



**1560**  
kit rep. transm. izquierda l/cambio 1.8-1.9D-  
TDi-2.0-r.o. 191498201B-357498201 (Ø 100)



**1637**  
kit rep. transmisión derecha l/cbo 1.8-1.9D  
TD-TDi-2.0, r.o. 191498202A (Ø 100)

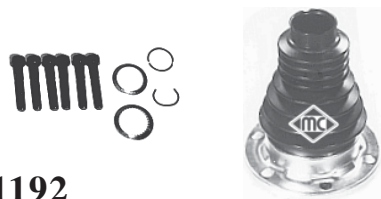

**1192**  
kit fuelle transm. l/cambio desde '96 (Ø 100)  
r.o. 6Q0498201B



**2699**  
soporte carburador 1.4-1.6 hasta '95  
r.o.030129765G



**2695**  
soporte cuerpo inyección 1.8  
r.o.050129761H/F/B/A



**3688**  
guía varilla nivel aceite 1.4-1.6 hasta '95  
r.o.036115636

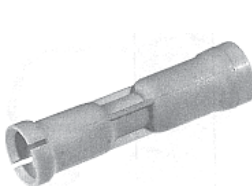

**2448**  
guía varilla nivel aceite 1.8-2.0  
r.o.053103663



**2876**  
guía varilla nivel aceite 1.9D-TD-TDi  
r.o.028103663B



**4355**  
guía varilla nivel aceite 1.4-1.6 desde '95  
r.o. 030115636A



**4760**  
varilla nivel aceite 1.8-2.0  
r.o.027115611C



**4942**  
varilla nivel aceite 1.9D-TD-TDi  
r.o.028115611C



**4405**  
polea cigueñal 2.0 gasolina  
r.o.06A105243E



**4290**  
polea cigueñal Diesel-TurboD-TDi y SDi  
r.o.028105243T-028105243K

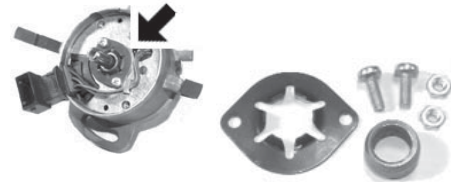

**4296**  
kit reparación distribuidor Magneti-Marelli  
(casquillo sinterizado del eje rotor)



**3715**  
tapa correa distribución 1.8  
r.o.026109107B



**3681**  
tapa correa distribución 1.8  
r.o.026109173A



**4365**  
jgo. tornillo sujeción tapa cubremotor  
r.o.028103665+028103937+028103638G



## VOLKSWAGEN GOLF - 3 (1992-1998)

<p><b>4768</b> rodillo tensor correa alternador 1.8-2.0-1.9D r.o.028145278E</p> <p><i>¡Nuevo!</i></p>  <p style="text-align: right;">Ø 78 mm</p>	<p><b>4908</b> tensor correa alternador 1.9D-TD-TDi r.o.28903315R</p> <p><i>¡Nuevo!</i></p> 	<p><b>4909</b> tensor correa alternador 1.6/1.8/2.0 r.o.037903315C</p> <p><i>¡Nuevo!</i></p> 
<p><b>4770</b> tensor correa alternador 1.4-1.6 r.o.030145299F</p> <p><i>¡Nuevo!</i></p> 	<p><b>4919</b> polea alternador de rueda libre r.o.028903119AA</p> <p><i>¡Nuevo!</i></p> 	<p><b>4766</b> guía cerradura maneta puerta r.o.1H0837223B</p> <p><i>¡Nuevo!</i></p> 
<p><b>3672</b> válvula filtro gasoil r.o.19112724A</p> 	<p><b>016</b> tapón cierre inyectores Diesel r.o.</p> 	<p><b>3708</b> tapón llenado combustible r.o.1J0201553C</p> <p><i>¡Nuevo!</i></p>  
<p><b>2425</b> soporte trasero tubo de escape r.o.1H0253144A/C</p> 	<p><b>2426</b> soporte tubo de escape r.o.1H0253147B</p> 	<p><b>4124</b> soporte delantero tubo de escape 1.8-2.0 2.8 y TDi hasta '96, r.o.1H0253147D</p> 
<p><b>4364</b> soporte delantero tubo escape TDi desde '96 r.o.1H0253144E</p> 	<p><b>2780</b> junta de colector a motor 1.9TDi r.o.028129589B</p> 	<p><b>3739</b> interruptor luz de freno r.o.191945511-191945511A/B</p> <p><i>¡Nuevo!</i></p> 
<p><b>3621</b> tapón llenado aceite motor r.o.06A103485F</p>  	<p><b>864</b> cubrepedal freno y embrague r.o.321721173</p> 	<p><b>792</b> tuerca rueda r.o.3A0601139</p> 
<p><b>674</b> tapón cárter de aceite 14x150 r.o.113115193</p> 		

## VOLKSWAGEN GOLF-4 (1998-2004)

### CANALIZACIONES DE AGUA:

**GOLF-4** 1.4/16v  
1.6/8v  
1.6/16v

**motores AHW-AXP-BCA**  
**motores APF-AVU**  
**motores AUS-AZD-BCB**

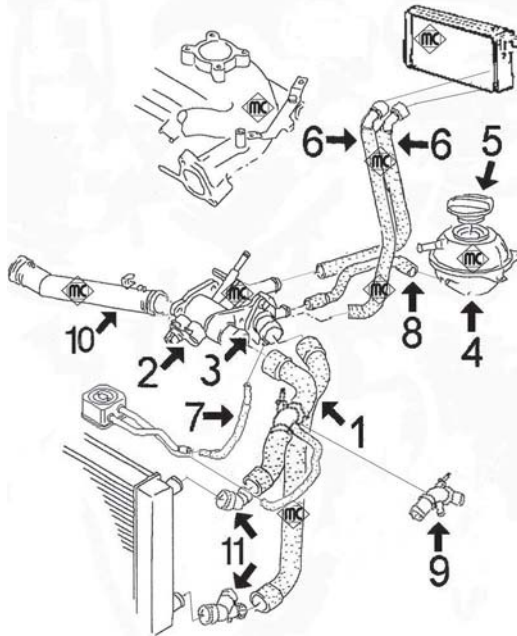

- 1- 9078 mgto doble superior/inferior 1.4/16v completo con conectores rápidos salvo 1.6-APF-AVU
- 9079 mgto doble superior/inferior 1.6/16v completo con conectores rápidos
- 2- 3615 caja de termostato completa
- 3- 3592 kit de termostato completo con tapa y junta salvo 1.6 APF-AVU
- 3541 tapa de termostato salvo 1.6APV-AVU
- 3745 tapa con termostato 1.6 100/102 CV APF-AVU
- 4- 3635 botella de expansión
- 5- 3573 tapón botella de expansión
- 6- 9052 mgto doble de entrada/salida calefactor completo con conectores rápidos
- 7- 9054 mgto de intercambiador a caja termostato (sólo 1.6)
- 8- 9044 mgto de caja termostato a botella
- 9- 3604 conector mgto superior completo con accesorios
- 10- 3625 tubo de agua (plástico) de bomba a caja termostato
- 11- 3721 juego de conectores superior/inferior en mgto radiador
  
- 9055 mgto desvaporizador

**GOLF-4** 1.6/8v

**motores AEH-AKL-AVU**

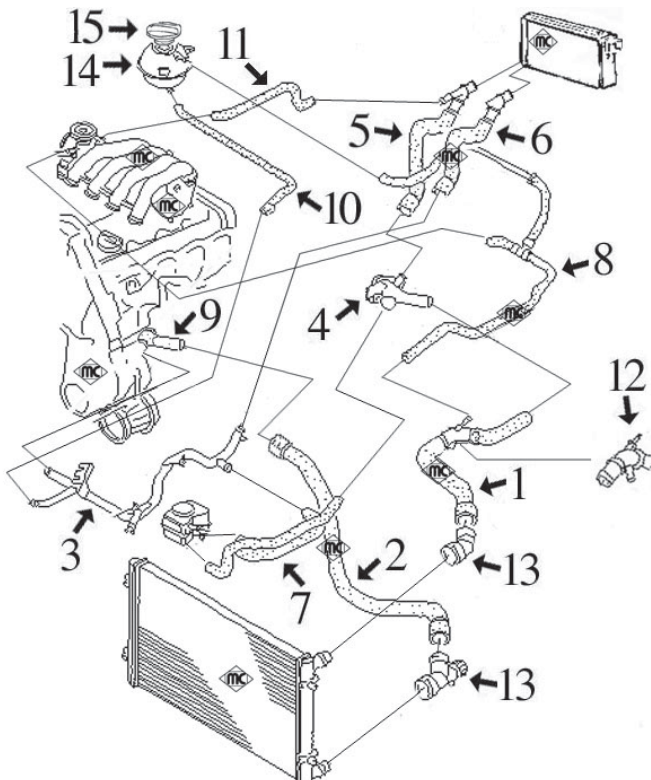

- 1- 9045 mgto superior radiador completo con conector rápido
- 2- 9046 mgto inferior radiador completo con conector rápido
- 3- 3176 tubo de agua metálico completo con junta tórica
- 4- 3598 boquilla (plástico) en culata
- 5- 9051 mgto de calefactor a boquilla en culata (con conector rápido)
- 6- 9042 mgto de calefactor a tubo metálico (con conector rápido)
- 7- 9048 mgto doble de intercambiador en filtro de aceite
- 8- n/d mgto a caja mariposa y reboso botella
- 9- 3597 boquilla en bloque (plástico)
- 10- 9043 mgto de tubo metálico a botella
- 11- n/d mgto de caja mariposa a conector en mgto calefactor
- 12- 3604 conector mgto superior completo con accesorios
- 13- 3721 juego de conectores superior/inferior en mgto radiador
- 14- 3635 botella de expansión
- 15- 3573 tapón botella de expansión

# VOLKSWAGEN GOLF-4 (1998-2004)

GOLF-4 1.8  
2.0

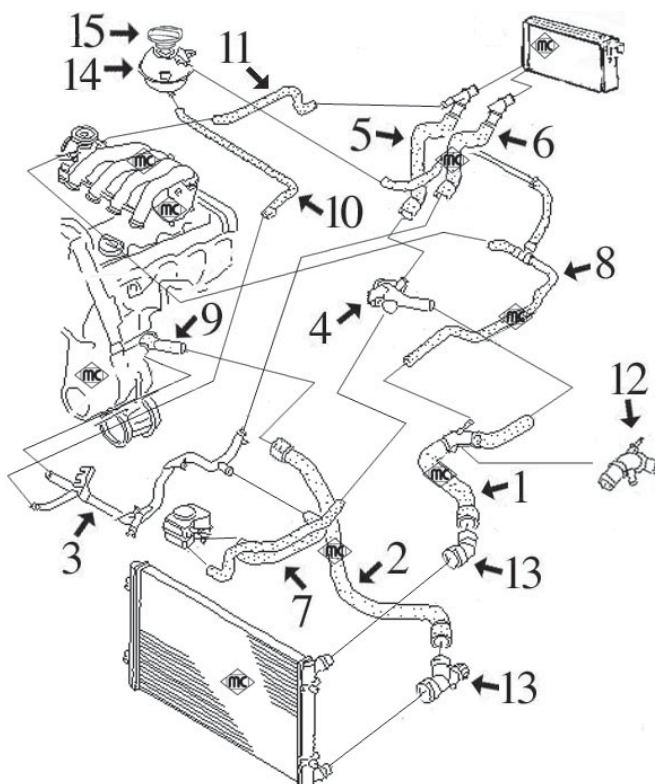

- 1- 9045 mgto superior radiador completo con conector rápido
- 2- 9046 mgto inferior radiador completo con conector rápido
- 3- 3177 tubo de agua metálico completo con junta tórica, motor 1.8  
3176 tubo de agua metálico completo con junta tórica, motor 2.0
- 4- 3598 boquilla (plástico) en culata motor AGN
- 5- 9051 mgto de calefactor a boquilla en culata (con conector rápido)
- 6- 9042 mgto de calefactor a tubo metálico (con conector rápido)
- 7- 9048 mgto doble de intercambiador en filtro de aceite, motor 1.8  
9049 mgto doble de intercambiador en filtro de aceite, motor 2.0
- 8- n/d mgto a caja mariposa y rebose botella
- 9- 3597 boquilla en bloque (plástico)
- 10- 9043 mgto de tubo metálico a botella
- 11- n/d mgto de caja mariposa a conector en mgto calefactor
- 12- 3604 conector mgto superior completo con accesorios
- 13- 3721 juego de conectores superior/inferior en mgto radiador
- 14- 3635 botella de expansión
- 15- 3573 tapón botella de expansión

GOLF-4 1.9 Diesel

SDi de 68CV  
TDi de 90CV  
TDi de 110CV



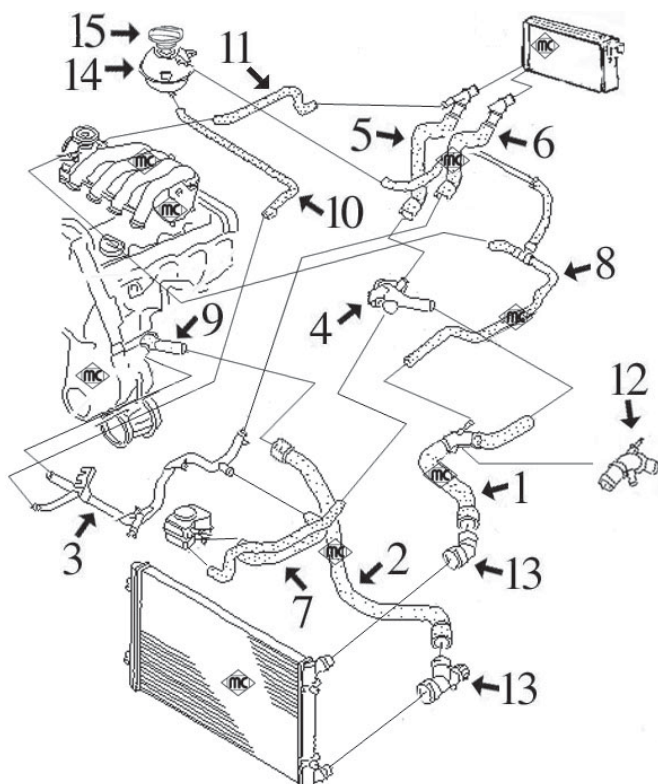













motor AQM  
motores AGR-ALH  
motores AHF-ASV



- 1- 9045 mgto superior radiador completo con conector rápido
  - 2- 9046 mgto inferior radiador completo con conector rápido
  - 3- 3178 tubo de agua metálico completo con junta tórica
  - 4- 3591 boquilla (plástico) en culata
  - 5- 9050 mgto de calefactor a boquilla en culata (con conector rápido)
  - 6- 9042 mgto de calefactor a tubo metálico (con conector rápido)
  - 7- 9047 mgto doble de intercambiador en filtro de aceite
  - 8- n/d mgto a caja mariposa y rebose botella
  - 9- 3590 boquilla en bloque (plástico)
  - 10- 9043 mgto de tubo metálico a botella
  - 11- n/d mgto de caja mariposa a conector en mgto calefactor
  - 12- 3604 conector mgto superior completo con accesorios
  - 13- 3721 juego de conectores superior/inferior en mgto radiador
  - 14- 3635 botella de expansión
  - 15- 3573 tapón botella de expansión
- 3722 tubo desvaporizador hasta 5/'99  
3728 tubo desvaporizador desde 5/'99



VOLKSWAGEN GOLF-4 (1998-2004)

<p><b>¡Nuevo!</b></p>  <p><b>9042</b> mgto de tubo metálico a calefactor r.O.</p>	<p><b>¡Nuevo!</b></p>  <p><b>9043</b> mgto de botella a tubo metálico r.O.</p>	<p><b>¡Nuevo!</b></p>  <p><b>9044</b> mgto de caja termostato a botella r.O.</p>
<p><b>¡Nuevo!</b></p>  <p><b>9045</b> mgto inferior radiador r.O.</p>	<p><b>¡Nuevo!</b></p>  <p><b>9046</b> mgto superior radiador r.O.</p>	<p><b>¡Nuevo!</b></p>  <p><b>9047</b> mgto doble de intercambiador r.O.</p>
<p><b>¡Nuevo!</b></p>  <p><b>9048</b> mgto doble de intercambiador 1.6-1.8 r.O.</p>	<p><b>¡Nuevo!</b></p>  <p><b>9049</b> mgto doble de intercambiador 2.0 r.O.</p>	<p><b>¡Nuevo!</b></p>  <p><b>9050</b> mgto de culata a calefactor r.O.</p>
<p><b>¡Nuevo!</b></p>  <p><b>9051</b> mgto de culata a calefactor r.O.</p>	<p><b>¡Nuevo!</b></p>  <p><b>9052</b> mgto doble de calefactor r.O.</p>	<p><b>¡Nuevo!</b></p>  <p><b>9053</b> mgto de calefactor a boquilla en culata r.O.</p>
<p><b>¡Nuevo!</b></p>  <p><b>9054</b> mgto de caja de termostato a intercambiador r.O.</p>	<p><b>¡Nuevo!</b></p>  <p><b>9055</b> mgto desvaporizador 1.4/16v-1.6/16v r.O.</p>	<p><b>¡Nuevo!</b></p>  <p><b>9078</b> mgto doble superior/inferior 1.4/16v r.O.</p>
<p><b>¡Nuevo!</b></p>  <p><b>9079</b> mgto doble superior/inferior 1.6/16v r.O.</p>		



## VOLKSWAGEN GOLF-4 (1998-2004)

<p><b>¡Nuevo!</b></p>  <p><b>3176</b> tubo de agua metálico 1.6(8v) y 2.0 r.o.</p>	<p><b>¡Nuevo!</b></p>  <p><b>3177</b> tubo de agua metálico 1.8 r.o.</p>	<p><b>¡Nuevo!</b></p>  <p><b>3178</b> tubo de agua metálico 1.9SDi-1.9TDi r.o.</p>
 <p><b>3541</b> tapa de termostato 1.4/16v-1.6/16v r.o.032121121J</p>	 <p><b>3590</b> tapa de termostato 1.9SDi-1.9TDi r.o.038121121</p>	 <p><b>3592</b> kit completo tapa termostato y junta 1.4/ /16v-1.6/16v,r.o.032121121J+032121110B</p>
 <p><b>3597</b> tapa de termostato 1.6(8v)-1.8-2.0 r.o.06A121121C-038121121D</p>	 <p><b>3598</b> tapa de agua en culata (lateral) 1.6(8v)-1.8 y 2.0,r.o.06A121132</p>	
 <p><b>3604</b> kit completo empalme manguito superior radiador,r.o. 1J0121087A+accesorios</p>	 <p><b>3615</b> caja de termostato 1.4/16v-1.6/16v r.o.032121111N</p>	 <p><b>3625</b> tubo de agua 1.4/16v-1.6/16v r.o.032121065D</p>
 <p><b>3635</b> botella de expansión r.o. 1J0121403B</p>	 <p><b>3573</b> tapón botella de expansión r.o. 1J0121321B</p>	<p><b>¡Nuevo!</b></p>  <p><b>3721</b> juego conectores manguitos de radiador r.o.</p>
<p><b>¡Nuevo!</b></p>  <p><b>3722</b> tubo desvaporizador 1.9SDi-TDi desde 5/99 r.o.038103493P</p> 	<p><b>¡Nuevo!</b></p>  <p><b>3723</b> válvula desvaporizadora 1.9SDi-TDi r.o.028129101E</p>	<p><b>¡Nuevo!</b></p>  <p><b>3728</b> tubo desvaporizador 1.9SDi-TDi hasta 5/99 r.o.038103493A</p> 
<p><b>¡Nuevo!</b></p>  <p><b>3745</b> tapa con termostato 1.6 100/102 CV motores APFy AVU,r.o.06A121114</p>	 <p><b>2669</b> junta válvula desvaporizadora r.o.028103500</p> 	



CANALIZACIONES de AIRE de ALTA PRESION INTERCOOLER-TURBO:

GOLF-4 1.9 Diesel TDi motores de 90 y 110CV

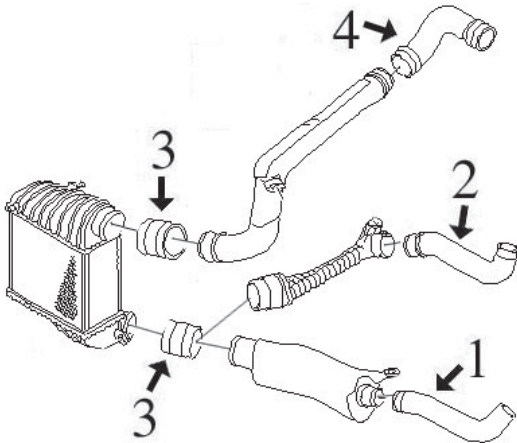

- 1- n/d tubo flexible de empalme hasta 5/'99
- 2- 9070 tubo flexible de empalme desde 5/'99
- 3- 9064 tubo flexible de intercooler a tubo rígido
- 4- 9068 tubo flexible de tubo rígido a colector de aspiración

GOLF-4 1.9 Diesel TDi motores de 130 y 150CV

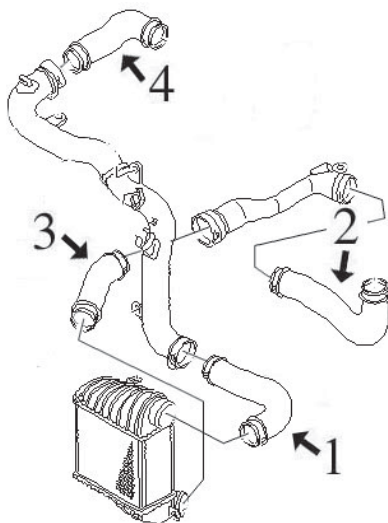

- 1- 9091 tubo flexible de intercooler a tubo, TDi de 150CV
- 9092 tubo flexible de intercooler a tubo, TDi de 130CV
- 2- n/d tubo flexible a intercooler
- 3- 9093 tubo flexible de intercooler a tubo, TDi de 150CV
- 9092 tubo flexible de intercooler a tubo, TDi de 130CV
- 4- 9094 tubo flexible de tubo rígido a colector de aspiración, TDi de 130CV

## VOLKSWAGEN GOLF-4 (1998-2004)

<p><b>¡Nuevo!</b></p>  <p><b>9064</b>  <math>\text{\O} 60 \times 70</math> largo 58 mm                      tubo flexible de intercooler a tubo r�gido                      r.o. 1J0145834A</p>	<p><b>¡Nuevo!</b></p>  <p><b>9068</b>                      tubo flexible de tubo r�gido a colector                      r.o. 1J0145838B</p>	<p><b>¡Nuevo!</b></p>  <p><b>9070</b>                      tubo de empalme desde 5/99 90-110CV                      r.o. 1J0145828T</p>
<p><b>¡Nuevo!</b></p>  <p><b>9091</b>                      tubo de intercooler a tubo r�gido 150CV                      r.o. 1J0145834AE</p>	<p><b>¡Nuevo!</b></p>  <p><b>9092</b>                      tubo flexible de intercooler a tubo r�gido                      r.o. 1J0145834AB</p>	<p><b>¡Nuevo!</b></p>  <p><b>9093</b>                      tubo de intercooler a tubo r�gido 150CV                      r.o. 1J0145834AA</p>
<p><b>¡Nuevo!</b></p>  <p><b>9094</b>                      tubo de tubo r�gido a colector de aspiraci�n                      r.o. 1J0145838AF</p>		

SUSPENSION DELANTERA y SOPORTES DE MOTOR:

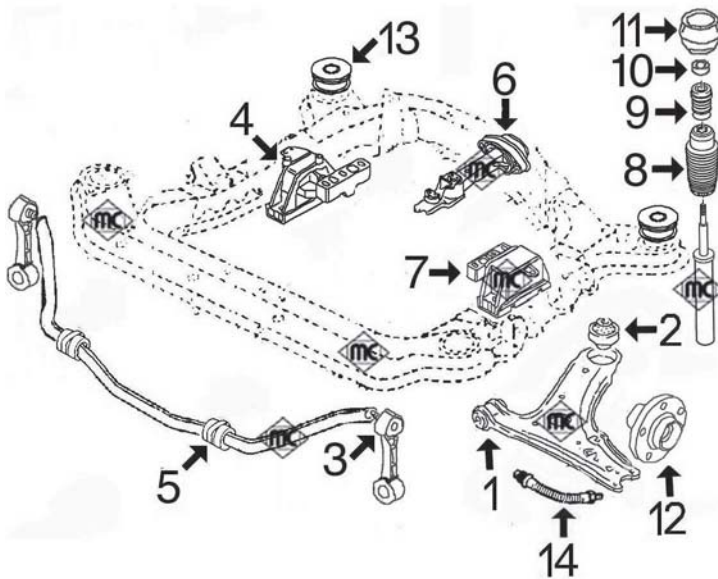

- 1- 542 silentbloc anterior trapecio delantero
- 2- 2963 silentbloc posterior trapecio delantero
- 3- 4250 bieleta puntal barra estabilizadora (plástico)
- 4249 bieleta puntal barra estabilizadora (metal)
- 4- 4368 soporte motor derecho 1.4-1.6 (105cv y 16v)-2.3V5
- 4186 soporte motor derecho 1.6 (100 y 102cv)-1.8-2.0 1.9SDi-1.9TDi
- 5- 4369 goma para barra estabilizadora de Ø 20 y 21 mm
- 4321 goma para barra estabilizadora de Ø 23 mm
- 6- 4133 soporte motor trasero
- 7- 4187 soporte motor izquierdo
- 8- 4324 capuchón amortiguador delantero
- 9- 4298 tope poliuretano amortiguador
- 10- 4128 rodamiento soporte amortiguador
- 11- 4177 soporte amortiguador completo con rodamiento
- 12- 90063 buje de rueda delantera
- 13- 4134 soporte sub-chasis trasero
- 14- 96013 latiguillo freno delantero (435 mm)

SUSPENSION TRASERA:

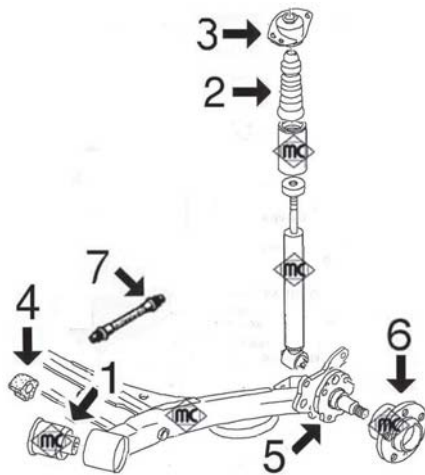

- 1- 4310 silentbloc brazo suspensión trasero
- 2- 4312 tope poliuretano amortiguador trasero
- 3- 4311 soporte amortiguador trasero
- 4- 2824 goma barra estabilizadora
- 5- n/d mangueta brazo trasero
- 6- 90521 buje rueda trasera
- 7- 96014 latiguillo freno trasero (165 mm)



**542**  
silentbloc anterior trapecio delantero  
r.o.357407182

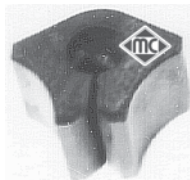

**2824**  
goma barra estabilizadora trasera  
r.o.871511423



**2963**  
silentbloc posterior trapecio delantero  
r.o.1J0407181



**4128**  
rodamiento soporte amortiguador delantero  
r.o.1J0412249



**4133**  
soporte motor trasero  
r.o.1J0199851AA



**4134**  
silentbloc sub-chasis trasero  
r.o.1J0199429



## VOLKSWAGEN GOLF-4 (1998-2004)



**4177**  
soporte amortiguador delantero completo  
con rodamiento, r.o. 1J0412331C

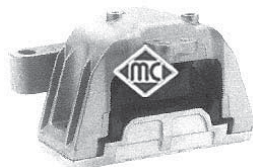

**4186**  
soporte motor derecho 1.6(100 y 102cv)-1.8-  
-2.0-1.9TDi-1.9SDi, r.o. 1J0199262BF



**4187**  
soporte motor izquierdo  
r.o. 1J0199555AJ/AK



**4249**  
bieleta puntal barra estabilizadora (metálica)  
r.o. 1J0411315G



**4250**  
bieleta puntal barra estabilizadora (plástico)  
r.o. 1J0411315C



**4298**  
tope poliuretano amortiguador delantero  
r.o. 1H0412303B



**4310**  
silentbloc brazo trasero suspensión  
r.o. 1J0501541C



**4311**  
soporte amortiguador trasero  
r.o. 1J0512353C



**4312**  
tope poliuretano amortiguador trasero  
r.o. 1J0512131-1J0512131B



**4321**  
goma para barra estabilizadora de Ø 23 mm  
r.o. 1J0411314G



**4324**  
capuchón amortiguador delantero  
r.o. 357413175A

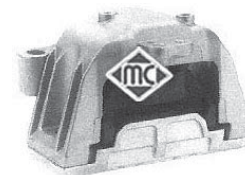

**4368**  
soporte motor derecho 1.4-1.6 (de 105cv)  
-1.6/16v y 2.3V5, r.o. 1J0199262BK/BH

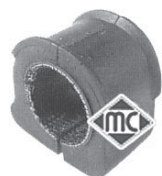

**4369**  
goma para barra estabilizadora de Ø 20 y  
21 mm, r.o. 1J0411314C



**90063**  
buje rueda delantera  
r.o. 1J0407613C



**90521**  
buje rueda trasera  
r.o. 1J0598477























**96013**  
latiguillo freno delantero (435 mm)  
r.o. 1J0611701



**96014**  
latiguillo freno trasero (165 mm)  
r.o. 6X0611775

## VOLKSWAGEN GOLF-4 (1998-2004)

<p><b>¡Nuevo!</b></p>  <p><b>4758</b> varilla nivel aceite 1.4/16v-1.6/16v r.o.</p>	<p><b>¡Nuevo!</b></p>  <p><b>4795</b> varilla nivel aceite 1.6/8v-1.8/20v y 2.0 r.o.</p>	<p><b>¡Nuevo!</b></p>  <p><b>4759</b> varilla nivel aceite 1.9TDi-SDi r.o.</p>
 <p><b>4355</b> guía varilla nivel aceite 1.4/16v-1.6/16v r.o.030115636A</p>	 <p><b>3568</b> guía varilla nivel aceite 1.6/8v r.o.06A103663B</p>	 <p><b>3553</b> guía varilla nivel aceite 1.8/20v r.o.06A103663C</p>
 <p><b>3571</b> guía varilla nivel aceite 1.9SDi-1.9TDi r.o.038103663</p>	<p><b>¡Nuevo!</b></p>  <p><b>3720</b> tapa correa distribución 1.6(100CV) y 2.0 r.o.06A109108S</p>	 <p><b>4365</b> juego tornillos sujeción tapa motor r.o.028103638G+028103665+028103937</p>
<p><b>¡Nuevo!</b></p>  <p><b>4421</b> polea cigüeñal 1.9TDi-SDi todos hasta '03 r.o.038105243</p>	<p><b>¡Nuevo!</b></p>  <p><b>4480</b> polea cigüeñal 1.9TDi desde '03- r.o.03G105243</p>	<p><b>¡Nuevo!</b></p>  <p><b>4494</b> polea cigüeñal 1.9SDi desde '03- r.o.038105243L</p>
 <p><b>4405</b> polea cigüeñal 1.8 gasolina r.o.06A105243F</p>	<p><b>¡Nuevo!</b></p>  <p><b>3711</b> tubo de aire a caudalímetro 1.6-1.8 r.o.1J0129684N</p>	<p><b>¡Nuevo!</b></p>  <p><b>3718</b> tubo de aire a caudalímetro 1.9Diesel r.o.</p>
<p><b>¡Nuevo!</b></p>  <p><b>4749</b> casquillo guía embrague 1.8-1.9TDi-2.3 r.o.02A141180A</p>	<p><b>¡Nuevo!</b></p>  <p><b>4772</b> leva embrague 1.4/16v-1.6/16v-1.6/8v-1.9SDi r.o.02K141709A</p>	<p><b>¡Nuevo!</b></p>  <p><b>3691</b> articulación cambio 1.9TDi hasta 5/'99 r.o.1J0711256</p>
 <p><b>4326</b> bioleta reenvío cambio velocidades (excepto reenvío por cable), r.o. 1J0711183D</p>	 <p><b>4327</b> bioleta reenvío cambio velocidades (excepto reenvío por cable), r.o. 1J0711596E</p>	 <p><b>4328</b> bioleta reenvío cambio velocidades (excepto reenvío por cable), r.o. 1J0711803C</p>

## VOLKSWAGEN GOLF-4 (1998-2004)



**5044**  
tensor correa alternador 1.9TDi  
r.o.038903315D/P

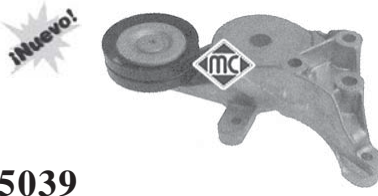

**5039**  
tensor correa alternador 1.9SDi  
r.o.038903315K

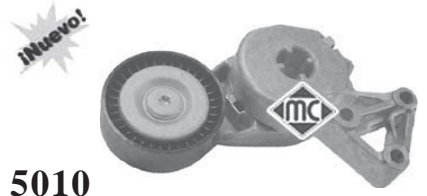

**5010**  
tensor correa alternador 1.6-1.8-2.0  
r.o.06A903315E



**4767** Ø 65 mm  
rodillo tensor correa alternador 1.9D  
r.o.038145276



**4769** Ø 75,5 mm  
rodillo tensor correa alternador 1.9D  
r.o.038145278



**4770**  
tensor correa alternador 1.4-1.6 sin a/c  
r.o.030145299F



**4922** Ø 17x70 mm  
rodillo en tensor correa alternador 1.9D  
r.o.



**4968** Ø 17x76 mm  
rodillo en tensor correa alternador  
r.o.



**5009**  
tensor correa alternador 1.4-1.6 con a/c  
r.o.032145299A

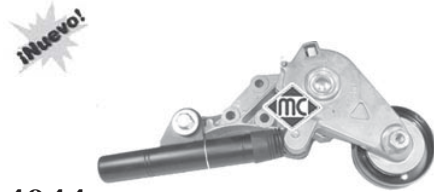

**4944**  
tensor correa alternador 1.9TDi  
r.o.038903315C



**4997** Ø 61/55 mm, H=41 mm  
polea de alternador de rueda libre  
r.o.022903119A



**4999** Ø 61/55 mm, H=41 mm  
polea de alternador de rueda libre  
r.o.038903119



**1479**  
fuelle cremallera dirección  
r.o.1J0422831B



**1921**  
kit fuelle transm. l/rda 1.4-1.6(105cv)-1.6/16v  
y 1.9SDi (Ø 26-78 mm), r.o. 1J0498203



**1297**  
kit fuelle transm. l/rda. 1.6(100-102cv)-1.8-  
2.0 y TDi de 90-100-110cv, (Ø 25-86 mm)



**1102**  
kit fuelle transmisión l/rueda TDi de 115-130-  
y 150cv (Ø 29-98 mm), r.o. 1J0498203A



**1106**  
kit fuelle transm. l/cambio 1.4-1.6(100-105cv)  
1.6/16v y 1.9SDi (Ø 27-94 mm)



**1560**  
kit fuelle transm. izqda. l/cambio 1.8-2.0-1.6  
(100-102cv) y 1.9TDi (Ø 21-100 mm)



**1637**  
kit fuelle transm. dcha. l/cambio 1.8-2.0-1.6  
(100-102cv) y 1.9TDi (Ø 21-100 mm)

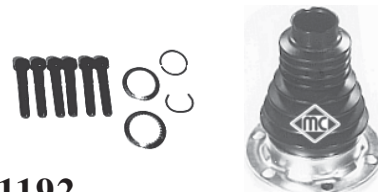

**1192**  
kit fuelle transmisión l/cambio 1.9TDi-1.8-  
-2.0 (Ø 27-100 mm), r.o. 6Q0498201A



**2308**  
kit fuelle transmisión l/cambio TDi 6 velcd.  
(Ø 22-107 mm), r.o.



VOLKSWAGEN GOLF-4 (1998-2004)



**4121**  
soporte catalizador  
r.o. 1J0253144H



**4364**  
soporte catalizador  
r.o. 1H0253144E



**4122**  
soporte presilenciador 1.4-1.6  
r.o. 1J0253144



**2426**  
soporte presilenciador 1.9TDi-1.9SDi  
r.o. 1H0253147B



**4123**  
soporte presilenciador 1.6-1.8-2.0  
r.o. 1J0253144G



**4098**  
soporte silenciador trasero  
r.o. 1J0253144J



**3575**  
juego grapas plástico alzacristales  
r.o. (no hay despiece)



**4296**  
kit reparación distribuidor Magneti-Marelli  
1.4-1.6 (casquillo sinterizado del eje rotor)



**2916**  
tapón cárter de aceite  
r.o. N90813201

**¡Nuevo!**

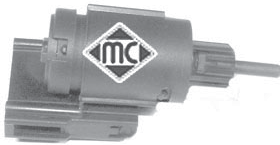

**3738**  
interruptor luz de freno (4 polos)  
r.o. 1J0945511C/D

**¡Nuevo!**



**3739**  
interruptor luz de freno (2 polos)  
r.o. 191945511A/B



**4248**  
tuerca rueda M14x1,5x27  
r.o. 8D0601139D

**¡Nuevo!**



**3708**  
tapón llenado combustible (sin llave)  
r.o. 1J0201553C



**¡Nuevo!**



**3689**  
válvula filtro gasoil  
r.o. 1J0127247A



**3621**  
tapón llenado aceite motor  
r.o. 026103485



SUSPENSION DELANTERA y SOPORTES DE MOTOR:

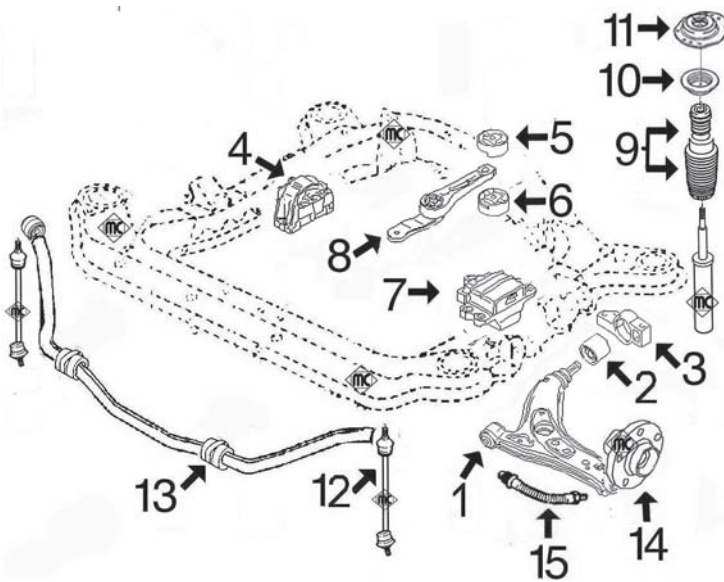





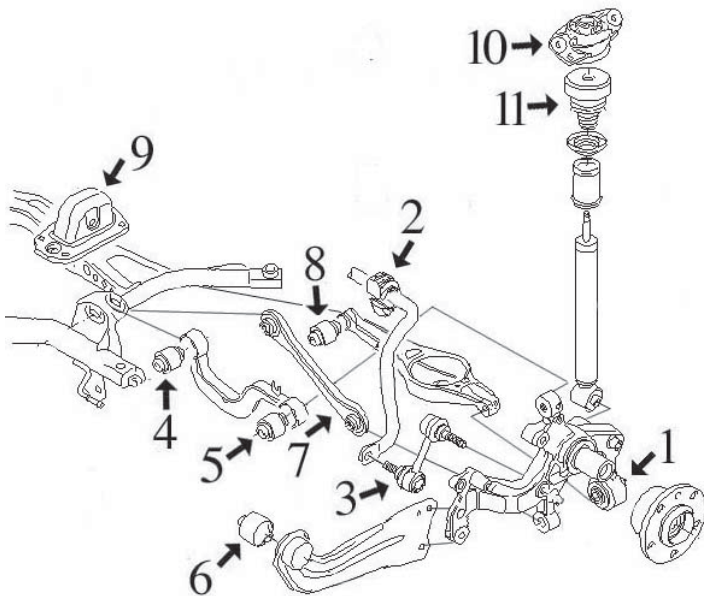













- |     |      |   |
|-----|------|---|
| 1-  | 4864 | silentbloc anterior trapecio delantero  |
| 2-  | 4691 | silentbloc posterior trapecio delantero   |
| 3-  | 4862 | silentbloc posterior trapecio delantero izquierdo completo con cuerpo de aluminio |
|     | 4863 | silentbloc posterior trapecio delantero derecho completo con cuerpo de aluminio   |
| 4-  | 4865 | soporte motor derecho 1.4-1.6-1.9TDi-2.0TDi                                       |
|     | 4866 | soporte motor derecho 1.4FSi-1.6FSi-2.0GTi  |
| 5-  | 4859 | silentbloc superior soporte trasero motor   |
| 6-  | 4860 | silentbloc inferior soporte trasero motor   |
| 7-  | 4867 | soporte motor izquierdo 1.4/16v-1.6-1.6/16v-1.9TDi-2.0FSi                         |
|     | 4868 | soporte motor izquierdo 1.9TDi (cambio manual automatizado)-2.0TDi                |
| 8-  | 4872 | bieleta soporte motor trasero 1.4-1.6 gasolina                                    |
|     | 4987 | bieleta soporte motor trasero 1.9TDi-2.0TDi-2.0 gasolina y Automáticos todos      |
| 9-  | 4765 | juego capuchón y tope poliuretano amortiguador                                    |
| 10- | 4789 | rodamiento soporte amortiguador   |
| 11- | 4871 | soporte amortiguador completo con rodamiento                                      |
| 12- | 4874 | bieleta puntal barra estabilizadora   |
| 13- | 4861 | goma barra estabilizadora   |
| 14- | n/d  | buje rueda delantera  |
| 15- | n/d  | latiguillo freno delantero  |

SUSPENSION TRASERA:



- |     |      |                                       |
|-----|------|---------------------------------------|
| 1-  | n/d  | silentbloc mangueta a brazo inferior  |
| 2-  | 4861 | goma barra estabilizadora             |
| 3-  | 4967 | bieleta puntal barra estabilizadora   |
| 4-  | n/d  | silentbloc interior brazo transversal |
| 5-  | n/d  | silentbloc exterior brazo transversal |
| 6-  | n/d  | silentbloc en brazo oscilante         |
| 7-  | n/d  | barra de acoplamiento                 |
| 8-  | n/d  | silentbloc interior brazo inferior    |
| 9-  | n/d  | soporte elástico                      |
| 10- | 4873 | soporte amortiguador trasero          |
| 11- | n/d  | tope poliuretano                      |

## VOLKSWAGEN GOLF-5 / TOURAN (2004-)

<p><b>iNuevo!</b></p>  <p><b>4691</b> silentbloc posterior trapecio delantero r.o. 1K0407183A/B</p>	<p><b>iNuevo!</b></p>  <p><b>4765</b> juego tope poliuretano y capuchón amortiguador delantero, r.o. 6N0412375A</p>	<p><b>iNuevo!</b></p>  <p><b>4789</b> rodamiento soporte amortiguador delant. r.o. 6N0412249C</p>
<p><b>iNuevo!</b></p>  <p><b>4859</b> soporte superior tirante trasero de motor r.o. 1K0199867</p>	<p><b>iNuevo!</b></p>  <p><b>4860</b> soporte inferior tirante trasero de motor r.o. 1K0199868</p>	<p><b>iNuevo!</b></p>  <p><b>4861</b> goma barra estabilizadora delantera y tras. r.o. 1K0511327AP</p>
<p><b>iNuevo!</b></p>  <p><b>4862</b> silentbloc posterior trapecio delt. <b>izquierdo</b> completo, r.o. 1K0199231G</p>	<p><b>iNuevo!</b></p>  <p><b>4863</b> silentbloc posterior trapecio delt. <b>derecho</b> completo, r.o. 1K0199232G</p>	<p><b>iNuevo!</b></p>  <p><b>4864</b> silentbloc anterior trapecio delantero r.o. 1K0407182</p>
<p><b>iNuevo!</b></p>  <p><b>4865</b> soporte motor derecho 1.4-1.6-1.9D-2.0D r.o. 1K0199262L/M</p>	<p><b>iNuevo!</b></p>  <p><b>4866</b> soporte motor derecho 1.4FSi-1.6FSi-2.0GTi r.o. 1K0199262AA/AJ/T</p>	<p><b>iNuevo!</b></p>  <p><b>4867</b> soporte motor izquierdo 1.4-1.6-1.9D-2.0D r.o. 1K0199555L/M</p>
<p><b>iNuevo!</b></p>  <p><b>4868</b> soporte motor izquierdo 2.0TDi y 1.9TDi cambio semiautomático, r.o. 1K0199555Q/T</p>	<p><b>iNuevo!</b></p>  <p><b>4871</b> soporte amortiguador delantero completo con rodamiento, r.o. 1K0412331B/C</p>	<p><b>iNuevo!</b></p>  <p><b>4872</b> soporte-tirante motor trasero 1.4-1.6 r.o. 1K0199851K</p>
<p><b>iNuevo!</b></p>  <p><b>4873</b> soporte amortiguador trasero r.o. 1K0512353G/H/J</p>	<p><b>iNuevo!</b></p>  <p><b>4874</b> bioleta puntal barra estabilizadora delantera r.o. 1K0411315D/J</p>	<p><b>iNuevo!</b></p>  <p><b>4967</b> bioleta puntal barra estabilizadora trasera r.o. 1K0505465K</p>
<p><b>iNuevo!</b></p>  <p><b>4987</b> soporte-tirante motor trasero 1.9TDi-2.0TDi-2.0 gasolina y Automáticos, r.o. 1K0199851L</p>		

VOLKSWAGEN GOLF-5 / TOURAN (2004-)

<p><b>4480</b> polea cigueñal 1.9TDi-2.0TDi r.o.03G105243</p> 	<p><b>4405</b> polea cigueñal 2.0FSi r.o.06A105243E</p> 	<p><b>4365</b> juego sujeción tapa motor TDi r.o.</p> 
<p><b>3621</b> tapón llenado aceite motor r.o.06A103485</p> 	<p><b>4793</b> varilla nivel aceite 1.4/16v-1.6/16v r.o.030115611R</p> 	<p><b>4759</b> varilla nivel aceite 1.9TDi-2.0TDi r.o.038115611B</p> 
<p><b>4355</b> guía varilla nivel aceite 1.4/16v-1.6/16v r.o.030115636A</p> 	<p><b>3597</b> pipa de agua 1.6 r.o.06A121121C</p> 	<p><b>3721</b> juego conectores manguitos radiador r.o.6Q0122291F+1J0122291</p> 
<p><b>3677</b> tapón botella de expansión r.o.03B121321</p> 	<p><b>4749</b> casquillo guía embrague con retén r.o.02A141180A</p> 	<p><b>4770</b> tensor correa alternador 1.4 con aire ac. r.o.030145299F</p> 
<p><b>1479</b> fuelle cremallera dirección r.o.1J0422831B</p> 	<p><b>1921</b> kit fuelle transmisión lado rueda bocas de Ø 26-78 mm, r.o. 1J0498203</p> 	<p><b>1297</b> kit fuelle transmisión lado rueda bocas de Ø 25-86 mm, r.o. 1H0407285A</p> 
<p><b>1102</b> kit fuelle transmisión lado /rueda bocas de Ø 29-98 mm, r.o. 1K0498203A</p> 	<p><b>1106</b> kit fuelle transmisión lado cambio bocas de Ø 27-94 mm, r.o. 1K0498201B</p> 	<p><b>1192</b> kit fuelle transmisión lado cambio bocas de Ø 27-100 mm, r.o. 1K0498201</p> 
<p><b>2308</b> kit fuelle transmisión lado cambio bocas de Ø 27-100 mm, r.o. 1K0498201A</p> 	<p><b>3708</b> tapón llenado combustible (sin llave) r.o.1J0201553C</p> 	

VOLKSWAGEN GOLF-5 / TOURAN (2004-)

<p><b>¡Nuevo!</b></p>  <p><b>4767</b> Ø 65 mm rodillo tensor correa alternador r.o.038145276</p>	<p><b>¡Nuevo!</b></p>  <p><b>4769</b> Ø 75,5 mm rodillo tensor correa alternador 5 canales r.o.038145278</p>	<p><b>¡Nuevo!</b></p>  <p><b>4922</b> Ø 17x70 mm rodillo en tensor correa alternador r.o.</p>
<p><b>¡Nuevo!</b></p>  <p><b>4968</b> Ø 17x76 mm rodillo en tensor correa alternador r.o.</p>	<p><b>¡Nuevo!</b></p>  <p><b>3738</b> interruptor luz de freno (4 polos) r.o.N90813201</p>	 <p><b>2916</b> tapón cárter de aceite con junta r.o.</p>
<p><b>¡Nuevo!</b></p>  <p><b>4770</b> tensor correa alternador 1.4 r.o.030145299F</p>	<p><b>¡Nuevo!</b></p>  <p><b>5010</b> tensor correa alternador 1.6-1.8-2.0 r.o.06A903315E</p>	<p><b>¡Nuevo!</b></p>  <p><b>4997</b> Ø 61/55 mm, H=41 mm polea de alternador de rueda libre r.o.022903119A</p>
<p><b>¡Nuevo!</b></p>  <p><b>4869</b> soporte silenciador trasero r.o.1K0253144AH</p>	<p><b>¡Nuevo!</b></p>  <p><b>4870</b> soporte escape r.o.1K0253144AP</p>	 <p><b>2766</b> soporte escape r.o.8D0253147E</p>
 <p><b>4248</b> tuerca rueda M14x1,5x27 r.o.8D0601139D</p>		



## CANALIZACIONES DE AGUA

**AROSA** 1.0 motores AER-AHT-ALL-ALD  
1.4 motores AEX-AKK-ANW-APQ  
1.4 motores 16v. AFK-AUB-AQQ

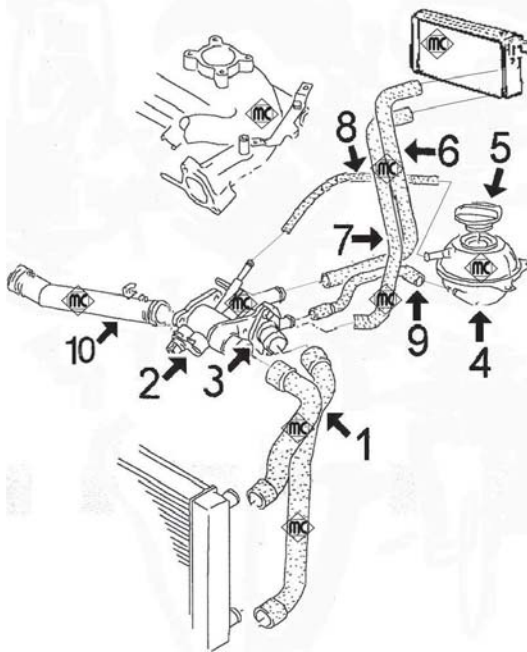

- 1- 8797 mgto superior e inferior radiador (ensamblados)
- 2- 3615 cuerpo de termostato completo con termostato, tapa y accesorios
- 3- 3592 kit de termostato completo con tapa y junta  
3541 tapa de termostato
- 4- 3610 botella de expansión
- 5- 3676 tapón botella de expansión
- 6- 8803 mgto entrada agua a calefactor
- 7- 8806 mgto retorno agua de calefactor
- 8- 116 mgto sobrante de botella a termostato: cortar de rollo MC-116 Ø8x14 mm, long. aprox. 350 mm
- 9- 8798 mgto de cuerpo termostato a botella
- 10- 3625 tubo de agua (plástico) con juntas tóricas





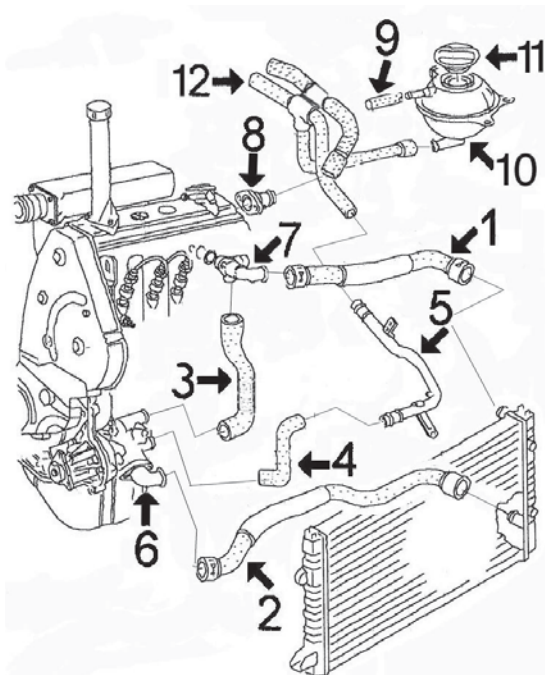















8811 mgto desvaporizador

**AROSA** 1.7 Diesel motor AKU "SDi"

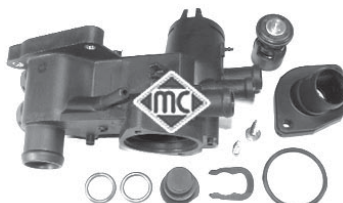

- 1- 8804 mgto superior radiador
- 2- 8805 mgto inferior radiador
- 3- 8808 mgto de bomba agua a racor en culata
- 4- 8810 mgto de bomba agua a tubo metálico
- 5- 3157 tubo de agua metálico
- 6- 3528 tapa de termostato
- 7- 3585 racor en culata
- 8- 3517 boquilla lateral en culata
- 9- 116 mgto sobrante de botella: cortar de rollo MC-116 Ø8x14 mm, long. aprox. 400 mm
- 10- 3610 botella de expansión
- 11- 3676 tapón botella de expansión
- 12- 8814 mgto doble de calefactor

## VOLKSWAGEN LUPO

 <p><b>8797</b> mgto superior/inferior radiador 1.0-1.4 r.o.</p>	 <p><b>8798</b> mgto de cuerpo termostato a botella 1.0-1.4 r.o.</p>	 <p><b>8803</b> mgto entrada calefactor 1.0-1.4 r.o.</p>
 <p><b>8804</b> mgto superior radiador 1.7 Diesel r.o.</p>	 <p><b>8805</b> mgto inferior radiador 1.7 Diesel r.o.</p>	 <p><b>8806</b> mgto retorno calefactor 1.0-1.4 r.o.</p>
 <p><b>8808</b> mgto de bomba agua a racor en culata 1.7 D r.o.</p>	 <p><b>8810</b> mgto de bomba agua a tubo metálico 1.7 D r.o.</p>	 <p><b>8811</b> mgto desvaporizador 1.0-1.4 r.o.</p>
 <p><b>8814</b> mgto doble de calefactor 1.7 Diesel r.o.</p>	 <p><b>3157</b> tubo de agua metálico 1.7 Diesel r.o.6N0121065G</p>	 <p><b>3517</b> boquilla en culata (lateral) 1.7 Diesel r.o.026121144E</p>
 <p><b>3528</b> tapa de termostato r.o.030121121B</p>	 <p><b>3541</b> tapa de termostato 1.0-1.4 r.o.032121121B/J</p>	 <p><b>3585</b> racor en culata (frontal) 1.7 Diesel r.o.</p>
 <p><b>3592</b> kit completo de termostato, tapa y junta 1.0-1.4,r.o.032121121J+032121110B</p>	 <p><b>3615</b> cuerpo de termostato 1.0-1.4 completo <b>con termostato</b>,r.o.032121111N</p>	 <p><b>3625</b> tubo de agua (plástico) 1.4 con juntas tóricas,r.o.032121065D</p>
 <p><b>3540</b> jgo. tapón, junta y pasador para cubrir tomas para sensores en tapas de agua</p>	 <p><b>3610</b> botella de expansión r.o.6N0121407C</p>	 <p><b>3676</b> tapón botella de expansión r.o.1H0121321D</p>

SUSPENSION DELANTERA y SOPORTES DE MOTOR

1.0 - 1.4 - 1.4/16v - 1.7D-SDi:

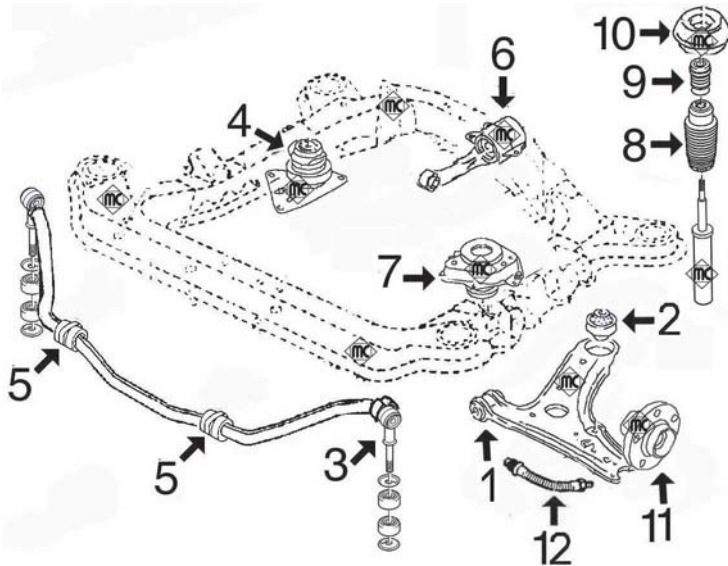

- 1- 2859 silentbloc anterior trapecio delantero
- 2- 2858 silentbloc posterior trapecio delantero
- 3- 2853 bieleta puntal barra estabilizadora completa
- 4- 4095 soporte motor derecho 1.0-1.4 (gasolina)
- 4317 soporte motor derecho 1.7D
- 5- 4318 goma para barra estabilizadora de 18 mm
- 4319 goma para barra estabilizadora de 20 mm
- 6- 4169 soporte motor trasero
- 7- 4096 soporte motor izquierdo 1.0-1.4
- 4415 soporte motor izquierdo 1.7D-1.7SDi
- 8- 4324 capuchón amortiguador delantero
- 9- 4298 tope poliuretano amortiguador delantero
- 10- 2877 soporte superior amortiguador delantero completo con rodamiento
- 11- 90034 buje rueda delantera
- 12- 96128 latiguillo freno delantero (410 mm)

1.4 TDi (desde 10/'99-)

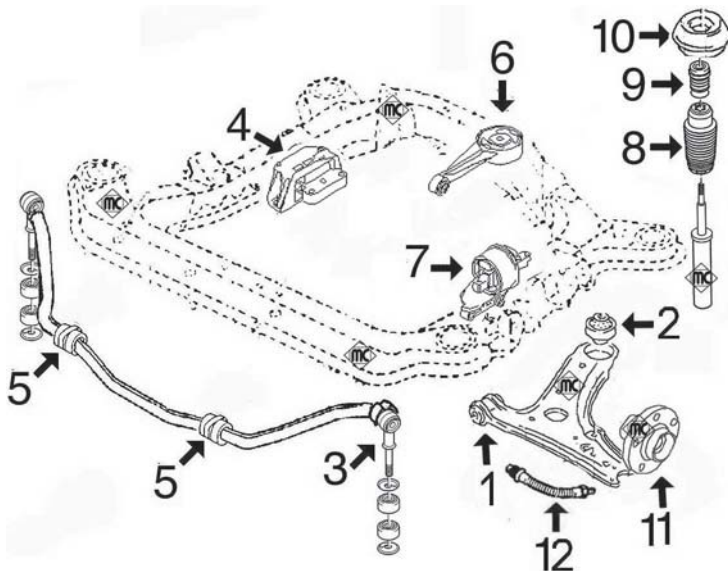

- 1- 2859 silentbloc anterior trapecio delantero
- 2- 2858 silentbloc posterior trapecio delantero
- 3- 2853 bieleta puntal barra estabilizadora completa
- 4- 4790 soporte motor derecho
- 5- 4318 goma para barra estabilizadora de Ø 18 mm
- 4319 goma para barra estabilizadora de Ø 20 mm
- 6- 4784 soporte motor trasero
- 7- 4783 soporte motor izquierdo
- 8- 4324 capuchón amortiguador delantero
- 9- 4298 tope poliuretano amortiguador delantero
- 10- 2877 soporte superior amortiguador delantero completo con rodamiento
- 11- 90034 buje de rueda delantera
- 12- 96128 latiguillo freno delantero (410 mm)

SUSPENSION TRASERA:

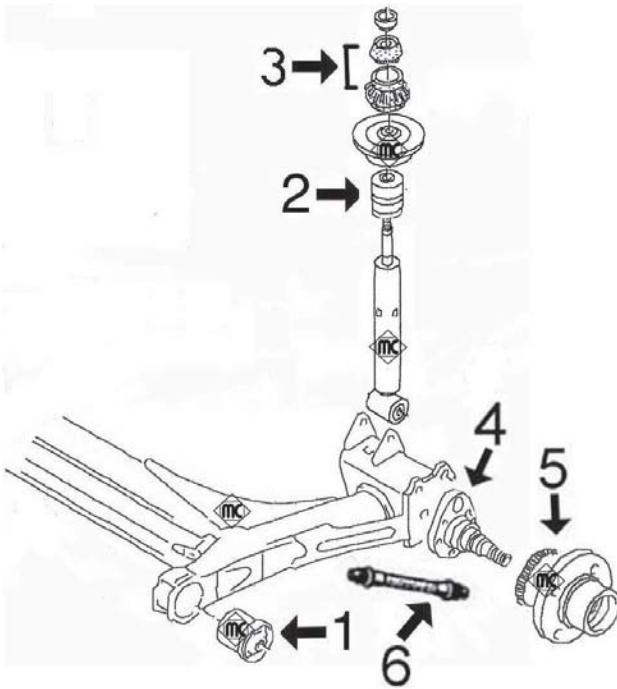

- 1- 2839 silentbloc puente trasero
- 2- 4299 tope poliuretano amortiguador trasero
- 3- 4320 jgo. soportes amortiguador trasero
- 4- 90539 mangueta rueda trasera izquierda hasta 5/'98  
90540 mangueta rueda trasera derecha hasta 5/'98
- 5- 90525 buje rueda trasera con rodamiento desde 5/'98
- 6- 96014 latiguillo freno trasero (165 mm)



**2839**  
silentbloc puente trasero  
r.o. 6N0501541D



**2853**  
bieleta puntal barra estabilizadora **completa**  
r.o. 6N0411315



**2858**  
silentbloc posterior trapecio delantero  
r.o. 6N0407181



**2859**  
silentbloc anterior trapecio delantero  
r.o. no hay despiece, va con el brazo



**2877**  
soporte amortiguador delantero completo  
**con rodamiento** r.o. 6N0412331A+1J0412249



**4095**  
soporte motor derecho 1.0 - 1.4  
r.o. 6N0199262A



**4096**  
soporte motor izquierdo 1.0-1.4  
r.o. 6N0199555G/C/AA



**4169**  
soporte motor trasero  
r.o. 6N0199851AG























**4298**  
tope poliuretano amortiguador delantero  
r.o. 1H0412303B

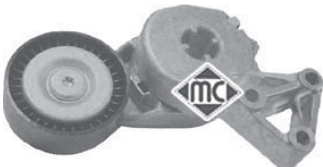

## VOLKSWAGEN LUPO

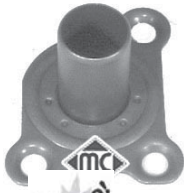
 <p><b>4299</b> tope poliuretano amortiguador trasero r.o. 6N0512131A</p>	 <p><b>4317</b> soporte motor derecho 1.7 Diesel r.o. 6N0199262K</p>	 <p><b>4318</b> goma para barra estabilizadora de 18 mm r.o. 6X0411313</p>
 <p><b>4319</b> goma para barra estabilizadora de 20 mm r.o. 6X0411313A</p>	 <p><b>4320</b> juego soportes amortiguador trasero r.o. 191512333+191512335</p>	 <p><b>4324</b> fuelle amortiguador delantero r.o. 357413175A</p>
 <p><b>4415</b> soporte motor izquierdo 1.7D-1.7SDi r.o. 6N0199555H</p>	 <p><b>4783</b> soporte motor izquierdo 1.4TDi r.o. 6N0199543F</p>	 <p><b>4784</b> soporte motor trasero 1.4TDi r.o. 6N0199851AF</p>
 <p><b>4790</b> soporte motor derecho 1.4TDi r.o. 6N0199167BF</p>	 <p><b>90034</b> buje rueda delantera r.o. 6N0407613</p>	 <p><b>90539</b> mangueta rueda tras <b>izquierda</b> hasta 5/98 r.o. 333501117A</p>
 <p><b>90540</b> mangueta rueda trasera <b>derecha</b> hasta 5/98 r.o. 333501118A</p>	 <p><b>90525</b> buje rueda trasera <b>con rodamiento</b> desde 5/98, r.o. 6X0598477</p>	 <p><b>96128</b> latiguillo de freno delantero (410 mm) r.o. 6N0611701A/B</p>
 <p><b>96014</b> latiguillo freno trasero (165 mm) r.o. 6X0611775</p>		

# VOLKSWAGEN LUPO

<p><b>¡Nuevo!</b></p>  <p><b>4492</b> polea cigueñal 1.4TDi r.o. 045105243B-045105243</p>	<p><b>¡Nuevo!</b></p>  <p><b>4495</b> polea cigueñal 1.7D/SDi r.o. 028105243AC</p>	
 <p><b>4355</b> guía varilla nivel aceite 1.0-1.4-1.4/16v r.o. 030115636A</p>	<p><b>¡Nuevo!</b></p>  <p><b>4793</b> varilla nivel aceite 1.0-1.4-1.4/16v r.o.</p>	<p><b>¡Nuevo!</b></p>  <p><b>4794</b> varilla nivel aceite 1.4TDi r.o.</p>
<p><b>¡Nuevo!</b></p>  <p><b>4791</b> varilla nivel aceite 1.7D/SDi r.o. 030115636A</p>	 <p><b>3621</b> tapón llenado aceite motor r.o. 026103485</p>	<p><b>¡Nuevo!</b></p>  <p><b>4770</b> tensor correa alternador 1.0-1.4-1.4/16v r.o. 030145299F</p>
 <p><b>4767</b> rodillo tensor correa alternador 1.0-50CV r.o. 038145276</p>	<p><b>¡Nuevo!</b></p>  <p><b>4771</b> tensor correa alternador 1.0-50CV-1.7D/SDi r.o. 028145278M</p>	<p><b>¡Nuevo!</b></p>  <p><b>4923</b> tensor correa alternador 1.7D/SDi r.o. 028903315P</p>
<p><b>¡Nuevo!</b></p>  <p><b>5010</b> tensor correa alternador 1.4TDi r.o. 06A903315E</p>	<p><b>¡Nuevo!</b></p>  <p><b>4997</b>      Ø 61/55 mm, H=45 mm polea de alternador de rueda libre r.o. 022903119A</p>	<p><b>¡Nuevo!</b></p>  <p><b>5000</b>      Ø 61/55 mm, H=37 mm polea de alternador de rueda libre r.o. 038903119Q</p>
 <p><b>4353</b> bieleta mando cambio 1.7 Diesel r.o. 6N0711575A</p>	<p><b>¡Nuevo!</b></p>  <p><b>4903</b> casquillo guía eje .0-1.4-1.4/16v-1.7D r.o. 085141181</p>	<p><b>¡Nuevo!</b></p>  <p><b>4749</b> casquillo guía embrague 1.4TDi r.o. 02A141180A</p>
<p><b>¡Nuevo!</b></p>  <p><b>3672</b> válvula filtro gasoil hasta 5/00 r.o. 191127247A</p>	<p><b>¡Nuevo!</b></p>  <p><b>3689</b> válvula filtro gasoil desde 5/00 r.o. 1J0127247-1J0127247A</p>	 <p><b>4296</b> kit reparación distribuidor Magneti-Marelli (casquillo sinterizado del eje rotor)</p>

## VOLKSWAGEN LUPO

<p><b>¡Nuevo!</b></p>  <p><b>3738</b> conmutador luz de freno (4 polos) salvo TDi r.o. 1J0945511D/C</p>	 <p><b>1436</b> fuelle cremallera dirección salvo 1.4TDi r.o. 6N0419831</p>	 <p><b>1357</b> fuelle cremallera dirección 1.4TDi r.o. 6N0422831</p>
 <p><b>1921</b> kit fuelle transmisión lado rueda r.o. 6N0498203</p>	 <p><b>1632</b> kit fuelle transmisión lado cambio r.o. 6N0498201</p>	 <p><b>4365</b> jgo. tornillo sujeción tapa cubremotor r.o. 028103665+028103937+028103638G</p>
 <p><b>674</b> tapón de cárter M-14x150 r.o.</p>	 <p><b>2426</b> soporte delantero tubo de escape r.o. 1H0253147B</p>	 <p><b>4273</b> soporte trasero tubo de escape r.o.</p>
 <p><b>792</b> tornillo rueda M-12x150x23,5 r.o. 3A0601139</p>	 <p><b>864</b> cubrepedal freno y embrague r.o. 321721173</p>	

**VOLKSWAGEN PASSAT mod. '82 (1982 - 1988)**



**7628**  
mgto superior radiador salvo 5 cilindros  
r.o.321101101J



**7629**  
mgto inferior radiador salvo 5 cilindros  
r.o.321101051L



**8185**  
mgto de bomba a tubo metálico 1.6-1.8  
r.o.026121063B/M



**7715**  
mgto de bomba a racor en culata 1.6-1.8  
r.o.026121053G



**7917**  
mgto de bomba a brida en culata Diesel  
r.o.068121053Q



**3517**  
boquilla en culata a tubo de calefacción  
r.o.026121145E



**3574**  
tapón botella de expansión  
r.o.443121321



**803**  
silentbloc trapecio delantero (sin dirección  
asistida), r.o. 857407181



**2697**  
silentbloc trapecio delantero (con dirección  
asistida), r.o. 811407181A



**801**  
goma puntal barra estabilizadora  
r.o.823411313A



**923**                      **rodamiento Ø 14 mm**  
soporte amortiguador delantero  
r.o.811412323C



**546**  
soporte de motor salvo 5 cilindros  
r.o.823199381B



**2485**  
soporte de motor 5 cilindros  
r.o.443199381/C-443199379D



**718**  
soporte cambio  
r.o.811399151A



**1359**  
kit rep transmisión l/rueda 1.6 y Diesel  
r.o.191498203C



**1575**  
kit rep transmisión l/rueda 5 cilindros  
r.o.191498203

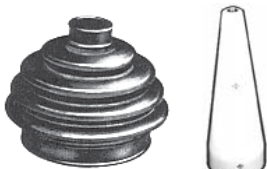

**1359-E**                      **para montar con cono**  
kit rep transmisión l/rueda 1.6 y Diesel  
r.o.191498203C

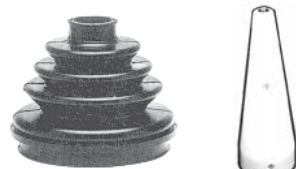

**1575-E**                      **para montar con cono**  
kit rep transmisión l/rueda 5 cilindros  
r.o.191498203



**1529**  
kit fuelle transmisión l/cambio Ø 100 mm  
r.o.



VOLKSWAGEN PASSAT mod. '82 (1982 - 1988)



**1573**  
fuelle cremallera dirección  
r.o.811419831B



**2696**  
soporte carburador 1.6  
r.o.050129761E



**2880**  
soporte carburador 1.6-1.8  
r.o.026129761E



**497**  
soporte escape  
r.o.803253147



**098**  
soporte escape  
r.o.191253147A



**2609**  
tuerca autoblocante buje delantero  
r.o.191407643

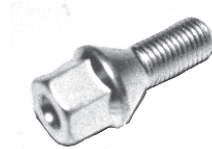

**792**  
tuerca rueda  
r.o.3A0601139



**864**  
cubrepedal freno y embrague desde '85  
r.o.321721173



**674**  
tapón cárter de aceite  
r.o.113115193

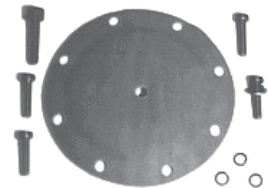

**832**  
jgo reparación membrana depresor Diesel  
r.o.068198821A



**90542**  
mangueta rueda trasera **derecha** freno de disco, r.o. 333501118



**90516**  
mangueta rueda trasera con freno de tambor  
r.o.357501117



**90541**  
mangueta rueda trasera **izquierda** freno de disco, r.o. 333501117

# VOLKSWAGEN PASSAT mod. '88 (1988-1996)

## PASSAT 1.6 - 1.8i

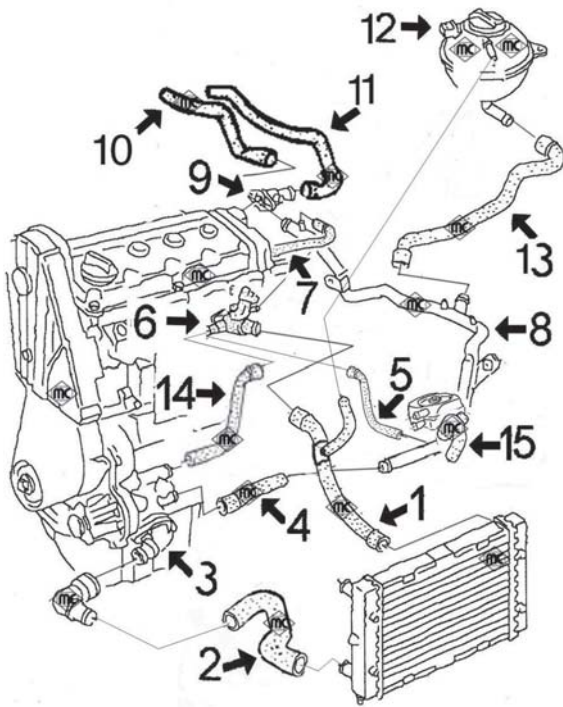

- 1- 8456 mgto superior radiador 1.6-1.8
- 2- 7343 mgto inferior radiador
- 3- 3536 tapa de termostato hasta '93  
3537 tapa de termostato desde '93
- 4- 3667 tapa de termostato desde '93 completa con codo
- 7993 mgto de bomba de agua a tubo metálico hasta '93
- 8386 mgto de bomba a tubo metálico desde '93
- 5- 8193 mgto de brida en culata a intercambiador 1.8
- 6- 3505 brida en culata conexión mgto 1.8 hasta '90
- 3535 brida en culata conexión mgto 1.6-1.8 hasta '94
- 3582 brida en culata conexión mgto 1.8-16v.
- 3522 brida en culata conexión mgto 1.8 desde '94
- 7- 8381 juego de mgto de tubo a colector admisión 1.6
- 8391 mgto de tubo metálico a colector admisión 1.8
- 8- 3079 tubo de agua metálico
- 9- 3517 boquilla en culata 1.6 hasta '94-1.8-1.8/16v
- 3589 boquilla en culata 1.6 desde '94
- 10- 8051 mgto de tubo metálico a calefactor
- 11- 8050 mgto de culata a calefactor
- 12- 3504 botella de expansión con sensor
- 3506 tapón botella de expansión
- 13- 8378 mgto de botella a tubo metálico
- 14- 7715 mgto de bomba a brida en culata hasta '93
- 8383 mgto de bomba a brida en culata desde '93
- 15- 7994 mgto de tubo metálico a intercambiador 1.8
  
- 8227 mgto desvaporizador 1.6 sin catalizador
- 8225 mgto desvaporizador 1.8 sin catalizador
- 8224 mgto desvaporizador 1.8 con catalizador

## PASSAT 1.9 Diesel-TD-TDi 2.0 y 2.0-16v.

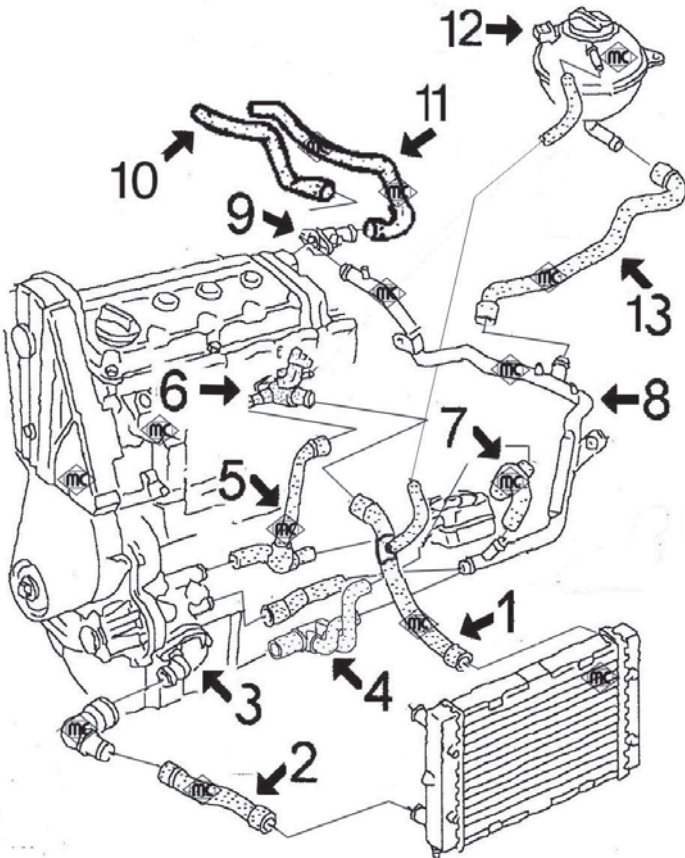

- 1- n/d mgto superior radiador 2.0 con aire acond.
- 8456 mgto superior radiador Diesel y 2.0 sin aire acondicionado y automáticos
- 7923 mgto superior radiador Diesel con aire acondicionado
- n/d mgto superior radiador TD y 16v
- 2- 8455 mgto inferior radiador Diesel y TurboD sin aire acondicionado y 2.0 y 16v todos
- n/d mgto inferior radiador Diesel y TD con aire ac.
- 3- 3536 tapa de termostato hasta '93
- 3537 tapa de termostato desde '93
- 3667 tapa de termostato desde '93 completa con codo
- 4- 7993 mgto de bomba agua a tubo metálico hasta '93
- 7922 mgto de bomba a tubo metálico G60 (3 vias)
- 8384 mgto de bomba a tubo e intercambiador desde '93
- 5- 7987 mgto de bomba de agua a racor en culata y a intercambiador filtro de aceite, Diesel y TD
- 8394 mgto de bomba a racor e intercambiador 2.0
- 7920 mgto de bomba de agua a brida en culata 16v
- 8382 mgto de bomba agua a tapa en culata TD-TDi d/'93
- 8414 mgto de bomba agua a tapa en culata 2.0-16v d/'93
- 6- 3527 brida en culata conexión mgto Diesel y TD
- 3542 brida en culata conexión mgto TDi
- 3535 brida en culata conexión mgto 2.0 hasta '94
- 3522 brida en culata conexión mgto 2.0 desde '95
- 7- 7994 mgto de tubo metálico a intercambiador filtro de aceite hasta '93
- 8- 3083 tubo de agua metálico 2.0-1.9D-1.9TD hasta '93
- 3084 tubo de agua metálico 2.0-1.9D-1.9TD desde '93
- 3094 tubo de agua metálico TDi
- 9- 3517 boquilla en culata 1.9D-TD-TDi-2.0
- 3583 boquilla en culata 2.0-16v.
- 10- 8051 mgto de tubo metálico a calefactor
- 11- 8050 mgto de bloque motor a calefactor
- 12- 3504 botella de expansión
- 3506 tapón botella de expansión
- 13- 8378 mgto de botella a tubo metálico
  
- 8385 mgto desvaporizador Diesel
- 8228 mgto desvaporizador 2.0 gasolina hasta 9/94
- 8853 mgto desvaporizador 2.0 gasolina desde 10/'94
- 8229 mgto desvaporizador 2.0 gasolina

TUBOS DESVAPORIZADORES 1.9D - TD - TDi - SDi:

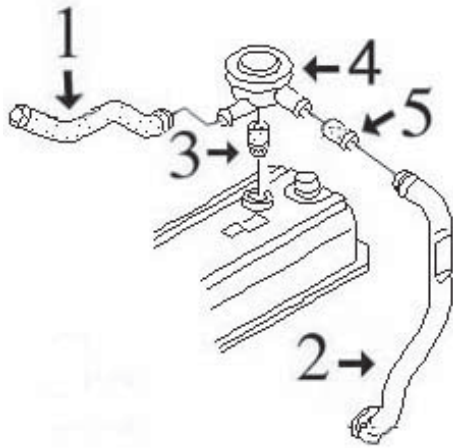

- 1- 8895 mgto de válvula desvaporizadora 1.9TDi
- 8085 mgto de válvula desvaporizadora 1.9D-TD
- 2- 3644 tubo plástico de válvula a cárter
- 3- 2669 junta válvula desvaporizadora
- 4- 3719 válvula desvaporizadora
- 5- 8085 mgto desvaporizador 1.9D-TD (no TDi!)

 <p><b>7343</b> mgto inferior radiador 1.6-1.8 sin aire ac. r.o.357121051B</p>	 <p><b>7715</b> mgto de bomba a racor en culata 1.6-1.8 r.o.026121053G</p>	 <p><b>7920</b> mgto de bomba a brida en culata 2.0 r.o.027121053B</p>
 <p><b>7922</b> mgto de bomba a tubo e intercamb. G60 r.o.068121058C</p>	 <p><b>7923</b> mgto superior radiador Diesel con aire ac. r.o.357121101C</p>	 <p><b>7987</b> mgto de bomba a brida en culata Diesel y TD, r.o.068121053P</p>
 <p><b>7993</b> mgto de bomba a tubo metálico salvo G60 r.o.068121063M</p>	 <p><b>7994</b> mgto de tubo metálico a intercambiador r.o.037121058A</p>	 <p><b>8050</b> mgto de culata a calefactor r.o.191819371H</p>
 <p><b>8051</b> mgto de tubo metálico a calefactor d/ '88 r.o.191819373D</p>	 <p><b>8193</b> mgto de brida en culata a intercambiador 1.8, r.o.027121096A</p>	























VOLKSWAGEN PASSAT mod. '88 (1988-1996)

 <p><b>8224</b> mgto desvaporizador 1.8 con catalizador r.o.051103493A</p>	 <p><b>8225</b> mgto desvaporizador 1.8 sin catalizador r.o.051103493</p>	 <p><b>8227</b> mgto desvaporizador 1.6 sin catalizador r.o.026103493A</p>
 <p><b>8228</b> mgto desvaporizador 2.0 r.o.037103493AB-037103211</p>	 <p><b>8229</b> mgto desvaporizador 2.0 r.o.037103493P</p>	 <p><b>8378</b> mgto de tubo metálico a botella expansión r.o.357121109</p>
 <p><b>8381</b> juego mgts colector 1.6 r.o.026121062C+037121057</p>	 <p><b>8382</b> mgto de bomba a brida en culata Diesel r.o.028151053Q/S/P/L</p>	 <p><b>8383</b> mgto de bomba a brida en culata 1.6-1.8 con catalizador, r.o.037121053H</p>
 <p><b>8384</b> mgto de bomba a tubo e intercambiador r.o.037122058-037121058B-037122058B</p>	 <p><b>8385</b> mgto desvaporizador Diesel r.o.028103493E</p>	 <p><b>8386</b> mgto de bomba a tubo de agua metálico 1.8, r.o.037121063A</p>
 <p><b>8391</b> mgto de tubo metálico a colector 1.8 r.o.051121056</p>	 <p><b>8394</b> mgto de bomba a brida en culata 2.0 r.o.037121053G</p>	 <p><b>8414</b> mgto de bomba a brida en culata 2.0-16v r.o.037121053K</p>
 <p><b>8455</b> mgto inferior radiador D-TD y 2.0 sin aire acondicionado, r.o.357121051A</p>	 <p><b>8456</b> mgto superior radiador 1.6-1.8-D y auto- máticos, r.o.357121101A-357121101B</p>	 <p><b>8853</b> mgto desvaporizador 2.0 gasolina (desde 10/'94), r.o.</p>
 <p><b>8895</b> mgto desvaporizador 1.9TDi r.o.028103493S</p>		



VOLKSWAGEN PASSAT mod. '88 (1988-1996)

 <p><b>3079</b> tubo de agua metálico 1.6-1.8 r.o.027121065C</p>	 <p><b>3083</b> tubo de agua metálico D-TD-2.0 y 16v r.o.027121065D/E</p>	 <p><b>3084</b> tubo de agua metálico 1.8 y Diesel desde '93,r.o.037121065K/L/G/H</p>
 <p><b>3094</b> tubo de agua metálico TDi r.o.028121065K-028121065T</p>	 <p><b>3504</b> botella de expansión con sensor de nivel r.o.357121407A</p>	 <p><b>3506</b> tapón botella de expansión r.o.357121321A</p>
 <p><b>3522</b> brida en culata (frontal) 1.8-2.0 desde '95 r.o.037121132E</p>	 <p><b>3527</b> brida en culata (frontal) D-TD (salvo TDi) r.o.068121133AB/AE</p>	 <p><b>3535</b> brida en culata (frontal) 1.6-1.8 desde '90 r.o.037121132B</p>
 <p><b>3582</b> brida en culata (frontal) 1.8-2.0 motores KR-9A(100Kw),r.o.027121133E</p>	 <p><b>3517</b> boquilla en culata (lateral) todos salvo motor KR-9A,r.o.037121145-026121145E</p>	
 <p><b>3505</b> brida en culata (frontal) 1.8 hasta '90 r.o.037121133C</p>	 <p><b>3542</b> brida en culata (frontal) 1.9 TDi r.o.028121132-028121132A-028121133B</p>	 <p><b>3589</b> brida en culata (lateral) 1.6 desde '94 r.o.037121145F-037121144H</p>
 <p><b>3583</b> brida en culata (lateral) motores 1.8-2.0 KR-9A(100Kw),r.o.027121145B</p>	 <p><b>3536</b> tapa de termostato hasta '93 r.o.055121121F</p>	 <p><b>3537</b> tapa de termostato desde '93 r.o.037121121A</p>
 <p><b>3540</b> kit tapón cierre alojamiento sensores r.o.357121140+032121142+N90316802</p>	 <p><b>3644</b> tubo desvaporizador 1.9D-TD-TDi r.o.028103491J</p>	 <p><b>3667</b> tapa de termostato 1.6-1.8-2.0-D-TD-TDi completa con codo,037121121A+037121619</p>

# VOLKSWAGEN PASSAT mod. '88 (1988-1996)

  <p><b>3719</b> válvula desvaporizadora r.o.028129101D</p>	 <p><b>2669</b> junta válvula desvaporizadora r.o.028103500</p>	  <p><b>8377</b> mgto depresor de servofreno r.o.321611939E</p>
--	--	---

## SUSPENSION DELANTERA y SOPORTES DE MOTOR:

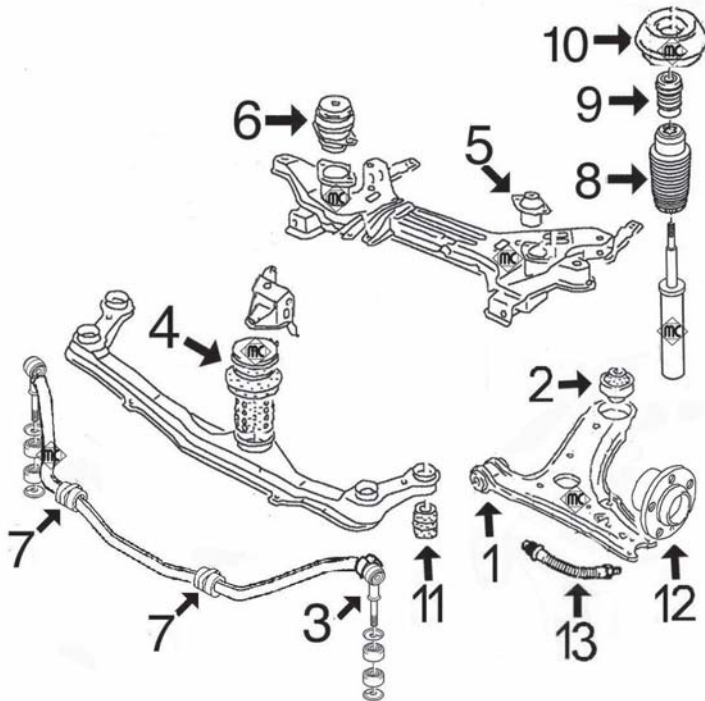

- 1- 542 silentbloc posterior trapecio delantero
- 2- 543 silentbloc anterior trapecio delantero
- 2822 casquillo eje silentbloc anterior
- 3- 4345 bieleta puntal barra estabilizadora Ø 21 mm
- 4142 bieleta puntal barra estabilizadora Ø 23 mm
- 4- 848 soporte de motor delantero 1.9D-TD hasta '94
- 849 soporte de motor delantero 1.6/1.8/2.0 hasta '94
- 2685 soporte de motor delantero V6 y todos desde '95
- 5- 987 soporte de motor trasero izquierdo 1.6-1.8-D-TD
- 4366 soporte de motor trasero izquierdo 2.0 y 16v
- 6- 847 soporte de motor trasero derecho hasta '94 salvo 2.0 y 16v.
- 4127 soporte motor trasero derecho 2.0, 16v. y 2.8 hasta '94
- 2686 soporte de motor trasero derecho todos desde '95
- 7- n/d goma barra estabilizadora
- 8- 4324 capuchón amortiguador desde '95
- 9- 712 tope de amortiguador hasta '94 (goma)
- 4254 tope de amortiguador desde '95 (poliuretano)
- 10- 896 soporte amortiguador delantero salvo V6 hasta '94 (con rodamiento)
- 2812 soporte amortiguador delantero V6 y todos desde '95 (con rodamiento)
- 4128 rodamiento soporte amortiguador desde '95
- 11- 2444 silentbloc soporte travesa delantera
- 12- 90073 buje rueda delantera sin ABS hasta '93
- 90074 buje rueda delantera con ABS hasta '93
- 90035 buje rueda delantera desde '93 salvo 2.0-2.8
- 90048 buje rueda delantera 2.0-2.8 desde '93
- 13- 96192 latiguillo freno delantero (370 mm)



**542**  
silentbloc posterior trapecio delantero  
r.o.357407182



**543**  
silentbloc anterior trapecio delantero  
r.o.357407181



**2822**  
casquillo eje silentbloc anterior trapecio  
r.o.191407190A

## VOLKSWAGEN PASSAT mod. '88 (1988-1996)

 <p><b>712</b> tope amortiguador delantero hasta '94 r.o.357412303E</p>	 <p><b>4254</b> tope amortiguador delantero desde '95 r.o.357412303F</p>	 <p><b>4324</b> capuchón amortiguador delantero d/ '95 r.o.357413175A</p>
 <p><b>4345</b> bieleta puntal para barra estab. de Ø 21 mm r.o.357411315C</p>	 <p><b>4142</b> bieleta puntal para barra estab. de Ø 23 mm r.o.357411315D</p>	 <p><b>4128</b> rodamiento para soporte amortiguador desde '95, r.o. 1J0412249</p>
 <p><b>896</b> con rodamiento soporte amortiguador delantero salvo V6 y y "variant" hasat '94, r.o. 357412329</p>	 <p><b>2812</b> soporte amortiguador delt. V6 y "variant" y todos desde '95, r.o. 357412331A</p>	 <p><b>2444</b> silentbloc soporte traviesa delantera r.o.191999233</p>
 <p><b>987</b> soporte trasero izquierdo de motor hasta '94 r.o.191199402A</p>	 <p><b>848</b> soporte delantero de motor D-TD hasta '94 r.o.357199279B</p>	 <p><b>849</b> soporte delantero de motor 1.6-1.8-2.0 hasta '94, r.o. 191199279E</p>
 <p><b>847</b> soporte trasero derecho de motor salvo 2.0, 16v. y V6, r.o. 191199262A</p>	 <p><b>4127</b> soporte trasero derecho motor 2.0, 16v y 2.8 r.o.535199262</p>	 <p><b>2685</b> soporte motor delantero desde '95 r.o.1H0199609D/K</p>
 <p><b>2686</b> soporte motor izquierdo desde '95 r.o.1H0199262B</p>	 <p><b>4366</b> soporte motor izquierdo 2.0, 16v. y autom. r.o.357199381C</p>	 <p><b>1642</b> kit rep. transmisión l/rueda desde '88 r.o.357498203A</p>
 <p><b>1642-E</b> para montar con cono kit rep. transmisión l/rueda desde '88 r.o.357498203A</p>	 <p><b>1560</b> kit rep. transmisión izqda. l/cambio d/'88 r.o.321407283A</p>	 <p><b>1637</b> kit rep. transmisión dcha. l/cambio d/'88 r.o.191407283</p>



VOLKSWAGEN PASSAT mod. '88 (1988-1996)



**90073**

buje rueda delantera hasta '94 sin ABS  
r.o.357407615



**90074**

buje rueda delantera hasta '94 con ABS  
r.o.357407615A



**90035**

buje rueda delantera desde '93 salvo 2.0 y 2.8,r.o.357407613B



**90048**

buje rueda delantera 2.0 con ABS y 2.8  
r.o.1H0407613B



**90541**

mangueta rueda trasera **izquierda**, freno de disco,r.o.333501117



**90542**

mangueta rueda trasera **derecha**, freno de disco,r.o.333501118



**90516**

mangueta rueda trasera, tambor sin ABS  
r.o.357501117



**90539**

mangueta rueda trasera **izquierda**, tambor con ABS,r.o.333501117A



**90540**

mangueta rueda trasera **derecha**, tambor con ABS,r.o.333501118A



**96192**

latiguillo freno delantero (365 mm)  
r.o.535611701



**96108**

latiguillo freno trasero (208 mm)  
(racores hembra-hembra),r.o.433611775A



**96175**

latiguillo freno trasero (190 mm)  
(racores hembra-macho),r.o.481611775



**1511**

fuelle cremallera manual  
r.o.191419831

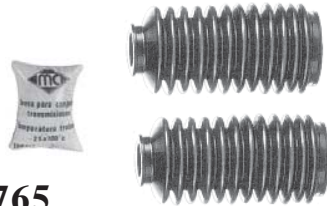

**1765**

jgo reparación cremallera asistida completo  
r.o.175422831



**2301**

casquillo cremallera manual  
r.o.



**1765**

fuelle cremallera asistida  
r.o.175422831



**1765-C**

jgo reparación cremallera asistida completo  
r.o.



**2698**

soporte carburador 1.6  
r.o.037129761



**2695**

soporte carburador 1.6-1.8  
r.o.050129761H



**2876**

guía varilla nivel de aceite Diesel  
r.o.028103663B

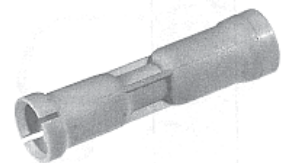

**2448**

guía varilla nivel de aceite (gasolina)  
r.o.053103663



## VOLKSWAGEN PASSAT mod. '88 (1988-1996)

<p><b>¡Nuevo!</b></p>  <p><b>3681</b> cubierto correa distribución 1.6-1.8 r.o.026109173A</p>	<p><b>¡Nuevo!</b></p>  <p><b>3687</b> cubierto correa distribución 1.6 hasta '94 r.o.26109175A</p>	<p><b>¡Nuevo!</b></p>  <p><b>3715</b> cubierto correa distribución 1.8 r.o.026109107B</p>
<p><b>¡Nuevo!</b></p>  <p><b>4760</b> varilla nivel aceite 1.6-1.8-2.0 r.o.027115611C</p>	<p><b>¡Nuevo!</b></p>  <p><b>4749</b> casquillo guía embrague con retén r.o.02A141180A</p>	<p><b>¡Nuevo!</b></p>  <p><b>3691</b> articulación cambio r.o.1J0711256</p>
<p><b>¡Nuevo!</b></p>  <p><b>3672</b> válvula filtro gasoil r.o.191127247</p>	<p><b>016</b> tapón cierre inyectores Diesel r.o.068130229A</p> 	<p><b>4365</b> jgo. tornillo sujeción tapa cubremotor TDi r.o.028103665+028103937+028103638G</p> 
<p><b>¡Nuevo!</b></p>  <p><b>4768</b> rodillo tensor correa alternador r.o.028145278E</p>	<p><b>¡Nuevo!</b></p>  <p><b>4909</b> tensor correa alternador 2.0 gasolina r.o.037903315C</p>	<p><b>Ø 78 mm</b></p>
 <p><b>497</b> soporte escape r.o.803253147</p>	 <p><b>098</b> soporte escape r.o.191253147A</p>	 <p><b>2425</b> soporte tubo de escape desde '95 r.o.</p>
 <p><b>081</b> soporte tubo de escape hasta '94 r.o.357253144</p>	 <p><b>2779</b> kit sujeción escape a colector 1.6 r.o.161298115</p>	 <p><b>2780</b> junta de colector de escape a culata r.o.028129589B</p>
 <p><b>2609</b> tuerca autoblocante buje delantero r.o.191407643</p>	 <p><b>792</b> tuerca rueda r.o.3A0601139</p>	 <p><b>4290</b> polea cigüeñal TurboD sin servodirecc. r.o.028103243T-028103243K</p>

VOLKSWAGEN PASSAT mod. '88 (1988-1996)



**3621**

tapón llenado aceite motor (en plástico, reemplaza al metálico), r.o. 06A103485F

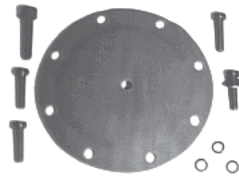

**832**

juego reparación membrana depresor Diesel r.o. 068198821A



**674**

tapón cárter de aceite r.o. 113115193



**864**

cuprepedal freno y embrague r.o. 321721173

**¡Nuevo!**



**3708**

tapón llenado combustible (sin llave) r.o. 1J0201553C

**¡Nuevo!**



**3739**

interruptor luz de freno r.o. 191945515-191945515A/B

SUSPENSION DELANTERA y SOPORTES DE MOTOR

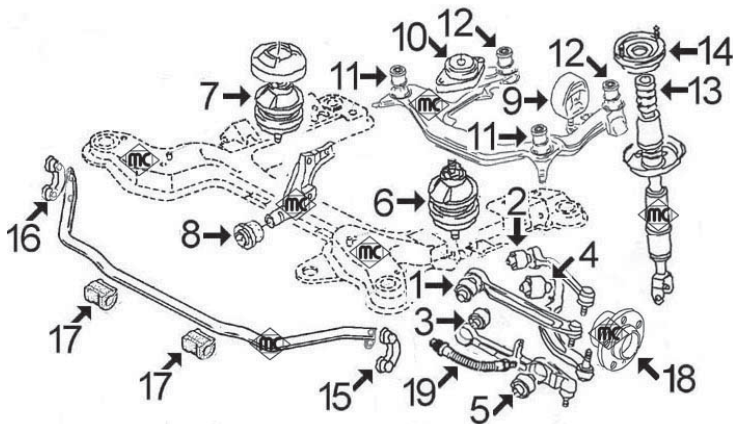

- 1- 4137 silentbloc interior brazo superior (anterior) suspensión delantera
- 2- 4137 silentbloc interior brazo superior (posterior) suspensión delantera
- 3- 4139 silentbloc interior brazo inferior (anterior) suspensión delantera
- 4- 4140 silentbloc interior brazo inferior (posterior) suspensión delantera
- 5- 4138 silentbloc exterior brazo inferior (anterior) suspensión delantera
- 6- 4130 soporte motor izquierdo motores de 4 cilindros  
4131 soporte motor izquierdo motores de 6 cilindros
- 7- 4132 soporte motor derecho motores de 4 cilindros  
4131 soporte motor derecho motores de 6 cilindros
- 8- 4359 silentbloc guía soporte motor delantero
- 9- 4135 soporte izquierdo cambio manual  
4136 soporte izquierdo cambio automático
- 10- 4136 soporte derecho cambio manual y automático
- 11- 4303 silentbloc anterior soporte sub-chasis cambio
- 12- 4304 silentbloc posterior soporte sub-chasis cambio
- 13- 4302 tope poliuretano amortiguador delantero
- 14- 4337 soporte amortiguador delantero
- 15- 4143 bieleta izquierda puntal barra estabilizadora
- 16- 4146 bieleta derecha puntal barra estabilizadora
- 17- 4144 goma para barra estabilizadora de Ø 24 mm  
4145 goma para barra estabilizadora de Ø 27 mm
- 18- 90053 buje rueda delantera todos modelos salvo 1.9TDi con motor AFN y 2.8  
90054 buje rueda delantera 1.9TDi con motor AFN y 2.8
- 19- 96008 latiguillo freno delantero (310 mm)

 <p><b>4130</b> hidráulico soporte motor izquierdo motores de 4 cilindros, r.o. 8D0199379J-8D0199379A/G/S</p>	 <p><b>4131</b> hidráulico soporte motor dcho. e izqdo. motores de 6 cilindros, r.o. 8D0199379K</p>	 <p><b>4132</b> hidráulico soporte motor derecho motores de 4 cilindros, r.o. 8D0199382L/R</p>
 <p><b>4135</b> soporte izquierdo cambio, (cambio manual) r.o. 8D0399151H</p>	 <p><b>4136</b> soporte derecho cambio, manual y automático, r.o. 8D0399151J/M</p>	 <p><b>4137</b> silentbloc brazos superiores suspensión lantera, r.o. 4D0407515C</p>
 <p><b>4138</b> silentbloc brazo inferior (anterior) suspensión delantera, r.o. 4D0407181H</p>	 <p><b>4139</b> silentbloc brazo inferior (anterior) suspensión delantera, r.o. 4D0407182E</p>	 <p><b>4140</b> silentbloc brazo inferior (posterior) suspensión delantera, r.o. 4D0407183M/Q</p>

VOLKSWAGEN PASSAT mod. '97 (1997 - )



**4143**  
bieleta **izquierda** puntal barra estabilizado-  
r.o.N8D0411317D



**4144**  
goma para barra estabilizadora de Ø 24 mm  
(berlina), r.o. 4D0411327G



**4145**  
goma para barra estabilizadora de Ø 27 mm  
(Variant), r.o. 4D0411327H



**4146**  
bieleta **derecha** puntal barra estabilizadora  
r.o. 8D0411318D



**4302**  
tope poliuretano amortiguador delantero  
r.o. 8D0412131F



**4303**  
silentbloc anterior soporte sub-chasis  
cambio, r.o. 8D0399415D



**4304**  
silentbloc posterior soporte sub-chasis  
cambio, r.o. 8D0399419G



**4337**  
soporte amortiguador delantero  
r.o. 4D0412377F



**4359**  
silentbloc guía soporte motor delantero  
r.o. 8D0199339F

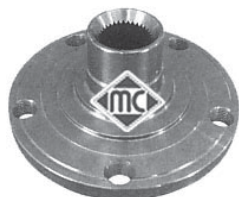

**90053** **33 estrías**  
bujes rueda delantera todos modelos salvo  
1.9TDi (motor AFN) y 2.8, r.o. 8D0407615E

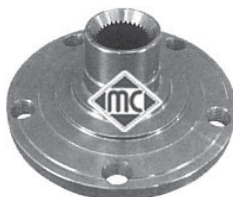

**90054** **38 estrías**  
bujes rueda delantera 1.9TDi (AFN) y 2.8  
r.o. 4A0407615D



**96008**  
latiguillo freno delantero (310 mm)  
r.o. 8D0611707



**96011**  
latiguillo freno trasero (205 mm), hasta '00  
r.o. 8D0611775E

**¡Nuevo!**



**96198**  
latiguillo freno trasero (225 mm) desde '00  
r.o. 8E0611775J









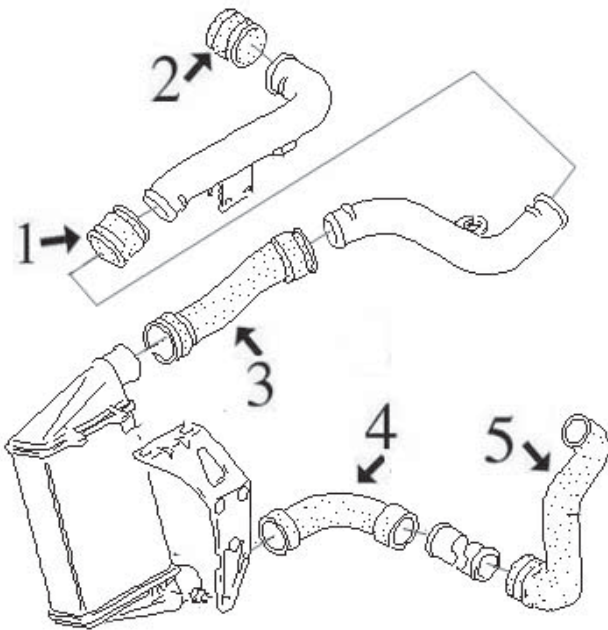



CANALIZACIONES de AIRE de ALTA PRESION INTERCOOLER-TURBO:











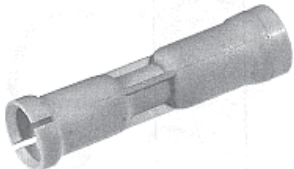









PASSAT-3 1.9 Diesel TDi motor de 100 CV:



- 1- 9061 tubo flexible de empalme hasta 5/'99
- 9071 tubo flexible de empalme desde 5/'99
- 2- 9061 tubo flexible de empalme hasta 5/'99
- 9071 tubo flexible de empalme desde 5/'99
- 3- 9076 tubo flexible de empalme 90-100 CV
- 9077 tubo flexible de empalme 115 CV
- 4- 9075 tubo flexible de intercooler a tubo rígido (fijación con abrazaderas)
- 9074 tubo flexible de intercooler a tubo rígido (fijación con empalme rápido)
- 5- 9073 tubo flexible de tubo rígido a colector de aspiración (fijación con abrazaderas)
- 9072 tubo flexible de tubo rígido a colector de aspiración (fijación con empalme rápido)

<p><b>¡Nuevo!</b></p>  <p><b>9061</b> tubo flexible de empalme hasta 5/'99 r.o. 1H0145834E</p>	<p><b>¡Nuevo!</b></p>  <p><b>9071</b> tubo flexible de empalme desde 5/'99 r.o. 8D0145834A</p>	<p><b>¡Nuevo!</b></p>  <p><b>9072</b> tubo flexible de tubo rígido a colector r.o. 8D0145828L</p>
<p><b>¡Nuevo!</b></p>  <p><b>9073</b> tubo flexible de tubo rígido a colector r.o. 8D0145828G</p>	<p><b>¡Nuevo!</b></p>  <p><b>9074</b> tubo flexible de intercooler a tubo rígido r.o. 3B0145834L</p>	<p><b>¡Nuevo!</b></p>  <p><b>9075</b> tubo flexible de intercooler a tubo rígido r.o. 8D0145834F</p>
<p><b>¡Nuevo!</b></p>  <p><b>9076</b> tubo flexible de empalme 90-100 CV r.o. 058145856A</p>	<p><b>¡Nuevo!</b></p>  <p><b>9077</b> tubo flexible de empalme 115 CV r.o. 058145856K</p>	

## VOLKSWAGEN PASSAT mod. '97 (1997 - )

 <p><b>2448</b> guía varilla nivel aceite 1.8 y 1.9 D d/ '99 r.o.053103663</p>	 <p><b>2876</b> guía varilla nivel aceite 1.6-1.9D hasta '99 r.o.028103663B</p>	 <p><b>3568</b> guía varilla nivel aceite 1.6 desde '99 r.o.06A103663B</p>
<p><i>¡Nuevo!</i></p>  <p><b>3725</b> guía varilla nivel aceite 1.6 r.o.06A103663A</p>	 <p><b>3571</b> guía varilla nivel aceite 1.6-1.8-2.0 r.o.038103663</p>	<p><i>¡Nuevo!</i></p>  <p><b>4759</b> varilla nivel de aceite 1.9D r.o.038115611B</p>
<p><i>¡Nuevo!</i></p>  <p><b>4497</b> polea cigueñal 1.9TDi r.o.038105243F</p>	<p><i>¡Nuevo!</i></p>  <p><b>4498</b> polea cigueñal 1.9TDi r.o.028105243Q</p>	<p><i>¡Nuevo!</i></p>  <p><b>4496</b> polea cigueñal 2.0TDi r.o.03G105243B</p>
<p><i>¡Nuevo!</i></p>  <p><b>4945</b> tensor correa alternador 1.9TDi r.o.028903315N</p>	<p><i>¡Nuevo!</i></p>  <p><b>5044</b> tensor correa alternador 1.9TDi r.o.038903315D/P</p>	
<p><i>¡Nuevo!</i></p>  <p><b>4769</b> rodillo tensor correa alternador 1.9TDi r.o.038145278</p>	<p><i>¡Nuevo!</i></p>  <p><b>4997</b>      Ø 61/55 mm, H=41 mm polea de alternador de rueda libre r.o.022903119A</p>	<p><i>¡Nuevo!</i></p>  <p><b>5002</b>      Ø 61/56 mm, H=35 mm polea de alternador de rueda libre r.o.022903119B</p>
<p><i>¡Nuevo!</i></p>  <p><b>5003</b>      Ø 61/56 mm, H=35 mm polea de alternador de rueda libre r.o.028903119T</p>	<p><i>¡Nuevo!</i></p>  <p><b>3672</b> válvula filtro gasoil hasta '99 r.o.191127247A</p>	<p><i>¡Nuevo!</i></p>  <p><b>3689</b> válvula filtro gasoil desde '99 r.o.1J0127247A</p>
<p><i>¡Nuevo!</i></p>  <p><b>3708</b> tapón llenado combustible (sin llave) r.o.1J0201553C</p>	<p><i>¡Nuevo!</i></p>  <p><b>3719</b> válvula desvaporizadora 1.9TDi r.o.028129101D</p>	 <p><b>3528</b> tapa de termostato 1.6 - 1.8 (salvo motor 1.6AHL), r.o.030121121B</p>

VOLKSWAGEN PASSAT mod. '97 (1997 - )



**3601**  
tapa de termostato 1.6 (AHL)  
r.o.06B121121



**3593**  
tapa de termostato 1.9D-TDi  
r.o.048121121B



**3587**  
boquilla en culata (lateral) 1.9D-TDi  
r.o.028121144N



**3542**  
boquilla en culata (frontal) 1.9 D-TDi  
r.o.028121132



**3566**  
boquilla en culata (lateral) 1.8  
r.o.058121132-058121133B



**3596**  
boquilla en culata (lateral) 1.6  
r.o.050121133C-050121132A



**3540**  
kit tapón sensores eléctricos en tapas agua  
r.o.357121140+032121142



**3623**  
botella de expansión  
r.o.8D0121403L



**3573**  
tapón botella de expansión  
r.o.1J0121321B



**1187**  
kit fuelle transmisión lado rueda  
(Ø24-92 mm), r.o.441498203A



**1297**  
kit fuelle transmisión lado rueda  
(Ø26-86 mm), r.o.8D0498203A



**1560**  
kit fuelle transmisión l/cambio Ø 100 mm  
r.o.



**2308**  
kit fuelle transmisión l/cambio Ø 107 mm  
r.o.



**1300**  
fuelle izquierdo cremallera dirección  
r.o.4D0419831D



**1369**  
fuelle derecho cremallera dirección  
r.o.8D0419831J

**¡Nuevo!**



**3737**  
interruptor luz de freno 2 polos (gasolina)  
r.o.443945515

**¡Nuevo!**



**3735**  
interruptor luz de freno 4 polos (Diesel)  
r.o.4A0945515A



**2780**  
junta colector escape 1.9 D-TDi  
r.o.028129589B



**4123**  
soporte delantero escape  
r.o.1J0253144E



**2735**  
soporte trasero escape  
r.o.8D0253144R

VOLKSWAGEN PASSAT mod. '97 (1997 - )



**2736**  
soporte trasero escape  
r.o. 8D0253144S



**4097**  
soporte trasero escape  
r.o. 8D0253144M



**2737**  
tope silenciador  
r.o. 4A0253149C



**2916**  
tapón cárter de aceite desde '97 (salvo V6)  
r.o. N90813201



**4248**  
tornillo rueda  
r.o. 8D0601139D



**4365**  
jgo. tornillo sujeción tapa cubremotor  
r.o. 028103665+028103937+028103638G



**3621**  
tapón llenado aceite motor  
r.o. 026103485



# VOLKSWAGEN POLO-1 (1984-1994)

## CANALIZACIONES DE AGUA

### POLO 1.300 motor HK (hasta '7/85):

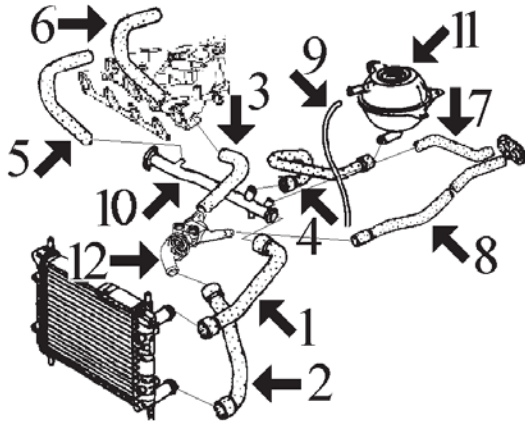

- 1- n/d mgto superior radiador
- 2- n/d mgto inferior radiador
- 3- n/d mgto de termostato a colector (2 tramos, con rosca para sensor intercalada)
- 4- 7914 mgto de tubo metálico a botella de expansión
- 5- n/d mgto de tubo metálico a colector de admisión
- 6- n/d mgto de carburador a colector de admisión
- 7- 7936 mgto derecho de calefactor a tubo metálico
- 8- 7935 mgto izquierdo de calefactor a racor
- 9- 116 mgto sobrante de botella a radiador: Cortar de rollo MC-116 Ø8x14 mm, long. aprox. 450 mm
- 10- 3087 tubo de agua metálico
- 11- 3574 tapón botella de expansión
- 12- 3528 tapa de termostato (plástico)
- 3543 cuerpo plástico unión manguitos

### POLO 1.300 motores MH (de '8/85 a '12/88) y 2G (desde '89 hasta '95) y POLO 1.050 motor HK (desde '86 hasta '95)

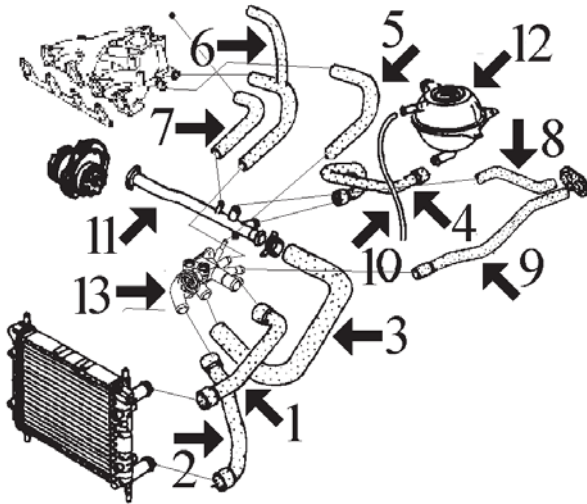

- 1- 7633 mgto superior radiador motor
- 2- 7632 mgto inferior radiador motor
- 3- 7929 mgto de racor a tubo metálico
- 4- 7914 mgto de tubo metálico a botella expansión
- 5- 7930 mgto de tubo metálico a colector de admisión \*
- 6- 7932 mgto de tubo metálico a colector y carburador, 1.3 motores MH y 2G \*
- 7931 mgto de tubo metálico a colector y carburador, 1.05 hasta '91
- 7968 mgto de tubo metálico a colector 1.05 desde '91
- 7- 7934 mgto de tubo metálico a carburador 1300 \*
- n/d mgto de tubo metálico a carburador 1050
- 8- 7936 mgto derecho de calefactor a tubo metálico
- 9- 7935 mgto izquierdo de calefactor a a racor
- 10- 116 mgto de botella a radiador: Cortar de rollo MC-116 Ø8x14 mm, long. aprox 450 mm
- 11- 3087 tubo de agua metálico hasta '94
- 3618 tubo de agua desde '94 (plástico)
- 12- 3574 tapón botella de expansión
- 13- 3528 tapa de termostato hasta '98
- 3543 cuerpo plástico unión manguitos
- 3541 tapa de termostato desde '98
- 8085 mgto desvaporizador 1.3 (3 vias)
- 8319 mgto desvaporizador 1.05

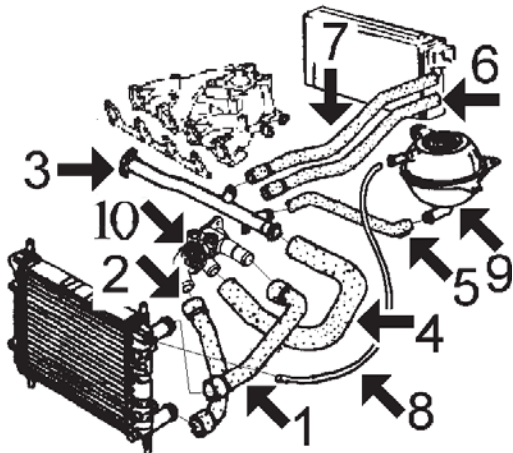

\* excepto versiones de inyección

### POLO 1.4 DIESEL motores MN y 1W (desde '86 hasta '95)



- 1- 7633 mgto superior radiador
- 2- 7632 mgto inferior radiador hasta '91
- 3- 3087 tubo de agua metálico
- 4- 7929 mgto de racor a tubo metálico
- 5- 7914 mgto de tubo metálico a botella
- 6- 7935 mgto de calefactor a culata
- 7- 7936 mgto de calefactor a tubo metálico
- 8- 116 mgto de botella a radiador: Cortar de rollo MC-116 Ø8x14 mm, long. aprox 450 mm
- 9- 3574 tapón botella de expansión
- 10- 3528 tapa de termostato (plástico)
- 3543 cuerpo plástico unión manguitos
- 8085 mgto desvaporizador (3 vias)







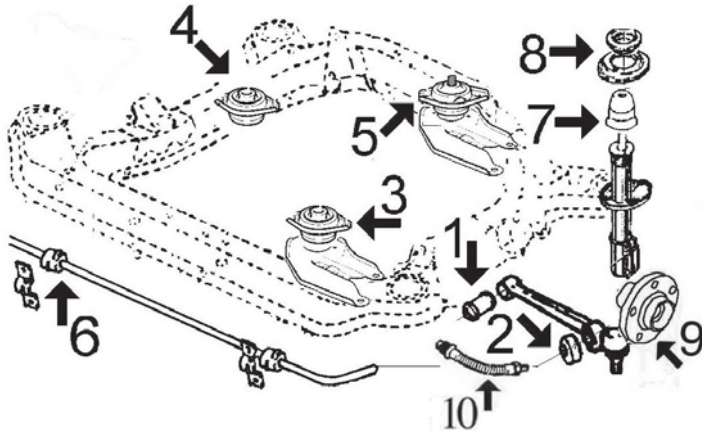



## VOLKSWAGEN POLO-1 (1984-1994)

 <p><b>7632</b> mgto inferior radiador 1.3 - 1.05 y 1.4D r.o.030121061</p>	 <p><b>7633</b> mgto superior radiador 1.3 MH-2G, 1.05 y Diesel, r.o.030121055B</p>	 <p><b>7914</b> mgto de botella a tubo metálico todos r.o.867121109</p>
 <p><b>7929</b> mgto de racor entrada a tubo metálico 1.3 motores MH-2G y 1.05, r.o.030121063</p>	 <p><b>7930</b> mgto termostato a colector 1.3 MH-2G y 1.05, r.o.030121056D</p>	 <p><b>7931</b> mgto de tubo a colector 1050 cc r.o.030121054F</p>
 <p><b>7932</b> mgto de tubo a colector 1.3 MH y 2G r.o.030121054</p>	 <p><b>7934</b> mgto de carburador a tubo metálico 1.300 MH-2G, r.o.052121054P</p>	 <p><b>7935</b> mgto izquierdo calefactor todos mods. r.o.867819371B</p>
 <p><b>7936</b> mgto derecho calefactor todos mods. r.o.867819373</p>	 <p><b>7968</b> mgto de tubo metálico a colector 1.05 d/'91 r.o.030121054L</p>	 <p><b>8085</b> mgto desvaporizador 1.3 MH-2G - 1.05 y Diesel, r.o.030103493M</p>
 <p><b>8319</b> mgto desvaporizador 1.05 desde '91 r.o.030103493N</p>	 <p><b>3087</b> tubo de agua metálico hasta '94 r.o.052121071Q-030121065A</p>	 <p><b>3543</b> brida agua conexión mgto r.o.r.o.030121117L-030121117M</p>
 <p><b>3618</b> tubo de agua desde '94 (salvo Diesel) r.o.030121065J</p>	 <p><b>3528</b> tapa de termostato r.o.030121121B</p>	 <p><b>3574</b> tapón botella de expansión r.o.443121321</p>

SUSPENSION DELANTERA y SOPORTES DE MOTOR:



- 1- 2843 silentbloc brazo delantero de suspensión
- 2- 2842 silentbloc extremo barra estabilizadora
- 3- 802 soporte de motor delantero izqdo. gasolina  
2630 soporte motor delantero izqdo. Diesel
- 4- 802 soporte de motor derecho gasolina  
2630 soporte de motor derecho Diesel
- 5- 802 soporte de motor trasero gasolina  
846 soporte de motor trasero Diesel
- 6- 652 goma soporte barra estabilizadora
- 7- 2844 tope poliuretano suspensión delantera
- 8- 922 soporte de amortiguador con rodamiento Ø 12
- 9- 90018 buje de rueda delantera
- 10- 96106 latiguillo freno delantero (290 mm)

 <p><b>2843</b> silentbloc brazo delantero hasta '95 r.o. 861407181-823407181</p>	 <p><b>2842</b> silentbloc extremo barra estab. hasta '95 r.o. 861407183</p>	 <p><b>2844</b> tope poliuretano amortiguador delantero hasta '95, r.o. 861412131</p>
 <p><b>652</b> goma soporte barra estabilizadora hasta '95 r.o. 867411313</p>	 <p><b>922</b>      <b>rodamiento de Ø 12 mm</b> soporte amortiguador delantero hasta '95 r.o. 871412323A</p>	 <p><b>802</b> soporte de motor (salvo Diesel) hasta '95 r.o. 867199383A</p>
 <p><b>2630</b> soporte de motor Diesel hasta '95 r.o. 867199323A</p>	 <p><b>846</b> soporte de motor trasero Diesel hasta '95 r.o. 191199402</p>	 <p><b>1507</b> fuelle cremallera dirección hasta '95 r.o. 861419831B</p>
 <p><b>90018</b> bujes rueda delantera r.o. 861407615A</p>	 <p><b>90516</b> mangueta rueda trasera r.o. 357501117</p>	

## VOLKSWAGEN POLO-1 (1984-1994)



**96106**  
latiguillo freno delantero (290 mm)  
r.o. 861611707B



**96108**  
latiguillo freno trasero (205 mm)  
r.o. 433611775A

**¡Nuevo!**



**3739**  
interruptor luz de freno (2 polos)  
r.o. 191945511-191945511A/B



**1359**  
kit rep. transmisión izquierda l/rueda  
r.o. 191498203C (bocas Ø21-78 mm)

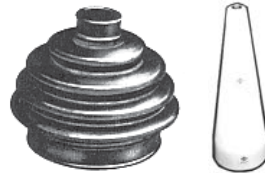

**1359E** para montar con cono  
kit rep. transmisión izquierda l/rueda  
r.o. 191498203C (bocas Ø21-78 mm)



**1689E**  
kit rep. transmisión derecha l/rueda  
r.o. 871498203C (bocas Ø18-78 mm)



**1632**  
kit fuelle transmisión l/cambio  
r.o. 171407282B (bocas Ø21-89 mm)

**¡Nuevo!**



**3724**  
juego reparación rótula palanca de cambio  
r.o. 191711595A

**¡Nuevo!**



**4902**  
articulación cambio 5 marchas  
r.o. 191711233



**2699**  
soporte carburador 1.3 motor AAV y 1.4  
r.o. 030129765G



**2815**  
soporte carburador 1.3 motores 2G-MH y  
1.05 motor HK, r.o. 052129765E

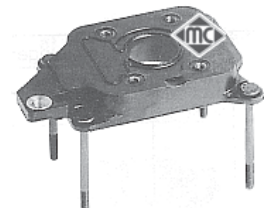

**2846**  
soporte carburador 1.05 motor AAU  
r.o. 030129765D

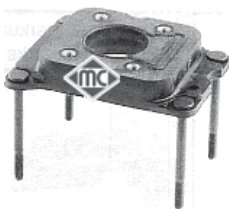

**2855**  
soporte carburador 1.6  
r.o. 032129765



**864**  
cubrepedal freno y embrague desde '85  
r.o. 321721173



**238**  
soporte tubo de escape  
r.o. 823523149



**366**  
soporte tubo de escape  
r.o. 861253147 (32x59)



**3621**  
tapón llenado aceite motor (en plástico, reemplaza al metálico), r.o.

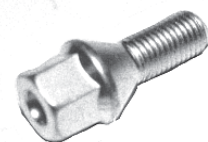

**792**  
tuerca rueda  
r.o. 3A0601139



**2609**  
tuerca homocinética M-20x150  
r.o. 1L0407643



**674**  
tapón cárter de aceite  
r.o. 113115493



# VOLKSWAGEN POLO '95 (1995-2001)

## CANALIZACIONES DE AGUA

**POLO '95** 1.05 desde 10/'94 hasta 06/'96 motor AEV  
 1.3 desde 10/'94 hasta 04/'97 motor ADX  
 1.6 desde 10/'94 hasta 9/'95 motor AEA

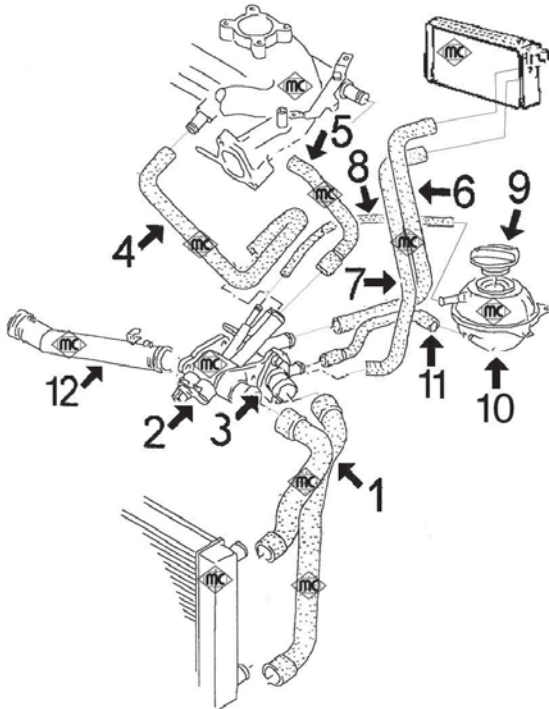

- 1- 8796 mgtto superior e inferior radiador (ensamblados)
- 2- n/d cuerpo de termostato
- 3- 3588 tapa de termostato
- 4- 8802 mgtto de cuerpo termostato a culata 1.05  
8801 mgtto de cuerpo termostato a culata 1.3 - 1.6
- 5- 8800 mgtto de cuerpo termostato a colector 1.05  
8799 mgtto de cuerpo termostato a colector 1.3 - 1.6
- 6- 8803 mgtto entrada agua a calefactor
- 7- 8806 mgtto retorno agua de calefactor
- 8- 116 mgtto sobrante de botella a termostato: cortar de rollo MC-116 Ø8x14 mm, long. aprox. 350 mm
- 9- 3506 tapón botella expansión
- 10- 3610 botella expansión
- 11- 8798 mgtto de cuerpo termostato a botella
- 12- 3625 tubo de agua (plástico) con juntas tóricas

8812 mgtto desvaporizador

**POLO '95** 1.0 desde 07/'96 hasta 10/'99 motor AER  
 1.0 desde 08/'97 motores ALL y ADL  
 1.4 desde 07/'95 hasta 12/'97 motor AEX  
 1.4 desde 04/'96 motores de 16V AFH, APE, AQQ, AUB, AHW y AFK  
 1.4 desde 05/'97 hasta 10/'99 motor AKV  
 1.4 desde 11/'97 hasta 10/'99 motor APQ  
 1.4 desde 01/'98 hasta 10/'99 motor ANX  
 1.6 desde 10/'95 hasta 10/'99 motores AEE  
 1.6 desde 03/'98 hasta 10/'99 motor AHS, AJV  
 1.6 desde 10/'99 motores de 16V ARC, AUY

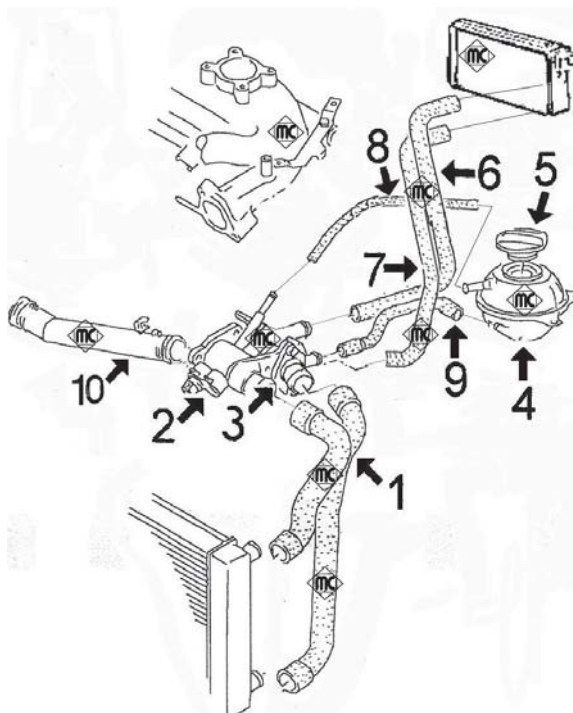

- 1- 8797 mgtto superior e inferior radiador (ensamblados)
- 2- 3615 cuerpo de termostato completo con termostato, tapa y accesorios
- 3- 3592 kit de termostato completo con tapa y junta  
3541 tapa de termostato
- 4- 3610 botella de expansión
- 5- 3506 tapón botella de expansión
- 6- 8803 mgtto entrada agua a calefactor hasta 10/'95  
8807 mgtto entrada agua a calefactor desde 10/'95
- 7- 8806 mgtto retorno agua de calefactor
- 8- 116 mgtto sobrante de botella a termostato: cortar de rollo MC-116 Ø8x14 mm, long. aprox. 350 mm
- 9- 8798 mgtto de cuerpo termostato a botella
- 10- 3625 tubo de agua (plástico) con juntas tóricas





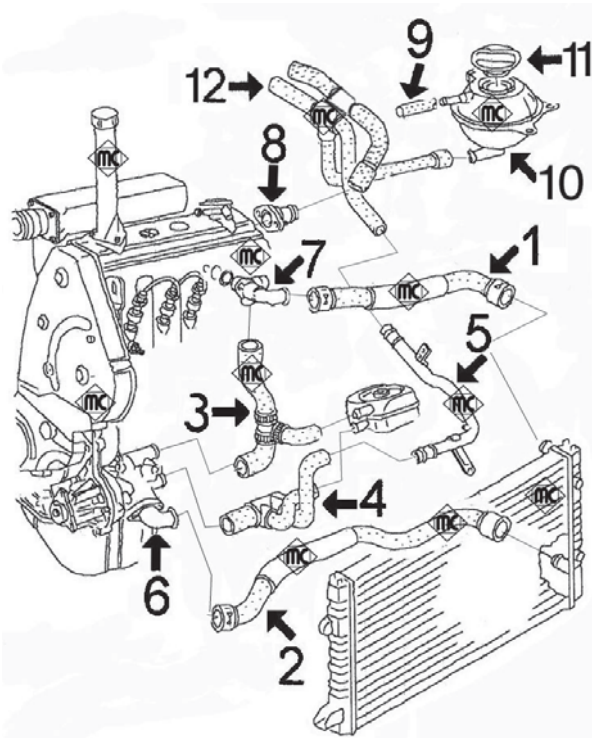















8811 mgtto desvaporizador

POLO '95 1.9 Diesel desde 10/'94 motor AEF  
 1.9 Diesel desde 07/'96 motor AGD "SDi"  
 1.7 Diesel desde 04/'97 motores AHG-AKU-ASX "SDi"



- 1- 8804 mgtto superior radiador
- 2- 8805 mgtto inferior radiador
- 3- 8809 mgtto de bomba agua a racor en culata y a intercambiador 1.9 D (3 vias)
- 8808 mgtto de bomba agua a racor en culata 1.7 D
- 4- 8384 mgtto de bomba agua a intercambiador y a tubo metálico 1.9 Diesel (3 vias)
- 8810 mgtto de bomba agua a tubo metálico 1.7 Diesel
- 5- 3158 tubo de agua metálico 1.9 Diesel
- 3157 tubo de agua metálico 1.7 Diesel
- 6- 3528 tapa de termostato
- 7- 3614 racor en culata 1.9 Diesel AEF
- 3585 racor en culata 1.9 Diesel AGD (SDi) y 1.7 Diesel
- 8- 3517 boquilla lateral en culata 1.9 Diesel AEF
- 9- 116 mgtto sobrante de botella: cortar de rollo MC-116 Ø 8x14 mm, long. aprox. 400 mm
- 10- 3610 botella de expansión
- 11- 3506 tapón botella de expansión
- 12- 8813 mgtto doble de calefactor 1.9 Diesel AEF
- 8814 mgtto doble de calefactor 1.9 Diesel AGN (SDi) y 1.7 Diesel

## VOLKSWAGEN POLO '95 (1995-2001)

 <p><b>8384</b> mgto de bomba de agua a intercambiador 1.9 Diesel, r.o. 037122058A</p>	 <p><b>8796</b> mgto superior/inferior radiador 1.05-1.3-1.6 r.o.</p>	 <p><b>8797</b> mgto superior/inferior radiador 1.0-1.4-1.6 r.o.</p>
 <p><b>8798</b> mgto de cuerpo termostato a botella (salvo Diesel), r.o.</p>	 <p><b>8799</b> mgto de cuerpo termostato a colector 1.3-1.6 r.o.</p>	 <p><b>8800</b> mgto de cuerpo termostato a colector 1.05 r.o.</p>
 <p><b>8801</b> mgto de cuerpo termostato a culata 1.3-1.6 r.o.</p>	 <p><b>8802</b> mgto de cuerpo termostato a culata 1.05 r.o.</p>	 <p><b>8803</b> mgto entrada calefactor 1.0-1.4-1.6 hasta 10/95, r.o.</p>
 <p><b>8804</b> mgto superior radiador 1.9 D-1.7 D r.o.</p>	 <p><b>8805</b> mgto inferior radiador 1.9 D-1.7 D r.o.</p>	 <p><b>8806</b> mgto retorno calefactor 1.0-1.4-1.6 r.o.</p>
 <p><b>8807</b> mgto entrada calefactor 1.0-1.4-1.6 desde 10/95, r.o.</p>	 <p><b>8808</b> mgto de bomba agua a racor en culata 1.7 D r.o.</p>	 <p><b>8809</b> mgto de bomba agua a racor culata 1.9 D r.o.</p>
 <p><b>8810</b> mgto de bomba agua a tubo metálico 1.7 D r.o.</p>	 <p><b>8811</b> mgto desvaporizador 1.0-1.4-1.6 r.o.</p>	 <p><b>8812</b> mgto desvaporizador 1.3-1.6 hasta 10/95 r.o.</p>
 <p><b>8813</b> mgto doble de calefactor 1.9 Diesel r.o.</p>	 <p><b>8814</b> mgto doble de calefactor 1.7 Diesel r.o.</p>	

VOLKSWAGEN POLO '95 (1995-2001)



**3157**  
tubo de agua metálico 1.7 Diesel  
r.o.6N0121065G



**3158**  
tubo de agua metálico 1.9 Diesel  
r.o.6N0121065H-6N0121065A



**3517**  
boquilla en culata 1.7D-1.9 Diesel  
r.o.026121145E



**3528**  
tapa de termostato 1.7-1.9 Diesel  
r.o.030121121B



**3540**  
jgo tapón, junta y pasador para cubrir to-  
mas para sensor eléctrico en tapas agua.



**3541**  
tapa de termostato 1.0-1.4-1.6 desde 10/96  
r.o.032121121B/J



**3506**  
tapón botella de expansión  
r.o.1H0121321A



**3585**  
racor en culata (frontal) 1.9SDi y 1.7 Diesel  
r.o.028121132C



**3588**  
tapa de termostato 1.05-1.3-1.6 hasta 10/95  
r.o.032121121A



**3592**  
kit completo de termostato, tapa y junta 1.0-  
1.4-1.6,r.o.032121121J+032121110B



**3610**  
botella de expansión  
r.o.6N0121407A



**3614**  
racor en culata (frontal) 1.9 Diesel  
r.o.028121132B

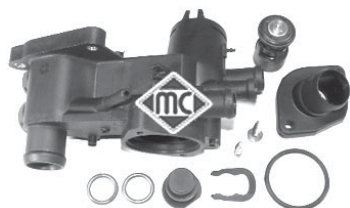

**3615**  
cuerpo de termostato 1.0-1.4-1.6 completo  
**con termostato**,r.o.032121111N



**3625**  
tubo de agua (plástico) con juntas tóricas  
1.4-1.6,r.o.032121065D



**3591**  
racor en culata 1.4TDi ('00-)  
r.o.038121132C



# VOLKSWAGEN POLO '95 (1995-2001)

## SUSPENSION DELANTERA y SOPORTES DE MOTOR:

1.05 - 1.3 - 1.4 - 1.4/16v - 1.6 - 1.6/16v  
1.7SDi - 1.9D - 1.9SDi

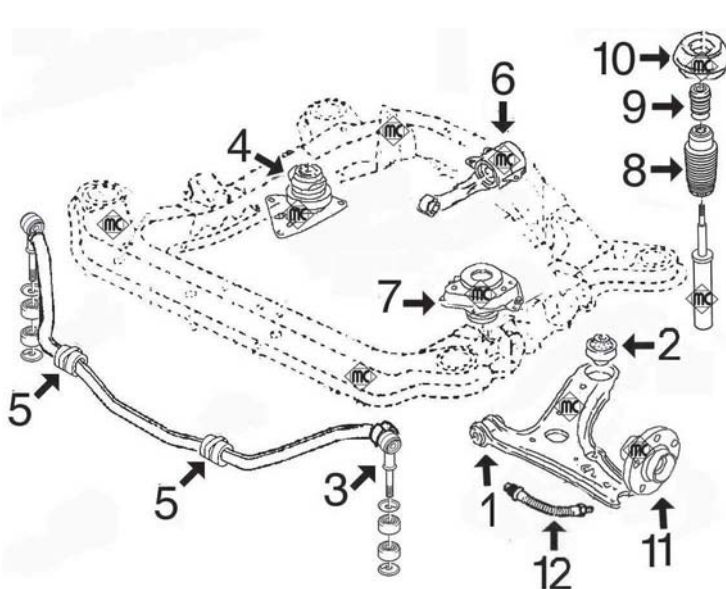

- 1- 2859 silentbloc anterior trapecio delantero
- 2- 2858 silentbloc posterior trapecio delantero
- 3- 2853 bieleta puntal barra estabilizadora completa
- 4- 4095 soporte motor derecho 1.0-1.05-1.3-1.4 y 1.6
- 4317 soporte motor derecho 1.7 D y 1.9 Diesel
- 5- 4318 goma para barra estabilizadora de Ø 18 mm
- 4319 goma para barra estabilizadora de Ø 20 mm
- 6- 4169 soporte motor trasero
- 7- 4096 soporte motor izqdo 1.0-1.3-1.4 (salvo 16v) y 1.6
- 4415 soporte motor izqdo. 1.4-16v, 1.7D y 1.9 Diesel
- 8- 4324 capuchón amortiguador delantero hasta 10/'99
- 4765 juego fuelle amortiguador delantero desde 10/'99 completo con tope de poliuretano
- 9- 4298 tope poliuretano amortiguador delt. hasta 10/'99
- 4765 juego tope poliuretano con fuelle desde 10/'99
- 10- 2877 soporte superior amortiguador delantero completo con rodamiento hasta 10/'99
- 4788 soporte superior amortiguador delantero completo con rodamiento desde 10/'99
- 11- 90034 buje de rueda delantera
- 12- 96128 latiguillo freno delantero (380 mm)

1.4 TDi (desde 10/'99-)

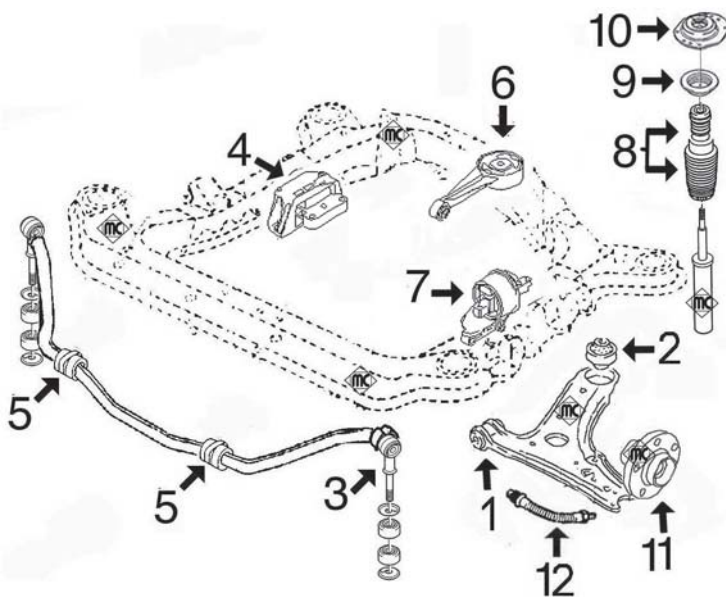

- 1- 2859 silentbloc anterior trapecio delantero
- 2- 2858 silentbloc posterior trapecio delantero
- 3- 2853 bieleta puntal barra estabilizadora completa
- 4- 4790 soporte motor derecho
- 5- 4318 goma para barra estabilizadora de Ø 18 mm
- 4319 goma para barra estabilizadora de Ø 20 mm
- 6- 4784 soporte motor trasero
- 7- 4783 soporte motor izquierdo
- 8- 4765 juego capuchón amortiguador delantero y tope de poliuretano
- 9- 4789 rodamiento soporte amortiguador
- 10- 4788 soporte superior amortiguador delantero completo con rodamiento
- 11- 90034 buje de rueda delantera
- 12- 96128 latiguillo freno delantero (380 mm)

SUSPENSION TRASERA:

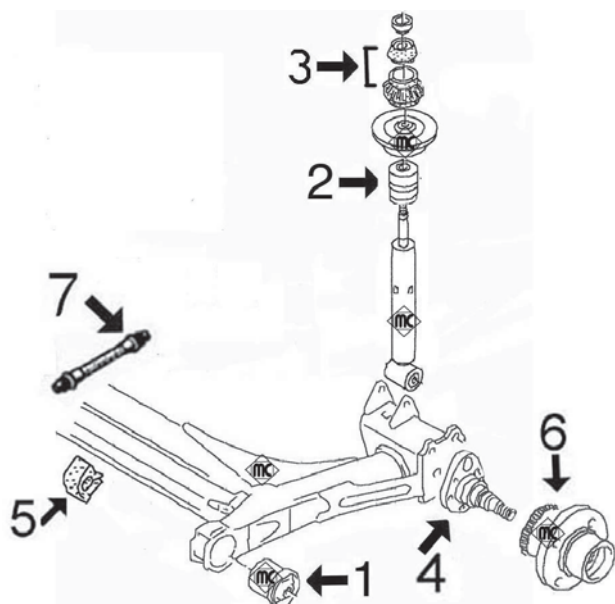

- 1- 2839 silentbloc puente trasero hasta 10/'99  
4907 silentbloc puente trasero desde 10/'99
- 2- 4299 tope poliuretano amortiguador trasero
- 3- 4320 jgo. soportes amortiguador trasero
- 4- 90516 mangueta rueda trasera (dcha. e izqda.), freno de tambor sin ABS hasta 6/'99  
90539 mangueta rueda trasera izquierda, tambor con ABS hasta 6/'99  
90540 mangueta rueda trasera derecha, tambor con ABS hasta 6/'99  
90541 mangueta rueda trasera izquierda, freno de disco hasta 6/'99  
90542 mangueta rueda trasera derecha, freno de disco hasta 6/'99
- 5- 2824 goma barra estabilizadora
- 6- 90525 buje de rueda desde 6/'99 con rodamiento
- 7- 96199 latiguillo freno trasero (143 mm)  
96175 latiguillo freno trasero (190 mm)



**2839**  
silentbloc puente trasero hasta '00  
r.o. 6N0501541D



**2853**  
bieleta puntal barra estabilizadora **completa**  
r.o. 6N0411315



**2858**  
silentbloc posterior trapecio delantero  
r.o. 6N0407181



**2859**  
silentbloc anterior trapecio delantero  
r.o. no hay despiece, va con el brazo



**2877**  
soporte amortiguador delantero completo  
**con rodamiento** r.o. 6N0412331A+1J0412249



**4095**  
soporte motor derecho motores 1.0-1.3-1.4 y 1.6, r.o. 6N0199262A

## VOLKSWAGEN POLO '95 (1995-2001)



**4096**  
soporte motor izqdo 1.0-1.3-1.4 (salvo 16v) y 1.6, r.o. 6N0199555G/C/AA



**4169**  
soporte motor trasero r.o. 6N0199851AG



**4298**  
tope poliuretano amortiguador delantero hasta 10/99, r.o. 1H0412303B



**4299**  
tope poliuretano amortiguador trasero r.o. 6N0512131A

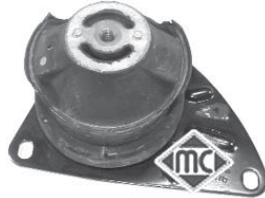

**4317**  
soporte motor derecho 1.7D-1.9 Diesel r.o. 6N0199262K



**4415**  
soporte motor izqd. 1.4-16v, 1.7D y 1.9D r.o. 6N0199555H



**4318**  
goma para barra estabilizadora Ø 18 mm r.o. 6X0411313



**4319**  
goma para barra estabilizadora Ø 19 mm r.o. 6X0411313A

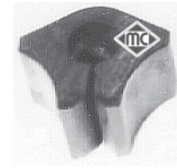

**2824**  
goma barra estabilizadora trasera r.o. 871511423



**4320**  
juego soportes amortiguador trasero r.o. 191512333+191512335



**4324**  
fuelle amortiguador delantero r.o. 357413175A

**¡Nuevo!**

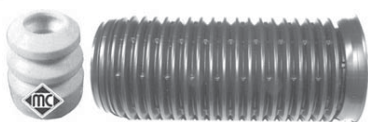

**4765**  
juego capuchón y tope de amortiguador delantero desde 10/99, r.o.

**¡Nuevo!**

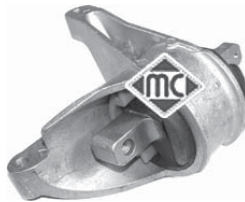

**4783**  
soporte motor izquierdo 1.4TDi r.o. 6N0199543F

**¡Nuevo!**



**4784**  
soporte motor trasero 1.4TDi r.o. 6N0199851AF

**¡Nuevo!**



**4788**  
soporte amortiguador delantero desde 10/99 completo con rodamiento, r.o. 6N0412331E

**¡Nuevo!**



**4789**  
rodamiento soporte amortiguador delantero r.o. 6N0412249C

**¡Nuevo!**

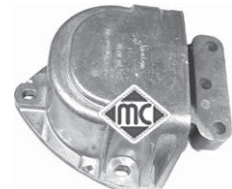

**4790**  
soporte motor derecho 1.4TDi r.o. 6N0199867BF

**¡Nuevo!**



**4907**  
silentbloc brazo suspensión trasera desde 10/99, r.o. 6K0501541A

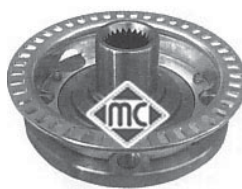

**90034**  
buje rueda delantera r.o. 6N0407613



**2609**  
tuerca junta homocinética r.o.



## VOLKSWAGEN POLO '95 (1995-2001)



**90516**

mangueta rueda trasera, tambor sin ABS hasta 6/'99, r.o. 357501117



**90539**

mangueta rueda trasera **izquierda**, tambor con ABS hasta 6/'99, r.o. 333501117A



**90540**

mangueta rueda trasera **derecha**, tambor con ABS hasta 6/'99, r.o. 333501118A



**90541**

mangueta rueda trasera **izquierda**, freno de disco hasta 6/'99, r.o. 333501117



**90542**

mangueta rueda trasera **derecha**, freno de disco hasta 6/'99, r.o. 333501118



**90525**

buje de rueda trasera **con rodamiento** desde 6/'99, r.o. 6X0598477



**96128**

latiguillo freno delantero (410 mm) r.o. 6N0611701A/B

**¡Nuevo!**



**96199**

latiguillo freno trasero (143 mm) r.o. 6N0611775A



**96175**

latiguillo freno trasero (190 mm) r.o. 893611775A



**1436**

fuelle cremallera manual r.o. 6N0419831



**1357**

fuelle cremallera asistida r.o. 6N0422831

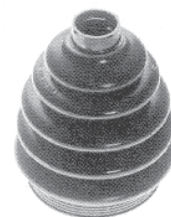

**1921**

kit fuelle transmisión lado rueda **Ø 77 mm** r.o. 6N0498203



**1297**

kit fuelle transmisión lado rueda **Ø 86 mm** r.o.



**1632**

kit fuelle transmisión lado cambio (**Ø 21-89 mm**) r.o. 6N0498201



**1061**

kit fuelle transmisión lado cambio desde '99 (**Ø 27-89 mm**)



**1106**

kit rep. transmisión l/cambio desde '99 (**Ø 27-94 mm**)



**1192**

kit rep. transm izquierda l/cambio 1.4TDi (**Ø 27-100 mm**), r.o.



**1637**

kit rep. transm. dcha. l/cambio 1.4TDi (**Ø 24-100 mm**), r.o.

**¡Nuevo!**



**4495**

polea cigueñal 1.7SDi-1.9D-1.9SDi r.o. 028105243AC

**¡Nuevo!**



**4492**

polea cigueñal 1.4TDi r.o. 045105243B



















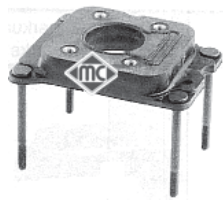
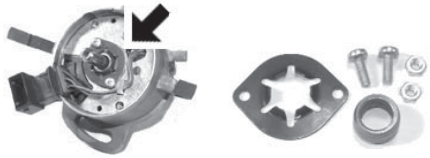

**4365**

jgo. tornillo sujeción tapa cubremotor r.o. 028103665+028103937+028103638G

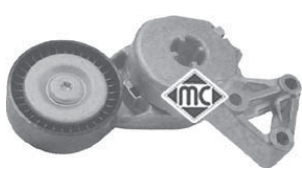

## VOLKSWAGEN POLO '95 (1995-2001)

<p><b>iNuevo!</b></p>  <p><b>4793</b> varilla nivel aceite 1.0-1.05-1.3-1.4-1.6 r.o.</p>	<p><b>iNuevo!</b></p>  <p><b>4791</b> varilla nivel aceite 1.7SDi-1.9D/SDi r.o.</p>	<p><b>iNuevo!</b></p>  <p><b>4794</b> varilla nivel aceite 1.4TDi r.o.</p>
 <p><b>4355</b> guía varilla nivel aceite 1.0-1.4-1.6 r.o.030115636A</p>	<p><b>iNuevo!</b></p>  <p><b>3725</b> guía varilla nivel aceite 1.4TDi r.o.06A103663A</p>	
<p><b>iNuevo!</b></p>  <p><b>3672</b> válvula filtro gasoil hasta 10/'99 r.o.191127247A</p>	<p><b>iNuevo!</b></p>  <p><b>3689</b> válvula filtro gasoil desde 10/'99 r.o.1J0127247</p>	<p><b>iNuevo!</b></p>  <p><b>4766</b> guía cerradura maneta puerta hasta '98 r.o.1H0837223B</p>
<p><b>iNuevo!</b></p>  <p><b>3724</b> rótula y alojamiento base palanca cambio 1.0-1.05-1.3-1.4-1.6,r.o.</p>	 <p><b>4353</b> bioleta mando cambio 1.7 D - 1.9 Diesel r.o.6N0711575A</p>	<p><b>iNuevo!</b></p>  <p><b>4903</b> casquillo guía embrague todos salvo 1.4D r.o.085141181</p>
<p><b>iNuevo!</b></p>  <p><b>4749</b> casquillo guía embrague 1.4TDi r.o.02A141180A</p>	<p><b>iNuevo!</b></p>  <p><b>2855</b> soporte carburador 1.6 hasta 10/'95 (AEA) r.o.032129765</p>	<p><b>iNuevo!</b></p>  <p><b>4296</b> kit reparación distribuidor Magneti-Marelli (casquillo sinterizado del eje rotor)</p>
<p><b>iNuevo!</b></p>  <p><b>4771</b> rodillo tensor correa alternador 1.7D-1.9D r.o.028145278M</p>	<p><b>iNuevo!</b></p>  <p><b>4770</b> tensor correa alternador 1.0-1.05-1.3-1.4- 1.4/16v-1.6-1.6/16v,r.o.030145299F</p>	<p><b>iNuevo!</b></p>  <p><b>4923</b> tensor correa alternador 1.9Diesel r.o.028903315P</p>
<p><b>iNuevo!</b></p>  <p><b>5010</b> tensor correa alternador 1.4TDi r.o.06A903315E</p>	<p><b>iNuevo!</b></p>  <p><b>4997</b>      Ø 61/55 mm, H=41 mm polea alternador de rueda libre r.o.038903119T</p>	<p><b>iNuevo!</b></p>  <p><b>5000</b>      Ø 61/56 mm, H=37 mm polea alternador de rueda libre r.o.038903119Q</p>

## VOLKSWAGEN POLO '95 (1995-2001)



**2426**  
soporte delantero tubo de escape  
r.o. 1H0253147B



**2425**  
soporte trasero tubo de escape  
r.o. 6N0253144

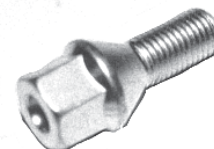

**792**  
tornillo rueda M-12x150x23,5  
r.o. 3A0601139



**3621**  
tapón llenado aceite motor  
r.o. 06A103485F



**674**  
tapón de cárter M-14x150 1.7D-1.9D  
r.o.



**2916**  
tapón de cárter 1.4TDi-1.0-1.4/16v-1.6/16v  
r.o. N90813201

**¡Nuevo!**



**3731**  
interruptor luz de freno (4 polos, SDi)  
r.o. 1J0945511A

**¡Nuevo!**



**3739**  
interruptor luz de freno (2 polos)  
r.o. 191945511A/B



**864**  
cubrepedal freno y embrague  
r.o. 321721173

**SUSPENSION DELANTERA y SOPORTES DE MOTOR:**

1.2/3 cil.-1.4/3 cil.-1.4/16v-1.8/20v-2.0  
1.9SDi - 1.9TDi

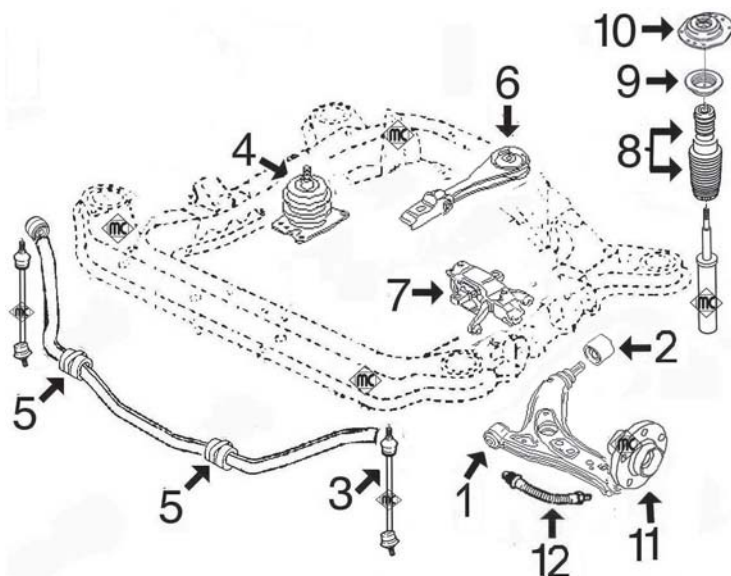

- 1- 4671 silentbloc anterior trapecio delantero
- 2- 4670 silentbloc posterior trapecio delantero
- 3- 4792 bieleta puntal barra estabilizadora completa
- 4- 4786 soporte motor derecho
- 5- 4918 goma barra estabilizadora
- 6- 4804 soporte motor trasero 1.4TDi-1.8/20v
- 4787 soporte motor trasero 1.2-1.4/3cil.-1.4/16v
- 4797 soporte motor trasero 1.9SDi-2.0
- 4804 soporte motor trasero 1.9TDi 5 velocidades
- 4805 soporte motor trasero 1.9TDi 6 velocidades
- 7- 4785 soporte motor izquierdo
- 8- 4765 juego fuelle amortiguador delantero completo con tope de poliuretano
- 9- 4789 rodamiento soporte amortiguador
- 10- 4788 soporte amortiguador delantero completo con rodamiento
- 11- 90100 buje rueda delantera con rodamiento
- 12- 96200 latiguillo freno delantero

**SUSPENSION TRASERA:**

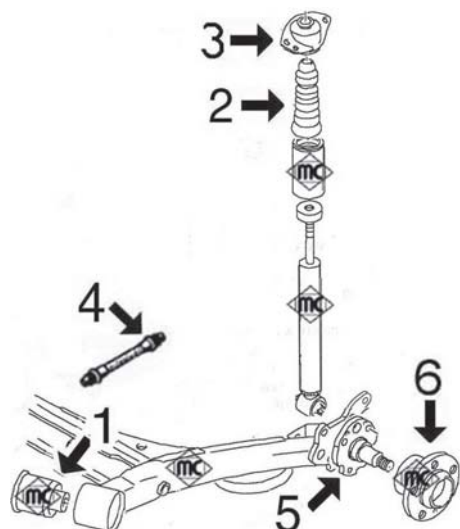

- 1- 4310 silentbloc brazo trasero suspensión
- 2- 4920 tope poliuretano amortiguador trasero
- 3- 4311 soporte amortiguador trasero
- 4- 96014 latiguillo freno trasero
- 5- n/d mangueta rueda trasera
- 6- 90503 buje rueda trasera con rodamiento

VW POLO-3 (2002 - )



**4310**  
silentbloc brazo suspensión trasera  
r.o. 1J0501541C



**4311**  
soporte amortiguador trasero  
r.o. 1J0513353B



**4670**  
silentbloc posterior trapecio delantero  
r.o. 6Q0407183A



**4671**  
silentbloc anterior trapecio delantero  
r.o. 6Q0407151D



**4765**  
juego fuelle amortiguador delantero y tope  
poliuretano, r.o. 6N0412303A-6N0413175A

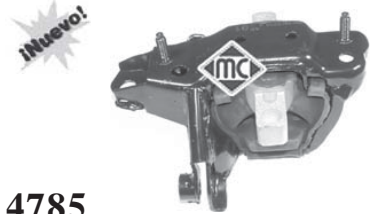

**4785**  
soporte motor izquierdo  
r.o. 6Q0199555AC/AD/AE/K



**4786**  
soporte motor derecho  
r.o. 6Q0199167CB/BM/CC/BC/CA/CD



**4787**  
soporte motor trasero 1.2-1.4-1.4/16v  
r.o. 6Q0199851AB/AE



**4788**  
soporte amortiguador delantero completo  
con rodamiento r.o. 6N0412331E



**4789**  
rodamiento soporte amortiguador delantero  
r.o. 6N0412249C



**4792**  
bioleta puntal barra estabilizadora  
r.o. 6Q0411315F



**4797**  
soporte motor trasero 1.9SDi-2.0  
r.o. 6Q0199851T/M/D



**4804**  
soporte motor trasero 1.9TDi 5 velocidades  
r.o. 6Q0199851AC/B/E/J



**4805**  
soporte motor trasero 1.9TDi 6 velocidades  
r.o. 6Q0199851N



**4918**  
goma barra estabilizadora delantera  
r.o.



**4920**  
tope poliuretano suspensión trasera  
r.o. 6Q0512131B



**90100**  
bujе rueda delantera con rodamiento  
r.o. 6Q0407621AJ

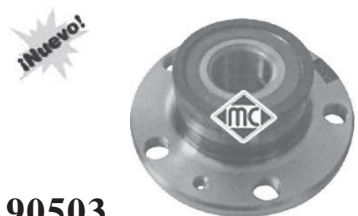

**90503**  
bujе rueda trasera con rodamiento  
r.o. 6Q0598611



**96200**  
latiguillo freno delantero (555 mm)  
r.o. 6Q0611701C



**96014**  
latiguillo freno trasero (165 mm)  
r.o. 6X0611775



VW POLO-3 (2002 - )

**¡Nuevo!**



**3675**  
botella de expansión  
r.o.6Q0121407A

**¡Nuevo!**



**3677**  
tapón botella de expansión  
r.o.3B0121321



**3591**  
brida de agua en culata 1.9SDi  
r.o.038121132C



**3625**  
tubo de agua 1.4/16v  
r.o.6Q0121407A

**¡Nuevo!**

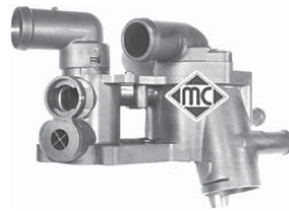

**3693**  
caja de termostato completa 1.4-1.4/16v  
r.o.032121111AP

**¡Nuevo!**

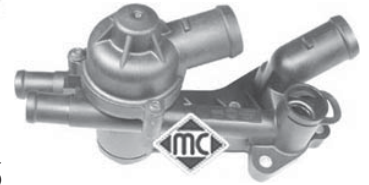

**3726**  
caja termostato completa 1.2 (3 cilindros)  
r.o.03C121111B

**¡Nuevo!**



**3727**  
tubo desvaporizador 1.9Diesel  
r.o.038103493H



**3621**  
tapón llenado aceite motor  
r.o.06B103485B/H

**¡Nuevo!**



**3688**  
guía varilla nivel aceite 1.2  
r.o.036115636



**4355**  
guía varilla nivel aceite 1.4/16v  
r.o.



**3568**  
guía varilla nivel aceite 1.8 gasolina  
r.o.06A103663B



**3571**  
guía varilla nivel aceite 1.9D  
r.o.038103663

**¡Nuevo!**



**3725**  
guía varilla nivel aceite 1.4TDi  
r.o.06A103663A



**3553**  
guía varilla nivel aceite 2.0 gasolina  
r.o.06A103663C

**¡Nuevo!**



**4793**  
varilla nivel aceite 1.4/16v  
r.o.

**¡Nuevo!**



**4794**  
varilla nivel aceite 1.4TDi  
r.o.

**¡Nuevo!**



**4759**  
varilla nivel aceite 1.9Diesel  
r.o.

**¡Nuevo!**



**4795**  
varilla nivel aceite 1.8 gasolina  
r.o.

**¡Nuevo!**



**4492**  
polea cigüeñal 1.4 TDi  
r.o.045105243-045105243B

**¡Nuevo!**



**4494**  
polea cigüeñal 1.9SDi  
r.o.038105243L-038105243M

**¡Nuevo!**



**4480**  
polea cigüeñal 1.9TDi  
r.o.03G105243-038105243L

VW POLO-3 (2002 - )



**4405**  
polea cigueñal 1.8-2.0 gasolina  
r.o. 06A105243E/F

*¡Nuevo!*



**4770**  
tensor correa alternador 1.4/16v  
r.o. 030145299F

*¡Nuevo!*



**4997** Ø 61/55 mm, H=41 mm  
polea alternador de rueda libre  
r.o. 022903119A

*¡Nuevo!*



**5007** Ø 61/55 mm, H=36 mm  
polea alternador de rueda libre  
r.o. 03D903119A

*¡Nuevo!*



**4749**  
casquillo guía embrague  
r.o. 02A141180A

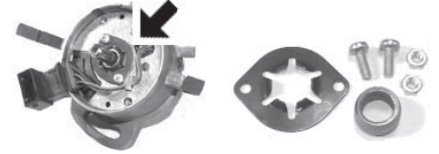

**4296**  
kit reparación distribuidor Magneti-Marelli  
(casquillo sinterizado del eje rotor)

*¡Nuevo!*



**3689**  
válvula filtro gasoil  
r.o. 1J0127247A



**864**  
cubrepedal freno y embrague  
r.o. 321721173

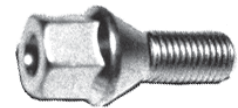

**792**  
tornillo rueda M-12x150x23,5  
r.o. 3A0601139



**2426**  
soporte anterior tubo de escape  
r.o. 6X0253147

*¡Nuevo!*



**4762**  
soporte posterior tubo de escape  
r.o. 6Q0253144G

*¡Nuevo!*



**4917**  
soporte posterior tubo de escape  
r.o. 6Q0253144B/D



**674**  
tapón cárter de aceite 1.2 - 1.9D - 1.8 - 2.0  
r.o. N90288901



**2916**  
tapón cárter de aceite 1.4/16v - 1.4TDi  
r.o. N90813201

*¡Nuevo!*



**3738**  
interruptor luz de freno (4 polos)  
r.o. 1J0945511D/C



**4365**  
juego tornillos fijación tapa motor  
r.o. 028103638G+028103665+028103937

## CANALIZACIONES DE AGUA

SHARAN motores 1.9 TDi y 2.0 gasolina hasta 2000:

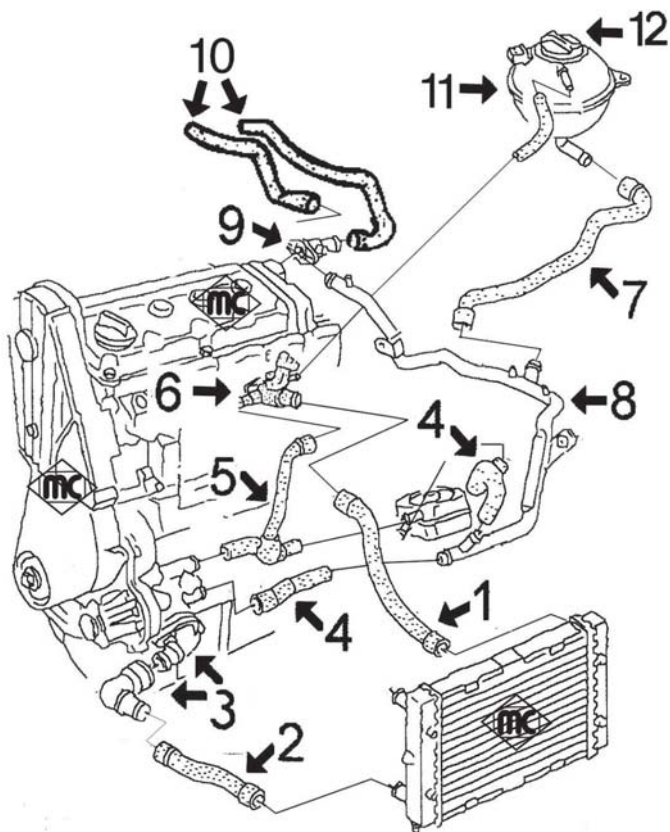

- 1- 8889 mgtto superior radiador
- 2- 8890 mgtto inferior radiador
- 3- 3667 boquilla en bomba de agua hasta '01  
3597 boquilla en bomba de agua desde '01
- 4- 8891 juego mgtos de tubo metálico a intercambiador y de tubo metálico a bomba de agua
- 5- 8394 mgtto de bomba de agua a brida en culata e intercambiador 2.0 gasolina  
8382 mgtto de bomba de agua a brida en culata e intercambiador 1.9TDi de 90cv  
8893 mgtto de bomba de agua a brida en culata e intercambiador 1.9TDi de 110cv
- 6- 3522 brida en culata conexión mgtos 2.0 gasolina  
3542 brida en culata conexión mgtos 1.9TDi
- 7- 8894 mgtto de tubo metálico a botella
- 8- 3170 tubo de agua metálico 2.0 gasolina  
3168 tubo de agua metálico 1.9TDi
- 9- 3517 boquilla en culata hasta '00  
3591 boquilla en culata 1.9TDi desde '00
- 10- 8892 juego mgtos entrada/salida calefactor
- 11- 3649 botella de expansión
- 12- 3650 tapón botella de expansión

## MANGUITOS DESVAPORIZADORES 1.9TDi y 2.0 gasolina

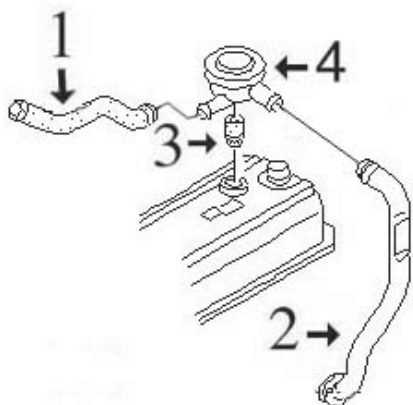

- 1- 8895 mgtto desvaporizador
- 2- 3644 tubo plástico desvaporizador 1.9TDi  
n/d tubo plástico desvaporizador 2.0 gasolina
- 3- 2669 junta válvula desvaporizadora
- 4- 3719 válvula desvaporizadora

## VOLKSWAGEN SHARAN

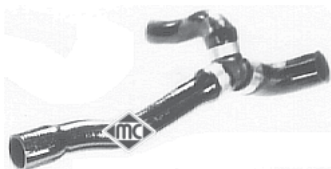

**8382**  
mgto de bomba a brida en culata 1.9TDi de 90cv, r.o.



**8394**  
mgto de bomba a brida en culata 2.0 r.o.



**8889**  
mgto superior radiador 1.9TDi y 2.0 r.o.



**8890**  
mgto inferior radiador 1.9TDi y 2.0 r.o.



**8891**  
jgo mgto de tubo metálico a bomba de agua y a intercambiador, r.o.



**8892**  
jgo mgto entrada/salida calefactor r.o.



**8893**  
mgto de bomba a brida en culata 1.9TDi de 110cv, r.o.



**8894**  
mgto de tubo metálico a botella expansión r.o.



**8895**  
mgto desvaporizador 1.9TDi y 2.0 r.o.

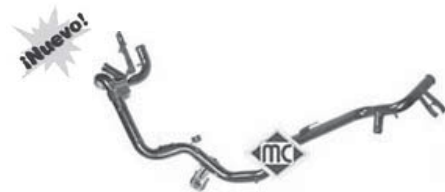

**3168**  
tubo de agua metálico 1.9TDi r.o. 7M0121065AA/AE



**3170**  
tubo de agua metálico 2.0 gasolina r.o. 7M0121065AF



**3517**  
boquilla en culata 2.0 y 1.9TDi hasta '00 r.o. 026121145E



**3522**  
brida frontal en culata 2.0 gasolina r.o. 037121133F-037121132E-037121132G



**3542**  
brida frontal en culata 1.9TDi r.o. 028121132A-028121132



**3591**  
boquilla en culata 1.9TDi desde '00 r.o. 038121132C



**3597**  
boquilla en culata 2.0 y 1.9TDi desde '00 r.o. 06A121121C



**3644**  
tubo plástico desvaporizador 1.9Diesel r.o. 028103491J



**3649**  
botella de expansión r.o. 7M0121407A-7M3121407A



**3650**  
tapón botella de expansión r.o. 7M0121321C-7M3121321C



**3667**  
boquilla en bomba de agua completa r.o. 037121619+037121121A



**3719**  
válvula desvaporizadora 1.9TDi-2.0 r.o. 028129101D



# VOLKSWAGEN SHARAN



## CANALIZACIONES de AIRE de ALTA PRESION INTERCOOLER-TURBO:

SHARAN 1.9 Diesel motores TDi desde 9/'95 a 2/'00:  
(AHU-1Z-AFN-AVG)

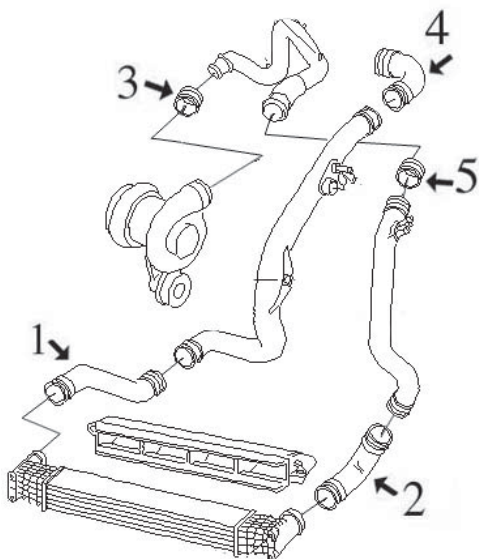

- 1- n/d tubo flexible de tubo a intercooler
- 2- n/d tubo flexible de tubo a intercooler
- 3- 9062 tubo flexible de turbo a tubo rígido
- 4- n/d tubo de colector a tubo rígido
- 5- 9061 tubo flexible de empalme

**¡Nuevo!**



**9061**

Ø 50x60 largo 58 mm

tubo flexible de alta presión

r.o.1H0145834E

**¡Nuevo!**



**9062**

Ø 35x45 largo 58 mm

tubo flexible de alta presión

r.o.3A0145972A

## VOLKSWAGEN SHARAN

### SUSPENSION DELANTERA y SOPORTES DE MOTOR:

SHARAN todos tipos desde '96 hasta '01:

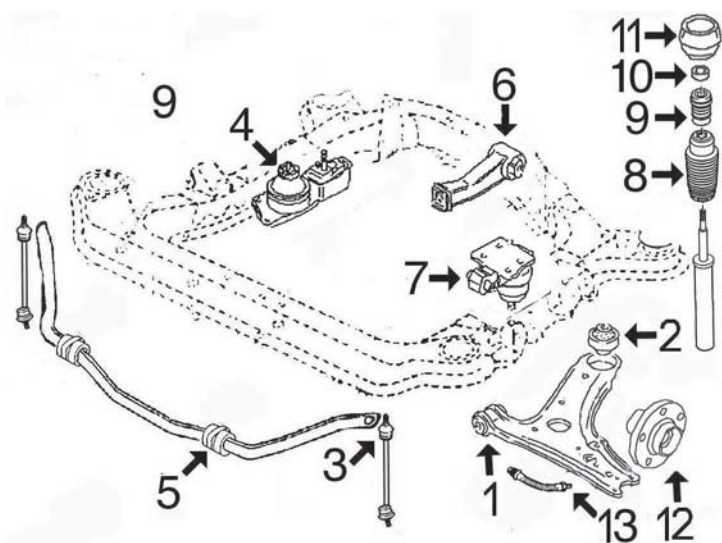

- 1- 4279 silentbloc anterior trapecio delantero
- 2- 4280 silentbloc posterior trapecio delantero
- 3- 4261 bieleta puntal barra estabilizadora
- 4- 4556 soporte motor derecho
- 5- 4555 goma barra estabilizadora
- 6- 4559 soporte motor trasero 1.9TDi de 90cv y 2.0  
4560 soporte motor trasero 1.9TDi de 110cv y 1.8T
- 7- 4557 soporte motor izquierdo
- 8- 4324 capuchón amortiguador delantero
- 9- 4254 tope poliuretano amortiguador delantero
- 10- 4128 rodamiento soporte amortiguador
- 11- 2812 soporte amortiguador completo con rodamiento
- 12- 90064 buje rueda delantera
- 13- 96069 latiguillo freno delantero (500 mm)

SHARAN todos tipos desde '01:

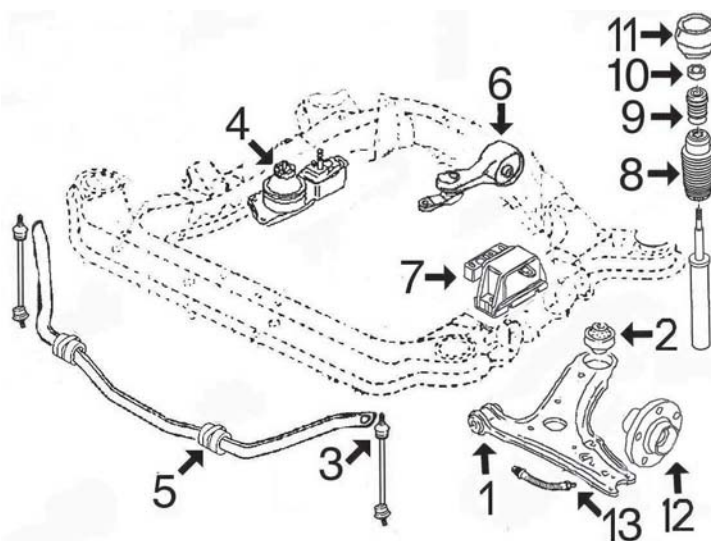

- 1- 4279 silentbloc anterior trapecio delantero
- 2- 4280 silentbloc posterior trapecio delantero
- 3- 4261 bieleta puntal barra estabilizadora
- 4- 4556 soporte motor derecho
- 5- 4555 goma barra estabilizadora
- 6- 4561 soporte motor trasero
- 7- 4558 soporte motor izquierdo
- 8- 4324 capuchón amortiguador delantero
- 9- 4298 tope poliuretano amortiguador delantero
- 10- 4128 rodamiento soporte amortiguador
- 11- 2812 soporte amortiguador completo con rodamiento
- 12- 90064 buje rueda delantera
- 13- 96069 latiguillo freno delantero (500 mm)

### SUSPENSION TRASERA:

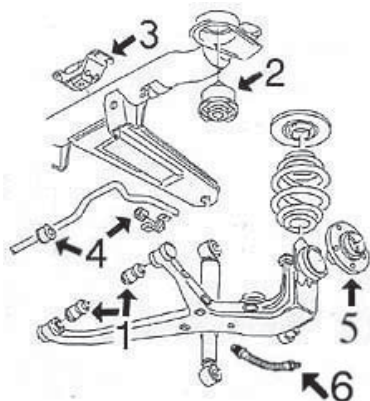

- 1- 4279 silentbloc trapecio suspensión trasera
- 2- n/d silentbloc sub-chasis trasero
- 3- 4603 soporte travesía suspensión trasera
- 4- 4618 juego gomas barra estabilizadora trasera
- 5- 90064 buje rueda trasera
- 6- 96070 latiguillo freno trasero (185 mm)

# VOLKSWAGEN SHARAN



**4128**  
rodamiento soporte amortiguador delantero  
r.o. 1J0412249



**2812**  
soporte amortiguador delantero completo  
r.o. 357412331A+1J0412249



**4254**  
tope poliuretano amortiguador delantero  
hasta '01, r.o. 357412303F



**4261**  
bieleta puntal barra estabilizadora  
r.o. 7M0411317D



**4279**  
silentbloc anterior trapecio delantero y sus-  
pensión trasera, r.o. 7M0501541



**4280**  
silentbloc posterior trapecio delantero  
r.o. 7M0407181A



**4298**  
tope poliuretano amortiguador delantero  
r.o. 1H0412303B



**4324**  
capuchón amortiguador delantero  
r.o. 357413175A



**4555**  
goma barra estabilizadora delantera  
r.o. 7M0411031



**4556**  
soporte motor derecho  
r.o. 7M0199132AH/AA/M/T/R



**4557**  
soporte motor izquierdo hasta '01  
r.o. 7M0199131AP/AF



**4558**  
soporte motor izquierdo desde '01  
r.o. 7M3199555B/R/K



**4559**  
soporte motor trasero 1.9TDi (90cv) y 2.0  
r.o. 7M0399201BR/BT



**4560**  
soporte motor trasero 1.9TDi (110cv) y 1.8T  
r.o. 7M0399201BQ/CC



**4561**  
soporte motor trasero todos desde '01  
r.o. 7M3399201H/J/K/G



**4603**  
soporte traviesa suspensión trasera  
r.o. 7M0555221C



**4618**  
juego gomas barra estabilizadora trasera  
r.o. 7M0511413A+7M0555414B



**90064**  
buje rueda delantera y trasera  
r.o. 7M0501655D



**96069**  
latiguillo freno delantero (500 mm)  
r.o. 7M0611701D



**96070**  
latiguillo freno trasero (185 mm)  
r.o. 7M0611776B/C

# VOLKSWAGEN SHARAN



**1321**  
fuelle izqdo. y dcho. cremallera  
r.o. 7M3422831



**1225**  
kit fuelle transmisión lado rueda  
r.o. 7M0498203-7M0498203A



**1069**  
kit fuelle transmisión lado cambio  
r.o. 7M0498201



**3568**  
guía varilla nivel aceite 1.8T  
r.o. 06A103663B

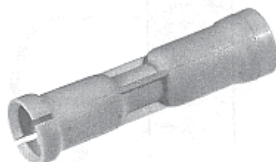

**2448**  
guía varilla nivel aceite 2.0 hasta '99  
r.o. 053103663



**3553**  
guía varilla nivel aceite 2.0 desde '99  
r.o. 06A103663C



**2876**  
guía varilla nivel aceite 1.9 TDi (salvo ANU)  
r.o. 028103663B



**3571**  
guía varilla nivel aceite 1.9 TDi (ANU)  
r.o. 038103663



**4760**  
varilla nivel aceite 1.9TDi-2.0  
r.o. 027115611C



**4290**  
polea cigüeñal 1.9 D-TD-TDi hasta '99  
r.o. 028105243T



**4421**  
polea cigüeñal 1.9 TDi desde '99-  
r.o. 038105243K

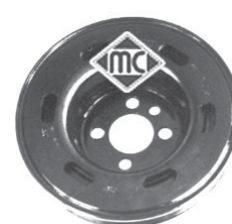

**4405**  
polea cigüeñal 1.8T-2.0 gasolina  
r.o. 06A105243E



**4768** Ø 78 mm  
rodillo tensor correa alternador 1.9TDi-2.0  
r.o. 028145278E

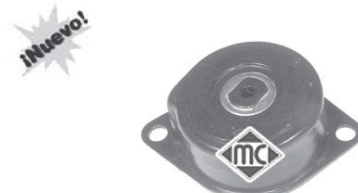

**4908**  
tensor correa alternador 1.9TDi hasta '99  
r.o. 028903315R



**4909**  
tensor correa alternador 2.0 gasolina  
hasta '99, r.o. 037903315C

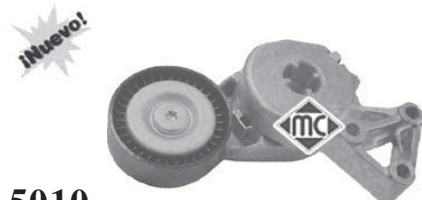

**5010**  
tensor correa alternador 1.8 desde '00-  
r.o. 06A903315E



**4919** Ø 55/50 mm, H=40,5 mm  
polea de alternador de rueda libre  
r.o. 028903119AA



**4999** Ø 61/55 mm, H=41 mm  
polea de alternador de rueda libre  
r.o. 038903119



**4997** Ø 61/55 mm, H=41 mm  
polea de alternador de rueda libre  
r.o. 038903119T



**3672**  
válvula filtro gasoil 1.9D hasta '99  
r.o. 191127247A



**3689**  
válvula filtro gasoil 1.9D desde '99  
r.o. 1J0127247-247A -247E



## VOLKSWAGEN SHARAN



**4365**

jgo. tornillo sujeción tapa cubremotor  
r.o.028103665+028103937+028103638G



**864**

cubrepedal freno y embrague  
r.o.321721173



**2669**

junta válvula desvaporizadora  
r.o.028103500

**¡Nuevo!**



**3731**

interruptor luz de freno (4 polos) hasta 12/'02  
r.o. 1J0945511A

**¡Nuevo!**



**3739**

interruptor luz de freno (2 polos)  
r.o. 191945511A/B

**¡Nuevo!**

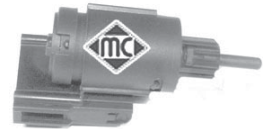

**3738**

interruptor luz de freno (4 polos) desde  
12/'02, r.o. 1J0945511C/D



**2426**

sopORTE tubo de escape  
r.o. 1H0253147B



**674**

tapón cárter de aceite hasta '98 (salvo V6)  
r.o. N90288901



**2916**

tapón cárter de aceite desde '98 (salvo V6)  
r.o. N90813201



**2780**

junta colector escape 1.9 TDi  
r.o.028129589B

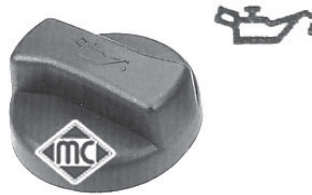

**3621**

tapón llenado aceite motor  
r.o.06B103485B

# VOLKSWAGEN TRANSPORTER

## CANALIZACIONES DE AGUA:

**TRANSPORTER** motores 1.9 D-TD desde 9/'90 hasta 4/'96 con o sin aire acondicionado  
 motores 1.9 D-TD desde '4/'96 hasta 6/'03 sin aire acondicionado  
 motor 2.0 gasolina desde 9/'90 hasta 4/'96 con o sin aire acondicionado

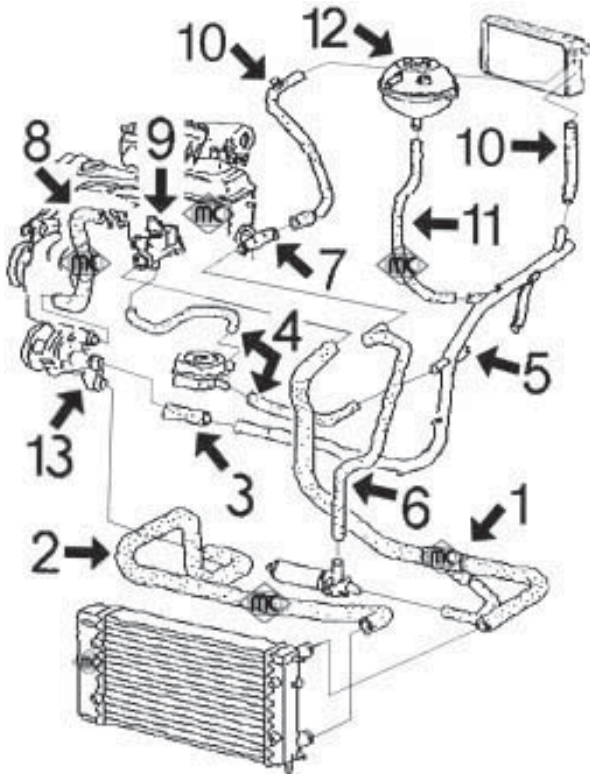

- 1- 8999 mgto superior radiador
- 2- 8922 mto inferior radiador
- 3- 7581 mgto de tubo metálico a bomba de agua
- 4- 9016 jgo. mgto intercambiador
- 5- 3180 tubo de agua metálico
- 6- 9015 mgto de bomba auxiliar a boquilla en culata
- 7- 3612 brida de agua en culata (plástico)
- 8- 7917 mgto de bomba de agua a brida frontal en bloque
- 9- 3527 brida de agua frontal 1.9D-TD  
3522 brida de agua frontal 2.0 gasolina
- 10- 9000 jgo. mgto entrada/salida calefactor
- 11- 9018 mgto de botella a tubo metálico
- 12- 3634 botella de expansión  
3506 tapón botella de expansión
- 13- 3536 tapa de termostato

**TRANSPORTER** motores 1.9D-TD desde 4/'96 hasta 6/'03 con aire acondicionado  
 motor 2.0 gasolina desde 4/'96 hasta 6/'03 con o sin aire acondicionado

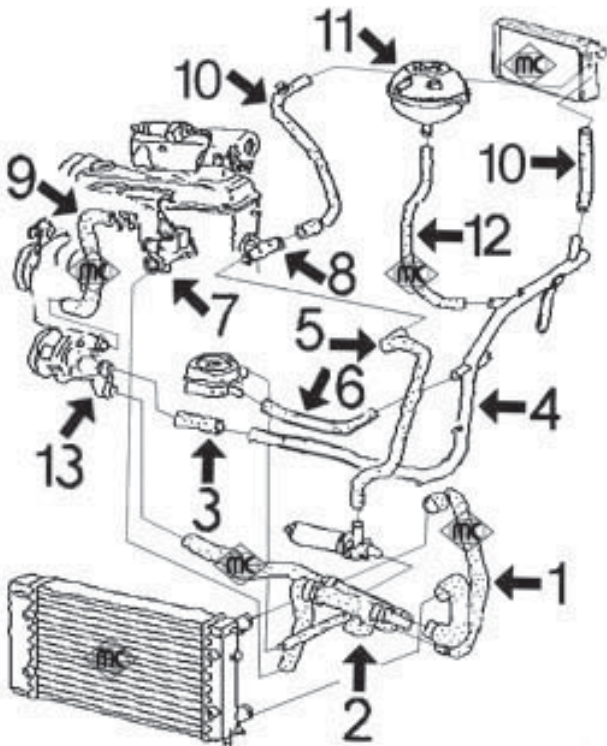

- 1- 9026 mgto doble superior/inferior radiador 1er. tramo
- 2- 9024 mgto doble superior/inferior radiador 2º tramo
- 3- 7581 mgto de tubo metálico a bomba de agua
- 4- 3180 tubo de agua metálico
- 5- 9015 mgto de bomba auxiliar a boquilla en culata
- 6- 9016 jgo. mgto intercambiador
- 7- 3612 boquilla en culata (plástico)
- 8- 3527 brida de agua frontal 1.9D-TD-TDi  
3522 brida de agua frontal 2.0 gasolina
- 9- 7917 mgto de bomba de agua a brida frontal en bloque
- 10- 9000 jgo. mgto entrada/salida calefactor
- 11- 3634 botella de expansión  
3506 tapón botella de expansión hasta '02  
3677 tapón botella de expansión desde '02
- 12- 9018 mgto de botella a tubo metálico
- 13- 3536 tapa de termostato

# VOLKSWAGEN TRANSPORTER

## TRANSPORTER motor 2.4 D desde 9/'90 hasta 4/'97

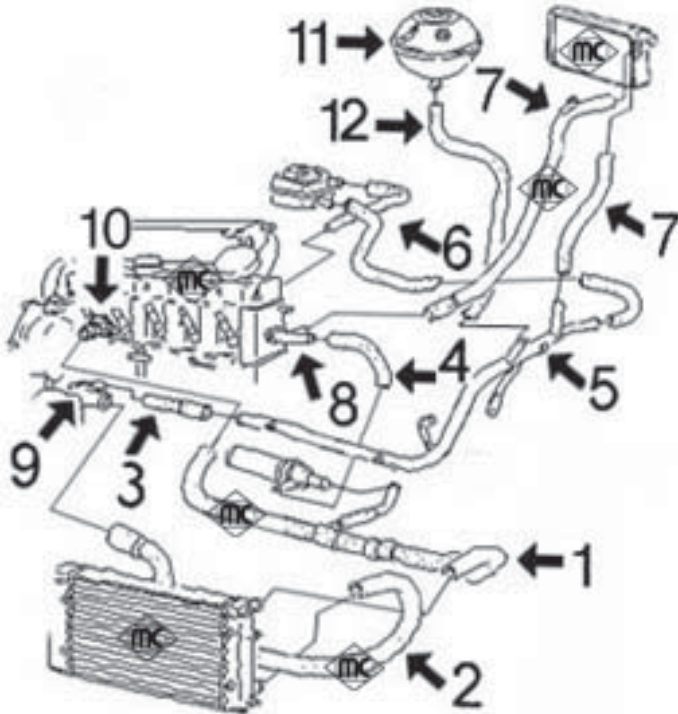

- 1- 9023 mgto superior radiador
- 2- 9022 mgto inferior radiador
- 3- 9017 mgto de tubo metálico a bomba de agua
- 4- 9021 mgto de brida en culata a bomba auxiliar
- 5- 3181 tubo de agua metálico
- 6- 9019 jgo. mgto intercambiador
- 7- 9020 jgo. mgto entrada/salida calefactor
- 8- 3603 brida de agua en culata (plástico)
- 9- 3686 tapa de termostato
- 10- 3602 brida de agua frontal (plástico)
- 11- 3634 botella de expansión  
3506 tapón botella de expansión
- 12- 9018 mgto de botella a tubo metálico

## TRANSPORTER motor 2.5 TDi desde 4/'97 hasta 6/'03

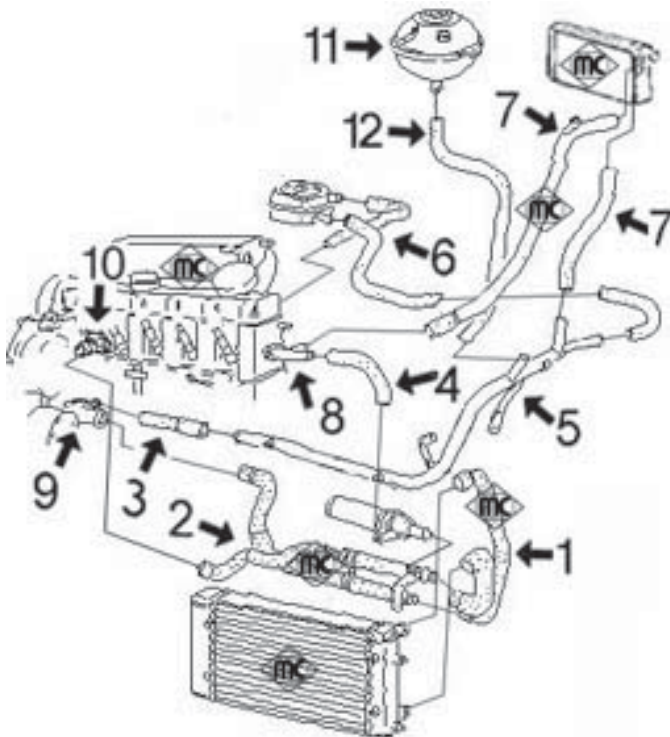

- 1- 9026 mgto doble superior/inferior radiador 1er. tramo
- 2- 9025 mgto doble superior/inferior radiador 2º tramo
- 3- 9017 mgto de tubo metálico a bomba de agua
- 4- 9021 mgto de brida en culata a bomba auxiliar
- 5- 3181 tubo de agua metálico
- 6- 9019 jgo. mgto intercambiador
- 7- 9020 jgo. mgto entrada/salida calefactor
- 8- 4755 brida de agua en culata (aluminio)
- 9- 3686 tapa de termostato
- 10- 3602 brida de agua frontal (plástico)
- 11- 3634 botella de expansión  
3506 tapón botella de expansión hasta '02  
3677 tapón botella de expansión desde '02
- 12- 9018 mgto de botella a tubo metálico



## TUBOS DESVAPORIZADORES

motores 1.9 D y TD:

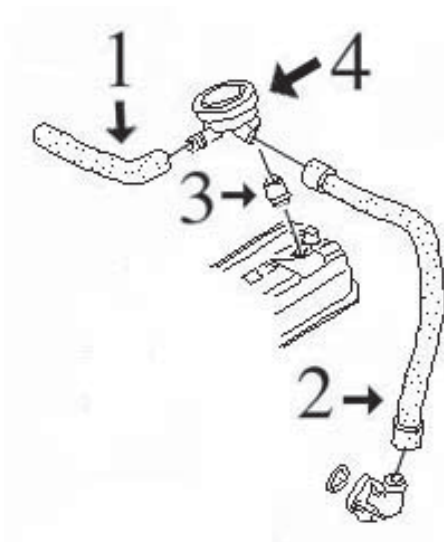

motores 2.4 D y 2.5 TDi:

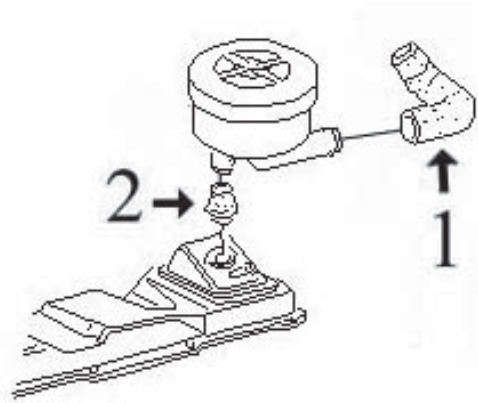

- 1- 9040 mgto de válvula a tapa 1.9D
- 9041 mgto de válvula a tapa 1.9TD
- 2- 9029 mgto de válvula a base motor 1.9D-TD
- 3- 2669 junta válvula desvaporizadora
- 4- 3719 válvula desvaporizadora

- 1- 9028 mgto de válvula a tapa 2.4D
- 9027 mgto de válvula a tapa 2.5TDi
- 2- 2669 junta válvula desvaporizadora



**7581**

mgto de tubo metálico a bomba 1.9D-TD-2.0  
r.o.044121063A



**7917**

mgto de bomba a conector en bloque  
r.o.028121053N



**8922**

mgto inferior radiador 1.9D-TD-2.0  
r.o.



**8999**

mgto superior radiador 1.9D-TD-2.0  
r.o.



**9000**

jgo. mgtos calefactor 1.9D-TD-2.0  
r.o.











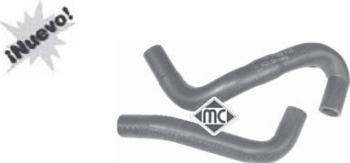







**9015**

mgto de bomba auxiliar a boquilla en culata  
r.o.



# VOLKSWAGEN TRANSPORTER

<p><b>9016</b> jgo. mgts intercambiador 1.9D-TD r.o.</p> 	<p><b>9017</b> mgto de tubo metálico a bomba 2.4D-2.5TDi r.o.</p> 	<p><b>9018</b> mgto de botella a tubo metálico r.o.</p> 
<p><b>9019</b> jgo. mgts intercambiador 2.4D-2.5TDi r.o.</p> 	<p><b>9020</b> jgo. mgts calefactor 2.4D-2.5TDi r.o.</p> 	<p><b>9021</b> mgto de boquilla en culata a bomba auxiliar r.o.</p> 
<p><b>9022</b> mgto inferior radiador 2.4D r.o.</p> 	<p><b>9023</b> mgto superior radiador 2.4D r.o.</p> 	<p><b>9024</b> mgto doble sup/inf 1.9D-TD 1er. tramo r.o.</p> 
<p><b>9025</b> mgto doble sup/inf 2.5TDi 2º tramo r.o.</p> 	<p><b>9026</b> mgto doble sup/inf 2.5TDi 1er. tramo r.o.</p> 	<p><b>9027</b> mgto desvaporizador 2.5TDi r.o.</p> 
<p><b>9028</b> mgto desvaporizador 2.4D r.o.</p> 	<p><b>9029</b> mgto desvaporizador 1.9D-TD r.o.</p> 	<p><b>9040</b> mgto desvaporizador 1.9D r.o.</p> 
<p><b>9041</b> mgto desvaporizador 1.9TD r.o.</p> 		

## VOLKSWAGEN TRANSPORTER

  <p><b>2669</b> junta válvula desvaporizadora todos r.o.028103500</p>	 <p><b>3180</b> tubo de agua metálico 1.9D-TD-2.0 r.o.</p>	
 <p><b>3181</b> tubo de agua metálico 2.4D-2.5TDi r.o.</p>	 <p><b>3506</b> tapón botella de expansión r.o. 1H0121321A</p>	 <p><b>3522</b> conector frontal en bloque 2.0 gasolina r.o.037121133F-037121132E-037121132G</p>
 <p><b>3527</b> conector frontal en bloque 1.9D-TD r.o.068121133AB-068121133AE</p>	 <p><b>3536</b> tapa de termostato 1.9D-TD-2.0 r.o.055121121F</p>	 <p><b>3602</b> conector frontal en bloque 2.4D-2.5TDi r.o.074121132</p>
 <p><b>3603</b> boquilla conector en culata 2.4D r.o.074121143D</p>	 <p><b>3612</b> boquilla conector en culata 1.9D-TD-2.0 r.o.044121144B</p>	 <p><b>3634</b> botella de expansión todos mods. hasta '03 r.o.701121407B</p>
 <p><b>3686</b> tapa de termostato 2.4D-2.5TDi r.o.074121121B</p>	 <p><b>3719</b> válvula desvaporizadora 1.9D-TD-TDi r.o.028129101D</p>	 <p><b>3677</b> tapón botella de expansión desde '03- r.o.3B0121321</p>
 <p><b>4755</b> boquilla en culata 2.5TDi r.o.074121145B</p>		

# VOLKSWAGEN TRANSPORTER

## SUSPENSION DELANTERA y SOPORTES DE MOTOR

TRANSPORTER todos modelos desde 9/'90 hasta 4/'96

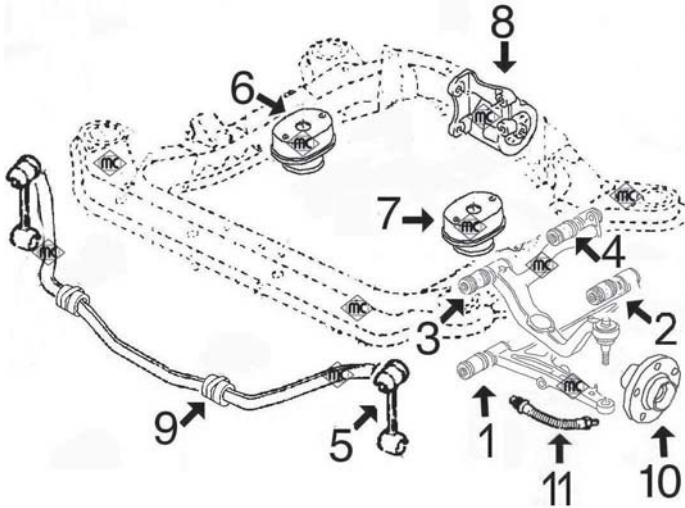

- 1- 4259 silentbloc anterior trapecio inferior delantero hasta '93 (eje de Ø 12 mm)
- 4305 silentbloc anterior trapecio inferior delantero desde '93 (eje de Ø 14 mm)
- 2- 4260 silentbloc posterior trapecio inferior delantero
- 3- 4307 silentbloc anterior trapecio superior delantero
- 4- 4306 silentbloc posterior trapecio superior delantero
- 5- 4314 bieleta puntal barra estabilizadora
- 6- 4356 soporte motor derecho
- 7- 4356 soporte motor izquierdo
- 8- 4357 soporte motor trasero (salvo automáticos)
- 9- 4175 goma barra estabilizadora
- 10- 90096 buje rueda delantera (y trasera)
- 11- 96192 latiguillo freno delantero (370 mm)

TRANSPORTER todos modelos desde 4/'96 hasta 6/'03

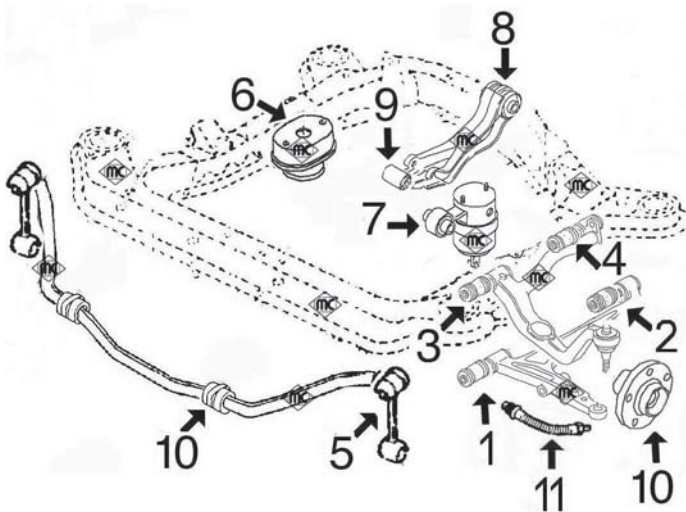

- 1- 4305 silentbloc anterior trapecio inferior delantero
- 2- 4260 silentbloc posterior trapecio inferior delantero
- 3- 4307 silentbloc anterior trapecio superior delantero
- 4- 4306 silentbloc posterior trapecio superior delantero
- 5- 4335 bieleta puntal barra estabilizadora (con rótula)
- 6- 4371 soporte motor derecho 1.9TD-2.0 y 2.5 gasolina
- 4371 soporte motor derecho 2.5 TDi hasta '99
- 4751 soporte motor dcho. 2.4D todos y 2.5TDi desde '99
- 7- 4750 soporte motor izquierdo 1.9D/TD y 2.4D
- 4750 soporte motor izquierdo 2.0-2.5 gasolina
- 4764 soporte motor izquierdo 2.5 TDi con cambio manual
- 4764 soporte motor izqdo. cambio automático todos mods.
- 8- 4325 silentbloc posterior soporte motor trasero todos
- 9- 4358 silentbloc anterior soporte motor trasero
- 10- 4175 goma barra estabilizadora
- 11- 90096 buje rueda delantera (y trasera)
- 11- 96192 latiguillo freno delantero (370 mm)

## VOLKSWAGEN TRANSPORTER



**4175**  
goma barra estabilizadora  
r.o. 701411041

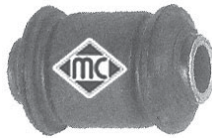

**4259**  
silentbloc anterior trapecio inferior delant.  
hasta '93, r.o. 701407183

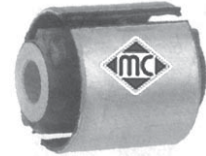

**4260**  
silentbloc posterior trapecio inferior delt.  
r.o. 701407140B/C



**4305**  
silentbloc anterior trapecio inferior delantero  
desde '93, r.o. 7D0407183



**4306**  
silentbloc posterior trapecio superior delt.  
r.o. 701407083



**4307**  
silentbloc anterior trapecio superior delt.  
r.o. 701407077-701407077A



**4314**  
bieleta puntal barra estabilizadora hasta '96  
r.o. 7D0411049



**4325**  
silentbloc posterior soporte motor trasero  
desde '96, r.o. ---



**4335**  
bieleta puntal barra estabilizadora desde  
'96, r.o. 701411049B



**4356**  
soporte motor derecho e izquierdo hasta '96  
r.o. 701199201G/H

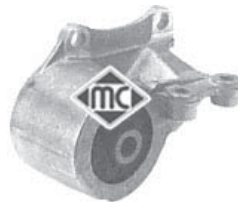

**4357**  
soporte motor trasero hasta '96  
r.o. 701399201AG

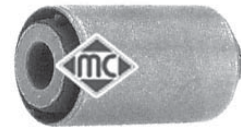

**4358**  
silentbloc anterior soporte motor trasero  
desde '96, r.o. 701399661



**4371**  
soporte motor derecho 1.9TD-2.0-2.5(gasolina)  
desde '96 y 2.5TDi-'99, r.o. 7D0199132E

**¡Nuevo!**



**4750**  
soporte motor izquierdo 1.9D/TD-2.4D y 2.0  
gasolina desde '96, r.o. 7D0399107AD

**¡Nuevo!**



**4751**  
soporte motor derecho 2.4D-2.5TDi '99-  
r.o. 7D0199132D

**¡Nuevo!**



**4764**  
soporte motor izquierdo 2.5TDi  
r.o. 7D0399107AL

**¡Nuevo!**

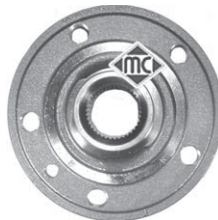

**90096**  
buje rueda delantera y trasera todos mods.  
r.o. 7D0501647A















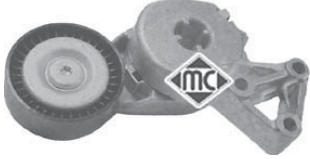

**96192**  
latiguillo freno delantero (370 mm)  
r.o. 701611701-7D0611701C



**96108**  
latiguillo freno trasero (160 mm)  
r.o. 171611775



# VOLKSWAGEN TRANSPORTER

<p><b>¡Nuevo!</b></p>  <p><b>4754</b> varilla nivel aceite todos modelos r.o.044115611F-074115611H</p>	<p><b>¡Nuevo!</b></p>  <p><b>4768</b>      <b>Ø 78 mm</b> rodillo tensor correa alternador 1.9D-2.0-2.4D-2.5D,r.o.028145278E</p>	<p><b>¡Nuevo!</b></p>  <p><b>4756</b>      <b>Ø 90 mm</b> rodillo tensor correa alternador 2.4D-2.5D r.o.074145278E</p>
<p><b>¡Nuevo!</b></p>  <p><b>4922</b>      <b>Ø 17x70 mm</b> rodillo en tensor correa alternador 1.9Diesel r.o.</p>	<p><b>¡Nuevo!</b></p>  <p><b>4908</b> tensor correa alternador 1.9D-TD-TDi-2.4D-2.5TDi,r.o.028903315R</p>	<p><b>¡Nuevo!</b></p>  <p><b>4909</b> tensor correa alternador 2.0 gasolina hasta '98,r.o.037903315C</p>
<p><b>¡Nuevo!</b></p>  <p><b>5010</b> tensor correa alternador 2.0 desde '98- r.o.06A903315E</p>	<p><b>¡Nuevo!</b></p>  <p><b>4919</b>      <b>Ø 55 mm</b> polea de alternador de rueda libre r.o.028903119AA</p>	<p><b>¡Nuevo!</b></p>  <p><b>4997</b>      <b>Ø 61/55 mm, H=41 mm</b> polea de alternador de rueda libre r.o.022903119A</p>
<p><b>¡Nuevo!</b></p>  <p><b>4998</b>      <b>Ø 73,5/67,5 mm, H=40 mm</b> polea de alternador de rueda libre r.o.074903119E-021903119H</p>	<p><b>¡Nuevo!</b></p>  <p><b>4749</b> guía embrague con retén r.o.02A141180A</p>	<p><b>¡Nuevo!</b></p>  <p><b>864</b> cubrepedal freno y embrague r.o.321721173</p>
<p><b>¡Nuevo!</b></p>  <p><b>4753</b> jgo. casquillos palanca de cambio completo r.o.</p>	<p><b>¡Nuevo!</b></p>  <p><b>1062</b> fuelle cremallera dirección r.o.</p>	<p><b>¡Nuevo!</b></p>  <p><b>1187</b> kit fuelle transmisión lado rueda hasta '98 r.o.701498203</p>
<p><b>¡Nuevo!</b></p>  <p><b>1225</b> kit fuelle transmisión lado rueda desde '98 r.o.701498203A</p>	<p><b>¡Nuevo!</b></p>  <p><b>1069</b> kit fuelle transmisión lado cambio r.o.701498201</p>	<p><b>¡Nuevo!</b></p>  <p><b>2308</b> kit fuelle transm. lado cambio completo (Ø 22-107 mm), r.o.</p>
<p><b>¡Nuevo!</b></p>  <p><b>4290</b> polea cigueñal 1.9D-1.9TD-TDi hasta '03 r.o.028105243T/K</p>	<p><b>¡Nuevo!</b></p>  <p><b>4421</b> polea cigueñal 1.9D1.9TDi desde '03 r.o.038105243K</p>	

## VOLKSWAGEN TRANSPORTER

<p><b>¡Nuevo!</b></p>  <p><b>3672</b> válvula filtro gasoil 1.9D/TD-2.4D-2.5TDi r.o.191127247A</p>	 <p><b>2653</b> soporte escape hasta '91 r.o.033251393</p>	 <p><b>497</b> soporte delantero escape desde '91 r.o.8A0253147A</p>
 <p><b>2425</b> soporte escape hasta '97 r.o.1H0253144C</p>	 <p><b>4272</b> soporte escape desde '97 r.o.701253144B</p>	 <p><b>2780</b> junta colector escape 1.9D-TD r.o.028129589B</p>
<p><b>¡Nuevo!</b></p>  <p><b>3731</b> interruptor luz de freno (4 polos) r.o.1J0945511A</p>	<p><b>¡Nuevo!</b></p>  <p><b>3739</b> interruptor luz de freno (2 polos) r.o.191945511A/B</p>	  <p><b>3636</b> tapón llenado aceite motor todos mods. r.o.070115311</p>
 <p><b>759</b> tapón cárter 2.4D-2.5TDi (26x150) r.o.059103193</p>	 <p><b>674</b> tapón cárter 1.9D-TD-2.0 (14x150) r.o.N90288901</p>	